



STGD10NC60H

N-channel 10A - 600V - DPAK
Very fast PowerMESH™ IGBT

Features

Type	V _{CE(S)}	V _{CE(sat)} (Max)@ 25°C	I _C @100°C
STGD10NC60H	600V	< 2.5V	10A

- Low on-voltage drop (V_{cesat})
- Low C_{RES} / C_{IES} ratio (no cross-conduction susceptibility)

Description

Using the latest high voltage technology based on a patented strip layout, STMicroelectronics has designed an advanced family of IGBTs, the PowerMESH™ IGBTs, with outstanding performances. The suffix "H" identifies a family optimized for high frequency applications in order to achieve very high switching performances (reduced t_{fall}) maintaining a low voltage drop.

Applications

- High frequency motor controls
- SMPS and PFC in both hard switch and resonant topologies
- Motor drivers

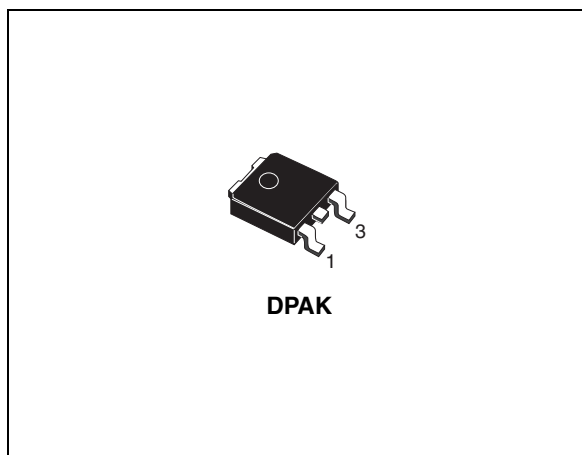

Internal schematic diagram

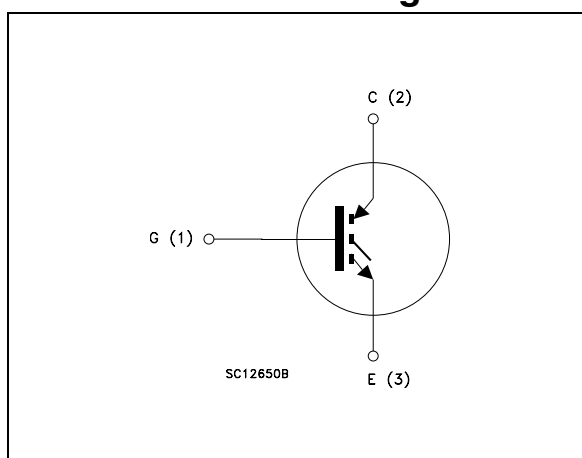

Order code

Part number	Marking	Package	Packaging
STGD10NC60H	GD10NC60H	DPAK	Tape & reel

Contents

1	Electrical ratings	3
2	Electrical characteristics	4
2.1	Electrical characteristics (curves)	6
3	Test circuits	9
4	Package mechanical data	10
5	Packaging mechanical data	12
6	Revision history	13

1 Electrical ratings

Table 1. Absolute maximum ratings

Symbol	Parameter	Value	Unit
V_{CES}	Collector-emitter voltage ($V_{GS} = 0$)	600	V
$I_C^{(1)}$	Collector current (continuous) at $T_C = 25^\circ\text{C}$	20	A
$I_C^{(1)}$	Collector current (continuous) at $T_C = 100^\circ\text{C}$	10	A
$I_{CL}^{(2)}$	Collector current (pulsed)	40	A
V_{GE}	Gate-emitter voltage	± 20	V
P_{TOT}	Total dissipation at $T_C = 25^\circ\text{C}$	60	W
T_j	Operating junction temperature	- 55 to 150	$^\circ\text{C}$

1. Calculated according to the iterative formula:

$$I_C(T_C) = \frac{T_{JMAX} - T_C}{R_{THJ-C} \times V_{CESAT(MAX)}(T_C, I_C)}$$

2. $V_{clamp}=480\text{V}$, $T_j=150^\circ\text{C}$, $R_G=10\Omega$, $V_{GE}=15\text{V}$

Table 2. Thermal resistance

Symbol	Parameter	Value	Unit
Rthj-case	Thermal resistance junction-case max	2.08	$^\circ\text{C}/\text{W}$
Rthj-amb	Thermal resistance junction-ambient max	62.5	$^\circ\text{C}/\text{W}$

2 Electrical characteristics

($T_{CASE}=25^{\circ}\text{C}$ unless otherwise specified)

Table 3. Static

Symbol	Parameter	Test conditions	Min.	Typ.	Max.	Unit
$V_{BR(CES)}$	Collector-emitter breakdown voltage	$I_C = 1\text{mA}$, $V_{GE} = 0$	600			V
I_{CES}	Collector cut-off current ($V_{GE} = 0$)	$V_{CE} = \text{Max rating}$, $T_C = 25^{\circ}\text{C}$ $V_{CE} = \text{Max rating}$, $T_C = 125^{\circ}\text{C}$			150 1	μA mA
I_{GES}	Gate-emitter leakage current ($V_{CE} = 0$)	$V_{GE} = \pm 20\text{V}$, $V_{CE} = 0$			± 100	nA
$V_{GE(th)}$	Gate threshold voltage	$V_{CE} = V_{GE}$, $I_C = 250\ \mu\text{A}$	3.75		5.75	V
$V_{CE(sat)}$	Collector-emitter saturation voltage	$V_{GE} = 15\text{V}$, $I_C = 5\text{A}$ $V_{GE} = 15\text{V}$, $I_C = 5\text{A}$, $T_C = 125^{\circ}\text{C}$		1.9 1.7	2.5	V V
g_{fs}	Forward transconductance	$V_{CE} = 15\text{V}$, $I_C = 5\text{A}$		3.5		S

Table 4. Dynamic

Symbol	Parameter	Test conditions	Min.	Typ.	Max.	Unit
C_{ies}	Input capacitance	$V_{CE} = 25\text{V}$, $f = 1\text{MHz}$, $V_{GE} = 0$		365		pF
C_{oes}	Output capacitance			43		pF
C_{res}	Reverse transfer capacitance			8.3		pF
Q_g	Total gate charge	$V_{CE} = 390\text{V}$, $I_C = 5\text{A}$,		19.2		nC
Q_{ge}	Gate-emitter charge	$V_{GE} = 15\text{V}$,		4.5		nC
Q_{gc}	Gate-collector charge	(see Figure 16)		7		nC

Table 5. Switching on/off (inductive load)

Symbol	Parameter	Test conditions	Min.	Typ.	Max.	Unit
$t_{d(on)}$ t_r $(di/dt)_{on}$	Turn-on delay time Current rise time Turn-on current slope	$V_{CC} = 390V, I_C = 5A$ $R_G = 10\Omega, V_{GE} = 15V,$ <i>Figure 15. Figure 17.</i>		14.2 5 1000		ns ns A/ μ s
$t_{d(on)}$ t_r $(di/dt)_{on}$	Turn-on delay time Current rise time Turn-on current slope	$V_{CC} = 390V, I_C = 5A$ $R_G = 10\Omega, V_{GE} = 15V,$ $T_j = 125^\circ C$ <i>Figure 15. Figure 17.</i>		14 5 920		ns ns A/ μ s
$t_r(V_{off})$ $t_{d(off)}$ t_f	Off voltage rise time Turn-off delay time Current fall time	$V_{CC} = 390V, I_C = 5A,$ $R_{GE} = 10\Omega, V_{GE} = 15V,$ <i>Figure 15. Figure 17.</i>		27 72 85		ns ns ns
$t_r(V_{off})$ $t_{d(off)}$ t_f	Off voltage rise time Turn-off delay time Current fall time	$V_{CC} = 390V, I_C = 5A,$ $R_{GE} = 10\Omega, V_{GE} = 15V,$ $T_j = 125^\circ C$ <i>Figure 15. Figure 17.</i>		50 108 139		ns ns ns

Table 6. Switching energy (inductive load)

Symbol	Parameter	Test conditions	Min.	Typ.	Max.	Unit
E_{on} $E_{off}^{(1)}$ E_{ts}	Turn-on switching losses Turn-off switching losses Total switching losses	$V_{CC} = 390V, I_C = 5A$ $R_G = 10\Omega, V_{GE} = 15V, T_j = 25^\circ C$ <i>(see Figure 17)</i>		31.8 95 126.8		μ J μ J μ J
E_{on} $E_{off}^{(1)}$ E_{ts}	Turn-on switching losses Turn-off switching Losses Total switching losses	$V_{CC} = 390V, I_C = 5A$ $R_G = 10\Omega, V_{GE} = 15V,$ $T_j = 125^\circ C$ <i>(see Figure 17)</i>		61.8 173 234.8		μ J μ J μ J

1. Turn-off losses include also the tail of the collector current

2.1 Electrical characteristics (curves)

Figure 1. Output characteristics

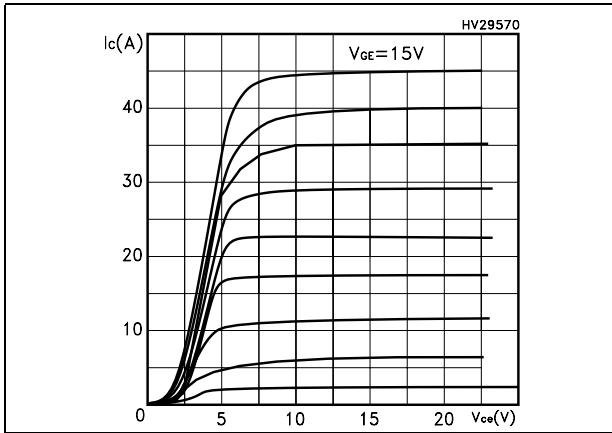

Figure 2. Transfer characteristics

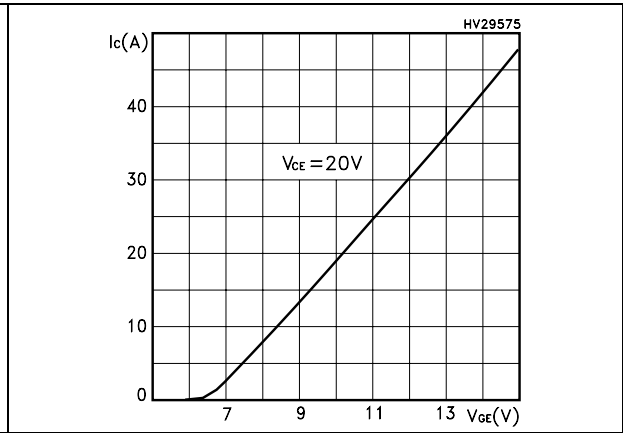

Figure 3. Transconductance

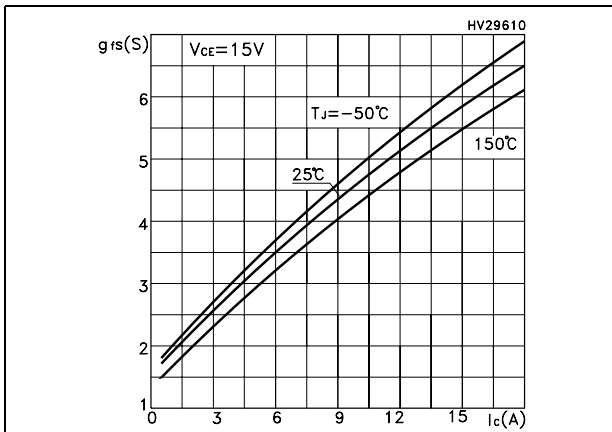

Figure 4. Collector-emitter on voltage vs temperature

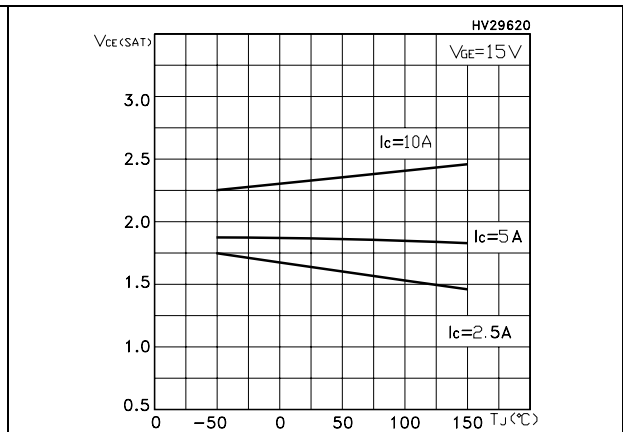

Figure 5. Gate charge vs gate-source voltage

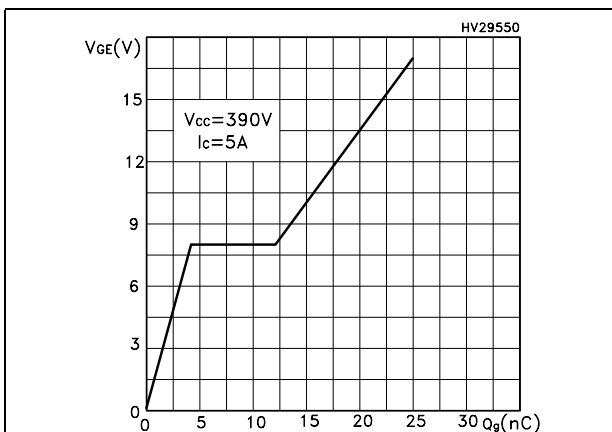

Figure 6. Capacitance variations

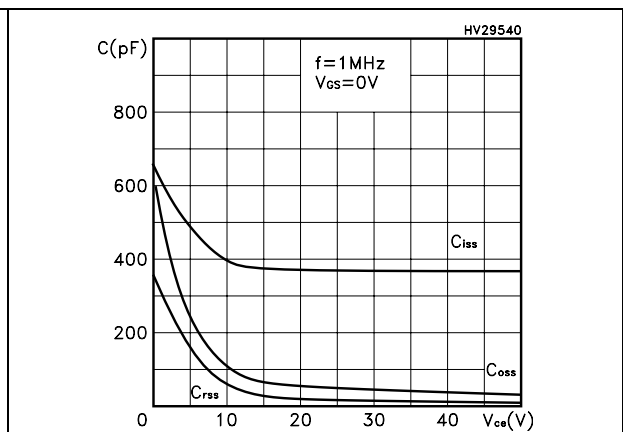

Figure 7. Normalized gate threshold voltage vs temperature

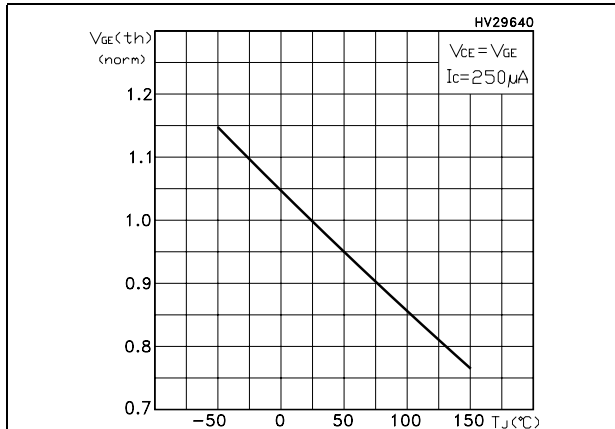

Figure 8. Collector-emitter on voltage vs collector current

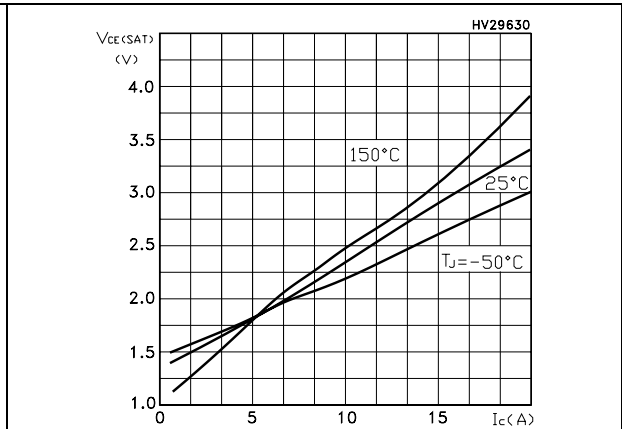

Figure 9. Normalized breakdown voltage vs temperature

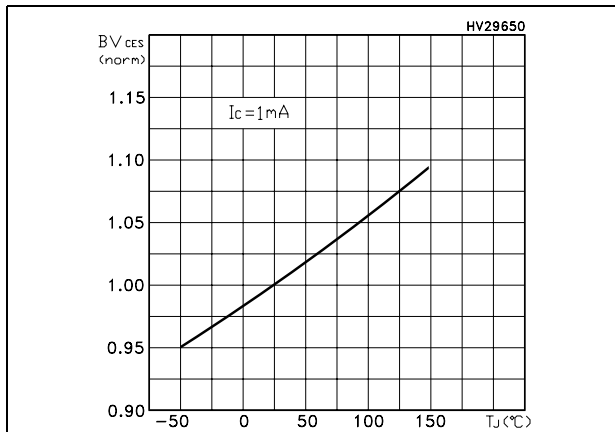

Figure 10. Switching losses vs temperature

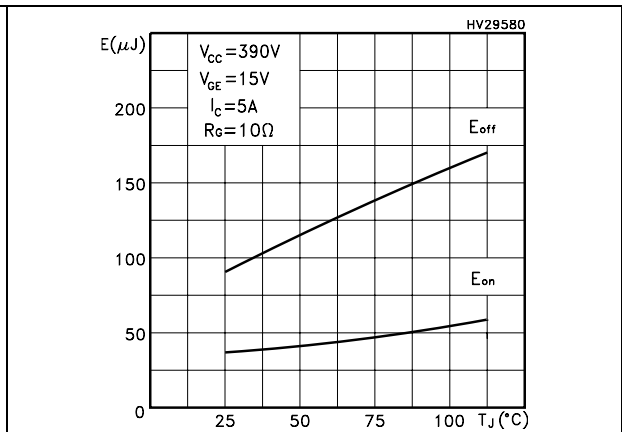

Figure 11. Switching losses vs gate resistance

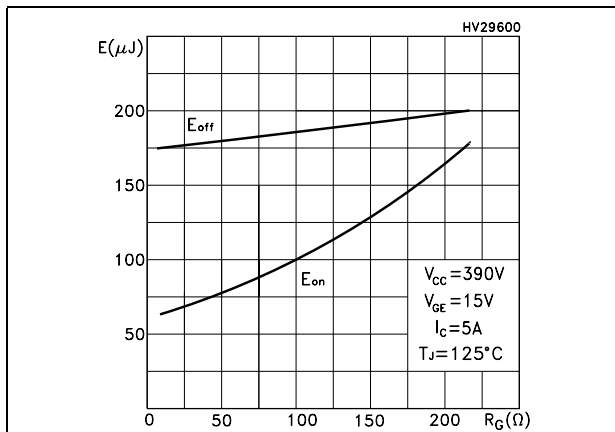

Figure 12. Switching losses vs collector current

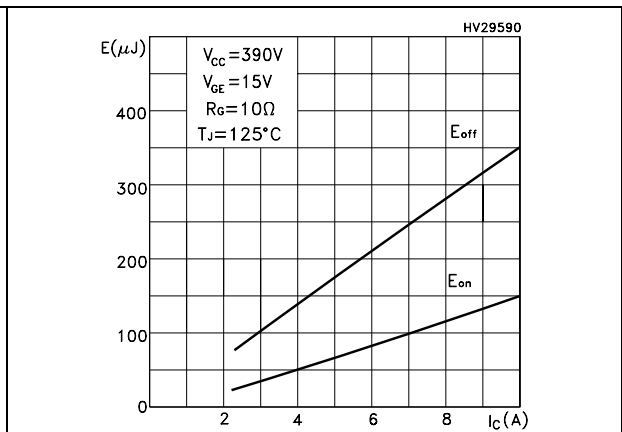

Figure 13. Thermal Impedance

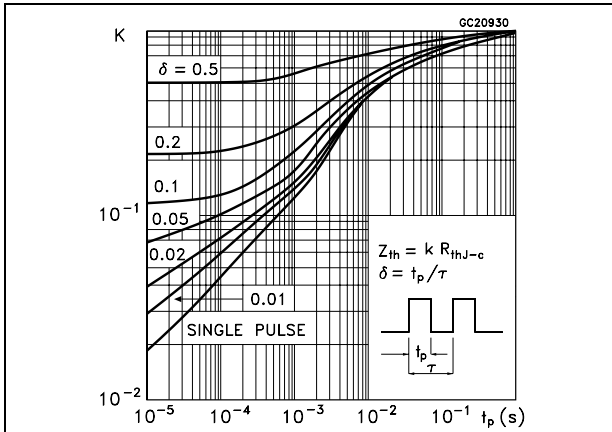
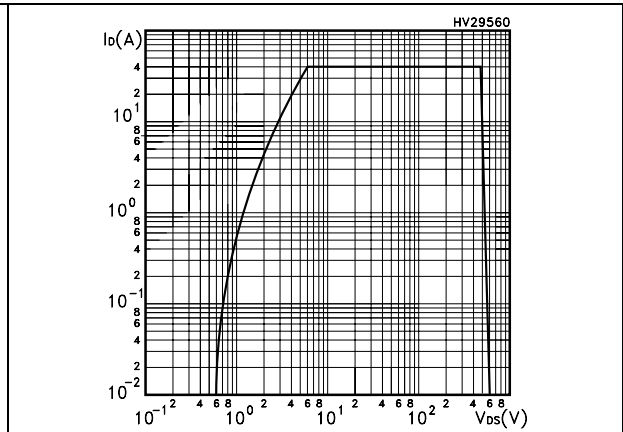

Figure 14. Turn-off SOA



3 Test circuits

Figure 15. Test circuit for inductive load switching

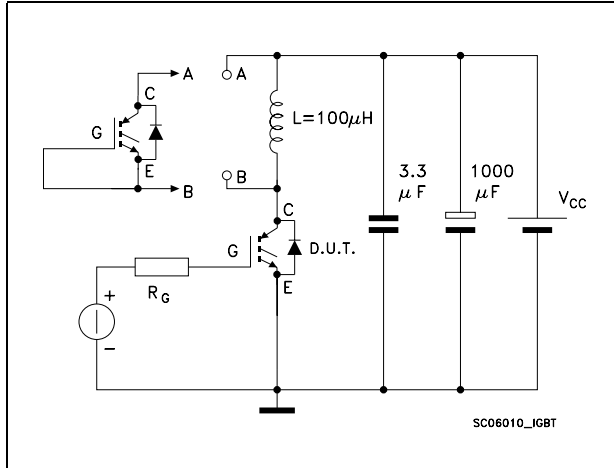

Figure 16. Gate charge test circuit

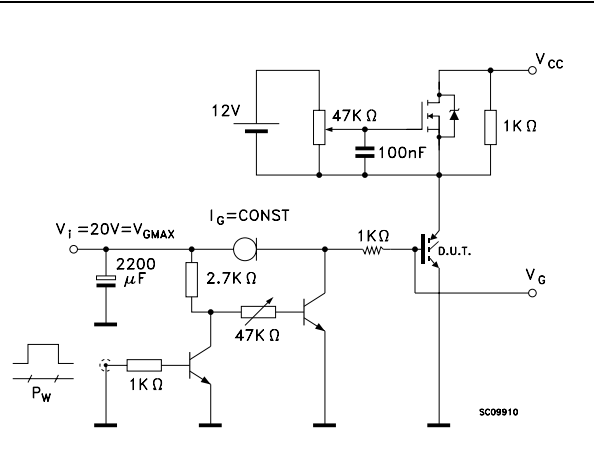
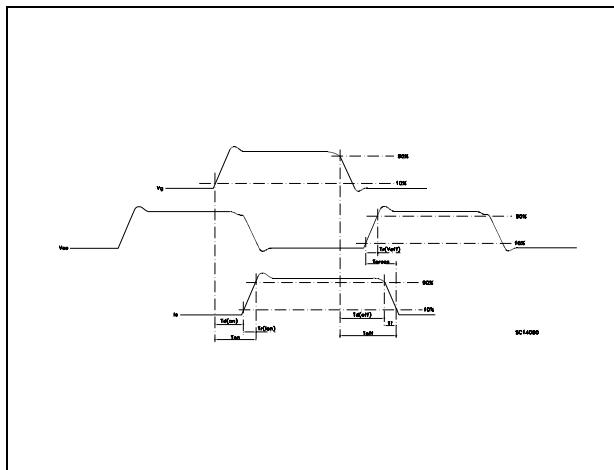

Figure 17. Switching waveform



4 Package mechanical data

In order to meet environmental requirements, ST offers these devices in ECOPACK® packages. These packages have a Lead-free second level interconnect. The category of second level interconnect is marked on the package and on the inner box label, in compliance with JEDEC Standard JESD97. The maximum ratings related to soldering conditions are also marked on the inner box label. ECOPACK is an ST trademark. ECOPACK specifications are available at: www.st.com

DPAK MECHANICAL DATA

DIM.	mm.			inch		
	MIN.	TYP	MAX.	MIN.	TYP.	MAX.
A	2.2		2.4	0.086		0.094
A1	0.9		1.1	0.035		0.043
A2	0.03		0.23	0.001		0.009
B	0.64		0.9	0.025		0.035
b4	5.2		5.4	0.204		0.212
C	0.45		0.6	0.017		0.023
C2	0.48		0.6	0.019		0.023
D	6		6.2	0.236		0.244
D1		5.1			0.200	
E	6.4		6.6	0.252		0.260
E1		4.7			0.185	
e		2.28			0.090	
e1	4.4		4.6	0.173		0.181
H	9.35		10.1	0.368		0.397
L	1			0.039		
(L1)		2.8			0.110	
L2		0.8			0.031	
L4	0.6		1	0.023		0.039
R		0.2			0.008	
V2	0°		8°	0°		8°

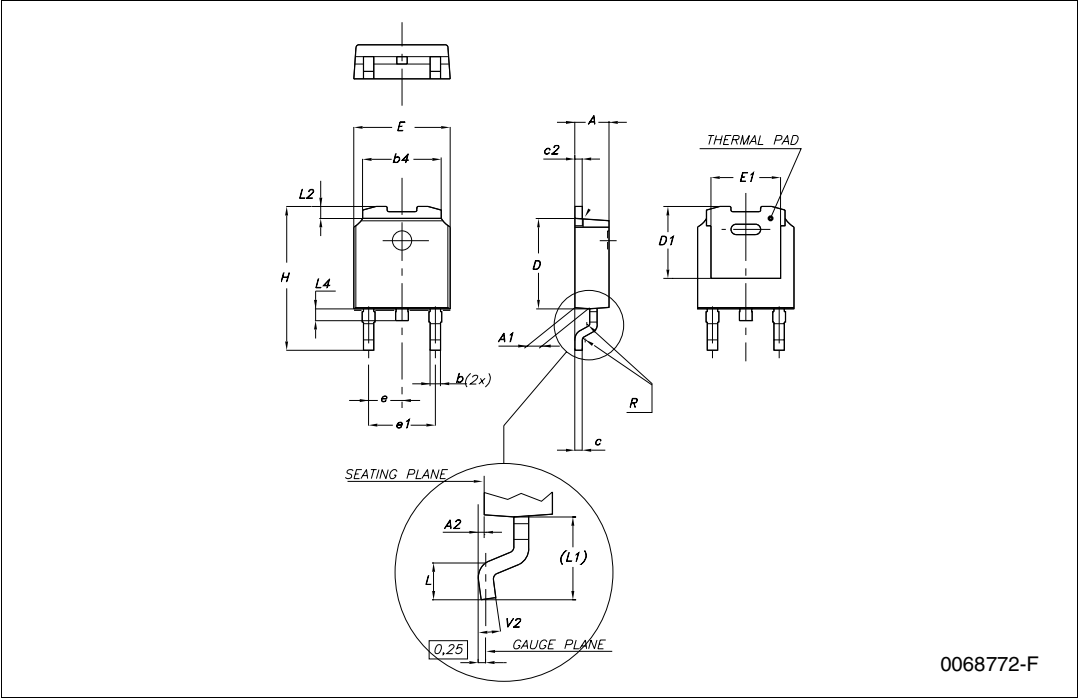

0068772-F

5 Packaging mechanical data

DPAK FOOTPRINT

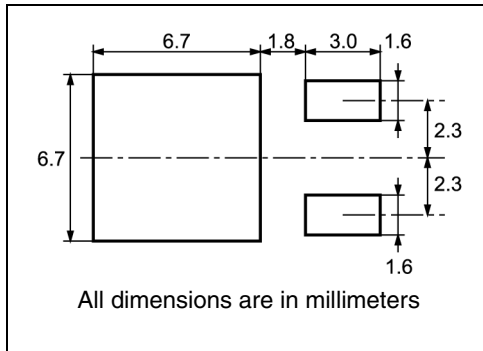

TAPE AND REEL SHIPMENT

40 mm min. Access hole at slot location

Full radius

Tape slot in core for tape start 2.5mm min. width

Labels: A, B, C, D, G, N, T

DIM.	mm		inch	
	MIN.	MAX.	MIN.	MAX.
A		330		12.992
B	1.5		0.059	
C	12.8	13.2	0.504	0.520
D	20.2		0.795	
G	16.4	18.4	0.645	0.724
N	50		1.968	
T		22.4		0.881

BASE QTY	BULK QTY
2500	2500

TAPE MECHANICAL DATA

DIM.	mm		inch	
	MIN.	MAX.	MIN.	MAX.
A0	6.8	7	0.267	0.275
B0	10.4	10.6	0.409	0.417
B1		12.1		0.476
D	1.5	1.6	0.059	0.063
D1	1.5		0.059	
E	1.65	1.85	0.065	0.073
F	7.4	7.6	0.291	0.299
K0	2.55	2.75	0.100	0.108
P0	3.9	4.1	0.153	0.161
P1	7.9	8.1	0.311	0.319
P2	1.9	2.1	0.075	0.082
R	40		1.574	
W	15.7	16.3	0.618	0.641

Labels: A0, B0, B1, D, D1, E, F, W, P0, P1, P2, T, K0

Labels: TOP COVER TAPE, User Direction of Feed, Center line of cavity, Bending radius R min., FEED DIRECTION

Note: For machine ref. only including draft and radii concentric around B0

Note: 10 pitches cumulative tolerance on tape +/- 0.2 mm

6 Revision history

Table 7. Revision history

Date	Revision	Changes
02-Apr-2007	1	Initial release.

Please Read Carefully:

Information in this document is provided solely in connection with ST products. STMicroelectronics NV and its subsidiaries ("ST") reserve the right to make changes, corrections, modifications or improvements, to this document, and the products and services described herein at any time, without notice.

All ST products are sold pursuant to ST's terms and conditions of sale.

Purchasers are solely responsible for the choice, selection and use of the ST products and services described herein, and ST assumes no liability whatsoever relating to the choice, selection or use of the ST products and services described herein.

No license, express or implied, by estoppel or otherwise, to any intellectual property rights is granted under this document. If any part of this document refers to any third party products or services it shall not be deemed a license grant by ST for the use of such third party products or services, or any intellectual property contained therein or considered as a warranty covering the use in any manner whatsoever of such third party products or services or any intellectual property contained therein.

UNLESS OTHERWISE SET FORTH IN ST'S TERMS AND CONDITIONS OF SALE ST DISCLAIMS ANY EXPRESS OR IMPLIED WARRANTY WITH RESPECT TO THE USE AND/OR SALE OF ST PRODUCTS INCLUDING WITHOUT LIMITATION IMPLIED WARRANTIES OF MERCHANTABILITY, FITNESS FOR A PARTICULAR PURPOSE (AND THEIR EQUIVALENTS UNDER THE LAWS OF ANY JURISDICTION), OR INFRINGEMENT OF ANY PATENT, COPYRIGHT OR OTHER INTELLECTUAL PROPERTY RIGHT.

UNLESS EXPRESSLY APPROVED IN WRITING BY AN AUTHORIZED ST REPRESENTATIVE, ST PRODUCTS ARE NOT RECOMMENDED, AUTHORIZED OR WARRANTED FOR USE IN MILITARY, AIR CRAFT, SPACE, LIFE SAVING, OR LIFE SUSTAINING APPLICATIONS, NOR IN PRODUCTS OR SYSTEMS WHERE FAILURE OR MALFUNCTION MAY RESULT IN PERSONAL INJURY, DEATH, OR SEVERE PROPERTY OR ENVIRONMENTAL DAMAGE. ST PRODUCTS WHICH ARE NOT SPECIFIED AS "AUTOMOTIVE GRADE" MAY ONLY BE USED IN AUTOMOTIVE APPLICATIONS AT USER'S OWN RISK.

Resale of ST products with provisions different from the statements and/or technical features set forth in this document shall immediately void any warranty granted by ST for the ST product or service described herein and shall not create or extend in any manner whatsoever, any liability of ST.

ST and the ST logo are trademarks or registered trademarks of ST in various countries.

Information in this document supersedes and replaces all information previously supplied.

The ST logo is a registered trademark of STMicroelectronics. All other names are the property of their respective owners.

© 2007 STMicroelectronics - All rights reserved

STMicroelectronics group of companies

Australia - Belgium - Brazil - Canada - China - Czech Republic - Finland - France - Germany - Hong Kong - India - Israel - Italy - Japan - Malaysia - Malta - Morocco - Singapore - Spain - Sweden - Switzerland - United Kingdom - United States of America

www.st.com

Данный компонент на территории Российской Федерации

Вы можете приобрести в компании MosChip.

Для оперативного оформления запроса Вам необходимо перейти по данной ссылке:

<http://moschip.ru/get-element>

Вы можете разместить у нас заказ для любого Вашего проекта, будь то серийное производство или разработка единичного прибора.

В нашем ассортименте представлены ведущие мировые производители активных и пассивных электронных компонентов.

Нашей специализацией является поставка электронной компонентной базы двойного назначения, продукции таких производителей как XILINX, Intel (ex.ALTERA), Vicor, Microchip, Texas Instruments, Analog Devices, Mini-Circuits, Amphenol, Glenair.

Сотрудничество с глобальными дистрибьюторами электронных компонентов, предоставляет возможность заказывать и получать с международных складов практически любой перечень компонентов в оптимальные для Вас сроки.

На всех этапах разработки и производства наши партнеры могут получить квалифицированную поддержку опытных инженеров.

Система менеджмента качества компании отвечает требованиям в соответствии с ГОСТ Р ИСО 9001, ГОСТ РВ 0015-002 и ЭС РД 009

Офис по работе с юридическими лицами:

105318, г.Москва, ул.Щербаковская д.3, офис 1107, 1118, ДЦ «Щербаковский»

Телефон: +7 495 668-12-70 (многоканальный)

Факс: +7 495 668-12-70 (доб.304)

E-mail: info@moschip.ru

Skype отдела продаж:

moschip.ru

moschip.ru_4

moschip.ru_6

moschip.ru_9