

# MLX90641 16x12 IR array

## Datasheet

### 1. Features and Benefits

- Small size, low cost 16x12 pixels IR array
- Easy to integrate
- Industry standard four lead TO39 package
- Factory calibrated
- Noise Equivalent Temperature Difference (NETD) 0.1K @4Hz refresh rate
- I<sup>2</sup>C compatible digital interface
- Programmable refresh rate 0.5Hz...64Hz
- 3.3V supply voltage
- Current consumption ≈ 12mA
- 2 FOV options – 55°x35° and 110°x75°
- Operating temperature -40°C ÷ 125°C
- Target temperature -40°C ÷ 300°C
- Complies with RoHS regulations



### 2. Application Examples

- High precision non-contact temperature measurements
- Microwave ovens
- Intrusion / Movement detection
- Temperature sensing element for residential, commercial and industrial building air conditioning
- Thermal Comfort sensor in automotive Air Conditioning control system
- Passenger classification
- Industrial temperature control of moving parts
- Visual IR thermometers
- Driver SW for MCU available at: <https://github.com/melexis/mlx90641-library.git>

### 3. Description

The MLX90641 is a fully calibrated 16x12 pixels thermal IR array in an industry standard 4-lead TO39 package with digital interface.

The MLX90641 contains 192 FIR pixels. An ambient sensor is integrated to measure the ambient temperature of the chip and supply sensor to measure the VDD. The outputs of all sensors IR, Ta and VDD are stored in internal RAM and are accessible through I<sup>2</sup>C.



Figure 1 Block diagram

# Contents

1. Features and Benefits.....	1
2. Application Examples.....	1
3. Description .....	1
4. Ordering Information .....	6
5. Glossary of Terms.....	7
6. Pin Definitions and Descriptions .....	8
7. Absolute Maximum Ratings .....	8
8. General Electrical Specifications .....	9
9. False pixel correction.....	10
10. Detailed General Description.....	10
10.1. Pixel position .....	10
10.2. Communication protocol .....	11
10.2.1. Low level .....	11
10.3. Measurement mode .....	12
10.4. Refresh rate.....	12
10.5. Measurement flow .....	13
10.6. Address map .....	15
10.6.1. Internal registers.....	15
10.6.2. RAM .....	17
EEPROM.....	18
11. Calculating Object Temperature .....	21
11.1. Restoring calibration data from EERPOM and calculations.....	21
11.1.1. Restoring the VDD sensor parameters and VDD calculations .....	21
11.1.2. Restoring the Ta sensor parameters .....	22
11.1.3. Restoring the offset .....	22
11.1.4. Restoring the Sensitivity $\alpha_{i,j}$ .....	23
11.1.5. Restoring the Kta(i,j) coefficient .....	24
11.1.6. Restoring the Kv(i,j) coefficient.....	24
11.1.7. Restoring the GAIN coefficient (common for all pixel).....	25
11.1.8. Restoring the KsTa coefficient (common for all pixel).....	25
11.1.9. Restoring corner temperatures (common for all pixel).....	25

11.1.10. Restoring the KsTo coefficient (common for all pixel)	25
11.1.11. Restoring sensitivity correction coefficients for each temperature range	26
11.1.12. Restoring Emissivity	26
11.1.13. Restoring the Sensitivity $\alpha$ CP	27
11.1.14. Restoring the offset of the CP	27
11.1.15. Restoring the Kv CP coefficient	27
11.1.16. Restoring the Kta CP coefficient	27
11.1.17. Restoring the TGC coefficient	27
11.1.18. Restoring calibration resolution control settings	28
11.2. Temperature calculation	28
11.2.1. Example input data	28
11.2.2. Temperature calculation	31
<b>12. Performance graphs</b>	<b>42</b>
12.1. Accuracy	42
12.1.1. Pixel accuracy	42
12.1.2. Ta accuracy	43
12.2. Startup time	44
12.2.1. First valid data	44
12.2.2. Thermal behavior	44
12.3. Noise performance and resolution	45
12.4. Field of view (FOV)	47
<b>13. Application information</b>	<b>48</b>
13.1. Optical considerations	48
13.2. Electrical considerations	48
13.3. Using the device in “image mode”	49
<b>14. Application Comments</b>	<b>50</b>
<b>15. Mechanical drawings</b>	<b>51</b>
15.1. FOV 55°	51
15.2. FOV 110°	52
15.3. Device marking	53
<b>16. Standard Information</b>	<b>54</b>
<b>17. ESD Precautions</b>	<b>54</b>
<b>18. Revision History Table</b>	<b>54</b>

19. Contact.....	55
20. Disclaimer.....	55

## Tables

Table 1 Ordering information.....	6
Table 2 Glossary of terms.....	7
Table 3 Pin definition.....	8
Table 4 Absolute maximum ratings .....	8
Table 5 Electrical specification .....	9
Table 6 Priorities of subpage controls .....	16
Table 7 Configuration parameters memory .....	18
Table 8 EEPROM overview (words).....	19
Table 9 Calibration parameters memory (EEPROM - bits) .....	20
Table 10 Calculation example input data .....	28
Table 11 Calculation example calibration data .....	30
Table 12 Noise performance .....	46
Table 13 Available FOV options.....	47
Table 14 Revision history .....	54

## Figures

Figure 1 Block diagram.....	1
Figure 2 MLX90641 Overview and pin description .....	8
Figure 3 Pixel in the whole FOV.....	10
Figure 4 I <sup>2</sup> C write command format (default SA=0x33 is used) .....	11
Figure 5 I <sup>2</sup> C read command format (default SA=0x33 is used) .....	11
Figure 6 Refresh rate timing.....	12
Figure 7 Recommended measurement flow .....	13
Figure 8 TV mode reading pattern.....	14
Figure 9 MLX90641 memory map.....	15
Figure 10 Status register (0x8000) bits meaning .....	15
Figure 11 Control register 1 (0x800D) bits meaning .....	16
Figure 12 I <sup>2</sup> C configuration register (0x800F) bits meaning .....	17
Figure 13 RAM memory map (Interleaved mode - default).....	17
Figure 14 EEPROM to registers mapping.....	18
Figure 15 EEPROM Hamming and data bit meaning .....	21
Figure 16 To calculation flow .....	31
Figure 17 Temperature absolute accuracy - MLX90641BCA.....	42
Figure 18 Temperature absolute accuracy - MLX90641BCB.....	43
Figure 19 Different accuracy zones depending on device type (BCA on the left and BCB on the right).....	43
Figure 20 MLX90641BCx noise vs refresh rate for different device types .....	45
Figure 21 MLX90641BCA noise vs pixel and refresh rate at 1Hz and 2Hz .....	45
Figure 22 MLX90641BCA noise vs pixel and refresh rate at 4Hz, 8Hz and 16Hz .....	45

Figure 23 MLX90641BCB noise vs pixel and refresh rate at 1Hz and 2Hz.....	46
Figure 24 MLX90641BCB noise vs pixel and refresh rate at 4Hz, 8Hz and 16Hz .....	46
Figure 25 Field Of View measurement.....	47
Figure 26 Application examples concerning the optical consideration .....	48
Figure 27 MLX90641Bxx electrical connections.....	48
Figure 28 Calculation flow in thermal image mode .....	49
Figure 29 Mechanical drawing of 55° FOV device.....	51
Figure 30 Mechanical drawing of 110° FOV device.....	52

## 4. Ordering Information

Product	Temperature	Package	Option Code	Custom Configuration	Packing Form	Definition
MLX90641	E	SF	BCA	000	TU	16x12 IR array
MLX90641	E	SF	BCB	000	TU	16x12 IR array
MLX90641	K	SF	BCA	000	TU	16x12 IR array
MLX90641	K	SF	BCB	000	TU	16x12 IR array

### Legend:

Temperature Code:	E: -40°C to 85°C K: -40°C to 125°C
Package Code:	“SF” for TO39 package
Option Code:	xAx – TGC is disabled and may not be enabled xCx – TGC is enabled
Option Code:	xxA – FOV = 110°x75° xxB – FOV = 55°x35°
Custom configuration	000 – standard product
Packing Form:	“TU” - Tubes
Ordering Example:	“MLX90641KSF-BCA-000-TU”

*Table 1 Ordering information*

## 5. Glossary of Terms

TC	Temperature Coefficient (in ppm/°C)
POR	Power On Reset
IR	Infra-Red
Ta	Ambient Temperature – the temperature of the TO39 package
IR data	Infrared data (raw data from ADC proportional to IR energy received by the sensor)
ADC	Analog To Digital Converter
TGC	Temperature Gradient Coefficient
FOV	Field Of View
nFOV	Field Of View of the N-th pixel
I <sup>2</sup> C	Inter-Integrated Circuit communication protocol
SDA	Serial Data
SCL	Serial Clock
LSB	Least Significant Bit
MSB	Most Significant Bit
Fps	Frames per Second – data refresh rate
MD	Master Device
SD	Slave Device
ASP	Analogue Signal Processing
DSP	Digital Signal Processing
ESD	Electro Static Discharge
EMC	Electro Magnetic Compatibility
NC	Not Connected
NA	Not Applicable

*Table 2 Glossary of terms*

## 6. Pin Definitions and Descriptions

Pin #	Name	Description
1	SDA	I <sup>2</sup> C serial data (input / output)
2	VDD	Positive supply
3	GND	Negative supply (Ground)
4	SCL	I <sup>2</sup> C serial clock (input only)

Table 3 Pin definition



Figure 2 MLX90641 Overview and pin description

## 7. Absolute Maximum Ratings

Parameter	Symbol	Min.	Typ.	Max.	Unit	Remark
Supply Voltage (over voltage)	V <sub>DD</sub>			5	V	
Supply Voltage (operating max voltage)	V <sub>DD</sub>			3.6		
Reverse Voltage (each pin)				-0.3	V	
Operating Temperature	T <sub>AMB</sub>	-40		+125	°C	
Storage Temperature	T <sub>ST</sub>	-40		+150	°C	Not in plastic tubes
ESD sensitivity (AEC Q100 002)		4			kV	
SDA DC sink current				40	mA	

Table 4 Absolute maximum ratings

Exceeding the absolute maximum ratings may cause permanent damage. Exposure to absolute maximum-rated conditions for extended periods may affect device reliability.



## 8. General Electrical Specifications

Electrical Parameter	Symbol	Min.	Typ.	Max.	Unit	Condition
Supply Voltage	$V_{DD}$	3	3.3	3.6	V	
Supply Current	$I_{DD}$	10	12	14	mA	
POR level up analog	$V_{POR\_UP}$	2.2		2.6	V	VDD rising
POR level down analog	$V_{POR\_DOWN}$			2.55	V	VDD falling
POR hysteresis	$V_{POR\_hys}$		50		mV	
I <sup>2</sup> C address <sup>(NOTE 3)</sup>		0x01	0x33 (default)	0x7F		
Input high voltage (SDA, SCL)	$V_{IH}$	$0.7 \cdot V_{DD}$			V	Over Ta and $V_{DD}$
Input low voltage (SDA, SCL)	$V_{LOW}$			$0.3 \cdot V_{DD}$	V	Over Ta and $V_{DD}$
SDA output low voltage	$V_{OL}$			0.4	V	Over Ta and $V_{DD}$ $I_{SINK}=3mA$
SDA leakage	$I_{SDA\_leak}$			$\pm 10$	$\mu A$	$V_{SDA}=3.6V, Ta=150^{\circ}C$
SCL leakage	$I_{SCL\_leak}$			$\pm 10$	$\mu A$	$V_{SCL}=3.6V, Ta=150^{\circ}C$
SDA capacitance	$C_{SDA}$			10	pF	
SCL capacitance	$C_{SCL}$			10	pF	
Acknowledge setup time	$T_{SUAC(MD)}$			0.45	$\mu s$	
Acknowledge hold time	$T_{DUAC(MD)}$			0.45	$\mu s$	
Acknowledge setup time	$T_{SUAC(SD)}$			0.45	$\mu s$	
Acknowledge hold time	$T_{DUAC(SD)}$			0.45	$\mu s$	
I <sup>2</sup> C clock frequency	$F_{I2C}$		0.4	1	MHz	
Erase/write cycles				10	times	Ta = 25°C
Write cell time	$T_{WRITE}$	5			ms	

Table 5 Electrical specification

**NOTE 1:** For best performance it is recommended to keep the supply voltage as accurate and stable as possible to  $3.3V \pm 0.05V$

**NOTE 2:** When a data in EEPROM cell to be changed an erase (write 0x0000) must be done prior to writing the new value. After each write at least 5ms delay is needed in order to writing process to take place.

**NOTE 3:** Slave address 0x00 must be avoided.

**NOTE 4:** According to I<sup>2</sup>C standard the max sink current is specified to be 20mA, however due to the thermal considerations (the dissipated power into the driver) the max current is limited to 10mA. This is the only parameter which does not comply with the FM+ specification.

**NOTE 5:** Max EEPROM I<sup>2</sup>C speed operations to be done at 400kHz.

## 9. False pixel correction

The imager can have up to 1 defective pixel, with either no output or out of specification temperature reading. These pixels are identified in the EEPROM table of the sensor and can be read out through the I<sup>2</sup>C. The defective pixel result can be replaced by an interpolation of its neighboring pixels.

## 10. Detailed General Description

### 10.1. Pixel position

The array consists of 192 IR sensors (also called pixels). Each pixel is identified with its row and column position as Pix(*i,j*) where *i* is its row number (from 1 to 12) and *j* is its column number (from 1 to 16)



Figure 3 Pixel in the whole FOV

## 10.2. Communication protocol

The device use I<sup>2</sup>C protocol with support of FM+ mode (up to 1MHz clock frequency) and can be only slave on the bus. The SDA and SCL ports are 5V tolerant and the sensor can be directly connected to a 5V I<sup>2</sup>C network. The slave address is programmable and can have up to 127 different slave addresses (SA = 0x00 **must** be avoided).

### 10.2.1. Low level

#### 10.2.1.1. Start / Stop conditions

Each communication session is initiated by a START condition and ends with a STOP condition. A START condition is initiated by a HIGH to LOW transition of the SDA while a STOP is generated by a LOW to HIGH transition. Both changes must be done while the SCL is HIGH.

#### 10.2.1.2. Device addressing

The master is addressing the slave device by sending a 7-bit slave address after the START condition. The first seven bits are dedicated for the address and the 8<sup>th</sup> is Read/Write (R/W) bit. This bit indicates the direction of the transfer:

- Read (HIGH) means that the master will read the data from the slave
- Write (LOW) means that the master will send data to the slave

#### 10.2.1.3. Acknowledge

During the 9<sup>th</sup> clock following every byte transfer the transmitter releases the SDA line. The receiver acknowledges (ACK) receiving the byte by pulling SDA line to low or does not acknowledge (NoACK) by letting the SDA 'HIGH'.

#### 10.2.1.4. I<sup>2</sup>C command format



Figure 4 I<sup>2</sup>C write command format (default SA=0x33 is used)

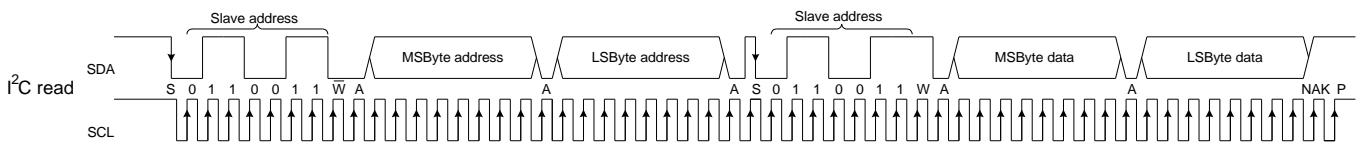

Figure 5 I<sup>2</sup>C read command format (default SA=0x33 is used)

### 10.3. Measurement mode

In this mode the measurements are constantly running. Depending on the selected frame rate  $F_{ps}$  in the control register, the data for IR pixels and  $T_a$  will be updated in the RAM each  $\frac{1}{F_{ps}}$  seconds. In this mode the external microcontroller has full access to the internal registers and memories of the device.

### 10.4. Refresh rate

The refresh rate is configured by “Control register 1” (0x800D) i.e. if “Refresh rate control” = 011 → 4Hz this would mean that each 250ms a new data (full frame) is available in the RAM.

NOTE: It is possible to program the desired refresh rate into device EEPROM eliminating the necessity to reconfigure the device every time it is powered on. The corresponding EEPROM cell is at address 0x240C (see Table 7)

Which subpage is updated is indicated by the “Last measured subpage” field.

It is important both subpages to be read as the necessary information for the  $T_a$  calculations is only available by combining the data from both subpages i.e. the  $T_a$  is refreshed with refresh rate twice as low as the one set in “Refresh rate control”.

When a new data (subpage) is available a dedicated bit is set to indicate this – bit 3 “New data available in RAM” in “Status register” (0x8000). It is up to the customer to reset the bit once the data is dumped.

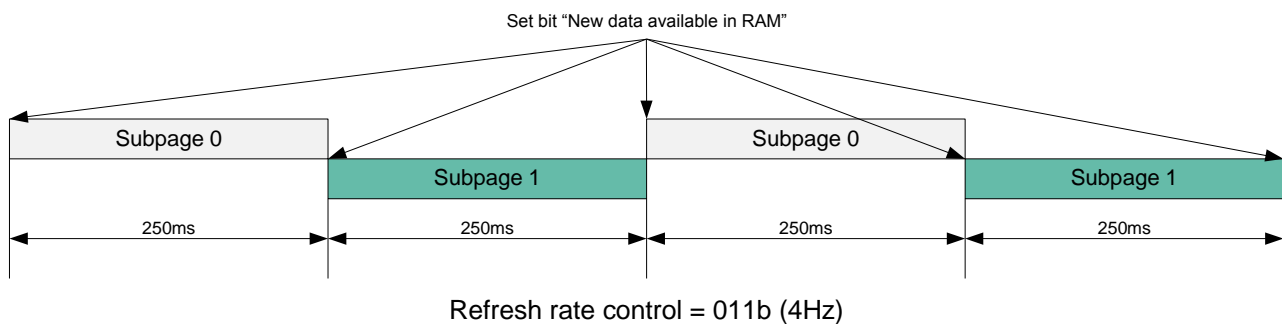

Figure 6 Refresh rate timing

## 10.5. Measurement flow

Following measurement flow is recommended:

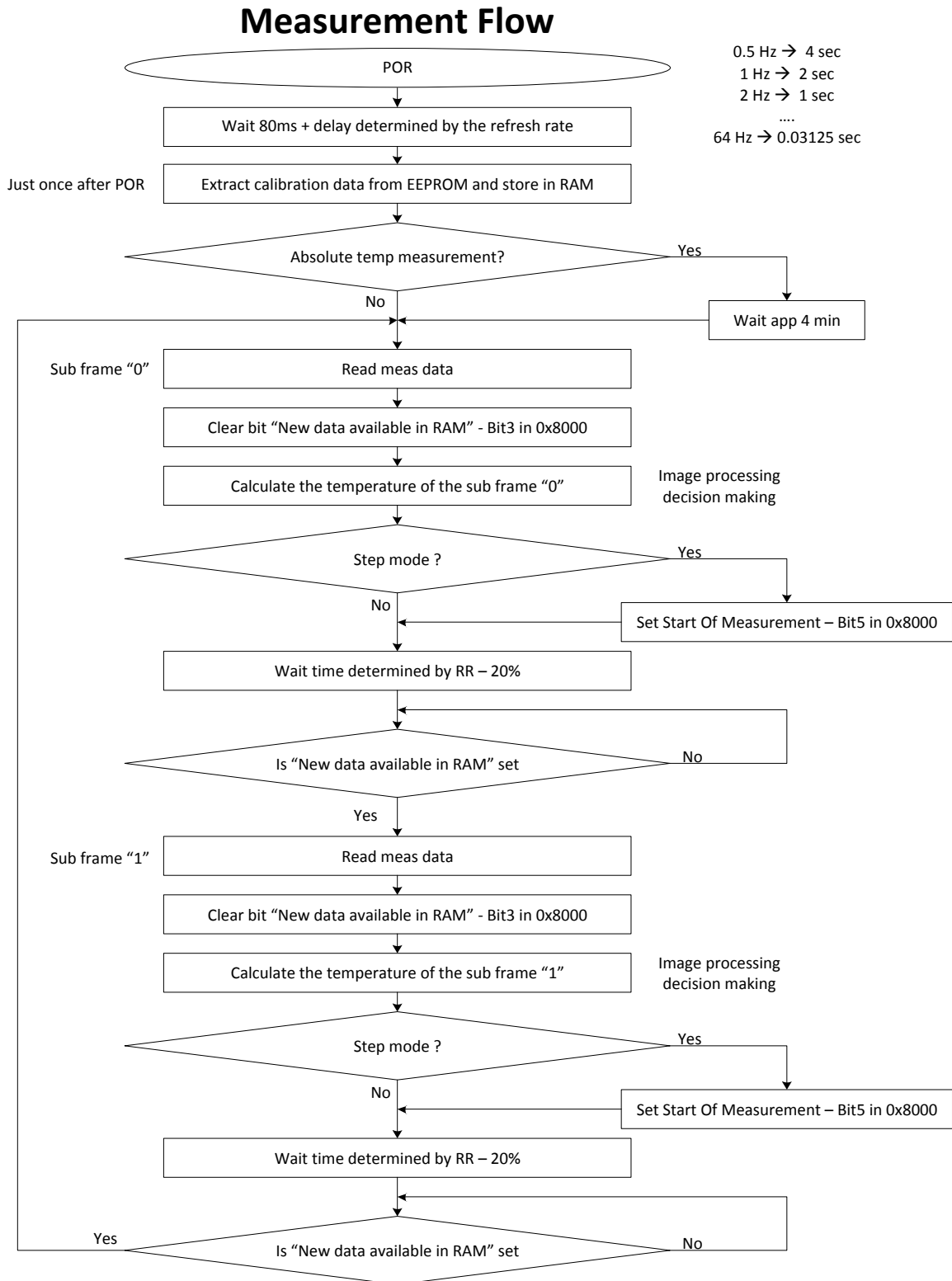

Figure 7 Recommended measurement flow

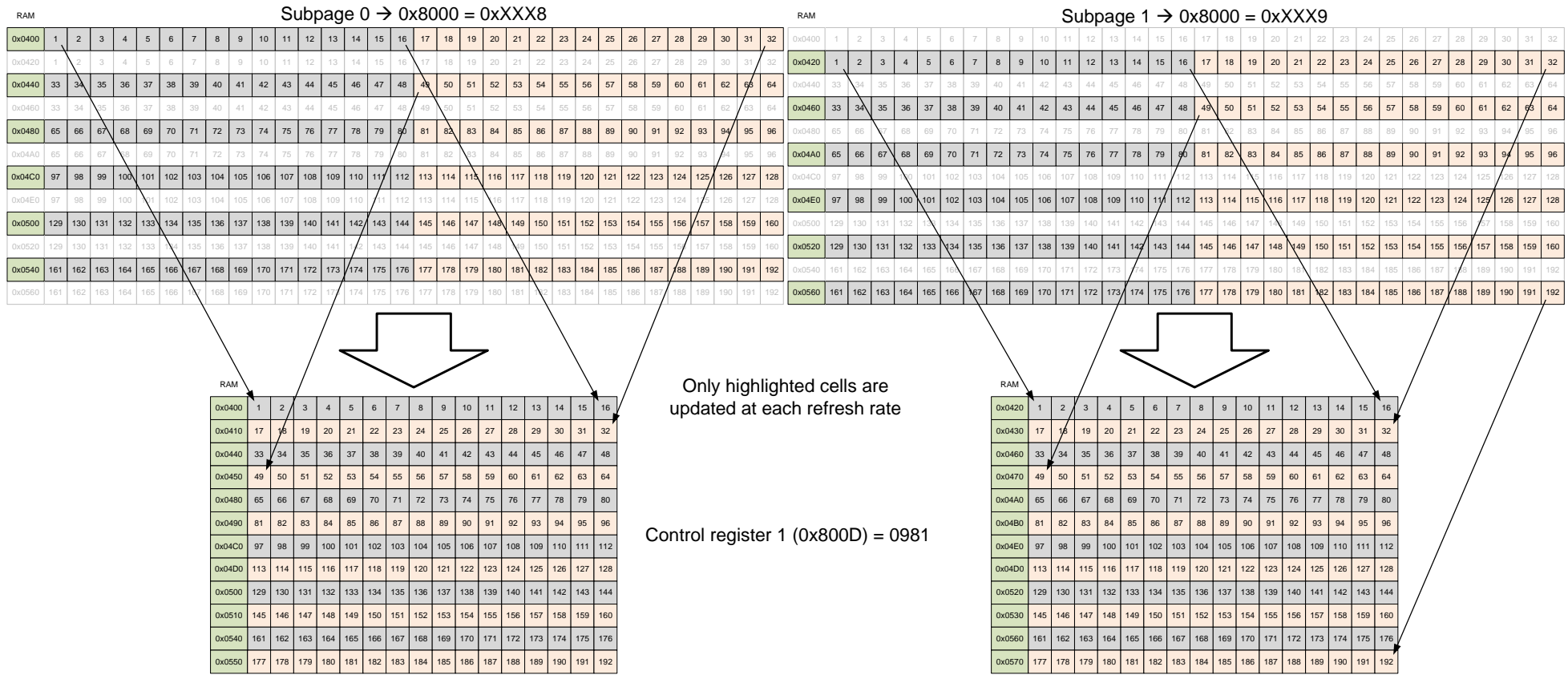

Figure 8 TV mode reading pattern

## 10.6. Address map

0x0000	ROM
0x03FF	
0x0400	RAM
0x05BF	
0x2400	EEPROM
0x273F	
0x8000	Registers (MLX reserved)
0x800C	
0x800D	Registers
0x8011	
0x8011	Registers (MLX reserved)
0x8016	

Figure 9 MLX90641 memory map

### 10.6.1. Internal registers

There are few internal register that are customer accessible through which the device performance may be customized:

B15	B14	B13	B12	B11	B10	B9	B8	B7	B6	B5	B4	B3	B2	B1	B0			
Melexis reserved											Enable overwrite	New data available in RAM	Last measured subpage controlled by MLX90641			Status register - 0x8000		
													0	0	0		Measurement of subpage 0 has been measured	
													0	0	1		Measurement of subpage 1 has been measured	
													0	1	0		Melexis reserved	
													0	1	1		Melexis reserved	
													1	0	0		Melexis reserved	
													1	0	1		Melexis reserved	
													1	1	0		Melexis reserved	
													1	1	1		Melexis reserved	
													0	No new data is available in RAM (must be reset by the customer)				
													1	A new data is available in RAM				
													0	Data in RAM overwrite is disabled				
													1	Data in RAM overwrite is enabled				
											Melexis reserved							

Figure 10 Status register (0x8000) bits meaning

B15	B14	B13	B12	B11	B10	B9	B8	B7	B6	B5	B4	B3	B2	B1	B0	
Melexis reserved			Reading pattern	Resolution control		Refresh rate control			Select subpage			Enable subpages repeat	Enable data hold	Melexis reserved	Enable subpages mode	<b>Control register 1 - 0x800D</b>
															0 No subpages, only one page will be measured	
															1 Subpage mode is activated (default)	
															0 Keep this bit = "0" (default)	
															0 Transfer the data into storage RAM at each measured frame (default)	
															1 Transfer the data into storage RAM only if en_overwrite = 1 (check 0x8000)	
															0 Toggles between subpage "0" and subpage "1" if Enable subpages mode = "1" (default)	
															1 Select subpage determines which subpage to be measured if Enable subpages mode = "1"	
									0 0 0 Subpage 0 is selected (default)							
									0 0 1 Subpage 1 is selected							
									0 1 0 Not Applicable							
									0 1 1 Not Applicable							
									1 0 0 Not Applicable							
									1 0 1 Not Applicable							
									1 1 0 Not Applicable							
									1 1 1 Not Applicable							
						0 0 0 IR refresh rate = 0.5Hz										
						0 0 1 IR refresh rate = 1Hz										
						0 1 0 IR refresh rate = 2Hz (default)										
						0 1 1 IR refresh rate = 4Hz										
						1 0 0 IR refresh rate = 8Hz										
						1 0 1 IR refresh rate = 16Hz										
						1 1 0 IR refresh rate = 32Hz										
						1 1 1 IR refresh rate = 64Hz										
						0 0 ADC set to 16 bit resolution										
						0 1 ADC set to 17 bit resolution										
						1 0 ADC set to 18 bit resolution (default)										
						1 1 ADC set to 19 bit resolution										
						0 Interleaved (TV) mode (default)										
						1 Chess pattern										
-			Melexis reserved													

Figure 11 Control register 1 (0x800D) bits meaning

Enable subpage mode (Bit 0)	Enable subpage repeat (Bit 3)	Select subpage (Bit 4)	Working mode
0	0	-	measure subpage 0 only
0	1	-	measure subpage 0 only
1	0	-	0 → 1 → 0 → 1 ...
1	1	0	measure subpage 0 only
1	1	1	measure subpage 1 only

Table 6 Priorities of subpage controls



B7	B6	B5	B4	B3	B2	B1	B0	B7	B6	B5	B4	B3	B2	B1	B0										
Melexis reserved												Melexis reserved	SDA driver current limit control	I2C threshold levels	FM+ disable	I2C configuration register - 0x800F									
													0	FM+ mode enabled (default)											
													1	FM+ mode disabled											
													0	VDD referred threshold (normal mode) (default)											
													1	1.8V referred threshold (1.8V mode)											
													0	SDA driver current limit is ON (default)											
													1	SDA driver current limit is OFF											
													0	Melexis reserved											
												Melexis reserved													

Figure 12 I<sup>2</sup>C configuration register (0x800F) bits meaning

### 10.6.2. RAM

0x0400	Pixels 1...16 (subpage 0)	Pixels 17...32 (subpage 0)	0x041F
0x0420	Pixels 1...16 (subpage 1)	Pixels 17...32 (subpage 1)	0x043F
0x0440	Pixels 33...48 (subpage 0)	Pixels 49...64 (subpage 0)	0x045F
0x0460	Pixels 33...48 (subpage 1)	Pixels 49...64 (subpage 1)	0x047F
0x0480	...	...	0x049F
...			...
0x0520			0x053F
0x0540	Pixels 161...176 (subpage 0)	Pixels 177...192 (subpage 0)	0x055F
0x0560	Pixels 161...176 (subpage 1)	Pixels 177...192 (subpage 1)	0x057F
0x0580	0x0580=Ta_Vbe, 0x0588=CP(SP 0), 0x058A=GAIN	Melexis reserved	0x059F
0x05A0	0x05A0=Ta_PTAT, 0x05A8=CP(SP1), 0x05AA=VDDpix	Melexis reserved	0x05BF

Figure 13 RAM memory map (Interleaved mode - default)

## EEPROM

The EEPROM is used to store the calibration constants and the configuration parameters of the device

EEPROM address	Access	Meaning
0x2400	Melexis	Melexis reserved
0x2401	Melexis	Melexis reserved
0x2402	Melexis	Melexis reserved
0x2403	Melexis	Configuration register
0x2404	Melexis	Melexis reserved
0x2405	Melexis	Melexis reserved
0x2406	Melexis	Melexis reserved
0x2407	Melexis	Device ID1
0x2408	Melexis	Device ID2
0x2409	Melexis	Device ID3
0x240A	Melexis	Device Options
0x240B	Melexis	Melexis reserved
0x240C	Customer	Control register_1
0x240D	Customer	Control register_2
0x240E	Customer	I2CConfReg
0x240F	Customer	Melexis reserved / I2C_Address

*Table 7 Configuration parameters memory*

After POR the device read dedicated EEPROM cells and transfers their content to into the control and configuration register of the device. This way the device is configured and prepared for operation. The relation between EEPROM and register address is shown here after (explanation of the bit meaning can be found in section 10.6.1 Internal registers):

EEPROM address	Register address	Access	Name	Data [hex]
0x240C	0x800D	Customer	Control_register_1	0901
0x240D	0x800E	Customer	Control_register_2	0000
0x240E	0x800F	Customer	I2CConfReg	0000
0x240F	0x8010	Customer	Melexis internal use (8 bit) I2C_Address (8bit)	BE33

*Figure 14 EEPROM to registers mapping*

Address	0	1	2	3	4	5	6	7	8	9	A	B	C	D	E	F
0x2400	Osc Trim	Ana Trim 1	MLX	Conf reg	Ana Trim 2	MLX	MLX	ID 1	ID 2	ID 3	MLX	MLX	Cont reg 1	Cont reg 2	I2C conf	I2C add
0x2410	Scale occ	Pix os R1		MLX		Kta_avg	Kta scales	Kv_avg	Kv scales	Scale_row 1..6			row1_max	row2_max	row3_max	row4_max
0x2420	row5_max	row6_max	KsTa	Emissivity	Gain		Vdd_25	K_vdd	PTAT_25		Kt_PTAT	Kv_PTAT	Alpha PTAT	Alpha CP	CP scale	OS 1 CP
0x2430	OS 2 CP	Kt CP	Kv CP	TGC	KsTo scale	KsTo_1	KsTo_2	KsTo_3	KsTo_4	KsTo_5	CT6	KsTo_6	CT7	KsTo_7	CT8	KsTo_8
0x2440	192 x Pixel offset - subpage 1															
0x2450																
0x2460																
0x2470																
0x2480																
0x2490																
0x24A0																
0x24B0																
0x24C0																
0x24D0																
0x24E0																
0x24F0																
0x2500	192 x Pixel sensitivity - $\alpha$															
0x2510																
0x2520																
0x2530																
0x2540																
0x2550																
0x2560																
0x2570																
0x2580																
0x2590																
0x25A0																
0x25B0																
0x25C0	192 x Kta, Kv (i, j)															
0x25D0																
0x25E0																
0x25F0																
0x2600																
0x2610																
0x2620																
0x2630																
0x2640																
0x2650																
0x2660																
0x2670																
0x2680	192 x Pixel offset - subpage 2															
0x2690																
0x26A0																
0x26B0																
0x26C0																
0x26D0																
0x26E0																
0x26F0																
0x2700																
0x2710																
0x2720																
0x2730																

Table 8 EEPROM overview (words)

Address \ bit	15	14	13	12	11	10	9	8	7	6	5	4	3	2	1	0
0x2410																MLX
0x2411																Scale_OCC_offset_range_1
0x2412																Pix_offset_part_1
0x2413																Pix_offset_part_2
0x2414																MLX
0x2415																Kta_avg
0x2416																Kta_scale_1
0x2417																Kta_scale_2
0x2418																Kv_avg
0x2419																Kta_scale_1
0x241A																Kta_scale_2
0x241B																Scale_row_1
0x241C																Scale_row_2
0x241D																Scale_row_3
0x241E																Scale_row_4
0x241F																Scale_row_5
0x2420																Scale_row_6
0x2421																Row_1_max
0x2422																Row_2_max
0x2423																Row_3_max
0x2424																Row_4_max
0x2425																Row_5_max
0x2426																Row_6_max
0x2427																KsTa (fixed scale 15)
0x2428																Emissivity ± 2
0x2429																GAIN - part 1
0x242A																GAIN - part 2
0x242B																Vdd_25 (fixed scale 5)
0x242C																K_Vdd (fixed scale 5)
0x242D																PTAT - part 1
0x242E																PTAT - part 2
0x242F																Kt_PTAT (fixed scale 3)
0x2430																Kv_PTAT (fixed scale 12)
0x2431																Alpha_PTAT (fixed scale 11)
0x2432																Alpha CP
0x2433																Alpha CP scale
0x2434																Offset CP - part 1
0x2435																Offset CP - part 2
0x2436																Kt CP scale
0x2437																Kv CP scale
0x2438																Kt CP
0x2439																Kv CP
0x243A																Cal resolution
0x243B																TGC coefficient ± 4
0x243C																KsTo scale
0x243D																± KsTo range 1 (-40°C ... -20°C)
0x243E																± KsTo range 2 (-20°C ... 0°C)
0x243F																± KsTo range 3 (0°C ... 80°C)
0x2440																± KsTo range 4 (80°C ... 120°C)
0x2441																± KsTo range 5 (120°C ... see 0x243A)
0x2442																Corner temp range 6
0x2443																± KsTo range 6 (see 0x243A ... see 0x243C)
0x2444																Corner temp range 7
0x2445																± KsTo range 7 (see 0x243C ... see 0x243E)
0x2446																Corner temp range 8
0x2447																± KsTo range 8 (see 0x243E ...)
0x2448																Offset pixel (1, 1) - subpage 0
0x2449																Offset pixel (1, 2) - subpage 0
0x244A																...
0x244B																Offset pixel (1, 15) - subpage 0
0x244C																Offset pixel (1, 16) - subpage 0
0x244D																Offset pixel (2, 1) - subpage 0
0x244E																Offset pixel (2, 2) - subpage 0
0x244F																...
0x2450																Offset pixel (12, 15) - subpage 0
0x2451																Offset pixel (12, 16) - subpage 0
0x2452																...
0x2453																Sensitivity (1, 1)
0x2454																Sensitivity (1, 2)
0x2455																...
0x2456																Sensitivity (1, 15)
0x2457																Sensitivity (1, 16)
0x2458																Sensitivity (2, 1)
0x2459																Sensitivity (2, 2)
0x245A																...
0x245B																Sensitivity (12, 15)
0x245C																Sensitivity (12, 16)
0x245D																Kta (1, 1)
0x245E																Kv (1, 1)
0x245F																Kta (1, 2)
0x2460																Kv (1, 2)
0x2461																...
0x2462																Kta (1, 15)
0x2463																Kv (1, 15)
0x2464																Kta (1, 16)
0x2465																Kv (1, 16)
0x2466																Kta (2, 1)
0x2467																Kv (2, 1)
0x2468																...
0x2469																Kta (12, 15)
0x246A																Kv (12, 15)
0x246B																Kta (12, 16)
0x246C																Kv (12, 16)
0x246D																Offset pixel (1, 1) - subpage 1
0x246E																Offset pixel (1, 2) - subpage 1
0x246F																...
0x2470																Offset pixel (1, 15) - subpage 1
0x2471																Offset pixel (1, 16) - subpage 1
0x2472																Offset pixel (2, 1) - subpage 1
0x2473																Offset pixel (2, 2) - subpage 1
0x2474																...
0x2475																Offset pixel (12, 15) - subpage 1
0x2476																Offset pixel (12, 16) - subpage 1

Table 9 Calibration parameters memory (EEPROM - bits)

**NOTE 1:** In case the pixel calibration data stored in EEPROM (Alpha, offset, Kta and Kv) is equal to 0x0000 this means that this particular pixels has failed and the calculation for To should not be trusted and avoided. Depending on the application, the To value for such pixels can be replaced with a default value such as - 273.15°C, can be equal to Ta or one calculate an average value from the adjacent pixels.

**NOTE 2:** The maximum number of deviating pixels is 1 (please check False pixel correction)

# 11. Calculating Object Temperature

## 11.1. Restoring calibration data from EERPOM and calculations

**NOTE:** 1. All data in the EEPROM are coded as two's complement (unless otherwise noted)  
 2. All EEPROM cells are coded using Hamming code for proper data restoring stored in the 5 most significant bits  
 3. The calculation below are considering only the "valid" data in any particular cell ignoring the Hamming code bits  
 i.e. as the five significant bits of each word "0" for instance if the EEPROM content is "0x9A44" we will work with "0x0244"  
 In the example we are restoring calibration data for pixel (6, 9)

The polynom for the Hamming code is as follows:

$$\begin{aligned}
 P0 &= D0 + D1 + D3 + D4 + D6 + D8 + D10 \\
 P1 &= D0 + D2 + D3 + D5 + D6 + D9 + D10 \\
 P2 &= D1 + D2 + D3 + D7 + D8 + D9 + D10 \\
 P3 &= D4 + D5 + D6 + D7 + D8 + D9 + D10 \\
 P4 &= D0 + D1 + D2 + D3 + D4 + D5 + D6 + D7 + D8 + D9 + D10 + P0 + P1 + P2 + P3
 \end{aligned}$$

Where P4 is the MSBit in the word while D0...D10 are the data bits.

B15	B14	B13	B12	B11	B10	B9	B8	B7	B6	B5	B4	B3	B2	B1	B0
P4	P3	P2	P1	P0	D10	D9	D8	D7	D6	D5	D4	D3	D2	D1	D0

Figure 15 EEPROM Hamming and data bit meaning

### 11.1.1. Restoring the VDD sensor parameters and VDD calculations

Following formula is used to calculate the VDD of the sensor:

$$V_{dd} = \frac{Resolution_{corr} * RAM[0x05AA] - V_{dd25}}{K_{Vdd}} + 3.3$$

$$\text{If } RAM[0x05AA] > 32767 \rightarrow RAM[0x05AA] = RAM[0x05AA] - 65536$$

Where:

$$K_{Vdd} = EE[0x2427] \& 0x07FF$$

$$\text{If } K_{Vdd} > 1023 \rightarrow K_{Vdd} = K_{Vdd} - 2048$$

$$K_{Vdd} = K_{Vdd} * 2^5$$

$$V_{dd25} = EE[0x2426] \& 0x07FF$$

$$\text{If } V_{dd25} > 1023 \rightarrow V_{dd25} = V_{dd25} - 2048$$

$$V_{dd25} = V_{dd25} * 2^5$$

Where  $Resolution_{corr}$  is restored in 11.1.18

## 11.1.2. Restoring the Ta sensor parameters

Following formula is used to calculate the Ta of the sensor:

$$T_a = \frac{\left( \frac{V_{PTAT_{art}} - V_{PTAT_{25}}}{1 + K_{V_{PTAT}} \cdot \Delta V} - V_{PTAT_{25}} \right)}{K_{T_{PTAT}}} + 25, \text{ } ^\circ\text{C}$$

Where:

$$K_{V_{PTAT}} = EE[0x242B] \& 0x07FF$$

$$\text{if } K_{V_{PTAT}} > 1023 \rightarrow K_{V_{PTAT}} = K_{V_{PTAT}} - 2048$$

$$K_{V_{PTAT}} = \frac{K_{V_{PTAT}}}{2^{12}}$$

$$K_{T_{PTAT}} = EE[0x242A] \& 0x07FF$$

$$\text{if } K_{T_{PTAT}} > 1023 \rightarrow K_{T_{PTAT}} = K_{T_{PTAT}} - 2048$$

$$K_{T_{PTAT}} = \frac{K_{T_{PTAT}}}{2^3}$$

$$\Delta V = \frac{RAM[0x05AA] - V_{dd_{25}}}{K_{V_{dd}}}$$

$$\text{if } RAM[0x05AA] > 32767 \rightarrow RAM[0x05AA] = RAM[0x05AA] - 65536$$

$$V_{PTAT_{25}} = 32 * (EE[0x2428] \& 0x07FF) + EE[0x2429] \& 0x07FF \text{ (unsigned)}$$

$$V_{PTAT_{art}} = \left( \frac{V_{PTAT}}{V_{PTAT} * \text{Alpha}_{PTAT} + V_{BE}} \right) * 2^{18}$$

Where:

$$V_{PTAT} = RAM[0x05A0]$$

$$\text{if } V_{PTAT} > 32767 \rightarrow V_{PTAT} = V_{PTAT} - 65536$$

$$V_{BE} = RAM[0x0580]$$

$$\text{if } V_{BE} > 32767 \rightarrow V_{BE} = V_{BE} - 65536$$

$$\text{Alpha}_{PTAT} = \frac{EE[0x242C] \& 0x07FF}{2^7}$$

## 11.1.3. Restoring the offset

There are two sets of offset data for each subpage.

$$pix_{OS_{ref\_SP0}}(i,j) = \text{Offset}_{average} + \text{offset}_{SP0}(6,9) * 2^{\text{Offset}_{scale}}$$

$$pix_{OS_{ref\_SP1}}(i,j) = \text{Offset}_{average} + \text{offset}_{SP1}(6,9) * 2^{\text{Offset}_{scale}}$$

$$Offset_{average} = 32 * (EE[0x2411] \& 0x07FF) + EE[0x2412] \& 0x07FF$$

$$\text{If } Offset_{average} > 32767 \rightarrow Offset_{average} = Offset_{average} - 65536$$

$$offset_{SP0}(6, 9) = EE[0x2498] \& 0x07FF$$

$$\text{If } offset_{SP0}(6, 9) > 1023 \rightarrow offset_{SP0}(6, 9) = offset_{SP0}(6, 9) - 2048$$

$$offset_{SP1}(6, 9) = EE[0x26D8] \& 0x07FF$$

$$\text{If } offset_{SP1}(6, 9) > 1023 \rightarrow offset_{SP1}(6, 9) = offset_{SP1}(6, 9) - 2048$$

$$Offset_{scale} = \frac{EE[0x2410] \& 0x07E0}{2^5} \text{ (unsigned)}$$

### 11.1.4. Restoring the Sensitivity $\alpha_{(i,j)}$

Sensitivity is divided into 6 ranges (1...32, 33...64 and so on) and for each range we store a reference value as follows:

Sensitivity Max value for row 1 (pixels 1...32) is stored at EEPROM address 0x241C

Sensitivity Max value for row 2 (pixels 33...64) is stored at EEPROM address 0x241D

Sensitivity Max value for row 3 (pixels 65...96) is stored at EEPROM address 0x241E

Sensitivity Max value for row 4 (pixels 97...128) is stored at EEPROM address 0x241F

Sensitivity Max value for row 5 (pixels 129...160) is stored at EEPROM address 0x2420

Sensitivity Max value for row 6 (pixels 161...192) is stored at EEPROM address 0x2421

$$\alpha_{(i,j)} = \frac{\alpha_{pixel}(6,9)}{2^{11-1}} * \alpha_{reference}$$

Where:

$$\alpha_{pixel}(6, 9) = EE[0x2538] \& 0x07FF$$

$$\alpha_{reference_{row1}} = \frac{EE[0x241C] \& 0x07FF}{2^{\alpha_{scale_{row1}}}}$$

$$\alpha_{scale_{row1}} = \frac{EE[0x2419] \& 0x07E0}{2^5} + 20$$

$$\alpha_{reference_{row2}} = \frac{EE[0x241D] \& 0x07FF}{2^{\alpha_{scale_{row2}}}}$$

$$\alpha_{scale_{row2}} = EE[0x2419] \& 0x001F + 20$$

$$\alpha_{reference_{row3}} = \frac{EE[0x241E] \& 0x07FF}{2^{\alpha_{scale_{row3}}}}$$

$$\alpha_{scale_{row3}} = \frac{EE[0x241A] \& 0x07E0}{2^5} + 20$$

$$\alpha_{reference_{row4}} = \frac{EE[0x241F] \& 0x07FF}{2^{\alpha_{scale_{row4}}}}$$

$$\alpha_{scale_{row4}} = EE[0x241A] \& 0x001F + 20$$

$$\alpha_{reference_{row5}} = \frac{EE[0x2420] \& 0x07FF}{2^{\alpha_{scale_{row5}}}}$$

$$\alpha_{scale_{row5}} = \frac{EE[0x241B] \& 0x07E0}{2^5} + 20$$

$$\alpha_{reference_{row6}} = \frac{EE[0x2421] \& 0x07FF}{2^{\alpha_{scale_{row6}}}}$$

$$\alpha_{scale_{row6}} = EE[0x241B] \& 0x001F + 20$$

### 11.1.5. Restoring the K<sub>Ta</sub>(i,j) coefficient

$$K_{Ta(6,9)} = \frac{K_{Ta_{EE}(6,9)} * 2^{K_{Ta_{scale2}}} + K_{Ta_{AVERAGE}}}{2^{K_{Ta_{scale1}}}}$$

Where:

$$K_{Ta_{EE}(6,9)} = \frac{EE[0x2618] \& 0x07E0}{2^5} \text{ (depending on pixel number)}$$

$$\text{If } K_{Ta_{EE}(6,9)} > 31 \rightarrow K_{Ta_{EE}(6,9)} = K_{Ta_{EE}(6,9)} - 64$$

$$K_{Ta_{AVERAGE}} = EE[0x2415] \& 0x07FF$$

$$\text{If } K_{Ta_{AVERAGE}} > 1023 \rightarrow K_{Ta_{AVERAGE}} = K_{Ta_{AVERAGE}} - 2048$$

$$K_{Ta_{scale1}} = \frac{EE[0x2416] \& 0x07E0}{2^5} \text{ (unsigned)}$$

$$K_{Ta_{scale2}} = EE[0x2416] \& 0x001F \text{ (unsigned)}$$

### 11.1.6. Restoring the K<sub>V</sub>(i,j) coefficient

$$K_{V(6,9)} = \frac{K_{V_{EE}(6,9)} * 2^{K_{V_{scale2}}} + K_{V_{AVERAGE}}}{2^{K_{V_{scale1}}}}$$

Where:

$$K_{V_{EE}(6,9)} = EE[0x2618] \& 0x001F \text{ (depending on pixel number)}$$

$$\text{If } K_{V_{EE}(6,9)} > 15 \rightarrow K_{V_{EE}(6,9)} = K_{V_{EE}(6,9)} - 32$$

$$K_{V_{AVERAGE}} = EE[0x2417] \& 0x07FF$$

$$\text{If } K_{V_{AVERAGE}} > 1023 \rightarrow K_{V_{AVERAGE}} = K_{V_{AVERAGE}} - 2048$$

$$K_{V_{scale1}} = \frac{EE[0x2418] \& 0x07E0}{2^5} \text{ (unsigned)}$$

$$K_{V_{scale2}} = EE[0x2418] \& 0x001F \text{ (unsigned)}$$



### 11.1.7. Restoring the GAIN coefficient (common for all pixel)

$$GAIN = 32 * (EE[0x2424] \& 0x07FF) + EE[0x2425] \& 0x07FF \text{ (unsigned)}$$

### 11.1.8. Restoring the KsTa coefficient (common for all pixel)

$$KsTa = EE[0x2422] \& 0x07FF$$

$$\text{If } KsTa > 1023 \rightarrow KsTa = KsTa - 2048$$

$$KsTa = \frac{KsTa}{2^{15}}$$

### 11.1.9. Restoring corner temperatures (common for all pixel)

The information regarding corner temperatures is stored into device EEPROM and is restored as follows:

$$CT6 = EE[0x243A] \& 0x07FF \text{ (unsigned)}$$

$$CT7 = EE[0x243C] \& 0x07FF \text{ (unsigned)}$$

$$CT8 = EE[0x243E] \& 0x07FF \text{ (unsigned)}$$

Or we can construct the temperatures for the ranges as follows:

$$CT1 = -40^{\circ}\text{C (hard coded)} < \text{Range 1} > CT2 = -20^{\circ}\text{C (hard coded)} < \text{Range 2} > CT3 = 0^{\circ}\text{C (hard coded)} < \text{Range 3} > CT4 = 80^{\circ}\text{C (hard coded)} < \text{Range 4} > CT5 = 120^{\circ}\text{C (hard coded)} < \text{Range 5} > CT6 < \text{Range 6} > CT7 < \text{Range 7} > CT8 < \text{Range 8}$$

### 11.1.10. Restoring the KsTo coefficient (common for all pixel)

$$KsTo_1 = \frac{EE[0x2435] \& 0x07FF}{2^{KsTo_{scale}}}$$

$$\text{If } KsTo_1 > 1023 \rightarrow KsTo_1 = KsTo_1 - 2048$$

$$KsTo_2 = \frac{EE[0x2436] \& 0x07FF}{2^{KsTo_{scale}}}$$

$$\text{If } KsTo_2 > 1023 \rightarrow KsTo_2 = KsTo_2 - 2048$$

$$KsTo_3 = \frac{EE[0x2437] \& 0x07FF}{2^{KsTo_{scale}}}$$

$$\text{If } KsTo_3 > 1023 \rightarrow KsTo_3 = KsTo_3 - 2048$$

$$KsTo_4 = \frac{EE[0x2438] \& 0x07FF}{2^{KsTo_{scale}}}$$

$$\text{If } KsTo_4 > 1023 \rightarrow KsTo_4 = KsTo_4 - 2048$$

$$KsTo_5 = \frac{EE[0x2439] \& 0x07FF}{2^{KsTo_{scale}}}$$

$$\text{If } KsTo_5 > 1023 \rightarrow KsTo_5 = KsTo_5 - 2048$$

$$KsTo_6 = \frac{EE[0x243B] \& 0x07FF}{2^{KsTo_{scale}}}$$

$$\text{If } KsTo_6 > 1023 \rightarrow KsTo_6 = KsTo_6 - 2048$$

$$KsTo_7 = \frac{EE[0x243D] \& 0x07FF}{2^{KsTo_{scale}}}$$

$$\text{If } KsTo_7 > 1023 \rightarrow KsTo_7 = KsTo_7 - 2048$$

$$KsTo_8 = \frac{EE[0x243F] \& 0x07FF}{2^{KsTo_{scale}}}$$

$$\text{If } KsTo_8 > 1023 \rightarrow KsTo_8 = KsTo_8 - 2048$$

Where:

$$KsTo_{scale} = EE[0x2434] \& 0x07FF \text{ (unsigned)}$$

### 11.1.11. Restoring sensitivity correction coefficients for each temperature range

$$Alpha_{corr_{range1}} = \frac{1}{(1 + KsTo1 * (CT2 - (CT1)))} * Alpha_{corr_{range2}}$$

$$Alpha_{corr_{range2}} = \frac{1}{(1 + KsTo2 * (CT3 - (CT2)))}$$

$$Alpha_{corr_{range3}} = 1$$

$$Alpha_{corr_{range4}} = (1 + KsTo3 * (CT4 - CT3))$$

$$Alpha_{corr_{range5}} = (1 + KsTo4 * (CT5 - CT4)) * Alpha_{corr_{range4}}$$

$$Alpha_{corr_{range6}} = (1 + KsTo5 * (CT6 - CT5)) * Alpha_{corr_{range5}}$$

$$Alpha_{corr_{range7}} = (1 + KsTo6 * (CT7 - CT6)) * Alpha_{corr_{range6}}$$

$$Alpha_{corr_{range8}} = (1 + KsTo7 * (CT8 - CT7)) * Alpha_{corr_{range7}}$$

### 11.1.12. Restoring Emissivity

An emissivity parameter is stored into EEPROM and can have values from -2...1.999

$$Emissivity = EE[0x2423] \& 0x07FF$$

$$\text{If } Emissivity > 1023 \rightarrow Emissivity = Emissivity - 2048$$

$$Emissivity = \frac{Emissivity}{2^9}$$

Default value stored in EEPROM is  $Emissivity = 1$

### 11.1.13. Restoring the Sensitivity $\alpha_{CP}$

$$\alpha_{CP} = \frac{EE[0x242D] \& 0x07FF}{2^{\alpha_{scale\_CP}}}$$

Where:

$$\alpha_{scale\_CP} = EE[0x242E] \& 0x07FF$$

### 11.1.14. Restoring the offset of the CP

$$Off\_CP = 32 * (EE[0x242F] \& 0x07FF) + EE[0x2430] \& 0x07FF \text{ (signed)}$$

$$\text{If } Off\_CP > 32767 \rightarrow Off\_CP = Off\_CP - 65536$$

### 11.1.15. Restoring the Kv CP coefficient

$$K_{V_{CP}} = \frac{K_{V_{CP\_EE}}}{2^{K_{V_{scale}}}}$$

$$K_{V_{scale}} = \frac{EE[0x2432] \& 0x07C0}{2^6} \text{ (unsigned)}$$

Where:

$$K_{V_{CP\_EE}} = EE[0x2432] \& 0x003F \text{ (signed)}$$

$$\text{If } K_{V_{CP\_EE}} > 31 \rightarrow K_{V_{CP\_EE}} = K_{V_{CP\_EE}} - 64$$

### 11.1.16. Restoring the Kta CP coefficient

$$K_{Ta_{CP}} = \frac{K_{Ta_{CP\_EE}}}{2^{K_{Ta_{scale\_1}}}}$$

$$K_{Ta_{scale\_1}} = \frac{EE[0x2431] \& 0x07C0}{2^6} \text{ (unsigned)}$$

Where:

$$K_{Ta_{CP\_EE}} = EE[0x2431] \& 0x003F \text{ (signed)}$$

$$\text{If } K_{Ta_{CP\_EE}} > 31 \rightarrow K_{Ta_{CP\_EE}} = K_{Ta_{CP\_EE}} - 64$$

### 11.1.17. Restoring the TGC coefficient

$$TGC = \frac{TGC_{EE}}{2^6}$$

Where:

$$TGC_{EE} = EE[0x2433] \& 0x01FF \text{ (signed)}$$

$$\text{If } TGC_{EE} > 255 \rightarrow TGC_{EE} = TGC_{EE} - 512$$

## 11.1.18. Restoring calibration resolution control settings

For some calculation calibration resolution is needed that is why we store this parameter into EEPROM as well.

$$Resolution_{EE} = \frac{EE[0x2433] \& 0x0600}{2^9} \text{ (unsigned)}$$

## 11.2. Temperature calculation

### 11.2.1. Example input data

#### 11.2.1.1. Example measurement data

Input data name	Input data value
Object temperature	80°C
Emissivity (ε)	0.95
Control register 1 (Res <sub>ctrl</sub> )	0x0901 (2 decimal)
RAM[0x0498] (pix(6, 9) data)	0x03CC (972)
Vbe - RAM[0x0580]	0x4C54 (19540)
CP - RAM[0x0588]	0xFF97 (-105)
GAIN - RAM[0x058A]	0x2606 (9734)
PTAT - RAM[0x05A0]	0x06D8 (1752)
VDD - RAM[0x05AA]	0xCB8A (-13430)

Table 10 Calculation example input data

#### 11.2.1.2. Calibration data

EEPROM address	Calibration parameter name	Parameter value + Ham [ hex ]	Decoded value
0x2410	Scale_os_r1 - 6bits Scale_os_r2 - 5bits	0x0000	Scale_os_r1 = 0 Scale_os_r2 = 0
0x2411	Pix_os_r1_part_1 - 11 bits	0xB7E8	-746
0x2412	Pix_os_r1_part_2 - 11 bits	0xD016	NA
0x2413	MLX		
0x2414	MLX		
0x2415	Kta_avg - 11 bits	0xC2FD	0.00291824
0x2416	Kta_scale_1 - 6 bits Kta_scale_2 - 5 bits	0x1A43	Kta_scale_1 = 18 Kta_scale_2 = 3

0x2417	Kv_avg - 11bits	0xCA9A	0.325195313
0x2418	Kv_scale_1 - 6 bits Kv_scale_2 - 5 bits	0x5164	Kv_scale_1 = 11 Kv_scale_2 = 4
0x2419	Scale_row_1 - 6 bits Scale_row_2 - 5 bits	0x018C	Scale_row_1 = 32 Scale_row_2 = 32
0x241A	Scale_row_3 - 6 bits Scale_row_4 - 5 bits	0x018C	Scale_row_3 = 32 Scale_row_4 = 32
0x241B	Scale_row_5 - 6 bits Scale_row_6 - 5 bits	0x018C	Scale_row_5 = 32 Scale_row_6 = 32
0x241C	row1_max - 11 bits	0x9CB1	2.7962960E-07
0x241D	row2_max - 11 bits	0x956C	3.2316893E-07
0x241E	row3_max - 11 bits	0xA5CC	3.4552068E-07
0x241F	row4_max - 11 bits	0x7DD1	3.4668483E-07
0x2420	row5_max - 11 bits	0x6D7F	3.2759272E-07
0x2421	row6_max - 11 bits	0x3CD4	2.8777868E-07
0x2422	KsTa, fixed scale 15	0x27B8	-0.002197266
0x2423	Emissivity - $\pm 2$ , 10 bits	0x19E6	0.94921875
0x2424	GainMeasRef_word1	0xF137	9972
0x2425	GainMeasRef_word2	0x7814	NA
0x2426	Vdd_25	0x2658	-13568
0x2427	K_Vdd	0xEF9E	-3136
0x2428	PTAT_25_W1	0x917F	12280
0x2429	PTAT_25_W2	0xF018	NA
0x242A	Kt_Ptat	0xE156	42.75
0x242B	Kv_Ptat	0x4817	0.005615234
0x242C	Alpha PTAT	0x1C80	9
0x242D	Alpha cyclops	0x233E	3.0195224E-09
0x242E	Alpha cyclop scale	0xC826	38
0x242F	Offset CP W1	0xCFFC	-119
0x2430	Offset CP W2	0xA009	NA
0x2431	Kta CP scale - 5 bits Kta CP - 6 bits	0xBB53	Kta CP scale = 13 Kta CP = -0.02319336
0x2432	Kv CP scale - 5 bits Kv CP - 6 bits	0xF194	Kv CP scale = 6 Kv CP = 0.3125

0x2433	Resolution control cal - 2 bits TGC - $\pm 4$ , 9 bits	0xFC00	Resolution control cal = 2 TGC = 0
0x2434	KsTo scale - 11bits	0x7814	KsTo scale = 20
0x2435	KsTo_1 - 10 bits	0xED22	KsTo_1 = -0.0007
0x2436	KsTo_2 - 10 bits	0xED22	KsTo_2 = -0.0007
0x2437	KsTo_3 - 10 bits	0xED22	KsTo_3 = -0.0007
0x2438	KsTo_4 - 10 bits	0xED22	KsTo_4 = -0.0007
0x2439	KsTo_5 - 10 bits	0xED22	KsTo_5 = -0.0007
0x243A	CT6	0x80C8	CT6 = 200
0x243B	KsTo_6 - 10 bits	0xED22	KsTo_6 = -0.0007
0x243C	CT7	0x4190	CT6 = 400
0x243D	KsTo_7 - 10 bits	0xED22	KsTo_7 = -0.0007
0x243E	CT8	0xDA58	CT6 = 600
0x243F	KsTo_8 - 10 bits	0xED22	KsTo_8 = -0.0007

*Table 11 Calculation example calibration data*

## 11.2.2. Temperature calculation

After the parameters restore the temperature calculation is done using following calculation flow (assuming that the EEPROM data are already extracted):



Figure 16 To calculation flow

For this example we calculate the temperature of pixel (12, 16) i.e. row=12 and the column=16.

Values marked with green are extracted from device EEPROM

Values marked with grey are final parameter values or are values to be used for next calculations

### 11.2.2.1. Resolution restore

The device is calibrated with default resolution setting = 2 (corresponding to ADC resolution set to 18bit see Fig 11) i.e. if the one choose to change the ADC resolution setting to a different one a correction of the data must be done. First we must restore the resolution at which the device has been calibrated which is stored at EEPROM 0x2433.

$$Resolution_{corr} = \frac{2^{Resolution_{EE}}}{2^{Resolution_{REG}}}$$

Where:

$$Resolution_{EE} = \frac{EF[0x2433] \& 0x0600}{2^9} = \frac{0x7C00 \& 0x0600}{2^9} = 0x0002 = 2 \text{ (unsigned)}$$

$$Resolution_{REG} = \frac{RAM[0x800D] \& 0x0C00}{2^{10}} = \frac{0x1901 \& 0x0C00}{2^{10}} = 0x0002 = 2 \text{ (unsigned)}$$

$$Resolution_{corr} = \frac{2^{Resolution_{EE}}}{2^{Resolution_{REG}}} = \frac{2^2}{2^2} = 1$$

In case the ADC resolution is changed the one must multiply the  $Resolution_{corr}$  coefficient with the RAM data for VDD only. Please note that the data for Vbe, PTAT and IR pixels (including CP) **must** not be changed.

### 11.2.2.2. Supply voltage value calculation (common for all pixel)

$$V_{dd} = \frac{Resolution_{corr} * RAM[0x05AA] - V_{dd_{25}}}{K_{V_{dd}}} + V_{dd_0}$$

$$RAM[0x05AA] = 0xCB8A = 52106$$

$$\text{If } 52883 > 32767 \rightarrow RAM[0x05AA] = 52106 - 65536 = -13430 \text{ LSB}$$

Where:

$$K_{V_{dd}} = EE[0x2427] \& 0x07FF = 0xEF9E \& 0x07FF = 0x079E = 1950$$

$$\text{If } 1950 > 1023 \rightarrow K_{V_{dd}} = 1950 - 2048 = -98$$

$$K_{V_{dd}} = K_{V_{dd}} * 2^5 = -98 * 32 = -3136$$

$$V_{dd_{25}} = EE[0x2426] \& 0x07FF = 0x2658 \& 0x07FF = 0x0658 = 1624$$

$$\text{If } 1624 > 1023 \rightarrow V_{dd_{25}} = 1624 - 2048 = -424$$

$$V_{dd_{25}} = V_{dd_{25}} * 2^5 = -424 * 32 = -13568$$

$$V_{dd} = \frac{-13430 - (-13568)}{-3136} + 3.3 = \frac{138}{-3136} + 3.3 \approx -0.0440051 + 3.3 \approx 3.25599 \text{ V}$$

### 11.2.2.3. Ambient temperature calculation (common for all pixel)

$$T_a = \frac{\left( \frac{V_{PTAT_{art}}}{1 + K_{V_{PTAT}} * \Delta V} - V_{PTAT_{25}} \right)}{K_{T_{PTAT}}} + 25, \text{ } ^\circ\text{C}$$

Where:

$$K_{V_{PTAT}} = EE[0x242B] \& 0x07FF = 0x4817 \& 0x07FF = 0x0017 = 23$$

$$\text{If } 23 < 1023 \rightarrow K_{V_{PTAT}} = 23$$

$$K_{V_{PTAT}} = \frac{K_{V_{PTAT}}}{2^{12}} = \frac{23}{4096} = 0.005615234$$

$$K_{T_{PTAT}} = EE[0x242A] \& 0x07FF = 0xE156 \& 0x07FF = 0x0156 = 342$$

$$\text{If } 342 < 1023 \rightarrow K_{T_{PTAT}} = 342$$

$$K_{T_{PTAT}} = \frac{K_{T_{PTAT}}}{2^3} = \frac{342}{8} = 42.75$$



$$\Delta V = \frac{RAM[0x05AA] - V_{dd25}}{K_{V_{dd}}}$$

$$RAM[0x05AA] = 0xCB8A = 52106$$

$$\text{If } 52883 > 32767 \rightarrow RAM[0x05AA] = 52106 - 65536 = -13430 \text{ LSB}$$

$$\Delta V = \frac{-13430 - (-13568)}{-3136} = \frac{138}{-3136} \approx -0.0440051$$

$$V_{PTAT_{25}} = 32 * (EE[0x2428] \& 0x07FF) + EE[0x2429] \& 0x07FF \text{ (unsigned)}$$

$$V_{PTAT_{25}} = 32 * (0x917F \& 0x07FF) + 0xF018 \& 0x07FF$$

$$V_{PTAT_{25}} = 32 * 0x017F + 0x0018 = 32 * 383 + 24 = 12256 + 24 = 12280$$

$$V_{PTAT_{art}} = \left( \frac{V_{PTAT}}{V_{PTAT} * \alpha_{PTAT} + V_{BE}} \right) * 2^{18}$$

Where:

$$V_{PTAT} = RAM[0x05A0] = 0x06D8 = 1752$$

$$\text{If } 1752 < 32767 \rightarrow V_{PTAT} = 1752$$

$$V_{BE} = RAM[0x0580] = 0x4C54 = 19540$$

$$\text{If } 19540 < 32767 \rightarrow V_{BE} = 19540$$

$$\alpha_{PTAT} = \frac{EE[0x242C] \& 0x07FF}{2^7} = \frac{0x1C80 \& 0x07FF}{2^7} = \frac{0x0480}{2^7} = \frac{1152}{128} = 9$$

$$V_{PTAT_{art}} = \left( \frac{V_{PTAT}}{V_{PTAT} * \alpha_{PTAT} + V_{BE}} \right) * 2^{18} = \left( \frac{1752}{1752 * 9 + 19540} \right) * 2^{18} = 13007.71$$

$$T_a = \frac{\left( \frac{V_{PTAT_{art}}}{1 + K_{V_{PTAT}} * \Delta V} - V_{PTAT_{25}} \right)}{K_{T_{PTAT}}} + 25 = \frac{\left( \frac{13007.71}{1 + 0.005615234 * -0.0440051} - 12280 \right)}{42.75} + 25 = 17.022 + 25 \approx 42.02 \text{ } ^\circ\text{C}$$

#### 11.2.2.4. Gain parameter calculation (common for all pixels)

$$K_{gain} = \frac{GAIN}{RAM[0x058A]}$$

$$RAM[0x058A] = 0x2606 = 9734$$

$$\text{If } 9734 < 32767 \rightarrow RAM[0x058A] = 9734 \text{ LSB}$$

$$GAIN = 32 * (EE[0x2424] \& 0x07FF) + EE[0x2425] \& 0x07FF \text{ (unsigned)}$$

$$GAIN = 32 * (0xF137 \& 0x07FF) + 0x7814 \& 0x07FF$$

$$GAIN = 32 * 0x0137 + 0x0014 = 32 * 311 + 20 = 9952 + 20 = 9972$$

$$K_{gain} = \frac{9972}{9734} = 1.02445038$$

### 11.2.2.5. Pixel data calculations

The pixel addressing is following the pattern described in Reading pattern as shown in Fig 5:

#### 11.2.2.5.1. Gain compensation

$$pix_{gain}(6, 9) = RAM[pixel\ data] * K_{gain} = RAM[0x0498] * K_{gain}$$

$$RAM[0x0498] = 0x03CC = 972$$

$$\text{If } 972 < 32767 \rightarrow RAM[0x0498] = 972$$

$$pix_{gain}(6, 9) = 972 * 1.02445038 = 995.761767708547$$

#### 11.2.2.5.2. Offset calculation

$$pix_{OS_{ref\_SP0}}(6, 9) = Offset_{average} + offset_{SP0}(6, 9) * 2^{Offset_{scale}}$$

$$Offset_{average} = 32 * (EE[0x2411] \& 0x07FF) + EE[0x2412] \& 0x07FF$$

$$Offset_{average} = 32 * (0x37E8 \& 0x07FF) + 0xD016 \& 0x07FF$$

$$Offset_{average} = 32 * 0x07E8 + 0x0016 = 32 * 2024 + 22 = 64768 + 22 = 64790$$

$$\text{If } 64790 < 32767 \rightarrow Offset_{average} = 64790 - 65536 = -746$$

$$offset_{SP0}(6, 9) = EE[0x2498] \& 0x07FF = 0xF849 \& 0x07FF = 0x0049 = 73$$

$$\text{If } 73 < 1023 \rightarrow offset_{SP0}(6, 9) = 73$$

$$Offset_{scale} = \frac{EE[0x2410] \& 0x07E0}{2^5} \text{ (unsigned)}$$

$$Offset_{scale} = \frac{0x0000 \& 0x07E0}{2^5} = \frac{0}{32} = 0$$

$$pix_{OS_{ref\_SP0}}(6, 9) = -746 + 73 * 2^0 = -673 \text{ LSB}$$

#### 11.2.2.5.3. IR data compensation – offset, VDD and Ta

$$pix_{OS_{SP0}}(6, 9) = pix_{gain}(6, 9) - pix_{OS_{ref\_SP0}} * \left(1 + K_{Ta(6,9)} * (T_a - T_{a0})\right) * \left(1 + K_{V(6,9)} * (V_{dd} - V_{dd0})\right)$$

The same calculation must be done for the second subpage as well

$$pix_{OS_{ref\_SP1}}(6, 9) = Offset_{average} + offset_{SP1}(6, 9) * 2^{Offset_{scale}}$$

$$offset_{SP1}(6, 9) = EE[0x26D8] \& 0x07FF = 0xF847 \& 0x07FF = 0x0047 = 71$$

$$\text{If } 71 < 1023 \rightarrow offset_{SP1}(6, 9) = 71$$

$$pix_{OS_{ref\_SP1}}(6, 9) = -746 + 71 * 2^0 = -675 \text{ LSB (} Offset_{average} \text{ and } Offset_{scale} \text{ are the same for both subpages)}$$

$$pix_{OS\_SP1}(6, 9) = pix_{gain}(6, 9) - pix_{OS\_ref\_SP1} * (1 + K_{Ta(6,9)} * (T_a - T_{a0})) * (1 + K_{V(6,9)} * (V_{dd} - V_{ddV0}))$$

NOTE: In the example bellow calculation are done for subpage 0 only

$$K_{Ta(6,9)} = \frac{K_{TaEE(6,9)} * 2^{K_{Ta\_scale2}} + K_{TaAVERAGE}}{2^{K_{Ta\_scale1}}}$$

Where:

$$K_{TaEE(6,9)} = \frac{EE[0x2619] \& 0x07E0}{2^5} \text{ (depending on pixel number)}$$

$$K_{TaEE(6,9)} = \frac{0xB8C0 \& 0x07E0}{2^5} = \frac{0x00C0}{2^5} = \frac{192}{32} = 6$$

$$\text{If } 6 < 31 \rightarrow K_{TaEE(6,9)} = 6$$

$$K_{TaAVERAGE} = EE[0x2415] \& 0x07FF = 0xC2FD \& 0x07FF = 02FD = 765$$

$$\text{If } 765 < 1023 \rightarrow K_{TaAVERAGE} = 765$$

$$K_{Ta\_scale1} = \frac{EE[0x2416] \& 0x07E0}{2^5} \text{ (unsigned)}$$

$$K_{Ta\_scale1} = \frac{0x2440 \& 0x07E0}{2^5} = \frac{0x0240}{2^5} = \frac{576}{32} = 18$$

$$K_{Ta\_scale2} = EE[0x2416] \& 0x001F \text{ (unsigned)}$$

$$K_{Ta\_scale2} = 0x1A43 \& 0x001F = 0x0003 = 3$$

$$K_{Ta(6,9)} = \frac{K_{TaEE(6,9)} * 2^{K_{Ta\_scale2}} + K_{TaAVERAGE}}{2^{K_{Ta\_scale1}}} = \frac{6 * 2^3 + 765}{2^{18}} = 0.003101349$$

$$K_{V(6,9)} = \frac{K_{V EE(6,9)} * 2^{K_{V\_scale2}} + K_{VAVERAGE}}{2^{K_{V\_scale1}}}$$

Where:

$$K_{V EE(6,9)} = EE[0x2618] \& 0x001F \text{ (depending on pixel number)}$$

$$K_{V EE(6,9)} = 0xB8C0 \& 0x001F = 0x0000 = 0$$

$$\text{If } 0 < 15 \rightarrow K_{V EE(6,9)} = 0$$

$$K_{VAVERAGE} = EE[0x2417] \& 0x07FF$$

$$K_{VAVERAGE} = 0xCA9A \& 0x07FF = 0x029A = 666$$

$$\text{If } 666 < 1023 \rightarrow K_{VAVERAGE} = 666$$

$$K_{Ta\_scale1} = \frac{EE[0x2418] \& 0x07E0}{2^5} \text{ (unsigned)}$$

$$K_{Ta\_scale1} = \frac{0x1600 \& 0x07E0}{2^5} = \frac{0x0160}{2^5} = \frac{384}{32} = 11$$

$$K_{Ta_{scale2}} = EE[0x2418] \& 0x001F \text{ (unsigned)}$$

$$K_{Ta_{scale2}} = 0x5164 \& 0x001F = 0x0004 = 4$$

$$K_{V(6,9)} = \frac{K_{V_{EE}(6,9)} * 2^{K_{V_{scale2}}} + K_{V_{AVERAGE}}}{2^{K_{V_{scale1}}}} = \frac{0 * 2^4 + 666}{2^{11}} = 0.3251953$$

$$pix_{OS\_SP0}(6,9) = pix_{gain}(6,9) - pix_{OS_{ref}} * (1 + K_{Ta(6,9)} * (T_a - T_{a0})) * (1 + K_{V(6,9)} * (V_{dd} - V_{ddV0}))$$

$$pix_{OS\_SP0}(6,9) = 995.761767708547 - (-673) * (1 + 0.00310135 * (42.02 - 25)) * (1 + 0.3251953 * (3.25599 - 3.3))$$

$$pix_{OS\_SP0}(6,9) = 995.761767708547 - (-673) * (1 + 0.00310135 * (42.02 - 25)) * (1 + 0.3251953 * (3.25599 - 3.3))$$

$$pix_{OS\_SP0}(6,9) = 1694.145767$$

#### 11.2.2.5.4. IR data Emissivity compensation

$$Emissivity = EE[0x2423] \& 0x07FF = 0x19E6 \& 0x07FF = 0x01E6 = 486$$

$$\text{If } 486 < 1023 \rightarrow Emissivity = 486$$

$$Emissivity = \frac{Emissivity}{2^9} = \frac{486}{512} = 0.949218$$

#### 11.2.2.6. CP data calculations

##### 11.2.2.6.1. Compensating the GAIN of CP pixel

$$pix_{gain}(6,9) = RAM[0x0588] * K_{gain}$$

$$RAM[0x0588] = 0xFF97 = 65431$$

$$\text{If } 65431 > 32767 \rightarrow RAM[0x0588] = 65431 - 65536 = -105$$

$$CP \text{ } pix_{gain} = -105 * 1.02445038 = -107.5672899$$

##### 11.2.2.6.2. Compensating offset, Ta and VDD of CP pixel

$$CP \text{ } pix_{OS} = CP \text{ } pix_{gain} - pix_{OS_{ref\_CP}} * (1 + K_{Ta\_CP} * (T_a - T_{a0})) * (1 + K_{V\_CP} * (V_{dd} - V_{ddV0}))$$

$$pix_{OS_{ref\_CP}} = 32 * (EE[0x242F] \& 0x07FF) + EE[0x2430] \& 0x07FF$$

$$pix_{OS_{ref\_CP}} = 32 * (0xCFFC \& 0x07FF) + 0xA009 \& 0x07FF$$

$$pix_{OS_{ref\_CP}} = 32 * 0x07FC + 0x0009 = 32 * 2044 + 9 = 65408 + 9 = 65417$$

$$\text{If } 65417 < 32767 \rightarrow pix_{OS_{ref\_CP}} = 65417 - 65536 = -119$$

$$K_{V_{CP}} = \frac{K_{V_{CP\_EE}}}{2^{K_{V_{scale}}}} = \frac{20}{2^6} = 0.3125$$

$$K_{V_{scale}} = \frac{EE[0x2432] \& 0x07C0}{2^6} = \frac{0xF194 \& 0x07C0}{2^6} = \frac{0x0180}{2^6} = \frac{384}{2^6} = 6 \text{ (unsigned)}$$

Where:

$$K_{V_{CP\_EE}} = EE[0x2432] \& 0x003F \text{ (signed)}$$

$$K_{V_{CP\_EE}} = 0xF194 \& 0x003F = 0x0014 = 20 \text{ (signed)}$$

$$\text{If } 20 < 31 \rightarrow K_{V_{CP\_EE}} = 20$$

$$K_{Ta_{CP}} = \frac{K_{Ta_{CP\_EE}}}{2^{K_{Ta_{scale\_1}}}} = \frac{19}{2^{13}} = 0.0023193359$$

$$K_{Ta_{scale\_1}} = \frac{EE[0x2431] \& 0x07C0}{2^6} = \frac{0xBB53 \& 0x07C0}{2^6} = \frac{0x0340}{2^6} = \frac{832}{2^6} = 13 \text{ (unsigned)}$$

Where:

$$K_{Ta_{CP\_EE}} = EE[0x2431] \& 0x003F = 0xBB53 \& 0x003F = 0x0013 = 19 \text{ (signed)}$$

$$\text{If } 19 < 31 \rightarrow K_{Ta_{CP\_EE}} = 19$$

$$CP \text{ pix}_{OS} = -107.5672899 - (-119) * (1 + 0.0023193359 * (42.02 - 25)) * (1 + 0.3125 * (3.25599 - 3.3))$$

$$CP \text{ pix}_{OS} = 14.42901896$$

### 11.2.2.7. IR data gradient compensation

$$TGC = \frac{TGC_{EE}}{2^6} = \frac{0}{2^6} = 0$$

Where:

$$TGC_{EE} = EE[0x2433] \& 0x01FF = 0x7C00 \& 0x01FF = 0x0000 = 0 \text{ (signed)}$$

$$\text{If } 0 < 255 \rightarrow TGC_{EE} = 0$$

$$V_{IR(6,9)COMPENSATED} = \frac{\text{pix}_{OS\_SP0(6,9)} - TGC * CP \text{ pix}_{OS}}{\varepsilon} = \frac{1694.145767 - 0 * 14.42901896}{0.949218} = 1784.78049 = 1785$$

### 11.2.2.8. Normalizing to sensitivity

$$\alpha_{(i,j)} = \frac{\alpha_{\text{pixel}(6,9)}}{2^{11-1}} * \alpha_{\text{reference}}$$

The row for the pixel is calculated as follows:

$$\text{Pixel}_{row} = \text{int} \left( \frac{((16 * (\text{row}_{number} - 1) + \text{column}_{number}) - 1)}{32} \right) + 1 = \text{int} \left( \frac{((16 * (6 - 1) + 9) - 1)}{32} \right) + 1 = \text{int} \left( \frac{88}{32} \right) + 1 = 3$$

$$\alpha_{\text{reference}_{row3}} = \frac{EE[0x241E] \& 0x07FF}{2^{\alpha_{\text{scale}_{row3}}}}$$

$$\alpha_{\text{scale}_{row3}} = \frac{EE[0x241A] \& 0x07E0}{2^5} + 20 = \frac{0x0180 \& 0x07E0}{2^5} + 20 = \frac{0x0180}{32} + 20 = \frac{384}{32} + 20 = 32$$

$$\alpha_{\text{reference}_{row3}} = \frac{EE[0x241E] \& 0x07FF}{2^{\alpha_{\text{scale}_{row3}}}} = \frac{0x4560 \& 0x07FF}{2^{32}} = \frac{0x05CC}{2^{32}} = \frac{1488}{2^{32}} = 3.45520675182343E - 07$$

$$\alpha_{\text{pixel}(6,9)} = EE[0x2558] \& 0x07FF = 0xFFFF \& 0x07FF = 0x07FF = 2047$$

$$\alpha_{(6,9)} = \frac{\alpha_{\text{pixel}(6,9)}}{2^{11-1}} * \alpha_{\text{reference}} = \frac{2047}{2047} * 3.45520675182343E - 07 = 3.45520675182343E - 07$$

$$\alpha_{CP} = \frac{EE[0x242E] \& 0x07FF}{2^{\alpha_{scale_{CP}}}}$$

$$\alpha_{scale_{CP}} = EE[0x242E] \& 0x07FF = 0xC826 \& 0x07FF = 0x0026 = 38$$

$$\alpha_{CP} = \frac{EE[0x242E] \& 0x07FF}{2^{38}} = \frac{0x242E \& 0x07FF}{2^{38}} = \frac{0x033E}{2^{38}} = \frac{830}{2^{38}} = 3.01952240988612E - 09$$

$$KsTa = EE[0x2422] \& 0x07FF = 0x27B8 \& 0x07FF = 0x07B8 = 1976$$

$$\text{If } 1976 > 1023 \rightarrow KsTa = 1976 - 2048 = -72$$

$$KsTa = \frac{KsTa}{2^{15}} = \frac{-72}{2^{15}} = -0.002197265625$$

$$\alpha_{comp(6,9)} = (\alpha_{(6,9)} - TGC * \alpha_{CP}) * (1 + KsTa * (T_a - T_{a0}))$$

$$\alpha_{comp(6,9)} = (3.45520675182343E - 07 - 0 * 3.01952240988612E - 09) * (1 + (-0.00219) * (42.02 - 25))$$

$$\alpha_{comp(6,9)} = 3.32641806639731E - 07$$

### 11.2.2.9. Calculating To for basic temperature range (0°C...80 °C)

$$KsTo_3 = EE[0x2437] \& 0x07FF = 0xED22 \& 0x07FF = 0x0522 = 1314$$

$$\text{If } 1314 > 1023 \rightarrow KsTo_3 = 1314 - 2048 = -734$$

$$KsTo_3 = \frac{-734}{2^{20}} = -0.000699997$$

Where:

$$KsTo_{scale} = EE[0x2434] \& 0x07FF \text{ (unsigned)}$$

$$KsTo_{scale} = 0x7814 \& 0x07FF = 0x0014 = 20$$

As the IR signal received by the sensor has two components:

1. IR signal emitted by the object
2. IR signal reflected from the object (the source of this signal is surrounding environment of the sensor)

In order to compensate correctly for the emissivity and achieve best accuracy we need to know the surrounding temperature which is responsible for the second component of the IR signal namely the reflected part -  $T_r$ . In case this  $T_r$  temperature is not available and cannot be provided it might be replaced by  $T_r \approx T_a - 5$ .

Let's assume  $T_r = 37^\circ\text{C}$ .

$$T_{aK^4} = (T_a + 273.15)^4 = (42.02 + 273.15)^4 = 315.87^4 = 9866871831.80621$$

$$T_{rK^4} = (T_r + 273.15)^4 = (37 + 273.15)^4 = 304.15^4 = 9253097577.685506$$

$$T_{a-r} = T_{rK^4} - \frac{T_{rK^4} - T_{aK^4}}{\epsilon} = 9253097577.685506 - \frac{9253097577.685506 - 9866871831.80621}{0.95} = 9899175739.92$$

$$S_{x(6,9)} = KsTo_3 * \sqrt[4]{\alpha_{comp(6,9)}^3 * V_{IR(6,9)COMPENSATED} + \alpha_{comp(6,9)}^4 * T_{a-r}}$$

$$S_{x(6,9)} = -0.000699997 * \sqrt[4]{3.32641806639731E - 07^3 * 1785 + 3.32641806639731E - 07^4 * 9899175739.92}$$

$$S_{x(6,9)} = -8.18463664533495E - 08$$

$$T_{O(6,9)} = \sqrt[4]{\frac{V_{IR(6,9)COMPENSATED}}{\alpha_{comp(6,9)} * (1 - K_{sTo3} * 273.15)} + S_{x(6,9)}} + T_{a-r} - 273.15$$

$$T_{O(6,9)} = \sqrt[4]{\frac{1785}{3.32641806639731E - 07 * (1 - (-0.000699997 * 273.15))} + S_{x(6,9)}} + 9899175739.92 - 273.15$$

$$T_{O(6,9)} = \sqrt[4]{\frac{1785}{3.143979442416E - 07}} + 9899175739.92 - 273.15$$

$$T_{O(6,9)} = \sqrt[4]{15576693779.3773} - 273.15 = 353.279812 - 273.15 = \mathbf{80.12} \text{ } ^\circ\text{C}$$

### 11.2.2.9.1. Calculations for extended temperature ranges

In order to extend the object temperature range and get the best possible accuracy an additional calculation cycle is needed. We can identify 8 object temperature ranges (each temperature range has its own so called Corner Temperature – CT which is the temperature at which the range starts):

- Object temperature range 1 = -40°C ... -20°C (Corner temperature for this range is -40°C and cannot be changed)
- Object temperature range 2 = -20°C ... 0°C (Corner temperature for this range is -20°C and cannot be changed)
- Object temperature range 3 = 0°C ... 80°C (Corner temperature for this range is 0°C and cannot be changed)
- Object temperature range 4 = 80°C ... 120°C (Corner temperature for this range is 80°C and cannot be changed)
- Object temperature range 5 = 120°C ... CT6°C (Corner temperature for this range is 120°C and cannot be changed)
- Object temperature range 6 = CT6°C ... CT7°C
- Object temperature range 7 = CT7°C ... CT8°C
- Object temperature range 8 = CT8°C ...

In order to be able to carry out temperature calculation for the ranges outside of temperature range 3 ( $T_o = 0^\circ\text{C} \dots 80^\circ\text{C}$ ) an additional parameters are needed and must be extracted from the device EEPROM. Those parameters are:

- So called corner temperature (CTx) i.e. the value of temperature at the beginning of the range. Please note that the corner temperatures for range 1 is fixed to -40°C, corner temperatures for range 2 is fixed to -20°C, corner temperatures for range 3 is fixed to 0°C, corner temperatures for range 4 is fixed to 80°C, corner temperatures for range 5 is fixed to 120°C while CT6, CT7 and CT8 are adjustable
- Sensitivity slope for each range –  $K_{sTo_x}$
- $T_{O(x,y)}$  calculated in 11.2.2.9

#### 11.2.2.9.1.1. Restoring corner temperatures

The information regarding corner temperatures is stored into device EEPROM and is restored as follows:

$$CT6 = \text{EE}[0x243A] \& 0x07FF = \mathbf{0x80C8} \& 0x07FF = 0x00C8 = \mathbf{200}^\circ\text{C}$$

$$CT7 = \text{EE}[0x243C] \& 0x07FF = \mathbf{0x4190} \& 0x07FF = 0x0190 = \mathbf{400}^\circ\text{C}$$

$$CT8 = \text{EE}[0x243E] \& 0x07FF = \mathbf{0xDA58} \& 0x07FF = 0x0258 = \mathbf{600}^\circ\text{C}$$

Or we can construct the temperatures for the ranges as follows:

CT1 = -40°C (hard coded) < Range 1 > CT2 = -20°C (hard coded) < Range 2 > CT3 = 0°C (hard coded) < Range 3 > CT4 = 80°C (hard coded) < Range 4 > CT5 = 120°C (hard coded) < Range 5 > CT6 < Range 6 > CT7 < Range 7 > CT8 < Range 8

### 11.2.2.9.1.2. Restoring the sensitivity slope for each range

$KsT_{o_{scale}} = 20$  has been extracted in 11.1.10

$$KsTo_1 = EE[0x2435] \& 0x07FF = 0xED22 \& 0x07FF = 0x0522 = 1314$$

$$\text{If } 1314 > 1023 \rightarrow KsTo_1 = 1314 - 2048 = -734$$

$$KsTo_1 = \frac{-734}{2^{20}} = -0.000699997$$

$$KsTo_2 = EE[0x2436] \& 0x07FF = 0xED22 \& 0x07FF = 0x0522 = 1314$$

$$\text{If } 1314 > 1023 \rightarrow KsTo_2 = 1314 - 2048 = -734$$

$$KsTo_2 = \frac{-734}{2^{20}} = -0.000699997$$

$$KsTo_4 = EE[0x2438] \& 0x07FF = 0xED22 \& 0x07FF = 0x0522 = 1314$$

$$\text{If } 1314 > 1023 \rightarrow KsTo_4 = 1314 - 2048 = -734$$

$$KsTo_4 = \frac{-734}{2^{20}} = -0.000699997$$

$$KsTo_5 = EE[0x2439] \& 0x07FF = 0xED22 \& 0x07FF = 0x0522 = 1314$$

$$\text{If } 1314 > 1023 \rightarrow KsTo_5 = 1314 - 2048 = -734$$

$$KsTo_5 = \frac{-734}{2^{20}} = -0.000699997$$

$$KsTo_6 = EE[0x243B] \& 0x07FF = 0xED22 \& 0x07FF = 0x0522 = 1314$$

$$\text{If } 1314 > 1023 \rightarrow KsTo_6 = 1314 - 2048 = -734$$

$$KsTo_6 = \frac{-734}{2^{20}} = -0.000699997$$

$$KsTo_7 = EE[0x243D] \& 0x07FF = 0xED22 \& 0x07FF = 0x0522 = 1314$$

$$\text{If } 1314 > 1023 \rightarrow KsTo_7 = 1314 - 2048 = -734$$

$$KsTo_7 = \frac{-734}{2^{20}} = -0.000699997$$

$$KsTo_8 = EE[0x243F] \& 0x07FF = 0xED22 \& 0x07FF = 0x0522 = 1314$$

$$\text{If } 1314 > 1023 \rightarrow KsTo_8 = 1314 - 2048 = -734$$

$$KsTo_8 = \frac{-734}{2^{20}} = -0.000699997$$

Now we can calculate sensitivity correction coefficients for each temperature range:



$$Alpha_{corr_{range1}} = \frac{1}{(1 + KsTo1 * (CT2 - (CT1)))} * Alpha_{corr_{range2}}$$

$$Alpha_{corr_{range1}} = \frac{1}{(1 - 0.000699997 * (-20 - (-40)))} * 1.014198721 = 1.014198721 * 1.014198721 = 1.028599$$

$$Alpha_{corr_{range2}} = \frac{1}{(1 + KsTo2 * (CT3 - (CT2)))} = \frac{1}{(1 - 0.000699997 * (0 - (-20)))} = 1.014198721$$

$$Alpha_{corr_{range3}} = 1$$

$$Alpha_{corr_{range4}} = (1 + KsTo3 * (CT4 - CT3)) = (1 - 0.000699997 * (80 - 0)) = 0.94400024$$

$$Alpha_{corr_{range5}} = (1 + KsTo4 * (CT5 - CT4)) * Alpha_{corr_{range4}}$$

$$Alpha_{corr_{range5}} = (1 - 0.000699997 * (120 - 80)) * 0.94400024 = 0.917568347$$

$$Alpha_{corr_{range6}} = (1 + KsTo5 * (CT6 - CT5)) * Alpha_{corr_{range5}}$$

$$Alpha_{corr_{range6}} = (1 - 0.000699997 * (200 - 120)) * 0.917568347 = 0.86618474$$

$$Alpha_{corr_{range7}} = (1 + KsTo6 * (CT7 - CT6)) * Alpha_{corr_{range6}}$$

$$Alpha_{corr_{range7}} = (1 - 0.000699997 * (400 - 200)) * 0.86618474 = 0.744919396$$

$$Alpha_{corr_{range8}} = (1 + KsTo7 * (CT8 - CT7)) * Alpha_{corr_{range7}}$$

$$Alpha_{corr_{range8}} = (1 - 0.000699997 * (600 - 400)) * 0.744919396 = 0.640631128$$

### 11.2.2.9.1.3. Extended To range calculation

The input parameter for this calculation is the object temperature calculated in Calculating To for basic temperature range (0°C...80 °C).

If  $T_{O(i,j)} < -20^{\circ}\text{C}$  we are in range 1 and we will use the parameters ( $Ks_{To1}$ ,  $Alpha_{corr_{range1}}$  and  $CT1 = -40^{\circ}\text{C}$ )

If  $-20^{\circ}\text{C} < T_{O(i,j)} < -40^{\circ}\text{C}$  we are in range 2 and we will use the parameters ( $Ks_{To2}$ ,  $Alpha_{corr_{range2}}$  and  $CT2 = -20^{\circ}\text{C}$ )

If  $0^{\circ}\text{C} < T_{O(i,j)} < 80^{\circ}\text{C}$  we are in range 3 and we will use the parameters ( $Ks_{To3}$ ,  $Alpha_{corr_{range3}}$  and  $CT3 = 0^{\circ}\text{C}$ )

If  $80^{\circ}\text{C} < T_{O(i,j)} < 120^{\circ}\text{C}$  we are in range 4 and we will use the parameters ( $Ks_{To4}$ ,  $Alpha_{corr_{range4}}$  and  $CT4 = 80^{\circ}\text{C}$ )

If  $120^{\circ}\text{C} < T_{O(i,j)} < CT6^{\circ}\text{C}$  we are in range 5 and we will use the parameters ( $Ks_{To5}$ ,  $Alpha_{corr_{range5}}$  and  $CT5 = 120^{\circ}\text{C}$ )

If  $CT6^{\circ}\text{C} < T_{O(i,j)} < CT7^{\circ}\text{C}$  we are in range 6 and we will use the parameters ( $Ks_{To6}$ ,  $Alpha_{corr_{range6}}$  and  $CT6 = 200^{\circ}\text{C}$ )

If  $CT7^{\circ}\text{C} < T_{O(i,j)} < CT8^{\circ}\text{C}$  we are in range 7 and we will use the parameters ( $Ks_{To7}$ ,  $Alpha_{corr_{range7}}$  and  $CT7 = 400^{\circ}\text{C}$ )

If  $CT8^{\circ}\text{C} < T_{O(i,j)}$  we are in range 8 and we will use the parameters ( $Ks_{To8}$ ,  $Alpha_{corr_{range8}}$  and  $CT8 = 600^{\circ}\text{C}$ )

$$T_{Oextra\_range(i,j)} = \sqrt[4]{\frac{V_{IR(i,j)COMPENSATED}}{\alpha_{comp(i,j)} * Alpha_{corr_{rangeX}} * (1 + Ks_{ToX} * (T_{O(i,j)} - CT_X))}} + T_{a-r} - 273.15$$

## 12. Performance graphs

### 12.1. Accuracy

#### 12.1.1. Pixel accuracy

All accuracy specifications apply under settled isothermal conditions only.

Furthermore, the accuracy is only valid if the object fills the FOV of the sensor completely.

Parameter definitions:

**Frame accuracy** is defined as average value of the all (768) pixels in the frame or for frame  $n$  can be expressed as:

$$\overline{T_{o\_frame(n)}} = \frac{1}{768} \sum_{m=1}^{768} T_o(m, n)$$

$$\text{Frame accuracy} = \overline{T_{o\_frame(n)}} - T_{target}$$

**Non-uniformity** is defined as the maximum deviation of each individual pixel reading vs. the absolute accuracy.

$$\text{Non Uniformity} = \text{MAX}(|T_o(m) - \overline{T_{o\_frame(n)}}|)$$

**Pixel absolute accuracy** is defined as:

$$T_{O\_accuracy(n)} = \text{Frame accuracy} + \text{Non Uniformity}$$

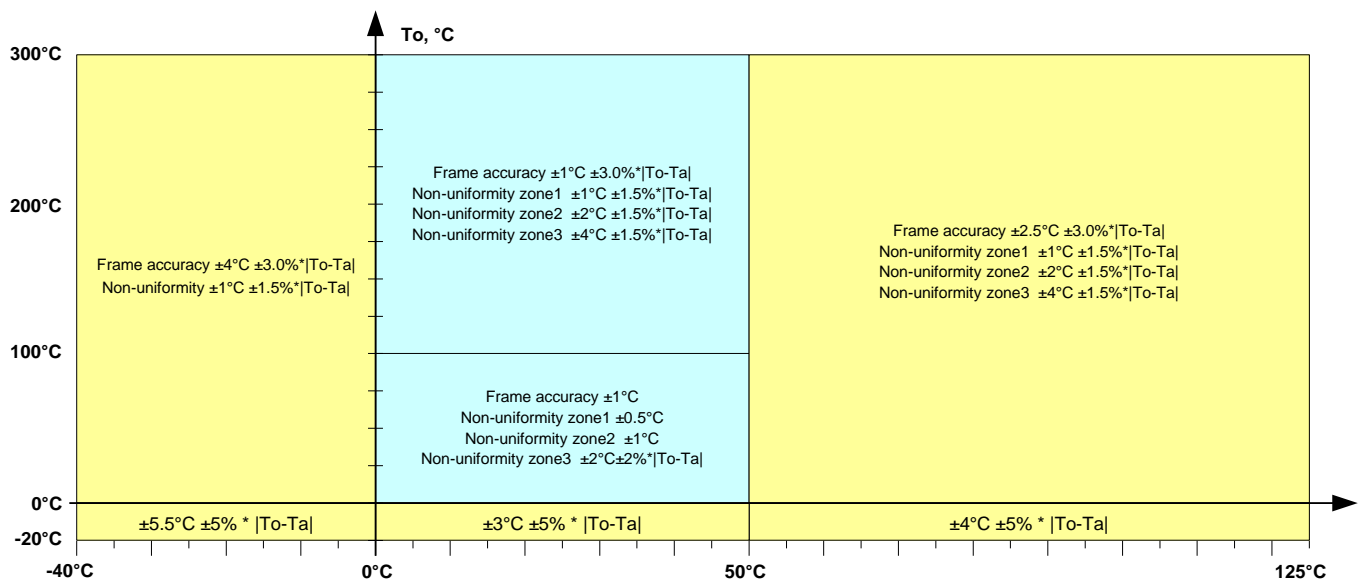

Figure 17 Temperature absolute accuracy - MLX90641BCA

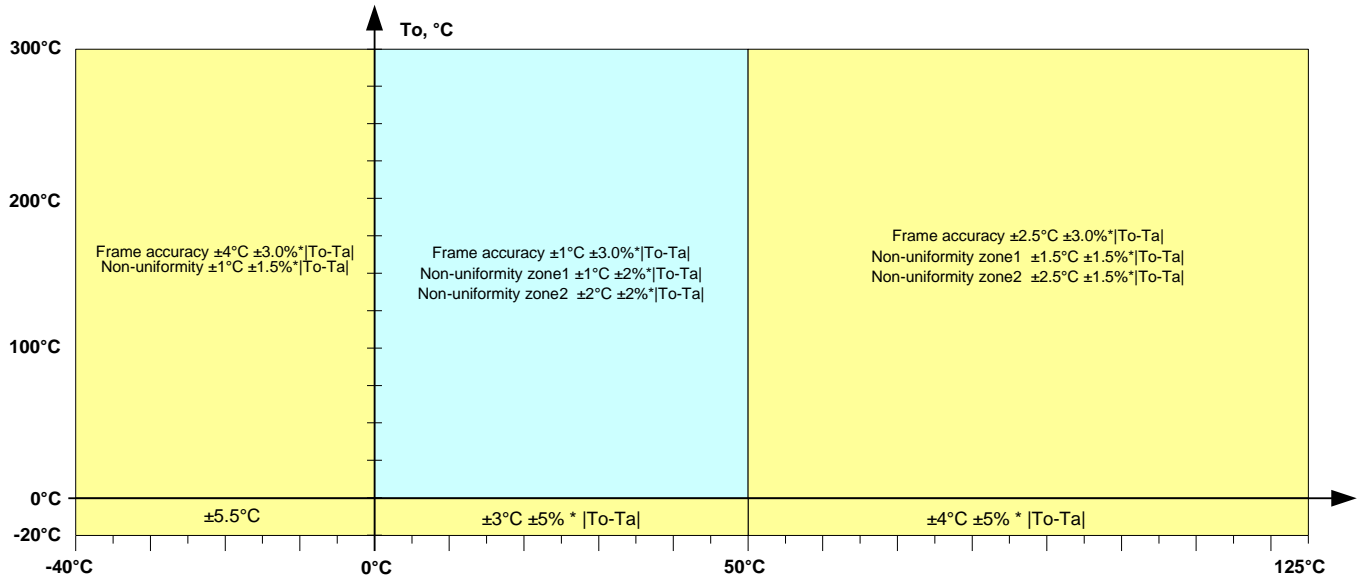

Figure 18 Temperature absolute accuracy - MLX90641BCB

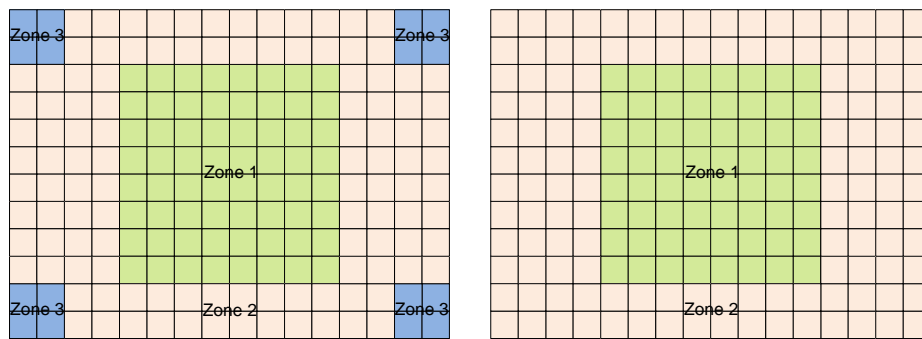

Figure 19 Different accuracy zones depending on device type (BCA on the left and BCB on the right)

Example: If we assume that the sensor (BCA type, zone 1) is measuring a target at 80°C that would mean that there should be no pixel with error bigger than:

$$T_{O_{accuracy}(n)} = \text{Frame accuracy} + \text{Non Uniformity} = \pm 1 \pm 0.5 = \pm 1.5^\circ\text{C}$$

NOTES:

- 1) For best performance it is recommended to keep the supply voltage as accurate and stable as possible to 3.3V ± 0.05V
- 2) As a result of long term (years) drift there can be an additional measurement deviation of ± 3°C for object temperatures around room temperature.

### 12.1.2. Ta accuracy

Absolute accuracy for the Ta channel (die temperature):

$$T_{Accuracy} = \pm 0.5^\circ\text{C}$$

NOTE: Actual sensor surrounding temperature would be approximately 5°C lower

## 12.2. Startup time

### 12.2.1. First valid data

After POR the first valid data is available after (depending on the selected refresh rate)  $T_{valid\_data}$  which is calculated as:

$$T_{valid\_data} = 80 + 2 * 500, \text{ ms} \quad (\text{Example refresh rate is 2Hz – the default value})$$

It is always subpage 0 to be measured first after POR then subpage 1 and so on alternating.

**NOTE1:** In case one changes the refresh rate on the fly (by writing new values into device register (0x800D)) the settings will take place only after the subpage under measurement is finished.

**NOTE2:** Although the first subpage is ready after 500ms it is necessary to have data from both subpages in order to be able to calculate the  $T_a$  meaning that the valid data are only possible after twice the refresh rate after POR.



### 12.2.2. Thermal behavior

Although electrically the device is set and running there is thermal stabilization time necessary before the device can reach the specified accuracy – up to 3 min.

## 12.3. Noise performance and resolution

There are two bits in the configuration register that allow changing the resolution of the MLX90641 measurements. Increasing the resolution decreases the quantization noise and improves the overall noise performance. Measurement conditions for the noise are:  $T_o=T_a=25^{\circ}\text{C}$

NOTE: Due to the nature of the thermal infrared radiation, it is normal that the noise will decrease for high temperature and increase for lower temperatures

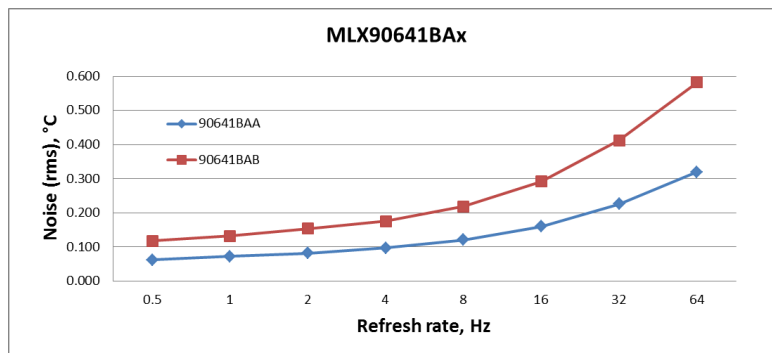

Figure 20 MLX90641BCx noise vs refresh rate for different device types

Not all pixels have the same noise performance. Because of the optical performance of the integrated lens, it is normal that the pixels in the corner of the frame are noisier in comparison with the pixels in the middle. The graphs below show the distribution of the noise density versus the pixel position in the frame (pixel number)

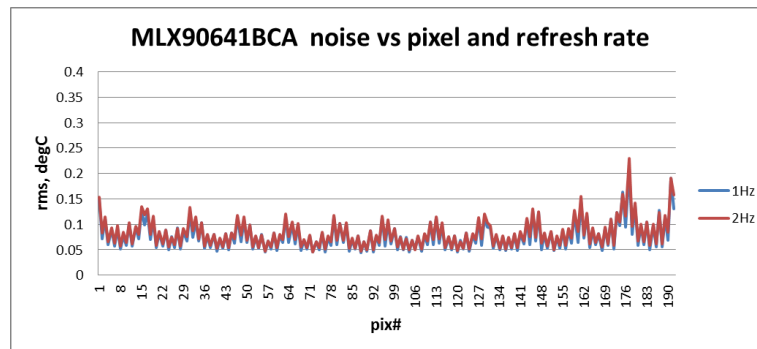

Figure 21 MLX90641BCA noise vs pixel and refresh rate at 1Hz and 2Hz

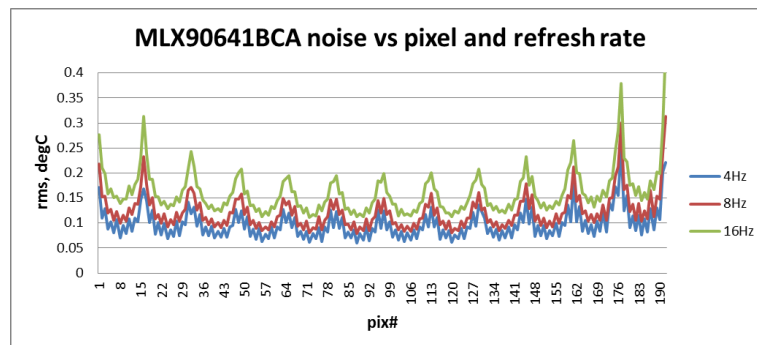

Figure 22 MLX90641BCA noise vs pixel and refresh rate at 4Hz, 8Hz and 16Hz



Figure 23 MLX90641BCB noise vs pixel and refresh rate at 1Hz and 2Hz



Figure 24 MLX90641BCB noise vs pixel and refresh rate at 4Hz, 8Hz and 16Hz

NETD (K)	1Hz RMS noise (temperature equivalent), all pixels		
MLX90641	Average	Min	Standard deviation
BCA	0.07	0.04	0.03
BCB	0.15	0.07	0.05

Table 12 Noise performance

## 12.4. Field of view (FOV)

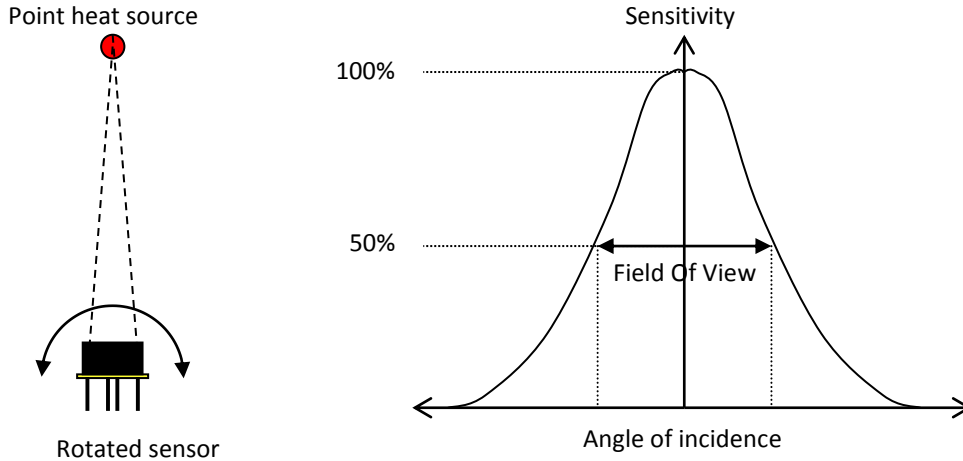

Figure 25 Field Of View measurement

The specified FOV is calculated for the wider direction, in this case for the 16 pixels.

FOV	X direction	Y direction	Central pointing from normal (X & Y direction)
	Typ	Typ	Max
MLX90641-ESF-BCA	110°	75°	5°
MLX90641-ESF-BCB	55°	35°	3°

Table 13 Available FOV options

## 13. Application information

### 13.1. Optical considerations

As this is an optical device a care must be taking such that the device performs according to the specification. One such parameter is FOV obstruction. It is paramount that the FOV in the optical path is kept clear. The external aperture is designed such to shape the FOV of the device and is installed prior calibration process thus can be considered as part of the device which does not impact the performance but may be used as a reference for the so called “Optical free zone” – see Figure 27 hereafter.



Figure 26 Application examples concerning the optical consideration

### 13.2. Electrical considerations

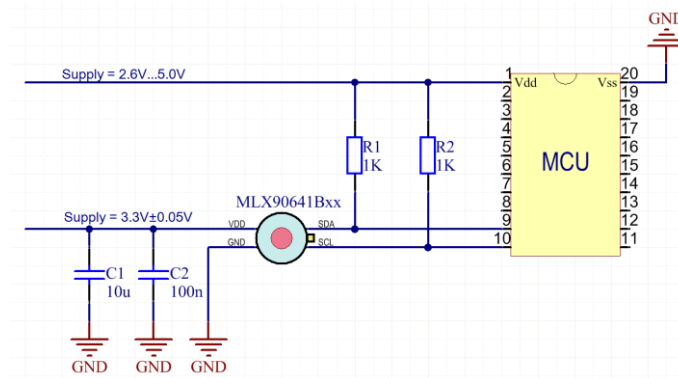

Figure 27 MLX90641Bxx electrical connections

As the MLX90641Bxx is fully I2C compatible it allows to have a system in which the MCU may be supplied with VDD=2.6V...5V while the sensor it's self is supplied from separate supply VDD1=3.3V (or even left with no supply i.e. VDD=0V), **with the I2C connection running at supply voltage of the MCU.**



### 13.3. Using the device in “image mode”

In some applications may not be necessary to calculate the temperature but rather to have just an image (for instance in machine vision systems). In this case it is not necessary to carry out all calculations which would save computation time or allow the one to use weaker CPU.

In order to get thermal image only following computation flow is to be used:

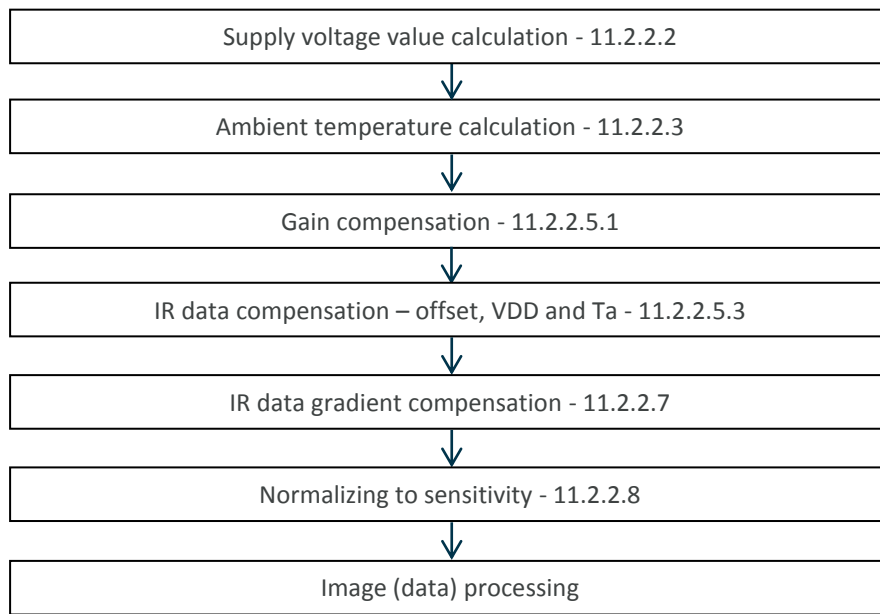

*Figure 28 Calculation flow in thermal image mode*

## 14. Application Comments

Significant **contamination** at the optical input side (sensor filter) might cause unknown additional filtering/distortion of the optical signal and therefore result in unspecified errors.

IR sensors are inherently susceptible to errors caused by **thermal gradients**. There are physical reasons for these phenomena and, in spite of the careful design of the MLX90641Bxx, it is recommended not to subject the MLX90641Bxx to heat transfer and especially transient conditions.

The MLX90641Bxx is designed and calibrated to operate as a non-contact thermometer in **settled conditions**. Using the thermometer in a very different way will result in unknown results.

**Capacitive loading** on an I2C can degrade the communication. Some improvement is possible with use of current sources compared to resistors in pull-up circuitry. Further improvement is possible with specialized commercially available bus accelerators. With the MLX90641Bxx additional improvement is possible by increasing the pull-up current (decreasing the pull-up resistor values). Input levels for I2C compatible mode have higher overall tolerance than the I2C specification, but the output low level is rather low even with the high-power I2C specification for pull-up currents. Another option might be to go for a slower communication (clock speed), as the MLX90641Bxx implements Schmidt triggers on its inputs in I2C compatible mode and is therefore not really sensitive to rise time of the bus (it is more likely the rise time to be an issue than the fall time, as far as the I2C systems are open drain with pull-up).

**Power dissipation** within the package may affect performance in two ways: by heating the “ambient” sensitive element significantly beyond the actual ambient temperature, as well as by causing gradients over the package that will inherently cause thermal gradient over the cap

**Power supply decoupling** capacitor is needed as with most integrated circuits. MLX90641Bxx is a mixed-signal device with sensors, small signal analog part, digital part and I/O circuitry. In order to keep the noise low power supply switching noise needs to be decoupled. High noise from external circuitry can also affect noise performance of the device. In many applications a 100nF SMD plus 10 $\mu$ F ceramic capacitors close to the Vdd and Vss pins would be a good choice. It should be noted that not only the trace to the Vdd pin needs to be short, but also the one to the Vss pin. Using MLX90641Bxx with short pins improves the effect of the power supply decoupling.

Check [www.melexis.com](http://www.melexis.com) for most recent application notes about MLX90641Bxx.

# 15. Mechanical drawings

## 15.1. FOV 55°

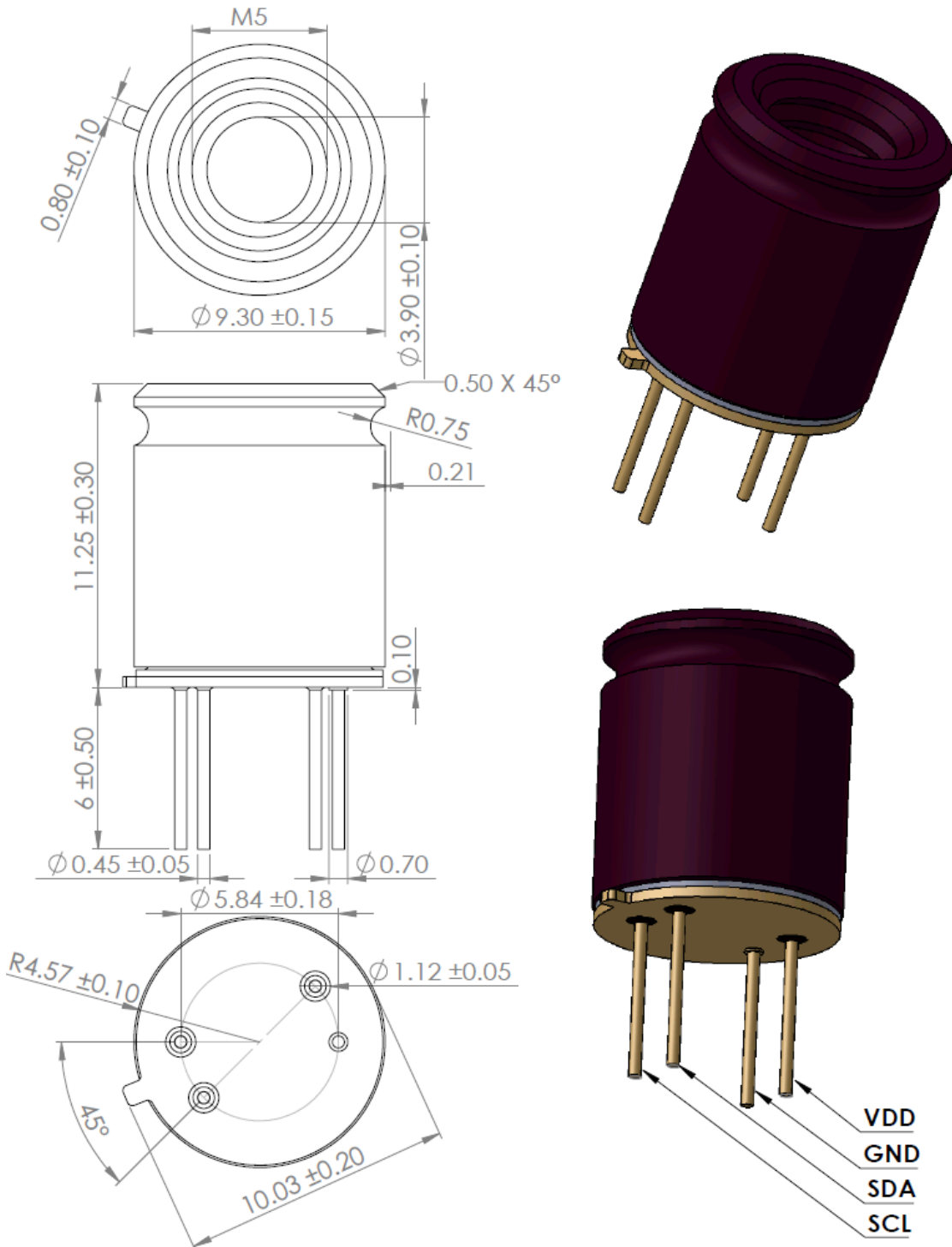

Figure 29 Mechanical drawing of 55° FOV device

## 15.2. FOV 110°



Figure 30 Mechanical drawing of 110° FOV device

### 15.3. Device marking

The MLX90641 is laser marked with 10 symbols as follows.

1	A	A	xxxxx	xx	Laser marking
					2 digits Split number
					5 digits LOT number
		A	FOV = 110°		
		B	FOV = 55°		
	A	Device without thermal gradient compensation (TGC = 0 and may not be changed)			
	C	Device with thermal gradient compensation (TGC = -4...+3.992)			
1	MLX90641				

- Example: “1CA1052801” – Device type MLX90641BCA from lot 10528, sub LOT split 1 and Thermal Gradient Compensation activated.

## 16. Standard Information

Our products are classified and qualified regarding soldering technology, solderability and moisture sensitivity level according to standards in place in Semiconductor industry.

For further details about test method references and for compliance verification of selected soldering method for product integration, Melexis recommends reviewing on our web site the General Guidelines [soldering recommendation](#). For all soldering technologies deviating from the one mentioned in above document (regarding peak temperature, temperature gradient, temperature profile etc), additional classification and qualification tests have to be agreed upon with Melexis.

For package technology embedding trim and form post-delivery capability, Melexis recommends to consult the dedicated trim&form recommendation application note: [lead trimming and forming recommendations](#)

Melexis is contributing to global environmental conservation by promoting **lead free** solutions. For more information on qualifications of **RoHS** compliant products (RoHS = European directive on the Restriction Of the use of certain Hazardous Substances) please visit the quality page on our website: <http://www.melexis.com/en/quality-environment>

## 17. ESD Precautions

Electronic semiconductor products are sensitive to Electro Static Discharge (ESD).

Always observe Electro Static Discharge control procedures whenever handling semiconductor products.

## 18. Revision History Table

25/07/2016	Initial release
12/08/2016	Calibration data stored into EEPROM, pixel reading modes explained
13/01/2017	Added CP data extraction, example updated, accuracy table
01/02/2017	Kta(i,j) and Kv(i,j) coefficients extraction from EEPROM corrected
15/12/2017	Overall rework
12/04/2018	extra temperature ranges calculations, new approach of Emissivity compensation
08/11/2018	Driver link, Max temp = 300°C, ESD = 4kV, step mode removed, FOV added,
06/02/2019	Emissivity compensation changed, added absolute accuracy for Ta
06/12/2019	Rev 3: long term accuracy note, optical consideration, package chamfer info, note regarding max current trough SDA driver, docserver number in the footer

*Table 14 Revision history*

## 19. Contact

For the latest version of this document, go to our website at [www.melexis.com](http://www.melexis.com).

For additional information, please contact our Direct Sales team and get help for your specific needs:

Europe, Africa	Telephone: +32 13 67 04 95
	Email : sales_europe@melexis.com
Americas	Telephone: +1 603 223 2362
	Email : sales_usa@melexis.com
Asia	Email : sales_asia@melexis.com

## 20. Disclaimer

*The information furnished by Melexis herein ("Information") is believed to be correct and accurate. Melexis disclaims (i) any and all liability in connection with or arising out of the furnishing, performance or use of the technical data or use of the product(s) as described herein ("Product") (ii) any and all liability, including without limitation, special, consequential or incidental damages, and (iii) any and all warranties, express, statutory, implied, or by description, including warranties of fitness for particular purpose, non-infringement and merchantability. No obligation or liability shall arise or flow out of Melexis' rendering of technical or other services.*

*The Information is provided "as is" and Melexis reserves the right to change the Information at any time and without notice. Therefore, before placing orders and/or prior to designing the Product into a system, users or any third party should obtain the latest version of the relevant information to verify that the information being relied upon is current. Users or any third party must further determine the suitability of the Product for its application, including the level of reliability required and determine whether it is fit for a particular purpose.*

*The Information is proprietary and/or confidential information of Melexis and the use thereof or anything described by the Information does not grant, explicitly or implicitly, to any party any patent rights, licenses, or any other intellectual property rights.*

*This document as well as the Product(s) may be subject to export control regulations. Please be aware that export might require a prior authorization from competent authorities.*

*The Product(s) are intended for use in normal commercial applications. Unless otherwise agreed upon in writing, the Product(s) are not designed, authorized or warranted to be suitable in applications requiring extended temperature range and/or unusual environmental requirements. High reliability applications, such as medical life-support or life-sustaining equipment are specifically not recommended by Melexis.*

*The Product(s) may not be used for the following applications subject to export control regulations: the development, production, processing, operation, maintenance, storage, recognition or proliferation of 1) chemical, biological or nuclear weapons, or for the development, production, maintenance or storage of missiles for such weapons; 2) civil firearms, including spare parts or ammunition for such arms; 3) defense related products, or other material for military use or for law enforcement; 4) any applications that, alone or in combination with other goods, substances or organisms could cause serious harm to persons or goods and that can be used as a means of violence in an armed conflict or any similar violent situation.*

*The Products sold by Melexis are subject to the terms and conditions as specified in the Terms of Sale, which can be found at <https://www.melexis.com/en/legal/terms-and-conditions>.*

*This document supersedes and replaces all prior information regarding the Product(s) and/or previous versions of this document.*

*Melexis NV © - No part of this document may be reproduced without the prior written consent of Melexis. (2016)*

*ISO/TS 16949 and ISO14001 Certified*

## Данный компонент на территории Российской Федерации

### Вы можете приобрести в компании MosChip.

Для оперативного оформления запроса Вам необходимо перейти по данной ссылке:

<http://moschip.ru/get-element>

Вы можете разместить у нас заказ для любого Вашего проекта, будь то серийное производство или разработка единичного прибора.

В нашем ассортименте представлены ведущие мировые производители активных и пассивных электронных компонентов.

Нашей специализацией является поставка электронной компонентной базы двойного назначения, продукции таких производителей как XILINX, Intel (ex.ALTERA), Vicor, Microchip, Texas Instruments, Analog Devices, Mini-Circuits, Amphenol, Glenair.

Сотрудничество с глобальными дистрибьюторами электронных компонентов, предоставляет возможность заказывать и получать с международных складов практически любой перечень компонентов в оптимальные для Вас сроки.

На всех этапах разработки и производства наши партнеры могут получить квалифицированную поддержку опытных инженеров.

Система менеджмента качества компании отвечает требованиям в соответствии с ГОСТ Р ИСО 9001, ГОСТ РВ 0015-002 и ЭС РД 009

### Офис по работе с юридическими лицами:

105318, г.Москва, ул.Щербаковская д.3, офис 1107, 1118, ДЦ «Щербаковский»

Телефон: +7 495 668-12-70 (многоканальный)

Факс: +7 495 668-12-70 (доб.304)

E-mail: [info@moschip.ru](mailto:info@moschip.ru)

Skype отдела продаж:

moschip.ru

moschip.ru\_4

moschip.ru\_6

moschip.ru\_9