

1.5A, 600V - 1000V Glass Passivated Bridge Rectifiers

FEATURES

- Glass passivated junction
- Ideal for automated placement
- Reliable low cost construction utilizing molded plastic technique
- High surge current capability
- Compliant to RoHS Directive 2011/65/EU and in accordance to WEEE 2002/96/EC
- Halogen-free according to IEC 61249-2-21



ABS

MECHANICAL DATA

Case: Molded plastic body

Molding compound, UL flammability classification rating 94V-0

Moisture sensitivity level: level 1, per J-STD-020

Part no. with suffix "H" means AEC-Q101 qualified

Packing code with suffix "G" means green compound (halogen-free)

Terminal: Matte tin plated leads, solderable per JESD22-B102

Meet JESD 201 class 2 whisker test

Polarity: Polarity as marked on the body

Weight: 0.096 g (approximately)

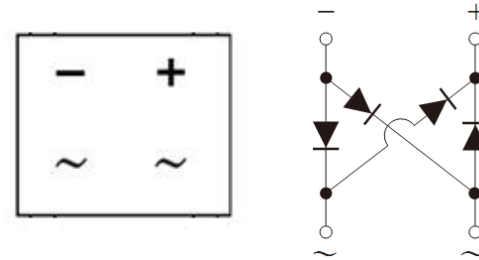

MAXIMUM RATINGS AND ELECTRICAL CHARACTERISTICS (T _A =25°C unless otherwise noted)						
PARAMETER	SYMBOL	ABS15J		ABS15M		Unit
Maximum repetitive peak reverse voltage	V _{RRM}	600		1000		V
Maximum RMS voltage	V _{RMS}	420		700		V
Maximum DC blocking voltage	V _{DC}	600		1000		V
Maximum average forward rectified current On glass-epoxy On aluminum substrate	I _{F(AV)}	1.5 2.0				A
Peak forward surge current, 8.3 ms single half sine-wave superimposed on rated load	I _{FSM}	40				A
Peak forward surge current, 1 ms single half sine-wave superimposed on rated load	I _{FSM}	100				A
Rating for fusing (t<8.3ms)	I ² t	6.64				A ² s
Maximum instantaneous forward voltage (Note 1) I _F = 0.5 A I _F = 1.5 A	V _F	TYP 0.88 0.97	MAX - 1.00	TYP 0.88 0.97	MAX - 1.00	V
Maximum reverse current @ rated V _R T _J =25°C T _J =125°C	I _R	5 150				μA
Typical thermal resistance	R _{θJL} R _{θJA}	25 80				°C/W
Operating junction temperature range	T _J	- 55 to +150				°C
Storage temperature range	T _{STG}	- 55 to +150				°C

Note 1: Pulse test with PW=300μs, 1% duty cycle

ORDERING INFORMATION

PART NO.	PART NO. SUFFIX	PACKING CODE	PACKING CODE SUFFIX	PACKAGE	PACKING
ABS15x (Note 1)	H	RE	G	ABS	1,000 / 7" Plastic reel
		RG		ABS	5,000 / 13" Paper reel

Note 1: "x" defines voltage from 600V (ABS15J) to 1000V (ABS15M)

Note 2: Whole series with green compound

EXAMPLE

PREFERRED P/N	PART NO.	PART NO. SUFFIX	PACKING CODE	PACKING CODE SUFFIX	DESCRIPTION
ABS15JHREG	ABS15J	H	RE	G	AEC-Q101 qualified Green compound

RATINGS AND CHARACTERISTICS CURVES

(T_A=25°C unless otherwise noted)

FIG.1 MAXIMUM FORWARD CURRENT DERATING CURVE



FIG. 2 TYPICAL REVERSE CHARACTERISTICS



FIG. 3 MAXIMUM NON-REPETITIVE FORWARD SURGE CURRENT



FIG. 4 TYPICAL JUNCTION CAPACITANCE



FIG. 5 TYPICAL FORWARD CHARACTERISTICS



PACKAGE OUTLINE DIMENSIONS

ABS



DIM.	Unit (mm)		Unit (inch)	
	Min	Max	Min	Max
B	4.30	4.50	0.169	0.177
C	6.25	6.65	0.246	0.262
D	0.60	0.70	0.024	0.028
E	3.90	4.10	0.154	0.161
F	4.90	5.10	0.193	0.200
G	1.40	1.60	0.055	0.063
H	1.35	1.45	0.053	0.057
I	0.05	0.15	0.002	0.006
J	0.30	0.70	0.012	0.028
K	0.15	0.25	0.006	0.010

SUGGESTED PAD LAYOUT



Symbol	Unit (mm)	Unit (inch)
A	1.50	0.059
B	0.90	0.035
C	4.22	0.166
D	7.22	0.284
E	2.05	0.081
F	5.72	0.225

MARKING DIAGRAM



P/N = Specific Device Code
YW = Date Code
F = Factory Code

Notice

Specifications of the products displayed herein are subject to change without notice. TSC or anyone on its behalf, assumes no responsibility or liability for any errors or inaccuracies.

Information contained herein is intended to provide a product description only. No license, express or implied, to any intellectual property rights is granted by this document. Except as provided in TSC's terms and conditions of sale for such products, TSC assumes no liability whatsoever, and disclaims any express or implied warranty, relating to sale and/or use of TSC products including liability or warranties relating to fitness for a particular purpose, merchantability, or infringement of any patent, copyright, or other intellectual property right.

The products shown herein are not designed for use in medical, life-saving, or life-sustaining applications. Customers using or selling these products for use in such applications do so at their own risk and agree to fully indemnify TSC for any damages resulting from such improper use or sale.

Данный компонент на территории Российской Федерации

Вы можете приобрести в компании MosChip.

Для оперативного оформления запроса Вам необходимо перейти по данной ссылке:

<http://moschip.ru/get-element>

Вы можете разместить у нас заказ для любого Вашего проекта, будь то серийное производство или разработка единичного прибора.

В нашем ассортименте представлены ведущие мировые производители активных и пассивных электронных компонентов.

Нашей специализацией является поставка электронной компонентной базы двойного назначения, продукции таких производителей как XILINX, Intel (ex.ALTERA), Vicor, Microchip, Texas Instruments, Analog Devices, Mini-Circuits, Amphenol, Glenair.

Сотрудничество с глобальными дистрибьюторами электронных компонентов, предоставляет возможность заказывать и получать с международных складов практически любой перечень компонентов в оптимальные для Вас сроки.

На всех этапах разработки и производства наши партнеры могут получить квалифицированную поддержку опытных инженеров.

Система менеджмента качества компании отвечает требованиям в соответствии с ГОСТ Р ИСО 9001, ГОСТ РВ 0015-002 и ЭС РД 009

Офис по работе с юридическими лицами:

105318, г.Москва, ул.Щербаковская д.3, офис 1107, 1118, ДЦ «Щербаковский»

Телефон: +7 495 668-12-70 (многоканальный)

Факс: +7 495 668-12-70 (доб.304)

E-mail: info@moschip.ru

Skype отдела продаж:

moschip.ru

moschip.ru_4

moschip.ru_6

moschip.ru_9