

**RoHS SIDACTor® Balanced Series - MS-013**

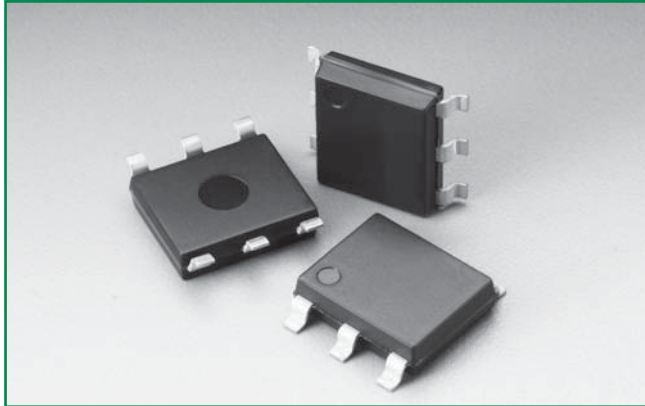

**Description**

The SIDACTor® Balanced Series MS-013 are designed to protect baseband equipment from overvoltage transients. The patented "Y" configuration ensures balanced overvoltage protection.

The series provides a single port surface mount solution that enables voice through DS-1 equipment to comply with various global regulatory standards.

**Features and Benefits**

- Balanced overvoltage protection
- Low voltage overshoot
- Low on-state voltage
- Does not degrade with use
- Fails short circuit when surged in excess of ratings
- Replaces three discrete devices
- Meets UL/IEC 60950-1 creepage and clearance

**Agency Approvals**

Agency	Agency File Number
	E133083

**Pinout Designation**

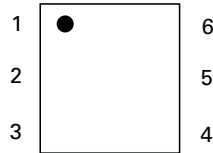

**Schematic Symbol**

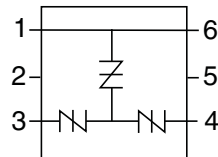

**Applicable Global Standards**

- TIA-968-A
- TIA-968-B
- ITU K.20/21 Enhanced Level
- ITU K.20/21 Basic Level
- GR 1089 Intra-building
- IEC 61000-4-5
- YD/T 1082
- YD/T 993
- YD/T 950
- GR 1089 Inter-building

**Electrical Characteristics**

Part Number	Part Marking	$V_{DRM}$ @ $I_{DRM}=5\mu A$	$V_S$ @ 100V/ $\mu s$	$V_{DRM}$ @ $I_{DRM}=5\mu A$	$V_S$ @ 100V/ $\mu s$	$V_T$	$I_S$	$I_T$	$I_H$	Capacitance
		V min	V max	V min	V max	V max	mA max	A max	mA min	
		Pins 1 & 6-3, 1 & 6-4		Pins 3-4						
P1553UALxx	P1553UA	130	180	130	180	8	800	2.2	150	See Capacitance Values table
P1803UALxx	P1803UA	150	210	150	210	8	800	2.2	150	
P2103UALxx	P2103UA	170	250	170	250	8	800	2.2	150	
P2353UALxx	P2353UA	200	270	200	270	8	800	2.2	150	
P2703UALxx	P2703UA	230	300	230	300	8	800	2.2	150	
P3203UALxx	P3203UA	270	350	270	350	8	800	2.2	150	
P3403UALxx	P3403UA	300	400	300	400	8	800	2.2	150	
P5103UALxx	P5103UA	420	600	420	600	8	800	2.2	150	

Table continues on next page.

Notes:  
 - Absolute maximum ratings measured at  $T_A = +25^\circ C$  (unless otherwise noted).  
 - Devices are bi-directional.  
 - **XX** = Part Number Suffix: 'TP' (Tube Pack) or 'RP' (Reel Pack).  
 © 2011 Littelfuse, Inc.  
 Specifications are subject to change without notice.  
 Please refer to [www.littelfuse.com](http://www.littelfuse.com) for current information.

**Electrical Characteristics (continued)**

Part Number	Part Marking	$V_{DRM}$ @ $I_{DRM}=5\mu A$	$V_S$ @ 100V/ $\mu s$	$V_{DRM}$ @ $I_{DRM}=5\mu A$	$V_S$ @ 100V/ $\mu s$	$V_T$	$I_S$	$I_T$	$I_H$	Capacitance
		V min	V max	V min	V max	V max	mA max	A max	mA min	
		Pins 1 & 6-3, 1 & 6-4		Pins 3-4						
P1553UBLxx	P1553UB	130	180	130	180	8	800	2.2	150	See Capacitance Values table
P1803UBLxx	P1803UB	150	210	150	210	8	800	2.2	150	
P2103UBLxx	P2103UB	170	250	170	250	8	800	2.2	150	
P2353UBLxx	P2353UB	200	270	200	270	8	800	2.2	150	
P2703UBLxx	P2703UB	230	300	230	300	8	800	2.2	150	
P3203UBLxx	P3203UB	270	350	270	350	8	800	2.2	150	
P3403UBLxx	P3403UB	300	400	300	400	8	800	2.2	150	
P5103UBLxx	P5103UB	420	600	420	600	8	800	2.2	150	
P1553UCLxx	P1553UC	130	180	130	180	8	800	2.2	150	
P1803UCLxx	P1803UC	150	210	150	210	8	800	2.2	150	
P2103UCLxx	P2103UC	170	250	170	250	8	800	2.2	150	
P2353UCLxx	P2353UC	200	270	200	270	8	800	2.2	150	
P2703UCLxx	P2703UC	230	300	230	300	8	800	2.2	150	
P3203UCLxx	P3203UC	270	350	270	350	8	800	2.2	150	
P3403UCLxx	P3403UC	300	400	300	400	8	800	2.2	150	
P5103UCLxx	P5103UC	420	600	420	600	8	800	2.2	150	

**Capacitance Values**

Part Number	Pin 3-4 Tip-Ring		Pins 1 & 6-3, 1 & 6-4 Tip-Ground, Ring-Ground	
	pF min	pF max	pF min	pF max
P1553UALxx	20	95	10	60
P1803UALxx	20	85	10	55
P2103UALxx	15	85	10	55
P2353UALxx	15	75	10	50
P2703UALxx	15	75	10	50
P3203UALxx	15	70	10	45
P3403UALxx	15	65	10	45
P5103UALxx	10	60	10	40
P1553UBLxx	25	95	15	60
P1803UBLxx	25	85	15	55
P2103UBLxx	20	85	15	55
P2353UBLxx	20	75	15	50
P2703UBLxx	20	75	10	50
P3203UBLxx	20	70	10	45
P3403UBLxx	15	65	10	45
P5103UBLxx	15	60	10	40
P1553UCLxx	30	95	20	60
P1803UCLxx	30	85	15	55
P2103UCLxx	30	85	15	55
P2353UCLxx	25	75	15	50
P2703UCLxx	25	75	15	50
P3203UCLxx	25	70	15	45
P3403UCLxx	20	65	15	45
P5103UCLxx	20	60	10	40

Note: Off-state capacitance ( $C_o$ ) is measured at 1 MHz with a 2 V bias.

**Surge Ratings**

Series	$I_{PP}$										$I_{TSM}$ 50/60 Hz	di/dt
	0.2x310 <sup>1</sup> 0.5x700 <sup>2</sup>	2x10 <sup>1</sup> 2x10 <sup>2</sup>	8x20 <sup>1</sup> 1.2x50 <sup>2</sup>	10x160 <sup>1</sup> 10x160 <sup>2</sup>	10x560 <sup>1</sup> 10x560 <sup>2</sup>	5x320 <sup>1</sup> 9x720 <sup>2</sup>	10x360 <sup>1</sup> 10x360 <sup>2</sup>	10x1000 <sup>1</sup> 10x1000 <sup>2</sup>	5x310 <sup>1</sup> 10x700 <sup>2</sup>			
	A min	A min	A min	A min	A min	A min	A min	A min	A min	A min		
A	20	150	150	90	50	75	75	45	75	20	500	
B	25	250	250	150	100	100	125	80	100	25	500	
C	50	500	400	200	150	200	175	100	200	50	500	

Notes:  
 1 Current waveform in  $\mu$ s  
 2 Voltage waveform in  $\mu$ s  
 - Peak pulse current rating ( $I_{pp}$ ) is repetitive and guaranteed for the life of the product.  
 -  $I_{pp}$  ratings applicable over temperature range of -40 to +85°C  
 - The device must initially be in thermal equilibrium with -40°C  $\leq$  T<sub>j</sub>  $\leq$  +150°C

**Thermal Considerations**

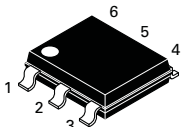
Package	Symbol	Parameter	Value	Unit
Modified MS-013 	T <sub>J</sub>	Operating Junction Temperature Range	-40 to +150	°C
	T <sub>S</sub>	Storage Temperature Range	-65 to +150	°C
	R <sub>θJA</sub>	Thermal Resistance: Junction to Ambient	60	°C/W

**V-I Characteristics**

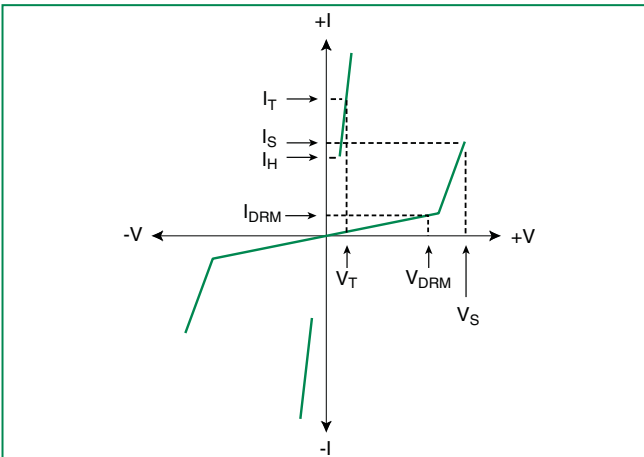

**t<sub>r</sub> x t<sub>d</sub> Pulse Waveform**

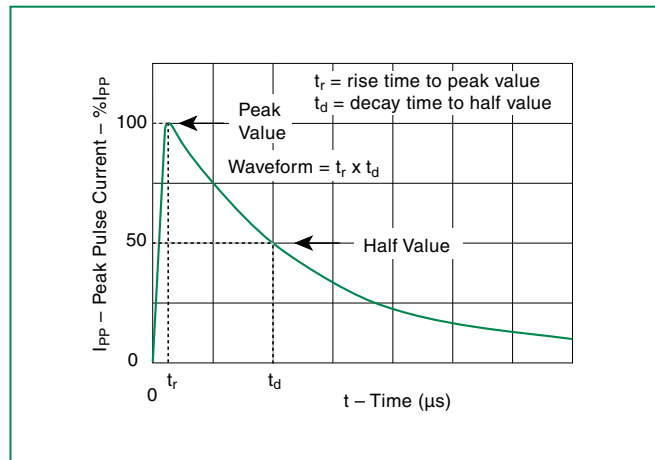

**Normalized V<sub>S</sub> Change vs. Junction Temperature**

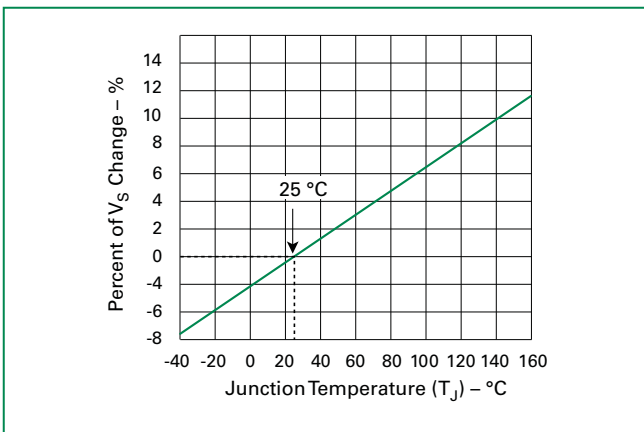

**Normalized DC Holding Current vs. Case Temperature**

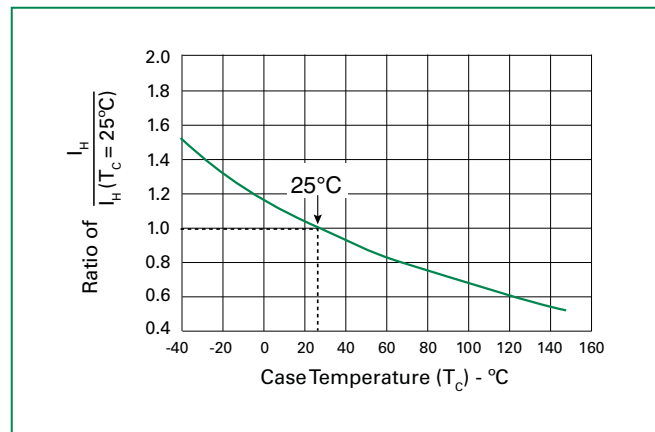

**Soldering Parameters**

Reflow Condition	Pb-Free assembly (see Fig. 1)	
Pre Heat	-Temperature Min ( $T_{s(min)}$ )	+150°C
	-Temperature Max ( $T_{s(max)}$ )	+200°C
	-Time (Min to Max) ( $t_s$ )	60-180 secs.
Average ramp up rate (Liquidus Temp ( $T_L$ ) to peak)	3°C/sec. Max.	
$T_{s(max)}$ to $T_L$ - Ramp-up Rate	3°C/sec. Max.	
Reflow	-Temperature ( $T_L$ ) (Liquidus)	+217°C
	-Temperature ( $t_L$ )	60-150 secs.
Peak Temp ( $T_p$ )	+260(+0/-5)°C	
Time within 5°C of actual Peak Temp ( $t_p$ )	30 secs. Max.	
Ramp-down Rate	6°C/sec. Max.	
Time 25°C to Peak Temp ( $T_p$ )	8 min. Max.	
Do not exceed	+260°C	

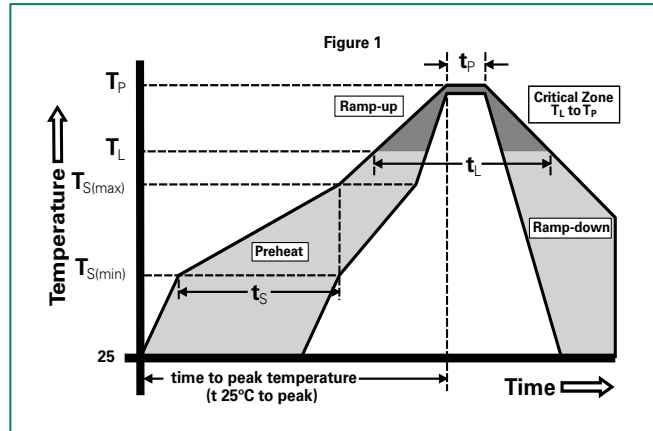

**Physical Specifications**

<b>Lead Material</b>	Copper Alloy
<b>Terminal Finish</b>	100% Matte-Tin Plated
<b>Body Material</b>	UL recognized epoxy meeting flammability classification 94V-0

**Part Marking**

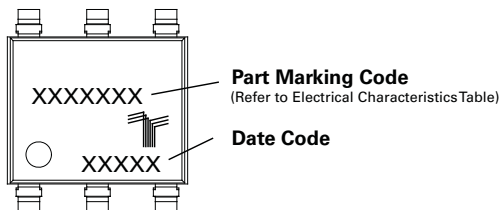

**Part Numbering**

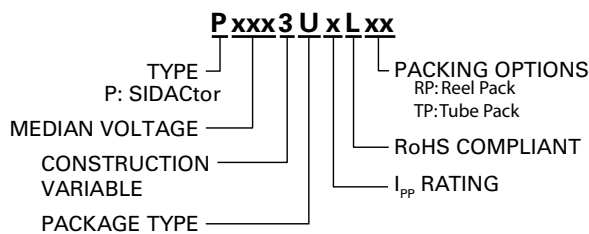

**Environmental Specifications**

<b>High Temp Voltage Blocking</b>	80% Rated $V_{DRM}$ ( $V_{AC}$ Peak) +125°C or +150°C, 504 or 1008 hrs. MIL-STD-750 (Method 1040) JEDEC, JESD22-A-101
<b>Temp Cycling</b>	-65°C to +150°C, 15 min. dwell, 10 up to 100 cycles. MIL-STD-750 (Method 1051) EIA/JEDEC, JESD22-A-104
<b>Biased Temp &amp; Humidity</b>	52 $V_{DC}$ (+85°C) 85%RH, 504 up to 1008 hrs. EIA/JEDEC, JESD22-A-101
<b>High Temp Storage</b>	+150°C 1008 hrs. MIL-STD-750 (Method 1031) JEDEC, JESD22-A-101
<b>Low Temp Storage</b>	-65°C, 1008 hrs.
<b>Thermal Shock</b>	0°C to +100°C, 5 min. dwell, 10 sec. transfer, 10 cycles. MIL-STD-750 (Method 1056) JEDEC, JESD22-A-106
<b>Autoclave (Pressure Cooker Test)</b>	+121°C, 100%RH, 2atm, 24 up to 168 hrs. EIA/JEDEC, JESD22-A-102
<b>Resistance to Solder Heat</b>	+260°C, 30 secs. MIL-STD-750 (Method 2031)
<b>Moisture Sensitivity Level</b>	85%RH, +85°C, 168 hrs., 3 reflow cycles (+260°C Peak). JEDEC-J-STD-020, Level 1

**Packing Options**

Package Type	Description	Quantity	Added Suffix	Industry Standard
U	Modified MS-013 6-pin Tape and Reel Pack	1500	RP	EIA-481-D
	Modified MS-013 6-pin Tube Pack	500 (50 per tube)	TP	N/A

**Dimensions — MS-013**

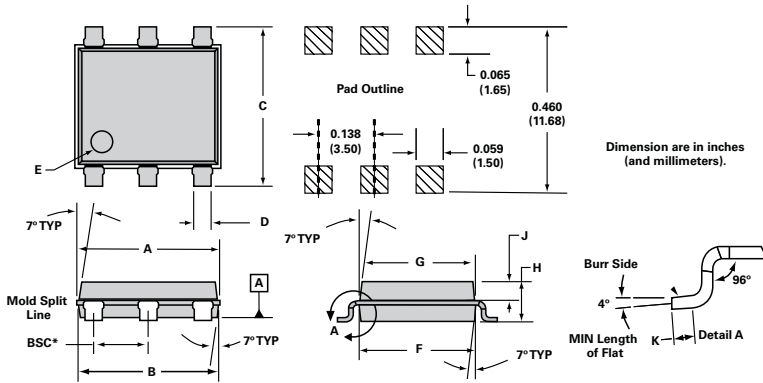

Dimensions	Inches		Millimeters	
	Min	Max	Min	Max
<b>A</b>	0.360	0.364	9.14	9.25
<b>B</b>	0.352	0.356	8.94	9.04
<b>C</b>	0.400	0.412	10.16	10.46
<b>D</b>	0.043	0.045	1.09	1.13
<b>E</b>	0.047	0.055	1.19	1.40
<b>F</b>	0.293	0.297	7.44	7.54
<b>G</b>	0.289	0.293	7.34	7.44
<b>H</b>	0.089	0.093	2.26	2.36
<b>J</b>	0.041	0.049	1.04	1.24
<b>K</b>	0.020		0.51	
<b>BSC*</b>	0.133	0.143	3.38	3.63

\* BSC = Basic Spacing between Centers

**Tape and Reel Specification — MS-013**

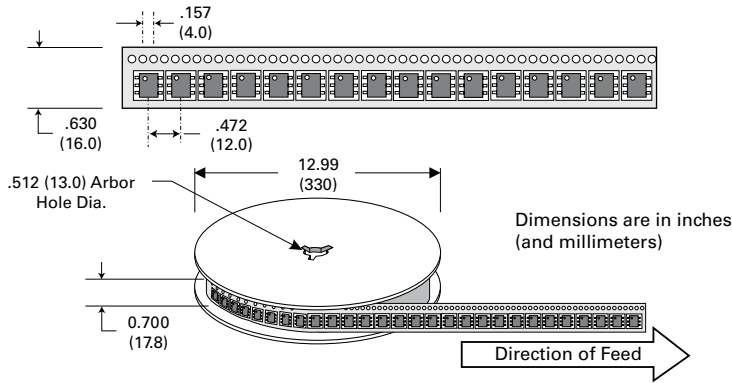

**Tube Pack Specification — MS-013**

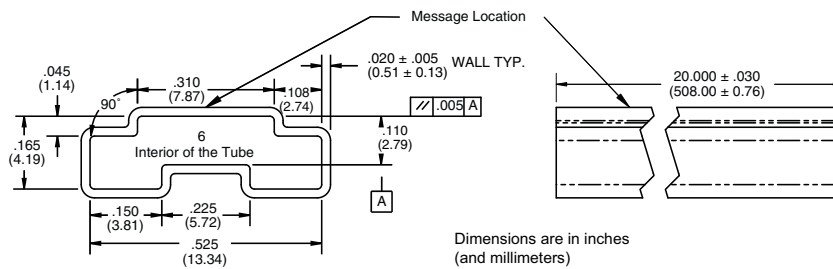

## Данный компонент на территории Российской Федерации

### Вы можете приобрести в компании MosChip.

Для оперативного оформления запроса Вам необходимо перейти по данной ссылке:

<http://moschip.ru/get-element>

Вы можете разместить у нас заказ для любого Вашего проекта, будь то серийное производство или разработка единичного прибора.

В нашем ассортименте представлены ведущие мировые производители активных и пассивных электронных компонентов.

Нашей специализацией является поставка электронной компонентной базы двойного назначения, продукции таких производителей как XILINX, Intel (ex.ALTERA), Vicor, Microchip, Texas Instruments, Analog Devices, Mini-Circuits, Amphenol, Glenair.

Сотрудничество с глобальными дистрибьюторами электронных компонентов, предоставляет возможность заказывать и получать с международных складов практически любой перечень компонентов в оптимальные для Вас сроки.

На всех этапах разработки и производства наши партнеры могут получить квалифицированную поддержку опытных инженеров.

Система менеджмента качества компании отвечает требованиям в соответствии с ГОСТ Р ИСО 9001, ГОСТ РВ 0015-002 и ЭС РД 009

### Офис по работе с юридическими лицами:

105318, г.Москва, ул.Щербаковская д.3, офис 1107, 1118, ДЦ «Щербаковский»

Телефон: +7 495 668-12-70 (многоканальный)

Факс: +7 495 668-12-70 (доб.304)

E-mail: [info@moschip.ru](mailto:info@moschip.ru)

Skype отдела продаж:

moschip.ru

moschip.ru\_4

moschip.ru\_6

moschip.ru\_9