

NEW

6GHz-compatible antenna connector

GT16G Series

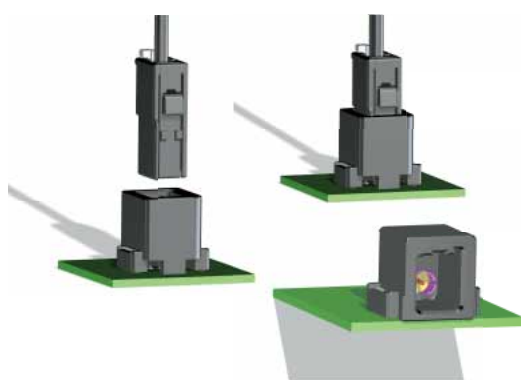

■ Features

- **Superior high frequency performance :**
V.S.W.R. is 1.5 in max (DC to 6GHz)
- **Satisfies rigorous test conditions for automotive devices**
- **Robust lock design provides a tactile click**
• Lock strength : 98N min
- **Many variations**
 - PCB connectors
SMT type, mid-mount type, lead reflow type
 - In-line connectors
Retainer-less type, Retainer type, bracket type, water-proof type
- **RoHS compliant**
- ◆ **Applications :**
Automotive WiFi/Bluetooth, V2X, DSRC, etc.

■ High frequency performance

- **V.S.W.R. maximum of 1.5 under all frequencies in a range between DC and 6GHz, presenting a superior high frequency performance.**
- **Available as connectors for automotive ETC, automotive WiFi/Bluetooth.**

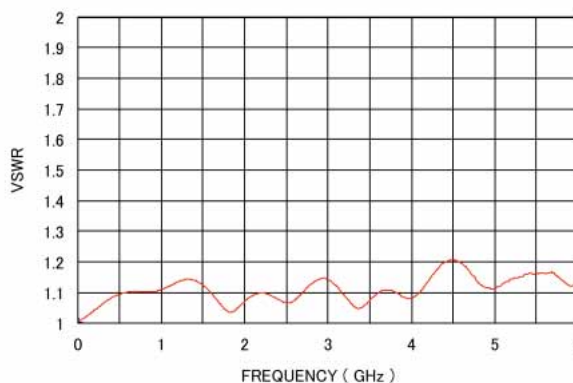

*Data taken based on GT16GH-1P-DSA and GT16G-1S-HU (24).

■ Product Specifications

Ratings	Rated current : 1A	Rated voltage : 250V AC
	Operating temperature range : -30°C to 105°C	Storage temperature range : -40°C to 105°C
Items	Specifications	Conditions
1. Insulation resistance	A min of 100MΩ	Measured at 500V DC
2. Withstanding voltage	No flashover or dielectric breakdown.	650V AC for 1 minute
3. Contact resistance	Center contact : 30mΩ max, Outer contact : 60mΩ max	Measured at 1A DC
4. High frequency	V.S.W.R. : 1.5 max	Measured in a range between 0 and 6GHz, Characteristic impedance : 50Ω
5. Heat resistance	Center contact : 60mΩ max, Outer contact : 120mΩ max	105°C for 300 hours
6. Low temperature resistance	Center contact : 60mΩ max, Outer contact : 120mΩ max	-40°C for 120 hours
7. Vibration resistance	No electrical discontinuity over 10μs.	20 to 200Hz, acceleration : 43.1m/s ² , 3 axial directions, 3 hours
8. Humidity resistance	Insulation resistance : 100MΩ min	60°C, humidity : 90 to 95%, 96 hours
9. Temperature cycles	Center contact : 60mΩ max, Outer contact : 120mΩ max No damage, cracks or loosened parts.	Temperature -40°C → Room temperature → 105°C → Room temperature, 30 minutes → 5 minutes → 30 minutes → 5 minutes, 1000 cycles
10. Mating durability	Center contact : 60mΩ max, Outer contact : 120mΩ max	30 mating cycles
11. Soldering heat resistance	No deformation or excessive looseness of the terminals.	• Reflow : Twice with specified temperature profile. • Soldering iron temperature : 350°C, Max10sec.

In cases where the application will demand a high level of reliability, such as automotive, please contact a company representative for further information.

Product Number Structure

Refer to the chart below when determining the product specifications from the product number.
Please select from the product numbers listed in this catalog when placing orders.

● PCB connector/Inline connector

GT 16G * - 1 P - H

① ② ③ ④ ⑤ ⑥

① Series name : GT	⑤ Contact type PCB connector P : Pin header Inline connector S : Socket P : Inline plug PP : Inline plug with bracket P/S : Available for both male and female
② Series No. : 16C, 16G, 5W	
③ Series Sub No. : Serial No.	
④ Number of signal contacts : 1	
⑥ Product type PCB connector H : Right angle DSA : Straight Inline connector HU : Housing R : Retainer	

● Center connector/outer connector

GT 16G * - 2428 SCF

① ② ③ ④ ⑤

① Series name : GT	⑤ Form/Packaging Center SCF : Socket crimp contact/reel PCF : Plug crimp contact/reel Outer SC : Socket crimp contact/piece PC : Plug crimp contact/piece
② Series No. : 16G	
③ Series Sub No. : Serial No.	
④ Applicable wire size Center 2428 : 24 to 28AWG Outer /1.6-2.9 : 1.5D-2W or equivalent	

● Insulator/contact ferrule/outer ferrule

GT 16G - SC

① ② ③

① Series name : GT	③ Part name SC : Female insulator PC : Male insulator FR : Contact ferrule 1.5DHQS : Outer Ferrule
② Series No. : 16G	

GT16G Series Mating Table

Female Connector	Male Connector	
GT16GM-1S-ASSY (Retainer-less type)	SMT type	GT16GMP-1P-H
	PCB mid-mount type	GT16GM-1P-H
	Inline type	GT16GM-1P-ASSY
	Inline bracket type	GT16GMN-1PP-ASSY
GT16G-1S-ASSY GT16GT-1S-ASSY (Retainer type)	SMT type	GT16GD-1P-H
		GT16GT-1P-H
		GT16GH-1P-H
	PCB mid-mount type	GT16G-1P-H
		GT16GL-1P-H(71)D
		GT16GRL-1P-H
Lead reflow type	GT16GH-1P-DSA	
	GT16GT-1PP-ASSY	
GT16GW-1S-ASSY	Water-proof inline type	GT16GW-1P-ASSY

■ Harness connector

● GT16GM-1S-ASSY

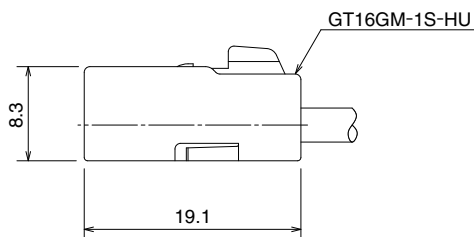

*Use two insulators per termination.

■ Housing / insulator

Part	Housing	Insulator
Part No.	GT16GM-1S-HU	GT16G-SC
HRS No.	766-0033-9	766-0023-5
Materials	PBT	PBT
Color	Black	Natural
Sales unit	1 piece	1 piece
RoHS	○	○
Dimension		

■ Center contact / outer contact

Part	Center contact	Outer contact
Part No.	GT16G-2428SCF	GT16GM-1.6-2.9SC
HRS No.	766-0022-2	766-0025-0
Materials	Phosphor bronze	Phosphor bronze
Finish	Tin plating	Tin plating
Applicable wire size	24 to 28 AWG	1.5D-2W or equivalent
Sales unit	10,000 pcs/reel	1 piece
RoHS	○	○
Dimension		

■ Contact ferrule / outer ferrule

Part	Contact ferrule	Outer ferrule
Part No.	GT16G-FR	GT16G-1.5DHQS
HRS No.	766-0028-9	766-0027-6
Materials	Phosphor bronze	Phosphor bronze
Finish	Tin plating	Tin plating
Sales unit	1 piece	1 piece
RoHS	○	○
Dimension		

●GT16GM-1P-ASSY



●GT16GMN-1PP-ASSY

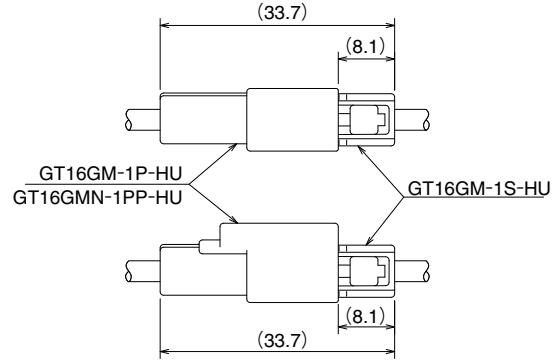

*Use two insulators per termination.

■Housing / insulator

Part	Housing		Insulator
Part No.	GT16GM-1P-HU	GT16GMN-1PP-HU	GT16G-PC
HRS No.	766-0050-8	766-0051-0	766-0047-3
Materials	PBT	PBT	PBT
Color	Black	Black	Natural
Sales unit	1 piece	1 piece	1 piece
RoHS	○	○	○
Dimension			

■Center contact / outer contact

Part	Center contact	Outer contact
Part No.	GT16G-2428PCF	GT16G-1.6-2.9PC
HRS No.	766-0046-0	766-0048-6
Materials	Brass	Phosphor bronze
Finish	Tin plating	Tin plating
Applicable wire size	24 to 28 AWG	1.5D-2W or equivalent
Sales unit	10,000 pcs/reel	1 piece
RoHS	○	○
Dimension		

■Contact ferrule / outer ferrule

Part	Contact ferrule	Outer ferrule
Part No.	GT16G-FR	GT16G-1.5DHQS
HRS No.	766-0028-9	766-0027-6
Materials	Phosphor bronze	Phosphor bronze
Finish	Tin plating	Tin plating
Sales unit	1 piece	1 piece
RoHS	○	○
Dimension		

Dec.1.2018 Copyright 2018 HIROSE ELECTRIC CO., LTD. All Rights Reserved.

●GT16G-1S-ASSY

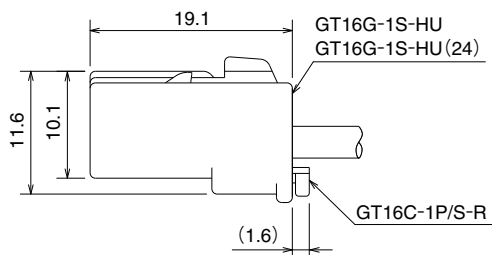

*Use two insulators per termination.

■Housing / insulator / Retainer

Part	Housing		Insulator	Retainer
Part No.	GT16G-1S-HU	GT16G-1S-HU(24)	GT16G-SC	GT16C-1P/S-R
HRS No.	766-0026-3	766-0026-3 24	766-0023-5	766-0011-6
Materials	PBT	PBT	PBT	PBT
Color	Light gray	Black	Natural	Dark gray
Sales unit	1 piece	1 piece	1 piece	1 piece
RoHS	○	○	○	○
Dimension				

■Center contact / outer contact

Part	Center contact	Outer contact
Part No.	GT16G-2428SCF	GT16G-1.6-2.9SC
HRS No.	766-0022-2	766-0024-8
Materials	Phosphor bronze	Phosphor bronze
Finish	Tin plating	Tin plating
Applicable wire size	24 to 28 AWG	1.5D-2W or equivalent
Sales unit	10,000 pcs/reel	1 piece
RoHS	○	○
Dimension		

■Contact ferrule / outer ferrule

Part	Contact ferrule	Outer ferrule
Part No.	GT16G-FR	GT16G-1.5DHQS
HRS No.	766-0028-9	766-0027-6
Materials	Phosphor bronze	Phosphor bronze
Finish	Tin plating	Tin plating
Sales unit	1 piece	1 piece
RoHS	○	○
Dimension		

●GT16GT-1S-ASSY

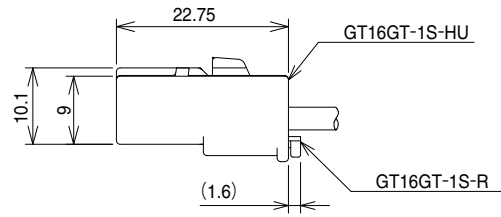

*Use two insulators per termination.

■Housing / insulator / Retainer

Part	Housing	Insulator	Retainer
Part No.	GT16GT-1S-HU	GT16G-SC	GT16GT-1S-R
HRS No.	766-0098-4	766-0023-5	766-0099-7
Materials	PBT	PBT	PBT
Color	Black	Natural	Natural
Sales unit	1 piece	1 piece	1 piece
RoHS	○	○	○
Dimension			

■Center contact / outer contact

Part	Center contact	Outer contact
Part No.	GT16G-2428SCF	GT16G-1.6-2.9SC
HRS No.	766-0022-2	766-0024-8
Materials	Phosphor bronze	Phosphor bronze
Finish	Tin plating	Tin plating
Applicable wire size	24 to 28 AWG	1.5D-2W or equivalent
Sales unit	10,000 pcs/reel	1 piece
RoHS	○	○
Dimension		

■Contact ferrule / outer ferrule

Part	Contact ferrule	Outer ferrule
Part No.	GT16G-FR	GT16G-1.5DHQS
HRS No.	766-0028-9	766-0027-6
Materials	Phosphor bronze	Phosphor bronze
Finish	Tin plating	Tin plating
Sales unit	1 piece	1 piece
RoHS	○	○
Dimension		

●GT16GT-1PP-ASSY

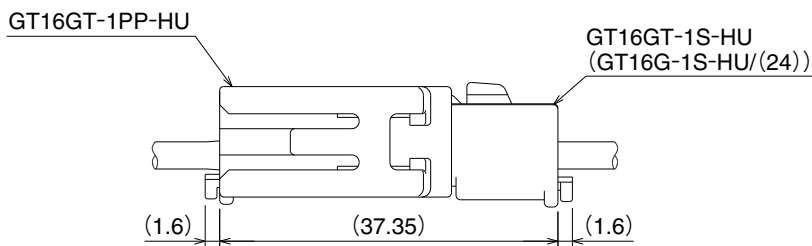

*Use two insulators per termination.

■Housing / insulator / Retainer

Part	Housing	Insulator	Retainer
Part No.	GT16GT-1PP-HU	GT16G-PC	GT16C-1R/S-R
HRS No.	766-0049-9	766-0047-3	766-0011-6
Materials	PBT	PBT	PBT
Color	Black	Natural	Dark gray
Sales unit	1 piece	1 piece	1 piece
RoHS	○	○	○
Dimension			

■Center contact / outer contact

Part	Center contact	Outer contact
Part No.	GT16G-2428PCF	GT16G-1.6-2.9PC
HRS No.	766-0046-0	766-0048-6
Materials	Brass	Phosphor bronze
Finish	Tin plating	Tin plating
Applicable wire size	24 to 28 AWG	1.5D-2W or equivalent
Sales unit	10,000 pcs/reel	1 piece
RoHS	○	○
Dimension		

■Contact ferrule / outer ferrule

Part	Contact ferrule	Outer ferrule
Part No.	GT16G-FR	GT16G-1.5DHQS
HRS No.	766-0028-9	766-0027-6
Materials	Phosphor bronze	Phosphor bronze
Finish	Tin plating	Tin plating
Sales unit	1 piece	1 piece
RoHS	○	○
Dimension		

●GT16GW-1P-ASSY

●GT16GW-1S-ASSY

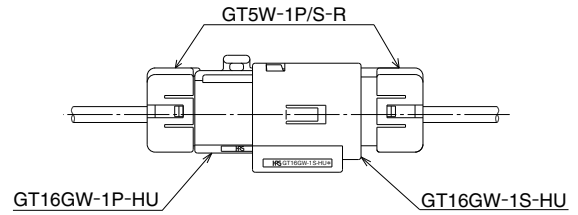

*Use two insulators per termination.

■Housing / insulator / Retainer

Part	Housing		Insulator		Retainer
Part No.	GT16GW-1P-HU	GT16GW-1S-HU	GT16G-PC	GT16G-SC	GT5W-1P/S-R
HRS No.	766-0077-4	766-0076-1	766-0047-3	766-0023-5	755-0028-5
Materials	PBT	PBT/Silicone rubber	PBT	PBT	PBT/Silicone rubber
Color	Black	Black/white	Natural	Natural	Dark gray/light blue
Sales unit	1 piece	1 piece	1 piece	1 piece	1 piece
RoHS	○	○	○	○	○
Dimension					

■Center contact / outer contact

Part	Center contact		Outer contact	
Part No.	GT16G-2428PCF	GT16G-2428SCF	GT16G-/1.6-2.9PC	GT16G-/1.6-2.9SC
HRS No.	766-0046-0	766-0022-2	766-0048-6	766-0024-8
Materials	Brass	Phosphor bronze	Phosphor bronze	Phosphor bronze
Finish	Tin plating	Tin plating	Tin plating	Tin plating
Applicable wire size	24 to 28 AWG	24 to 28 AWG	1.5D-2W or equivalent	1.5D-2W or equivalent
Sales unit	10,000 pcs/reel	10,000 pcs/reel	1 piece	1 piece
RoHS	○	○	○	○
Dimension				

■Contact ferrule / outer ferrule

Part	Contact ferrule	Outer ferrule
Part No.	GT16G-FR	GT16G-1.5DHQS
HRS No.	766-0028-9	766-0027-6
Materials	Phosphor bronze	Phosphor bronze
Finish	Tin plating	Tin plating
Sales unit	1 piece	1 piece
RoHS	○	○
Dimension		

Dec.1.2018 Copyright 2018 HIROSE ELECTRIC CO., LTD. All Rights Reserved.

PCB connector

● SMT type (onboard)

◆ GT16GMP-1P-H



Dimension

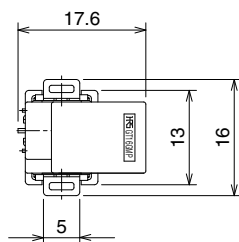

Recommended panel dimension

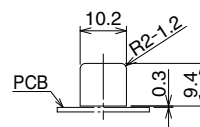

Recommended PCB Layout

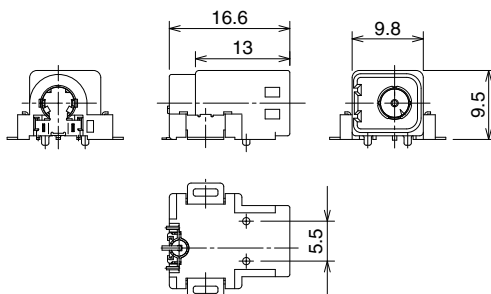
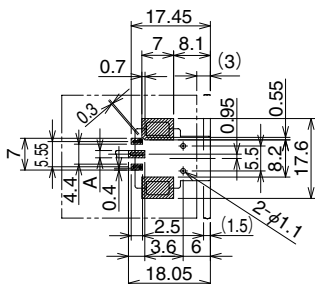

Mated condition

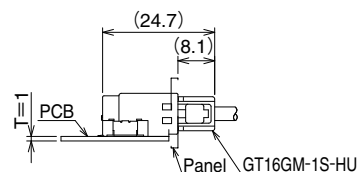

Note : Adjust size A of a microstrip line to satisfy 50Ω characteristic impedance.

Part No.	HRS No.	Part	Materials	Finish or color	Sales unit	RoHS
GT16GMP-1P-H	766-0052-3	Housing	PPS	Black	200 pcs/reel	○
		Center terminal	Phosphor bronze	Tin plating		
		Outer terminal	Phosphor bronze	Tin plating		
		Insulator L and R	PPS	Natural		
		Shielding plate	Phosphor bronze	Tin plating		
		Metal peg	Brass	Tin plating		

◆ GT16GD-1P-H



Dimension

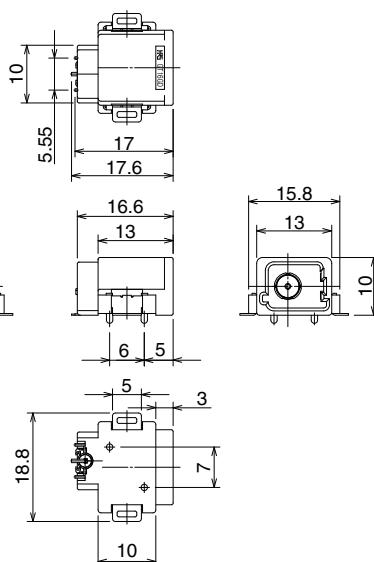

Recommended panel dimension

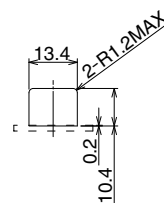

Recommended PCB Layout

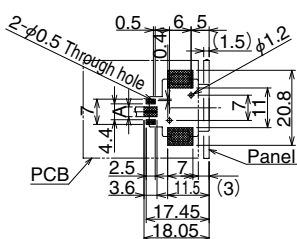

Mated condition

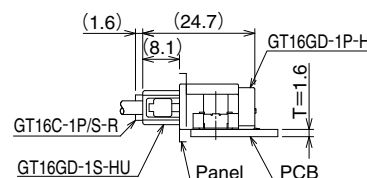

Note : Adjust size A of a microstrip line to satisfy 50Ω characteristic impedance.

Part No.	HRS No.	Part	Materials	Finish or color	Sales unit	RoHS
GT16GD-1P-H	766-0044-5	Housing	PPS	Black	200 pcs/reel	○
		Center terminal	Phosphor bronze	Tin plating		
		Outer terminal	Phosphor bronze	Tin plating		
		Insulator L and R	PPS	Natural		
		Shielding plate	Phosphor bronze	Tin plating		
		Metal peg	Brass	Tin plating		

● SMT type (mid-mount)

◆ GT16GM-1P-H (Metal peg : Lock pin type)



◆ Dimension

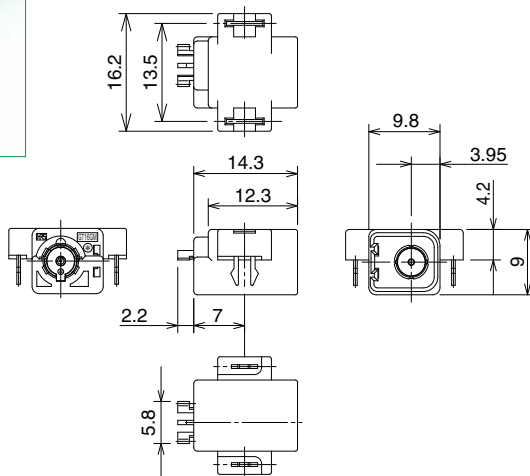

◆ Recommended panel dimension

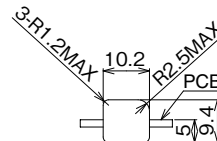

◆ Recommended PCB Layout

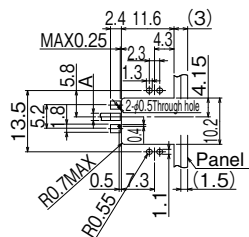

◆ Mated condition

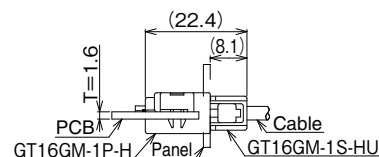

Note : Adjust size A of a microstrip line to satisfy 50Ω characteristic impedance.

Part No.	HRS No.	Part	Materials	Finish or color	Sales unit	RoHS
GT16GM-1P-H	766-0032-6	Housing	PBT	Black	1 piece	○
		Center terminal	Phosphor bronze	Tin plating		
		Outer terminal	Phosphor bronze	Tin plating		
		Insulator	PBT	Natural		
		Lock pin	Phosphor bronze	Tin plating		

◆ GT16G-1P-H (Screw type)



◆ Dimension

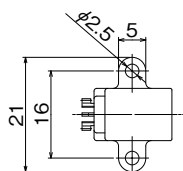

◆ Recommended panel dimension

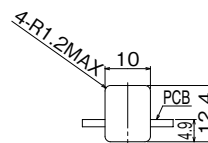

◆ Recommended PCB Layout

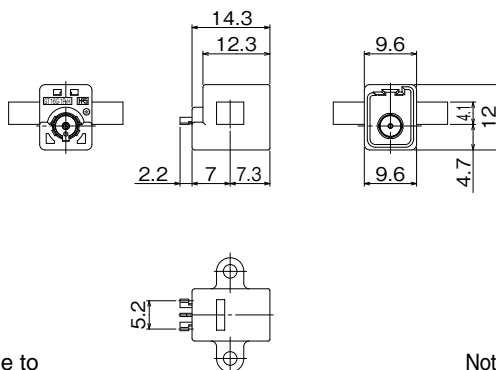
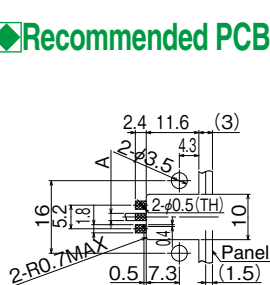

◆ Mated condition

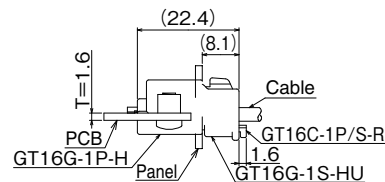

Note : Adjust size A of a microstrip line to satisfy 50Ω characteristic impedance.

Note : Use JIS B 1122 pan tapping screws (Type 2, Nominal diameter : 3mm, Length : 6mm).

Part No.	HRS No.	Part	Materials	Finish or color	Sales unit	RoHS
GT16G-1P-H	766-0021-0	Housing	PBT	Light gray	1 piece	○
		Center terminal	Phosphor bronze	Tin plating		
		Outer terminal	Phosphor bronze	Tin plating		
		Insulator	PBT	Natural		

◆GT16GL-1P-H (71) D (Metal peg : Lead reflow type)



◆Dimension

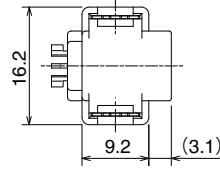

◆Recommended panel dimension

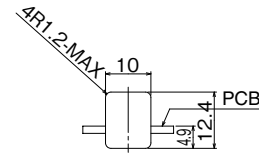

◆Recommended PCB Layout

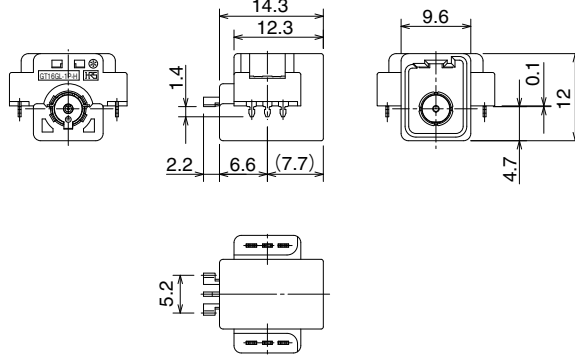
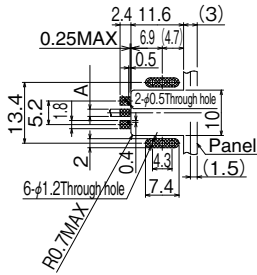

◆Mated condition

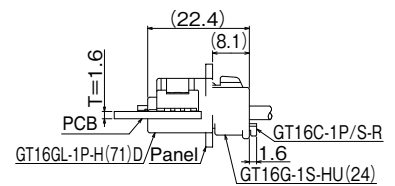

Note : Adjust size A of a microstrip line to satisfy 50Ω characteristic impedance.

Part No.	HRS No.	Part	Materials	Finish or color	Sales unit	RoHS
GT16GL-1P-H(71)D	766-0103-2	Housing	PPS	Black	200 pcs/reel	○
		Center terminal	Phosphor bronze	Tin plating		
		Outer terminal	Phosphor bronze	Tin plating		
		Insulator	PPS	Natural		
		Metal peg	Brass	Tin plating		

◆GT16GRL-1P-H (Metal peg : Lead reflow type)



◆Dimension

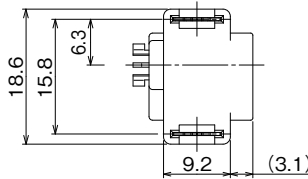

◆Recommended panel dimension

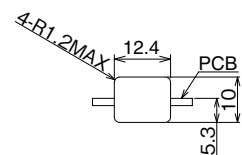

◆Recommended PCB Layout

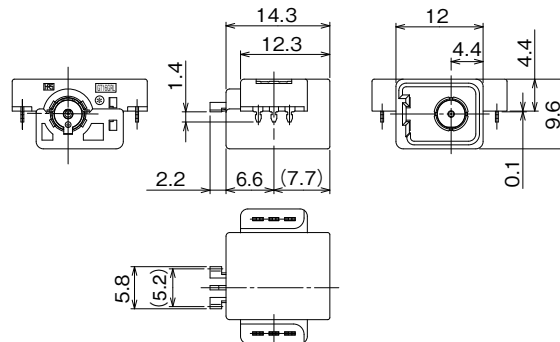
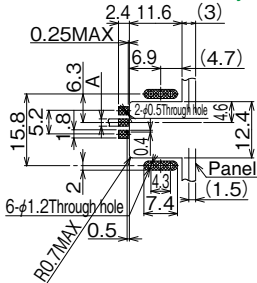

◆Mated condition

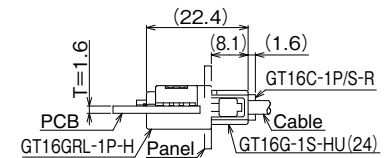

Note : Adjust size A of a microstrip line to satisfy 50Ω characteristic impedance.

Part No.	HRS No.	Part	Materials	Finish or color	Sales unit	RoHS
GT16GRL-1P-H	766-0101-7	Housing	PPS	Black	200 pcs/reel	○
		Center terminal	Phosphor bronze	Tin plating		
		Outer terminal	Phosphor bronze	Tin plating		
		Insulator	PPS	Natural		
		Metal peg	Brass	Tin plating		

●Lead reflow type (onboard)

◆GT16GH-1P-DSA



◆Dimension

◆Mated condition

◆Recommended PCB Layout

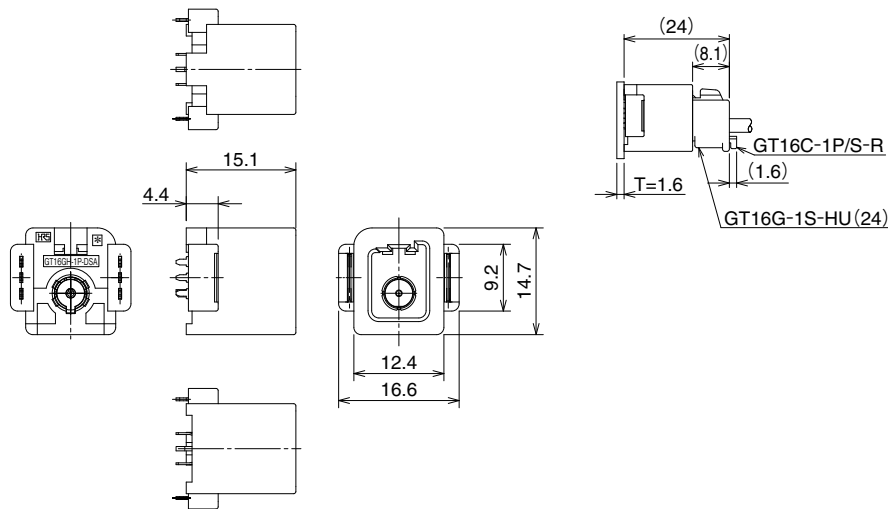
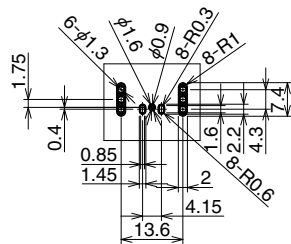

Part No.	HRS No.	Part	Materials	Finish or color	Sales unit	RoHS
GT16GH-1P-DSA	766-0112-3	Housing	PPS	Black	1 piece	○
		Center terminal	Phosphor bronze	Tin plating		
		Outer terminal	Phosphor bronze	Tin plating		
		Insulator	PPS	Natural		
		Metal peg	Brass	Tin plating		

●GT16G Series Conversion Adapter

◆SMA Conversion Adapter



◆Dimension

◆Dimension

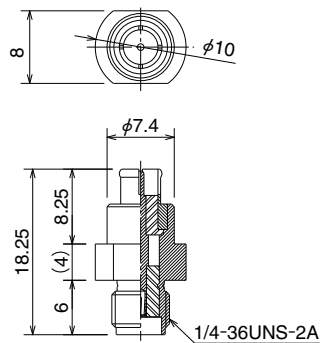
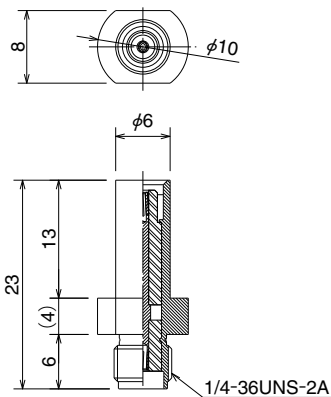

Part No.	HRS No.	Sales unit	RoHS
GT16GS-HRMJ	766-0031-3	1 piece	○
GT16GP-HRMJ	766-0030-0	1 piece	○

Note : The adapter does not have a lock portion and thus can only be used for performance measurements.

◆GT16G Wiring Method

①Strip the cable.

- Note 1 : See "Crimping Quality Standards Manual" for information about the end processing dimensions.
- Note 2 : Before performing end processing, arrange cable ends to be perpendicular. (There shall be no cable crushing.)
- Note 3 : Care must be taken so as not to damage the various cut portions of the Internal conductor, dielectric, and external conductor.

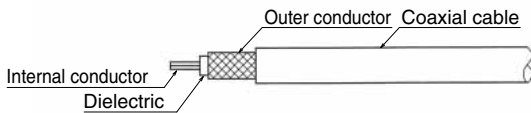

②Crimp the center contact with the special jig.

- Note 1 : See "Crimping Conditions Table" for information about the crimp height.
- Note 2 : See "Crimping Quality Standards Manual" for information about crimping standards.

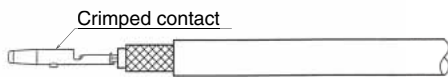

③Place the outer contact over the cable.

- Note 1 : Pay attention to the placement direction of the outer contact.

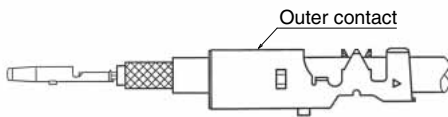

④Widen the external conductor with the special tool, place the outer ferrule, and return the external conductor over the outer ferrule.

- Note 1 : Spread only the external conductor without unravelling. Copper foil or aluminum foil shall not be spread, but shall be on the inside of the outer ferrule.
- Note 2 : The orientation of the outer ferrule shall be as indicated in the diagram. Align the slit of the outer ferrule with the protruding portion of the crimp contact and insert.
- Note 3 : The outer ferrule shall be placed so that the portion of different level is inserted as far as the sheath end.
- Note 4 : Pay attention to pinching of the external conductor (i.e., biting into the sheath) during the placement.

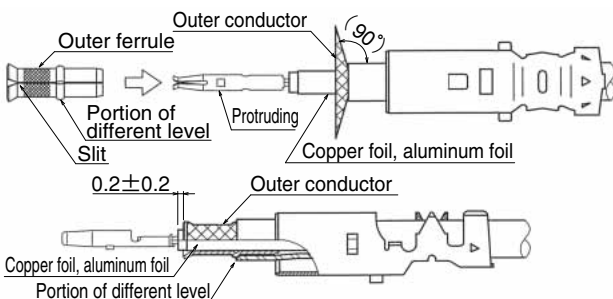

⑤Using the special jig, insert the contact ferrule from the coupling side of the crimp terminal until it reaches the end.

- Note 1 : Orient the contact ferrule as illustrated in the diagram, align the slit portion of the contact ferrule with the protruding portion of the crimp terminal, and then insert.

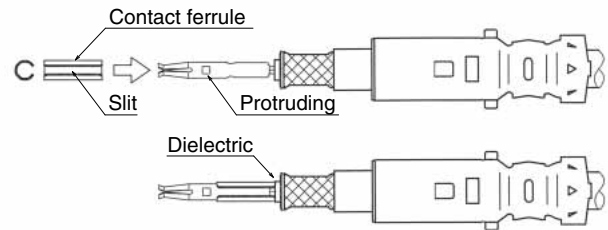

⑥Set the aforementioned contact unit onto the insulator and enclose it from the top with one more insulator.

- Note 1 : Set the protruding portion of the crimp contact in the groove hole of the insulator.
- Note 2 : Pull the cable with a force on the order of 4.9N and check that the terminal block does not come out.

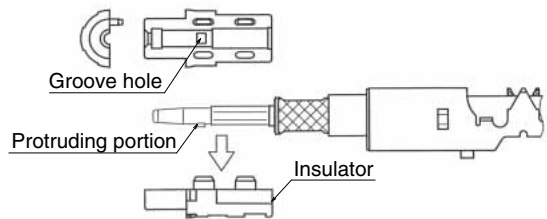

⑦Use the special tool to cover the insulator with the outer contact, which was previously inserted.

- Note 1 : Orient the outer contact as illustrated in the diagram, align the punched-in portion of the outer contact with the groove portion of the insulator (so that at both left and right, the slit of the outer ferrule is aligned with the barrel bottom portion of the outer contact), and then insert.
- Note 2 : Insert until the insulator stops at the lance of the outer contact.

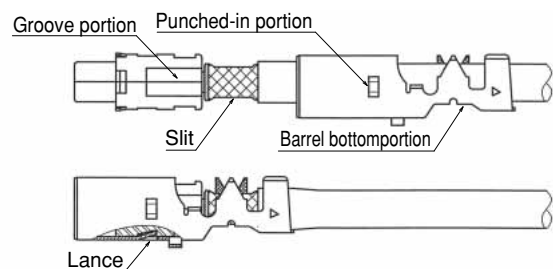

⑧ Use the special jig to crimp the outer contact.

Note 1 : See "Crimping Conditions Table" for information about the crimping height.

Note 2 : See "Crimping Quality Standards Manual" for information about crimping standards.

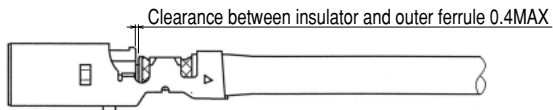

⑨ Insert the aforementioned outer contact unit into the housing.

Note 1 : Align the protruding portion of the outer contact with the groove portion of the housing, and then insert.

Note 2 : Insert until the outer contact stops at the lance of the housing.

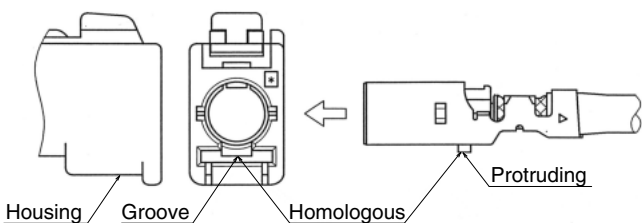

⑩ Insert the retainer into the housing.

Note 1 : Insert until the retainer stops at the housing.

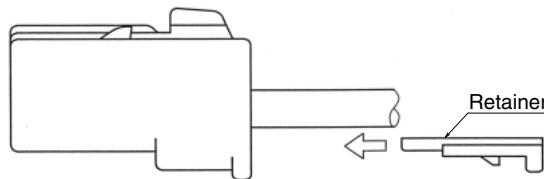

⑪ Inspect and complete the wiring.

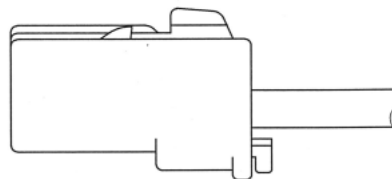

Note 1 : The length (L) dimension after wiring and the cut cable length are described below.

Cut cable length: L1 - 8.1
L2 + 11.0

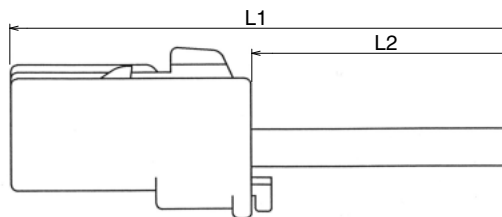

*The cable length differs depending on the housing type. Please contact Hirose for details.

● Wiring Tools

Applicable Connectors		GT16GM-1S-ASS GT16G-1S-ASSY GT16GT-1S-ASSY GT16GW-1S-ASSY	GT16GM-1P-ASSY GT16GMN-1PP-ASSY GT16GT-1PP-ASSY GT16GW-1P-ASSY
Process 1	Cable strip processing	Schleuniger MP257, etc. (Commercial product)	Schleuniger MP257, etc. (Commercial product)
Process 2	Center contact crimping	Crimping machine body type 105C + AP105-GT16G-2428S	Crimping machine body type 105C + AP105-GT16G-2428P
Process 3	Cable forming	Shield forming tool GT16G-1.5DHQS/CF-MD	Shield forming tool GT16G-1.5DHQS/CF-MD
Process 4	Outer ferrule insertion	Outer ferrule insertion tool GT16G-1.5DHQS/PR-MD	Outer ferrule insertion tool GT16G-1.5DHQS/PR-MD
Process 5	Contact ferrule insertion	Contact ferrule insertion tool GT16G-FR/PR-MD	Contact ferrule insertion tool GT16G-FR/PR-MD
Process 6	Insulator assembly	Manual task	Manual task
Process 7	Outer contact insertion	Insulator press tool GT16G-SC/PR-MD	—
Process 8	Outer contact tightening	Hand press MOS-7 + GT16G-1.6-2.9S/CK-MP	Hand press MOS-7 + GT16G-1.6-2.9P/CK-MP
Process 9	Housing, (retainer) assembly	Manual task	Manual task
Process 10	Inspection	High frequency characteristics test (Complete) Continuity / Withstand voltage test Inspection of external appearance	High frequency characteristics test (Complete) Continuity / Withstand voltage test Inspection of external appearance

◆ Precautions

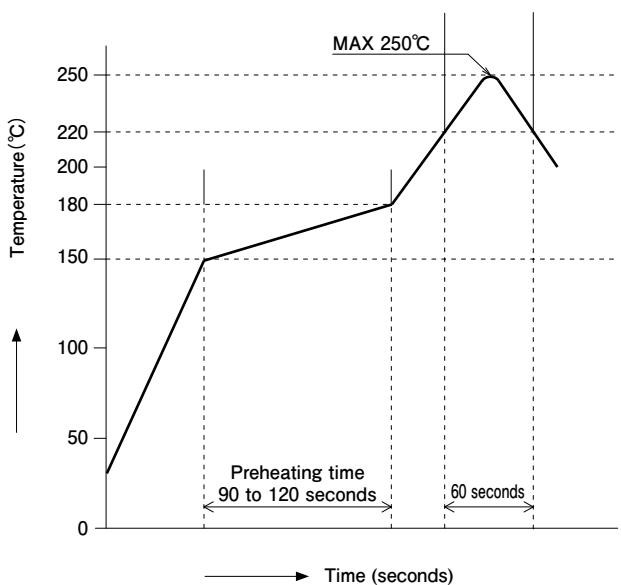
<p>1. Recommended temperature profile</p>	 <p>[Conditions]</p> <ol style="list-style-type: none"> 1. Peak temperature : 250°C 2. Heating unit : 220°C min, 60 sec max. 3. Preheating unit : 150 to 180°C for 90 to 120 seconds 4. Number of times : 2 times max <p>Note 1 : The temperature is the surface temperature of the PCB in the vicinity of the connector lead part.</p> <p>Note 2 : When you use nitrogen reflow, please mount the product with the oxygen concentration at a minimum of 1,000 [ppm]. Please contact us if the concentration is below 1,000 [ppm].</p>
<p>2. Recommended hand soldering conditions</p>	<p>Soldering iron temperature : 340 ± 10°C, Soldering time : within 3 seconds</p>
<p>3. Recommended screen thickness/aperture ratio (pattern area ratio)</p>	<p>Thickness : 0.15mm Aperture ratio : 100%</p>
<p>4. Cleaning</p>	<p>Not recommended. If you clean this product, please evaluate the performance before using it. (Cleaning may cause a change in the mating/unmating property and its resistance to environment)</p>
<p>5. Notes</p>	<ul style="list-style-type: none"> ■ Care should be taken that mating/unmating operation when the product is not mounted on the PCB could cause damage or deformation, etc. of the contact. ■ Avoid supporting the PCB only by connectors, and support it by other means than connectors. ■ Care should be taken that excessive prying mating/unmating could cause damage. ■ During hand soldering, do not apply flux which will cause flux oozing on connector.



HIROSE ELECTRIC CO.,LTD.

2-6-3,Nakagawa Chuoh,Tsuzuki-Ku,Yokohama-Shi 224-8540,JAPAN
 TEL: +81-45-620-3526 Fax: +81-45-591-3726
<http://www.hirose.com>
<http://www.hirose-connectors.com>

Данный компонент на территории Российской Федерации

Вы можете приобрести в компании MosChip.

Для оперативного оформления запроса Вам необходимо перейти по данной ссылке:

<http://moschip.ru/get-element>

Вы можете разместить у нас заказ для любого Вашего проекта, будь то серийное производство или разработка единичного прибора.

В нашем ассортименте представлены ведущие мировые производители активных и пассивных электронных компонентов.

Нашей специализацией является поставка электронной компонентной базы двойного назначения, продукции таких производителей как XILINX, Intel (ex.ALTERA), Vicor, Microchip, Texas Instruments, Analog Devices, Mini-Circuits, Amphenol, Glenair.

Сотрудничество с глобальными дистрибьюторами электронных компонентов, предоставляет возможность заказывать и получать с международных складов практически любой перечень компонентов в оптимальные для Вас сроки.

На всех этапах разработки и производства наши партнеры могут получить квалифицированную поддержку опытных инженеров.

Система менеджмента качества компании отвечает требованиям в соответствии с ГОСТ Р ИСО 9001, ГОСТ РВ 0015-002 и ЭС РД 009

Офис по работе с юридическими лицами:

105318, г.Москва, ул.Щербаковская д.3, офис 1107, 1118, ДЦ «Щербаковский»

Телефон: +7 495 668-12-70 (многоканальный)

Факс: +7 495 668-12-70 (доб.304)

E-mail: info@moschip.ru

Skype отдела продаж:

moschip.ru

moschip.ru_4

moschip.ru_6

moschip.ru_9