

## Resonant Switching Series

Reverse conducting IGBT with monolithic body diode

IHW30N135R3

Data sheet

Industrial Power Control

### Reverse conducting IGBT with monolithic body diode

#### Features:

- Offers new higher breakdown voltage to 1350V for improved reliability
- Powerful monolithic body diode with low forward voltage designed for soft commutation only
- TRENCHSTOP™ technology offering:
  - very tight parameter distribution
  - high ruggedness, temperature stable behavior
  - low  $V_{CEsat}$
  - easy parallel switching capability due to positive temperature coefficient in  $V_{CEsat}$
- Low EMI
- Qualified according to JESD-022 for target applications
- Pb-free lead plating; RoHS compliant
- Halogen free (according to IEC 61249-2-21)
- Complete product spectrum and PSpice Models:  
<http://www.infineon.com/igbt/>

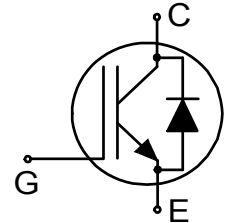

#### Applications:

- Inductive cooking
- Inverterized microwave ovens
- Resonant converters
- Soft switching applications

#### Package pin definition:

- Pin 1 - gate
- Pin 2 & backside - collector
- Pin 3 - emitter



#### Key Performance and Package Parameters

Type	$V_{CE}$	$I_C$	$V_{CEsat}, T_{vj}=25^{\circ}C$	$T_{vjmax}$	Marking	Package
IHW30N135R3	1350V	30A	1.65V	175°C	H30R1353	PG-TO247-3

**Table of Contents**

Description .....	2
Table of Contents .....	3
Maximum Ratings .....	4
Thermal Resistance .....	4
Electrical Characteristics .....	5
Electrical Characteristics Diagrams .....	7
Package Drawing .....	13
Testing Conditions .....	14
Revision History .....	15
Disclaimer .....	15

**Maximum Ratings**

For optimum lifetime and reliability, Infineon recommends operating conditions that do not exceed 80% of the maximum ratings stated in this datasheet.

Parameter	Symbol	Value	Unit
Collector-emitter voltage	$V_{CE}$	1350	V
DC collector current, limited by $T_{vjmax}$ $T_C = 25^\circ\text{C}$ $T_C = 100^\circ\text{C}$	$I_C$	60.0 30.0	A
Pulsed collector current, $t_p$ limited by $T_{vjmax}$	$I_{Cpuls}$	90.0	A
Turn off safe operating area $V_{CE} \leq 1350\text{V}$ , $T_{vj} \leq 175^\circ\text{C}$	-	90.0	A
Diode forward current, limited by $T_{vjmax}$ $T_C = 25^\circ\text{C}$ $T_C = 100^\circ\text{C}$	$I_F$	60.0 30.0	A
Diode pulsed current, $t_p$ limited by $T_{vjmax}$	$I_{Fpuls}$	90.0	A
Gate-emitter voltage Transient Gate-emitter voltage ( $t_p \leq 10\mu\text{s}$ , $D < 0.010$ )	$V_{GE}$	$\pm 20$ $\pm 25$	V
Power dissipation $T_C = 25^\circ\text{C}$ Power dissipation $T_C = 100^\circ\text{C}$	$P_{tot}$	349.0 175.0	W
Operating junction temperature	$T_{vj}$	-40...+175	$^\circ\text{C}$
Storage temperature	$T_{stg}$	-55...+175	$^\circ\text{C}$
Soldering temperature, wave soldering 1.6mm (0.063in.) from case for 10s		260	$^\circ\text{C}$
Mounting torque, M3 screw Maximum of mounting processes: 3	$M$	0.6	Nm

**Thermal Resistance**

Parameter	Symbol	Conditions	Max. Value	Unit
<b>Characteristic</b>				
IGBT thermal resistance, junction - case	$R_{th(j-c)}$		0.43	K/W
Diode thermal resistance, junction - case	$R_{th(j-c)}$		0.43	K/W
Thermal resistance junction - ambient	$R_{th(j-a)}$		40	K/W

**Electrical Characteristic, at  $T_{vj} = 25^{\circ}\text{C}$ , unless otherwise specified**

Parameter	Symbol	Conditions	Value			Unit
			min.	typ.	max.	
<b>Static Characteristic</b>						
Collector-emitter breakdown voltage	$V_{(BR)CES}$	$V_{GE} = 0\text{V}, I_C = 0.50\text{mA}$	1350	-	-	V
Collector-emitter saturation voltage	$V_{CESat}$	$V_{GE} = 15.0\text{V}, I_C = 30.0\text{A}$ $T_{vj} = 25^{\circ}\text{C}$ $T_{vj} = 125^{\circ}\text{C}$ $T_{vj} = 175^{\circ}\text{C}$	-	1.65 1.90 2.00	1.85 -	V
Diode forward voltage	$V_F$	$V_{GE} = 0\text{V}, I_F = 30.0\text{A}$ $T_{vj} = 25^{\circ}\text{C}$ $T_{vj} = 125^{\circ}\text{C}$ $T_{vj} = 175^{\circ}\text{C}$	-	1.65 1.80 1.90	1.85 -	V
Gate-emitter threshold voltage	$V_{GE(th)}$	$I_C = 0.75\text{mA}, V_{CE} = V_{GE}$	5.1	5.8	6.4	V
Zero gate voltage collector current	$I_{CES}$	$V_{CE} = 1350\text{V}, V_{GE} = 0\text{V}$ $T_{vj} = 25^{\circ}\text{C}$ $T_{vj} = 175^{\circ}\text{C}$	-	-	100.0 2500.0	$\mu\text{A}$
Gate-emitter leakage current	$I_{GES}$	$V_{CE} = 0\text{V}, V_{GE} = 20\text{V}$	-	-	100	nA
Transconductance	$g_{fs}$	$V_{CE} = 20\text{V}, I_C = 30.0\text{A}$	-	25.6	-	S
Integrated gate resistor	$r_G$			none		$\Omega$

**Electrical Characteristic, at  $T_{vj} = 25^{\circ}\text{C}$ , unless otherwise specified**

Parameter	Symbol	Conditions	Value			Unit
			min.	typ.	max.	
<b>Dynamic Characteristic</b>						
Input capacitance	$C_{ies}$	$V_{CE} = 25\text{V}, V_{GE} = 0\text{V}, f = 1\text{MHz}$	-	2066	-	pF
Output capacitance	$C_{oes}$		-	67	-	
Reverse transfer capacitance	$C_{res}$		-	58	-	
Gate charge	$Q_G$	$V_{CC} = 1080\text{V}, I_C = 30.0\text{A},$ $V_{GE} = 15\text{V}$	-	263.0	-	nC
Internal emitter inductance measured 5mm (0.197 in.) from case	$L_E$		-	13.0	-	nH

**Switching Characteristic, Inductive Load**

Parameter	Symbol	Conditions	Value			Unit
			min.	typ.	max.	

**IGBT Characteristic, at  $T_{vj} = 25^{\circ}\text{C}$** 

Turn-off delay time	$t_{d(off)}$	$T_{vj} = 25^{\circ}\text{C},$	-	337	-	ns
Fall time	$t_f$	$V_{CC} = 600\text{V}, I_C = 30.0\text{A},$ $V_{GE} = 0.0/15.0\text{V},$	-	47	-	ns
Turn-off energy	$E_{off}$	$R_{G(on)} = 10.0\Omega, R_{G(off)} = 10.0\Omega,$ $L_{\sigma} = 220\text{nH}, C_{\sigma} = 40\text{pF}$ $L_{\sigma}, C_{\sigma}$ from Fig. E Energy losses include "tail" and diode reverse recovery.	-	1.93	-	mJ
Turn-off energy, soft switching	$E_{off}$	$dv/dt = 150.0\text{V}/\mu\text{s}$	-	0.41	-	mJ

**Switching Characteristic, Inductive Load**

Parameter	Symbol	Conditions	Value			Unit
			min.	typ.	max.	
<b>IGBT Characteristic, at <math>T_{vj} = 175^{\circ}\text{C}</math></b>						
Turn-off delay time	$t_{d(\text{off})}$	$T_{vj} = 175^{\circ}\text{C},$	-	410	-	ns
Fall time	$t_f$	$V_{CC} = 600\text{V}, I_C = 30.0\text{A},$ $V_{GE} = 0.0/15.0\text{V},$	-	100	-	ns
Turn-off energy	$E_{\text{off}}$	$R_{G(\text{on})} = 10.0\Omega, R_{G(\text{off})} = 10.0\Omega,$ $L\sigma = 220\text{nH}, C\sigma = 40\text{pF}$ $L\sigma, C\sigma$ from Fig. E Energy losses include "tail" and diode reverse recovery.	-	3.50	-	mJ
Turn-off energy, soft switching	$E_{\text{off}}$	$dv/dt = 150.0\text{V}/\mu\text{s}$	-	0.82	-	mJ

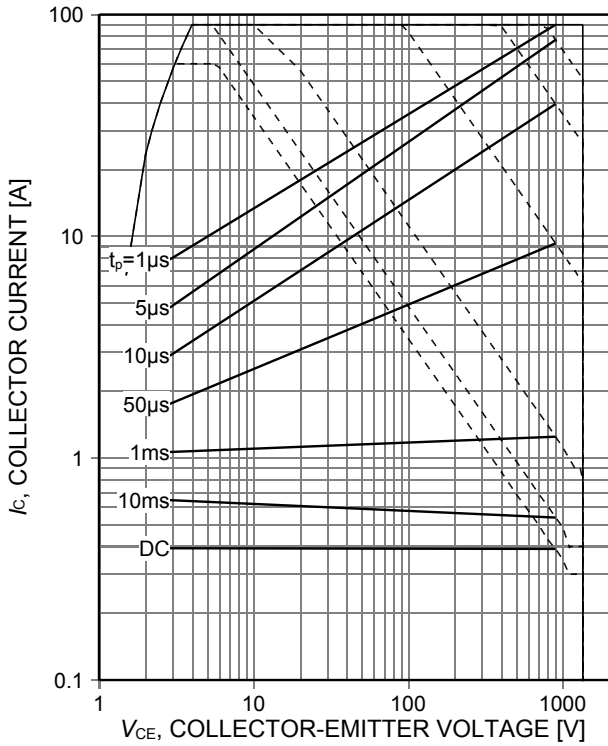

Figure 1. **Forward bias safe operating area**  
( $D=0$ ,  $T_C=25^\circ\text{C}$ ,  $T_{vj}\leq 175^\circ\text{C}$ ;  $V_{GE}=15\text{V}$ )

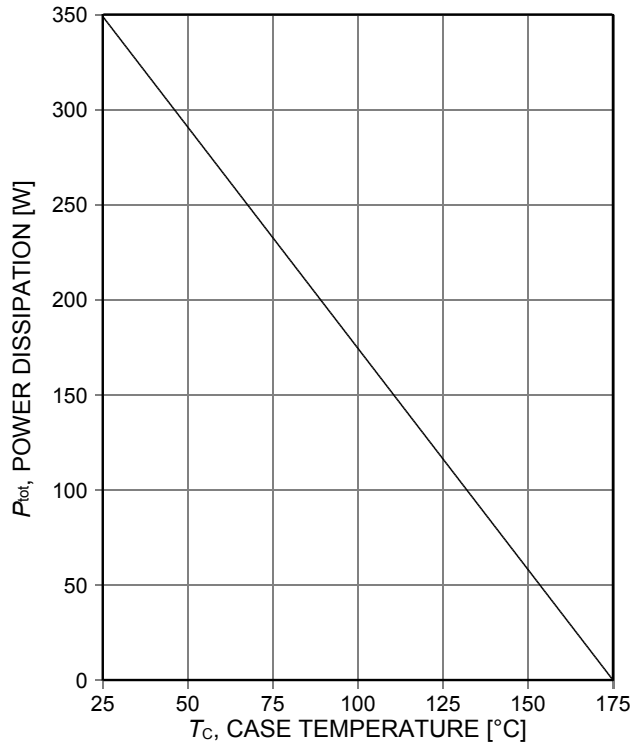

Figure 2. **Power dissipation as a function of case temperature**  
( $T_{vj}\leq 175^\circ\text{C}$ )

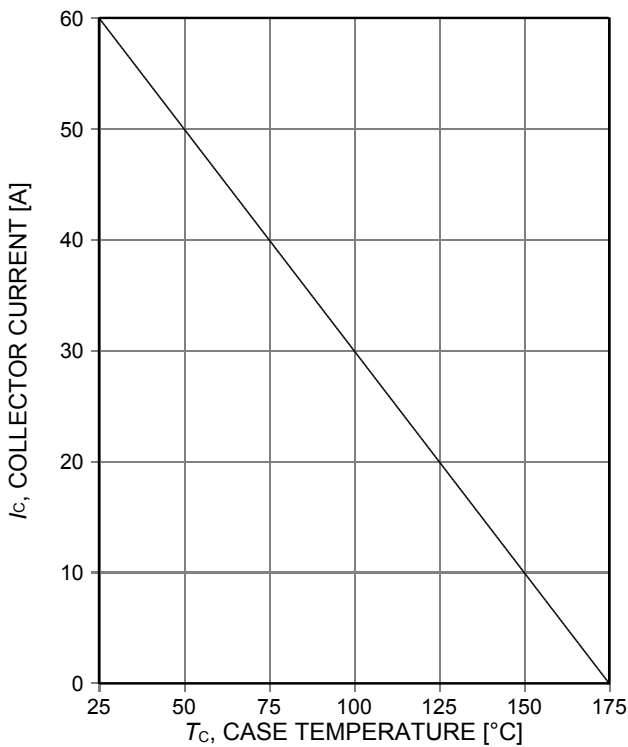

Figure 3. **Collector current as a function of case temperature**  
( $V_{GE}\geq 15\text{V}$ ,  $T_{vj}\leq 175^\circ\text{C}$ )

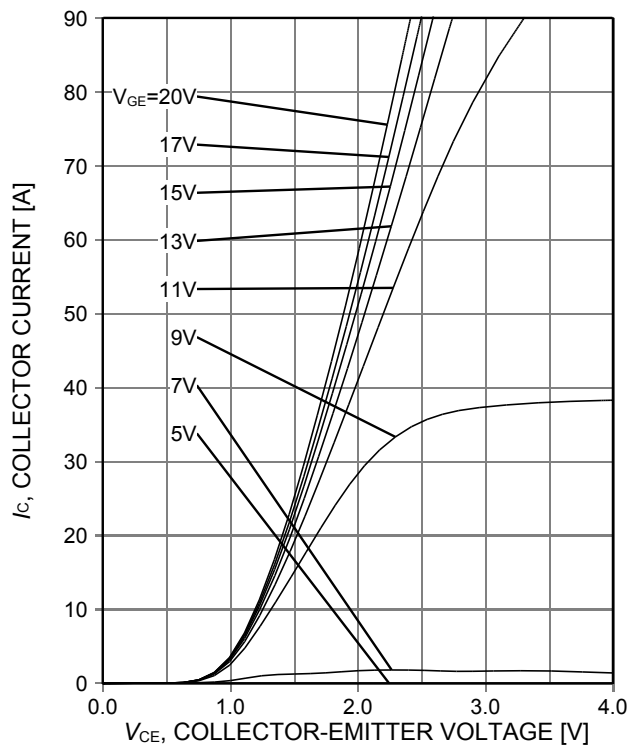

Figure 4. **Typical output characteristic**  
( $T_{vj}=25^\circ\text{C}$ )

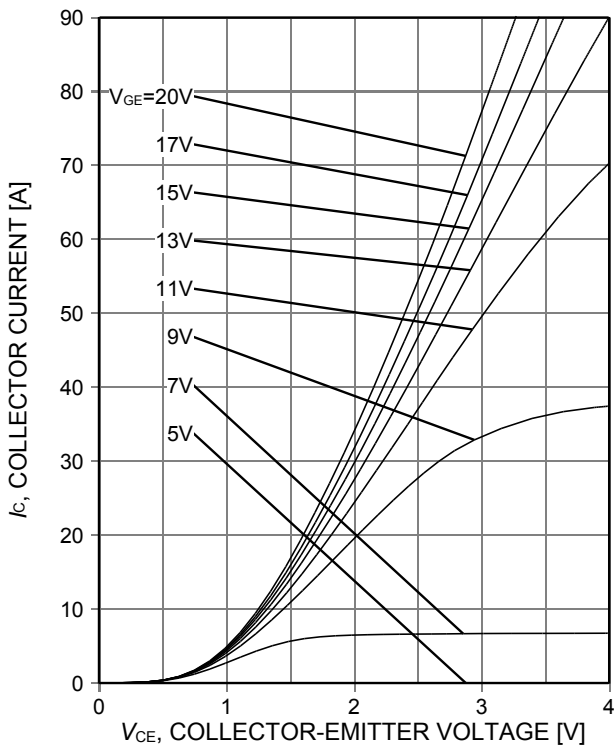

Figure 5. Typical output characteristic ( $T_{vj}=175^{\circ}\text{C}$ )

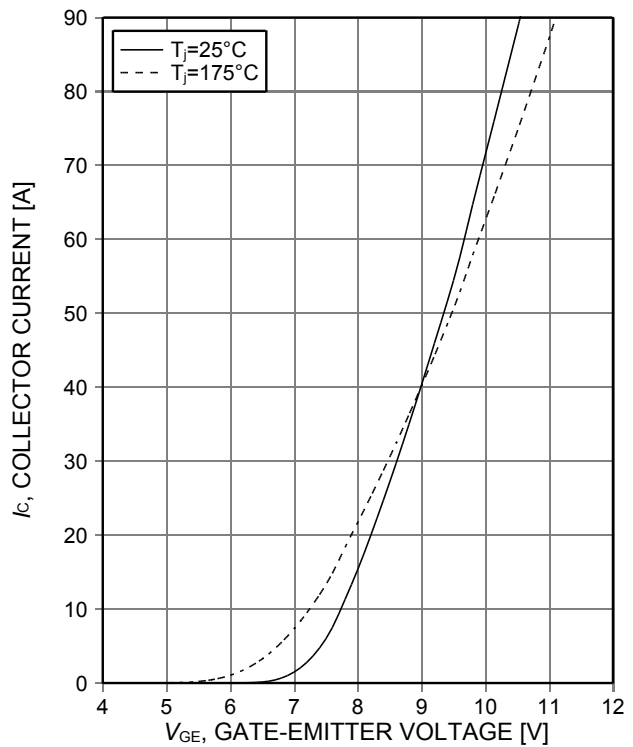

Figure 6. Typical transfer characteristic ( $V_{CE}=20\text{V}$ )

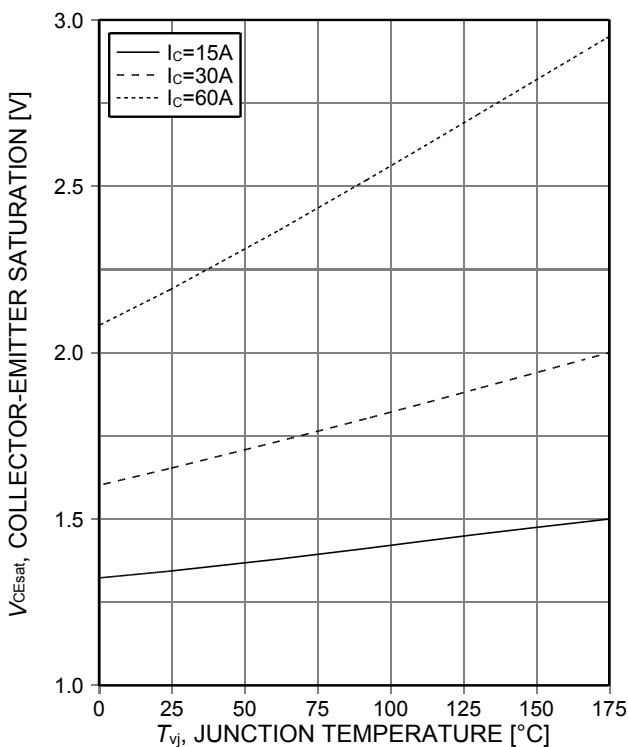

Figure 7. Typical collector-emitter saturation voltage as a function of junction temperature ( $V_{GE}=15\text{V}$ )

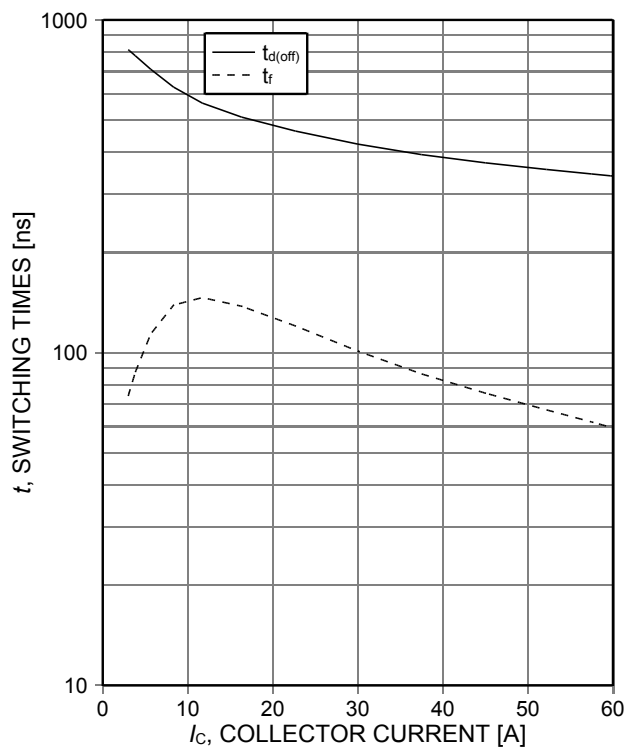

Figure 8. Typical switching times as a function of collector current (inductive load,  $T_{vj}=175^{\circ}\text{C}$ ,  $V_{CE}=600\text{V}$ ,  $V_{GE}=0/15\text{V}$ ,  $R_{G(on)}=10\Omega$ ,  $R_{G(off)}=10\Omega$ , dynamic test circuit in Figure E)



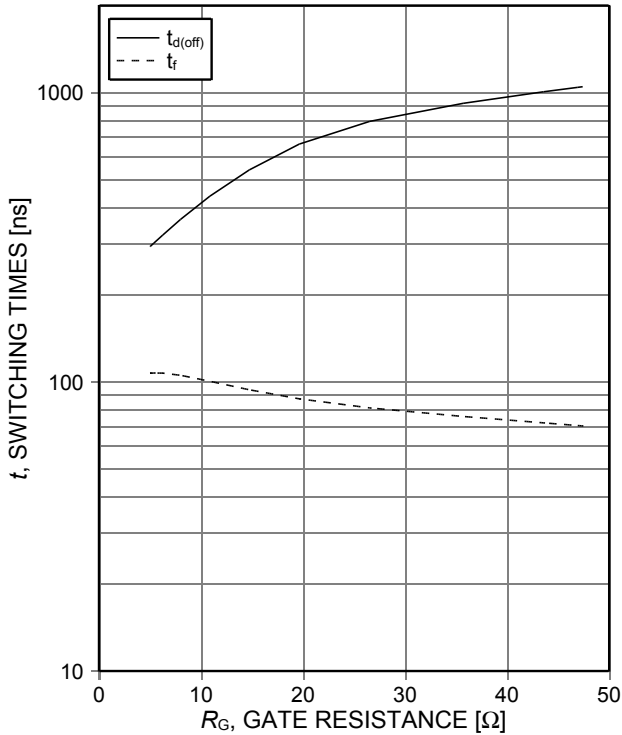

Figure 9. **Typical switching times as a function of gate resistance**  
 (inductive load,  $T_{vj}=175^{\circ}\text{C}$ ,  $V_{CE}=600\text{V}$ ,  $V_{GE}=0/15\text{V}$ ,  $I_C=30\text{A}$ , dynamic test circuit in Figure E)

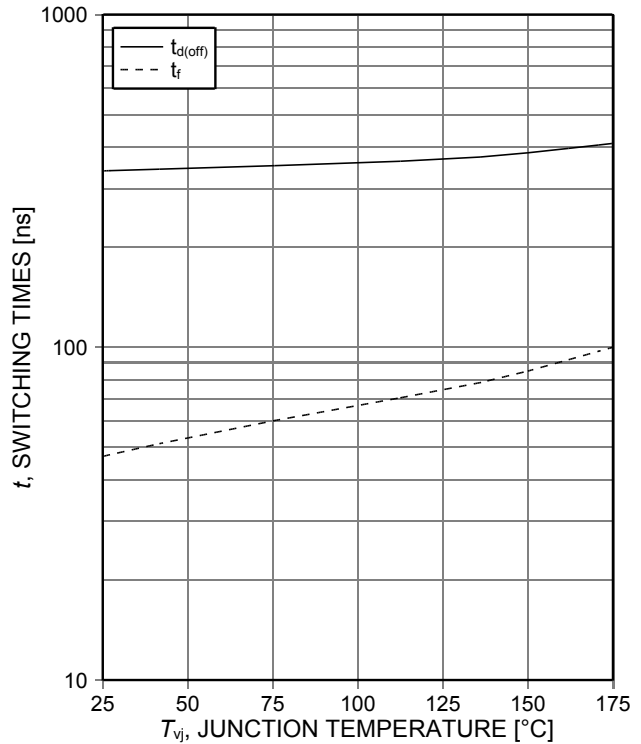

Figure 10. **Typical switching times as a function of junction temperature**  
 (inductive load,  $V_{CE}=600\text{V}$ ,  $V_{GE}=0/15\text{V}$ ,  $I_C=30\text{A}$ ,  $R_{G(on)}=10\Omega$ ,  $R_{G(off)}=10\Omega$ , dynamic test circuit in Figure E)

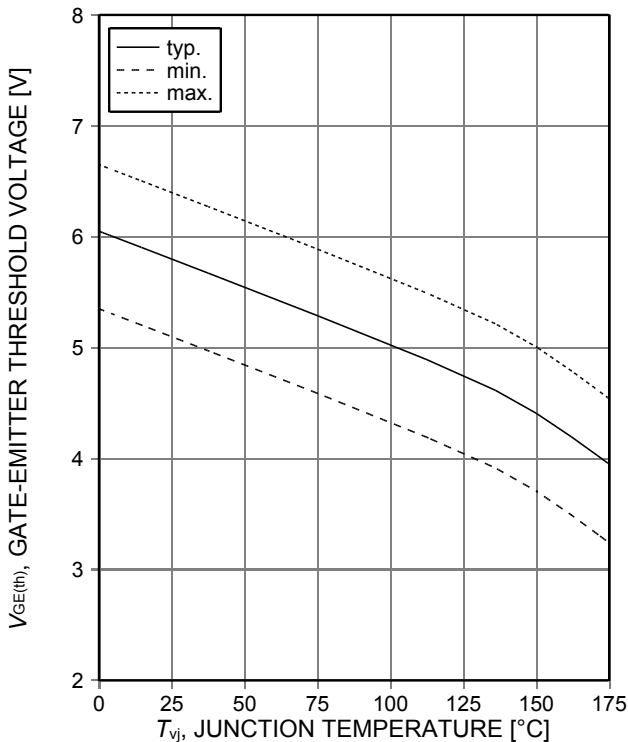

Figure 11. **Gate-emitter threshold voltage as a function of junction temperature**  
 ( $I_C=0.75\text{mA}$ )

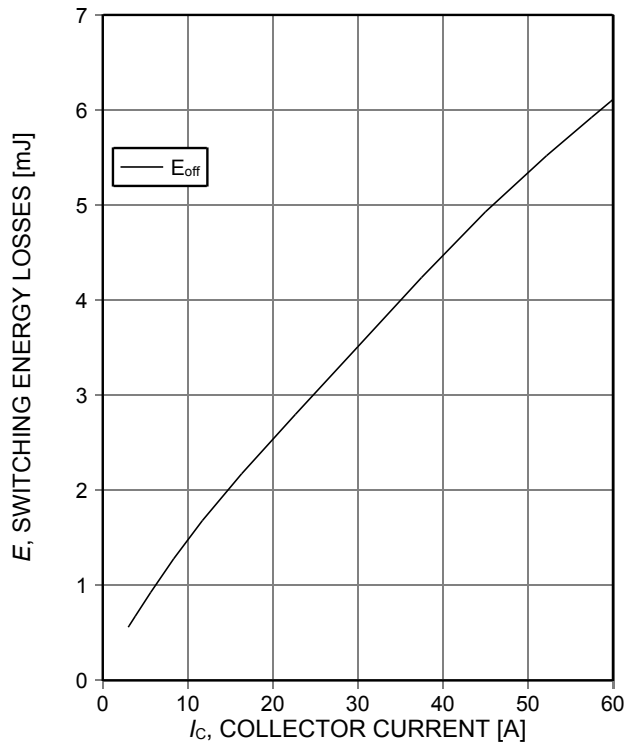

Figure 12. **Typical switching energy losses as a function of collector current**  
 (inductive load,  $T_{vj}=175^{\circ}\text{C}$ ,  $V_{CE}=600\text{V}$ ,  $V_{GE}=0/15\text{V}$ ,  $R_{G(on)}=10\Omega$ ,  $R_{G(off)}=10\Omega$ , dynamic test circuit in Figure E)

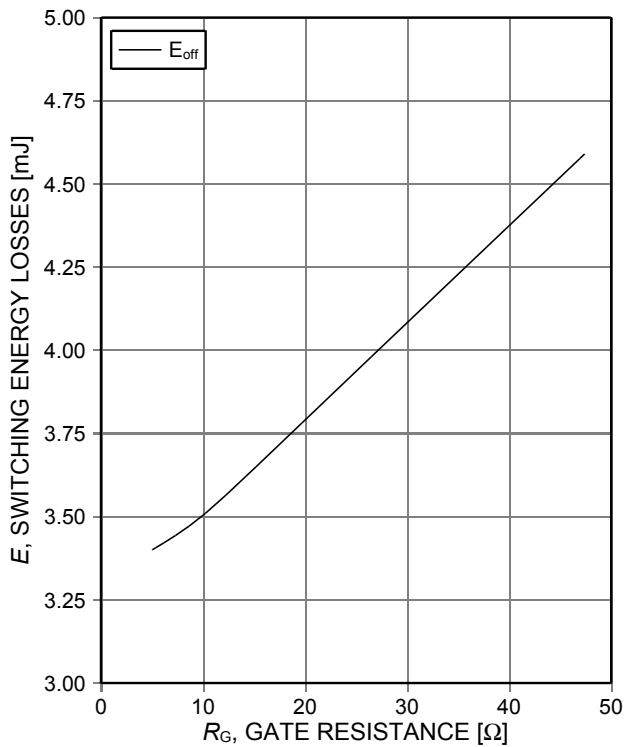

Figure 13. **Typical switching energy losses as a function of gate resistance**  
 (inductive load,  $T_{vj}=175^\circ\text{C}$ ,  $V_{CE}=600\text{V}$ ,  $V_{GE}=0/15\text{V}$ ,  $I_C=30\text{A}$ , dynamic test circuit in Figure E)

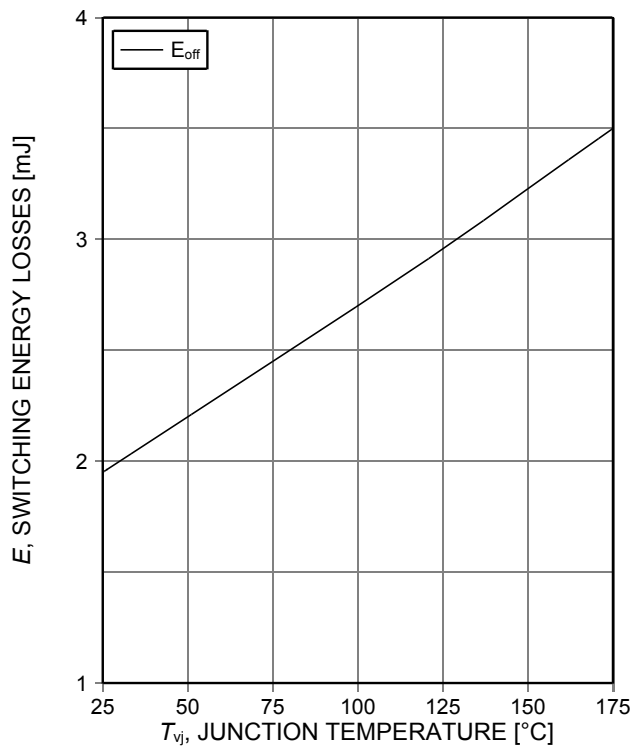

Figure 14. **Typical switching energy losses as a function of junction temperature**  
 (inductive load,  $V_{CE}=600\text{V}$ ,  $V_{GE}=0/15\text{V}$ ,  $I_C=30\text{A}$ ,  $R_{G(on)}=10\Omega$ ,  $R_{G(off)}=10\Omega$ , dynamic test circuit in Figure E)

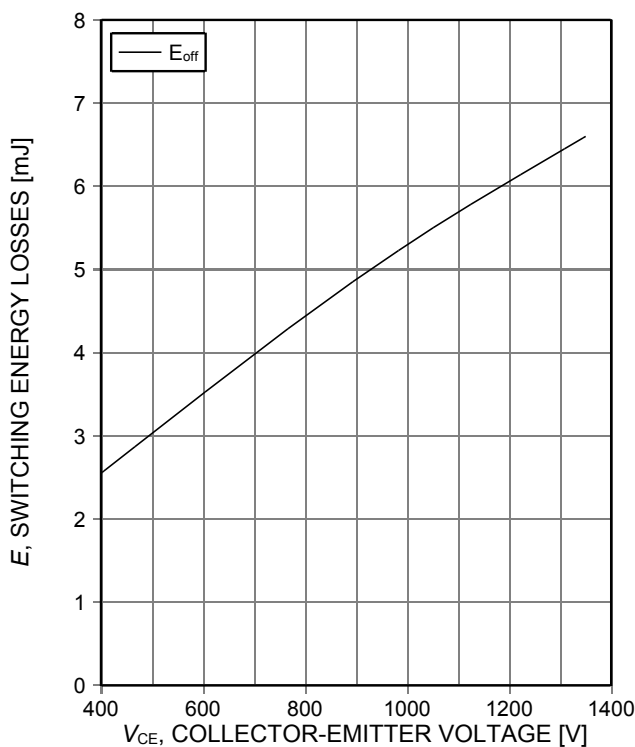

Figure 15. **Typical switching energy losses as a function of collector emitter voltage**  
 (inductive load,  $T_{vj}=175^\circ\text{C}$ ,  $V_{GE}=0/15\text{V}$ ,  $I_C=30\text{A}$ ,  $R_{G(on)}=10\Omega$ ,  $R_{G(off)}=10\Omega$ , dynamic test circuit in Figure E)

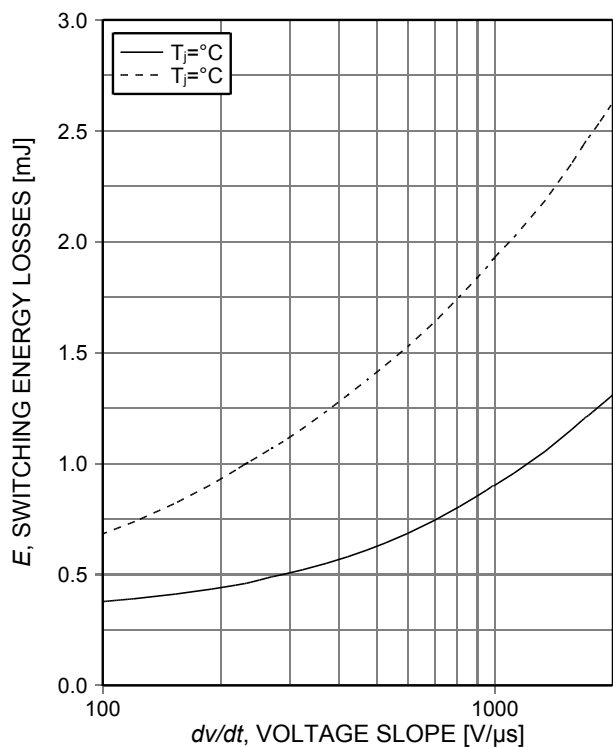

Figure 16. **Typical turn off switching energy loss for soft switching**  
 (inductive load,  $T_{vj}=175^\circ\text{C}$ ,  $V_{GE}=0/15\text{V}$ ,  $I_C=30\text{A}$ ,  $R_G=10\Omega$ , dynamic test circuit in Figure E)

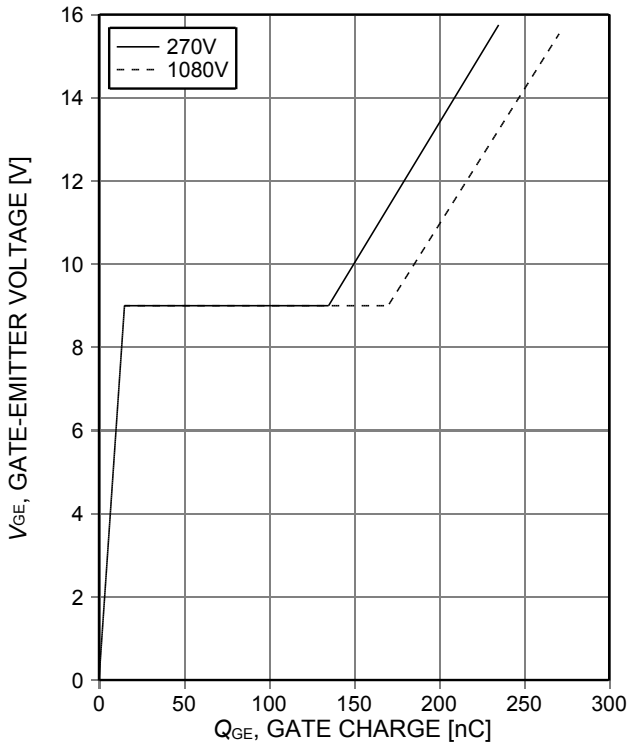

Figure 17. **Typical gate charge**  
( $I_C=30A$ )

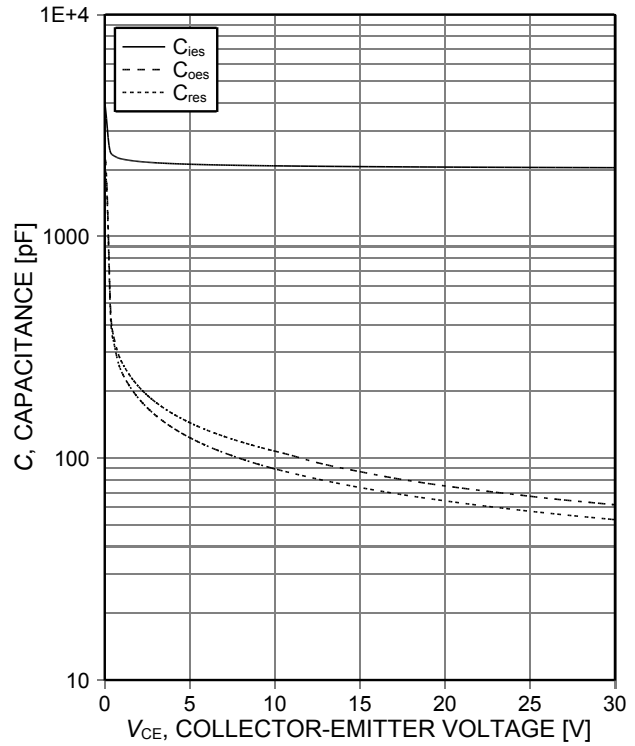

Figure 18. **Typical capacitance as a function of collector-emitter voltage**  
( $V_{GE}=0V$ ,  $f=1MHz$ )

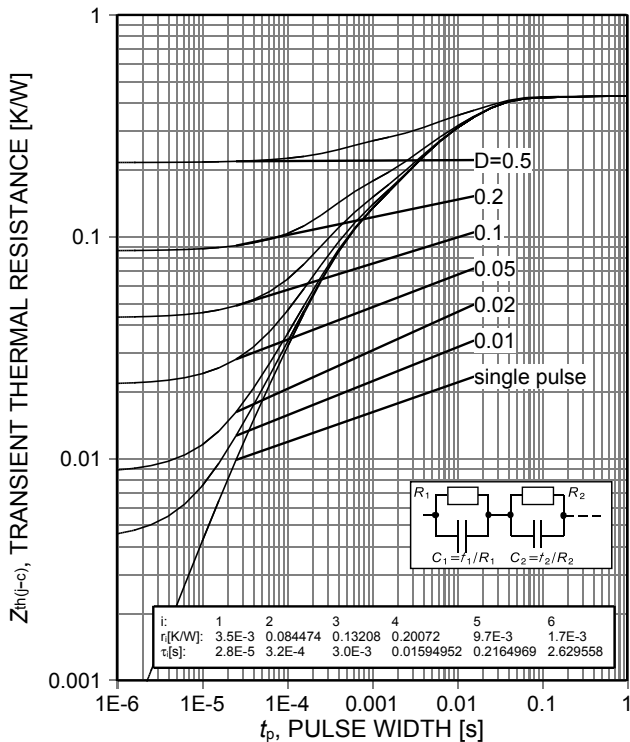

Figure 19. **IGBT transient thermal resistance**  
( $D=t_p/T$ )

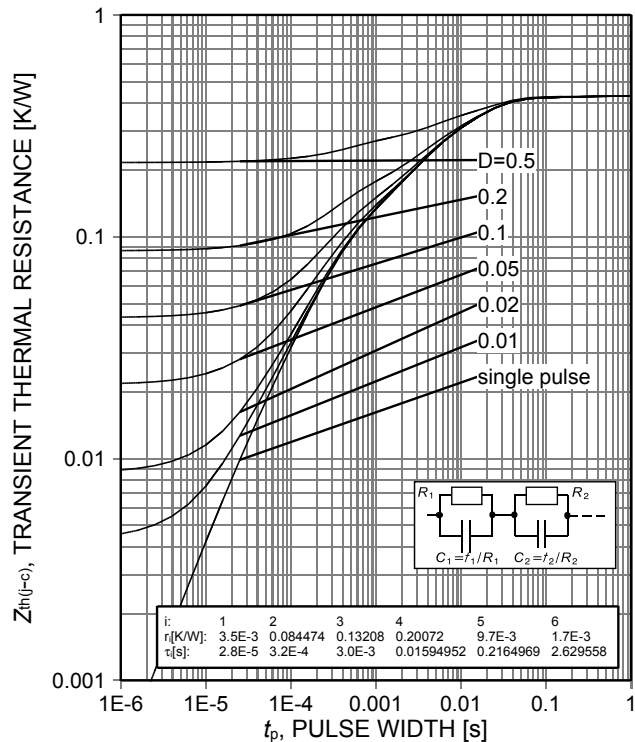

Figure 20. **Diode transient thermal impedance as a function of pulse width**  
( $D=t_p/T$ )

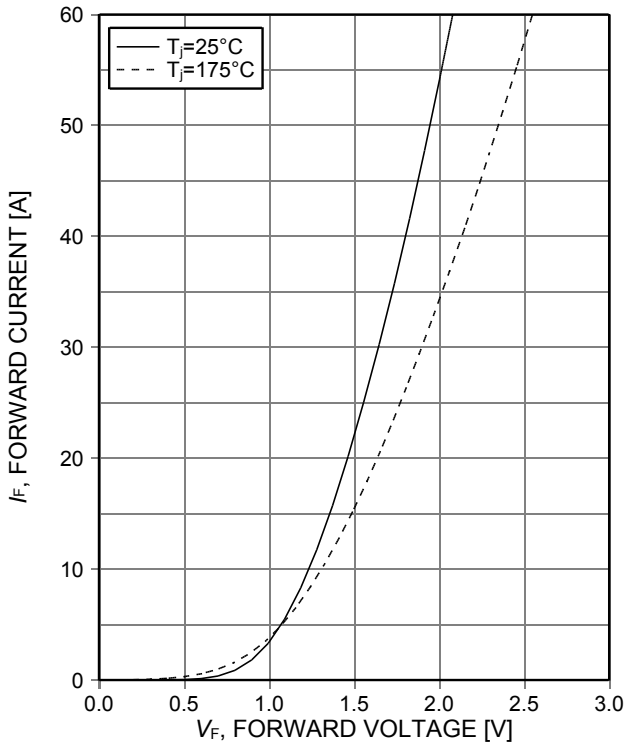

Figure 21. Typical diode forward current as a function of forward voltage

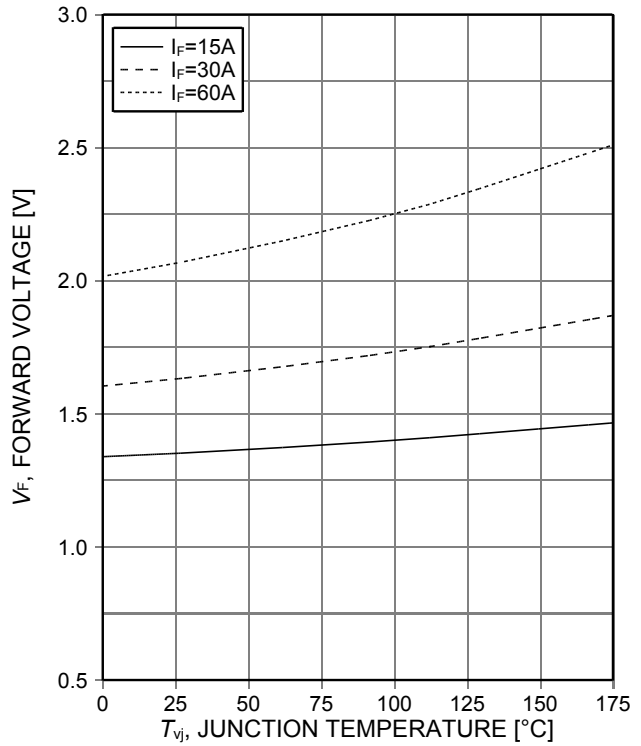

Figure 22. Typical diode forward voltage as a function of junction temperature

PG-TO247-3



DIM	MILLIMETERS		INCHES	
	MIN	MAX	MIN	MAX
A	4.83	5.21	0.190	0.205
A1	2.27	2.54	0.089	0.100
A2	1.85	2.16	0.073	0.085
b	1.07	1.33	0.042	0.052
b1	1.90	2.41	0.075	0.095
b2	1.90	2.16	0.075	0.085
b3	2.87	3.38	0.113	0.133
b4	2.87	3.13	0.113	0.123
c	0.55	0.68	0.022	0.027
D	20.80	21.10	0.819	0.831
D1	16.25	17.65	0.640	0.695
D2	0.95	1.35	0.037	0.053
E	15.70	16.13	0.618	0.635
E1	13.10	14.15	0.516	0.557
E2	3.68	5.10	0.145	0.201
E3	1.00	2.60	0.039	0.102
e	5.44 (BSC)		0.214 (BSC)	
N	3		3	
L	19.80	20.32	0.780	0.800
L1	4.10	4.47	0.161	0.176
øP	3.50	3.70	0.138	0.146
Q	5.49	6.00	0.216	0.236
S	6.04	6.30	0.238	0.248

DOCUMENT NO.  
Z8B00003327

SCALE  
0 5 5 7.5mm

EUROPEAN PROJECTION

ISSUE DATE  
09-07-2010

REVISION  
05



Figure A. Definition of switching times



Figure B. Definition of switching losses

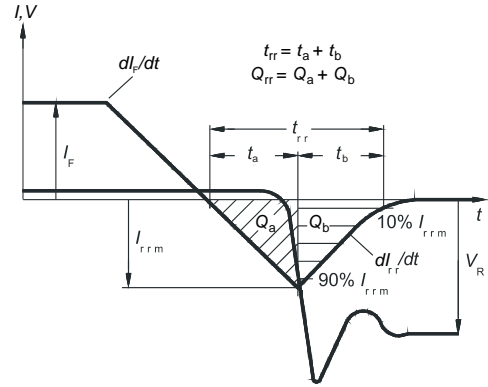

Figure C. Definition of diode switching characteristics

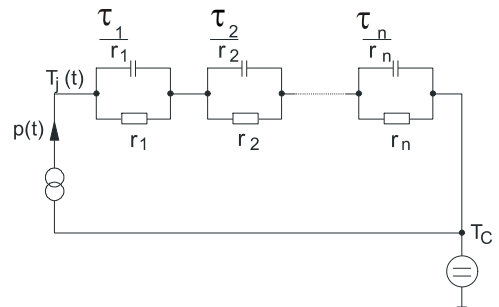

Figure D. Thermal equivalent circuit

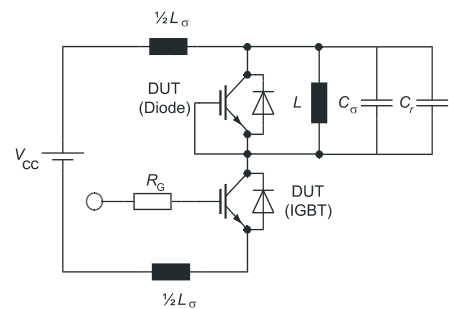

Figure E. Dynamic test circuit  
Parasitic inductance  $L_{\sigma}$ ,  
parasitic capacitor  $C_{\sigma}$ ,  
relief capacitor  $C_r$ ,  
(only for ZVT switching)

## Revision History

IHW30N135R3

Revision: 2015-01-26, Rev. 2.2

## Previous Revision

Revision	Date	Subjects (major changes since last revision)
2.1	2012-10-12	Final data sheet
2.2	2015-01-26	Minor changes

## We Listen to Your Comments

Any information within this document that you feel is wrong, unclear or missing at all?

Your feedback will help us to continuously improve the quality of this document.

Please send your proposal (including a reference to this document) to: [erratum@infineon.com](mailto:erratum@infineon.com)

## Published by

Infineon Technologies AG

81726 Munich, Germany

81726 München, Germany

© 2015 Infineon Technologies AG

All Rights Reserved.

## Legal Disclaimer

The information given in this document shall in no event be regarded as a guarantee of conditions or characteristics.

With respect to any examples or hints given herein, any typical values stated herein and/or any information regarding the application of the device, Infineon Technologies hereby disclaims any and all warranties and liabilities of any kind, including without limitation, warranties of non-infringement of intellectual property rights of any third party.

## Information

For further information on technology, delivery terms and conditions and prices, please contact the nearest Infineon Technologies Office ([www.infineon.com](http://www.infineon.com)).

## Warnings

Due to technical requirements, components may contain dangerous substances. For information on the types in question, please contact the nearest Infineon Technologies Office.

The Infineon Technologies component described in this Data Sheet may be used in life-support devices or systems and/or automotive, aviation and aerospace applications or systems only with the express written approval of Infineon Technologies, if a failure of such components can reasonably be expected to cause the failure of that life-support, automotive, aviation and aerospace device or system or to affect the safety or effectiveness of that device or system. Life support devices or systems are intended to be implanted in the human body or to support and/or maintain and sustain and/or protect human life. If they fail, it is reasonable to assume that the health of the user or other persons may be endangered.

## Данный компонент на территории Российской Федерации

### Вы можете приобрести в компании MosChip.

Для оперативного оформления запроса Вам необходимо перейти по данной ссылке:

<http://moschip.ru/get-element>

Вы можете разместить у нас заказ для любого Вашего проекта, будь то серийное производство или разработка единичного прибора.

В нашем ассортименте представлены ведущие мировые производители активных и пассивных электронных компонентов.

Нашей специализацией является поставка электронной компонентной базы двойного назначения, продукции таких производителей как XILINX, Intel (ex.ALTERA), Vicor, Microchip, Texas Instruments, Analog Devices, Mini-Circuits, Amphenol, Glenair.

Сотрудничество с глобальными дистрибьюторами электронных компонентов, предоставляет возможность заказывать и получать с международных складов практически любой перечень компонентов в оптимальные для Вас сроки.

На всех этапах разработки и производства наши партнеры могут получить квалифицированную поддержку опытных инженеров.

Система менеджмента качества компании отвечает требованиям в соответствии с ГОСТ Р ИСО 9001, ГОСТ РВ 0015-002 и ЭС РД 009

### Офис по работе с юридическими лицами:

105318, г.Москва, ул.Щербаковская д.3, офис 1107, 1118, ДЦ «Щербаковский»

Телефон: +7 495 668-12-70 (многоканальный)

Факс: +7 495 668-12-70 (доб.304)

E-mail: [info@moschip.ru](mailto:info@moschip.ru)

Skype отдела продаж:

moschip.ru

moschip.ru\_4

moschip.ru\_6

moschip.ru\_9