

9-line IPAD™, EMI filter and ESD protection

Features

- 9-line EMI low-pass filter and ESD protection
- High efficiency in EMI filtering
- Lead-free package
- 400 µm pitch
- Very low PCB space occupation: < 4 mm²
- Very thin package: 0.6 mm
- High reliability offered by monolithic integration
- Reduction of parasitic elements thanks to CSP integration

Complies with the following standards

- IEC61000-4-2 level 4 on external pins:
 - 15 kV (air discharge)
 - 8 kV (contact discharge)
- IEC61000-4-2 level 2 on internal pins:
 - 2 kV (air discharge)
 - 2 kV (contact discharge)
- MIL STD 883F - Method 3015.7 Class 3

Application

- Secure digital memory card in mobile phones and communication systems

Description

The EMIF09-SD01F3 is a highly integrated array designed to suppress EMI/RFI noise for secure digital memory cards. The EMIF09-SD01F3 is in a Flip Chip package to offer space saving and high RF performance.

This low-pass filter includes ESD protection circuitry, which prevents damage to the protected device when subjected to ESD surges up to 15 kV. This filter also has a low line capacitance to be compatible with high data rate signals.

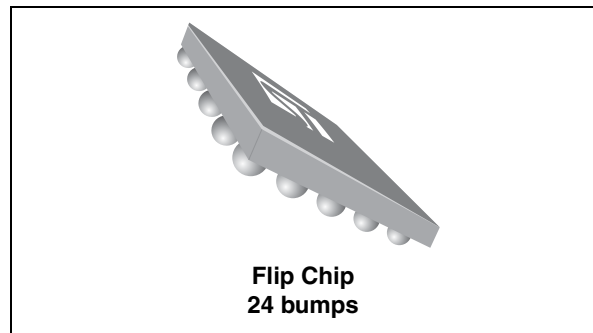
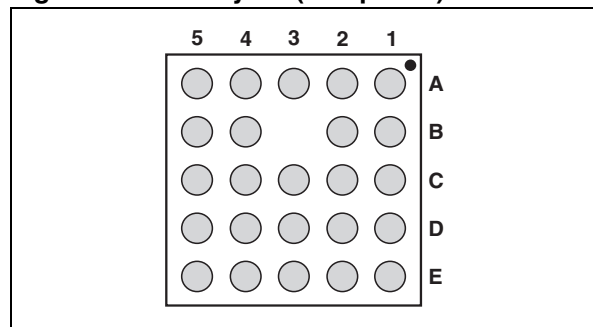

Figure 1. Pin layout (bump side)



TM: IPAD is a trademark of STMicroelectronics.

1 Characteristics

Figure 2. Device configuration

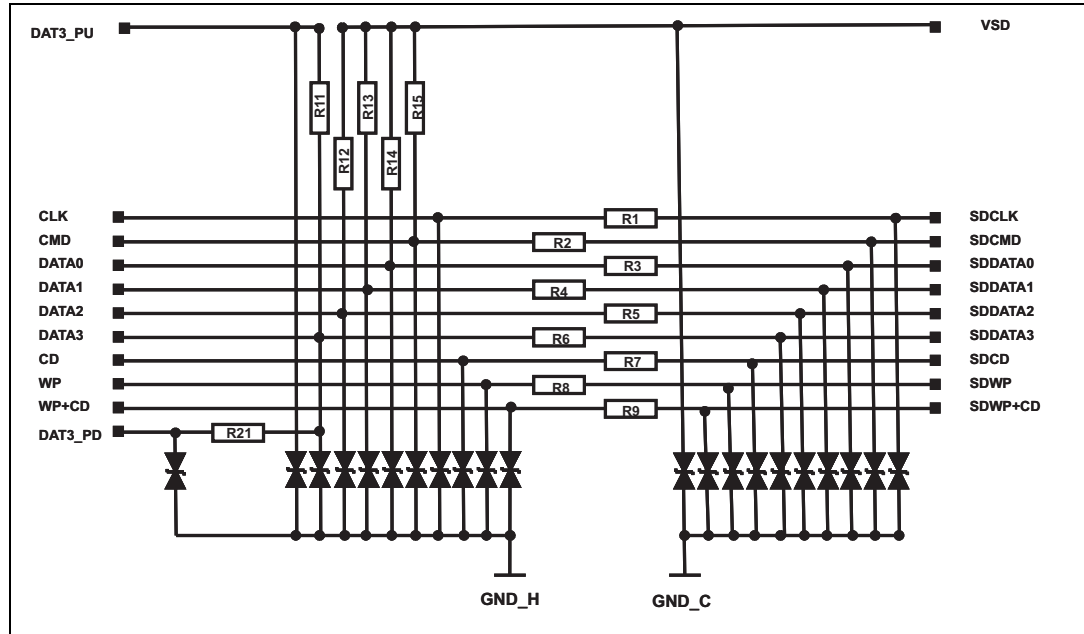

Table 1. Pin-signal attribution

Pin	Description	Pin	Description	Pin	Description	Pin	Description	Pin	Description
A1	DATA2	B1	CD	C1	DAT3_PD	D1	WP+CD	E1	DATA1
A2	DATA3	B2	CMD	C2	WP	D2	CLK	E2	DATA0
A3	GND_H	B3		C3	DAT3_PU	D3	GND_C	E3	GND_C
A4	SDDATA2	B4	SDCD	C4	SDWP	D4	SDWP+CD	E4	SDDATA1
A5	SDDATA3	B5	SDCMD	C5	VSD	D5	SDCLK	E5	SDDATA0

Table 2. Absolute ratings (limiting values)

Symbol	Parameter	Value	Unit
V_{PP}	Internal pins (A1, B1, C1, D1, E1, A2, B2, C2, D2, E2, C3)		
	ESD discharge IEC 61000-4-2, air discharge	2	kV
	ESD discharge IEC 61000-4-2, contact discharge	2	
	External pins (A4, B4, C4, D4, E4, A5, B5, C5, D5, E5)		
	ESD discharge IEC 61000-4-2, air discharge	15	
	ESD discharge IEC 61000-4-2, contact discharge	8	
T_j	Junction temperature	125	°C
T_{op}	Operating temperature range	-30 to + 85	°C
T_{stg}	Storage temperature range	-55 to 150	°C

GND bumps (GND_H and GND_C - A3, D3 and E3) must be connected to ground on the printed circuit board for ESD testing and RF measurements.

Table 3. Electrical characteristics ($T_{amb} = 25\text{ }^{\circ}\text{C}$)

Symbol	Parameters				
V_{BR}	Breakdown voltage				
I_{RM}	Leakage current @ V_{RM}				
V_{RM}	Stand-off voltage				
V_{CL}	Clamping voltage				
R_d	Dynamic impedance				
I_{PP}	Peak pulse current				
$R_{I/O}$	Series resistance between input and output				
C_{line}	Input capacitance per line				
Symbol	Test conditions				
V_{BR}	$I_R = 1\text{ mA}$	6		20	V
I_{RM}	$V_{RM} = 5\text{ V per line}$		50	200	nA
R1, R2, R3, R4, R5, R6, R7, R8, R9	Tolerance $\pm 20\%$		40		Ω
R11, R12, R13, R14	Tolerance $\pm 30\%$		50		k Ω
R15	Tolerance $\pm 30\%$		15		k Ω
R21	Tolerance $\pm 30\%$		470		k Ω
C_{line}	$V_{line} = 0\text{ V}$, $V_{OSC} = 30\text{ mV}$, $F = 1\text{ MHz}$ (under zero light conditions)			20	pF

Figure 3. S21(dB) all lines attenuation measurement

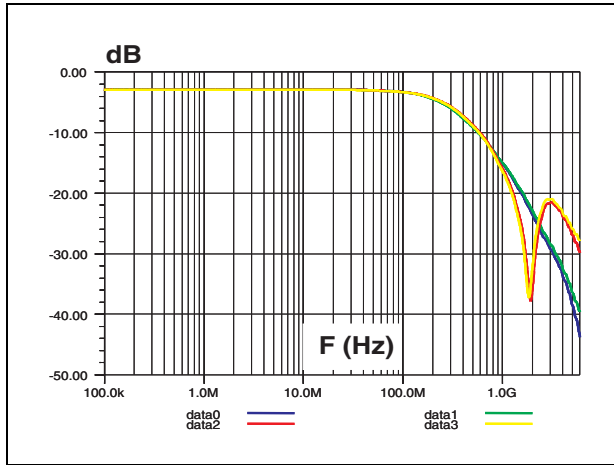

Figure 4. Analog cross talk measurement

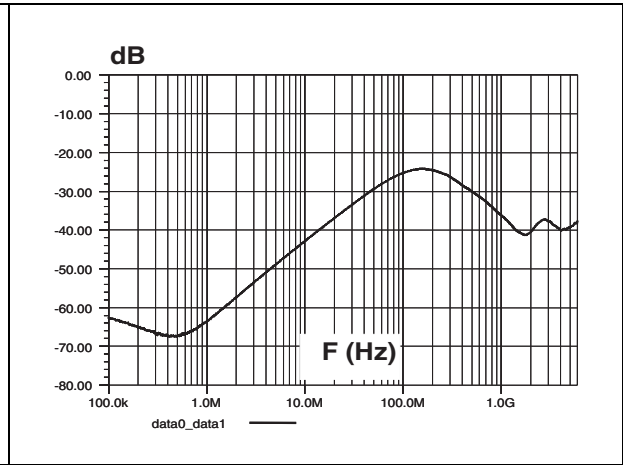

Figure 5. Digital crosstalk measurement

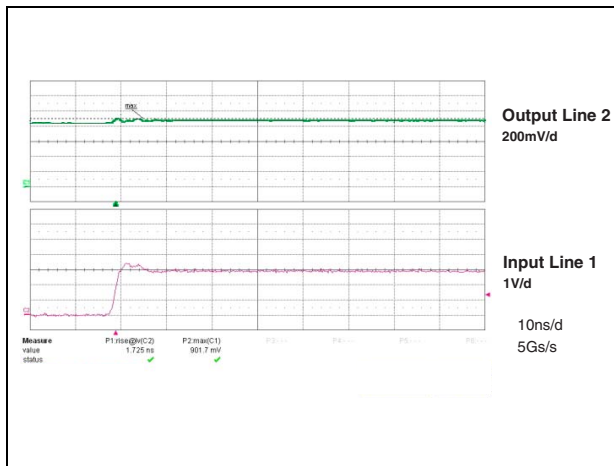

Figure 6. ESD response to IEC 61000-4-2 (+15 kV air discharge) on one input (V_{IN}) and on one output (V_{OUT})

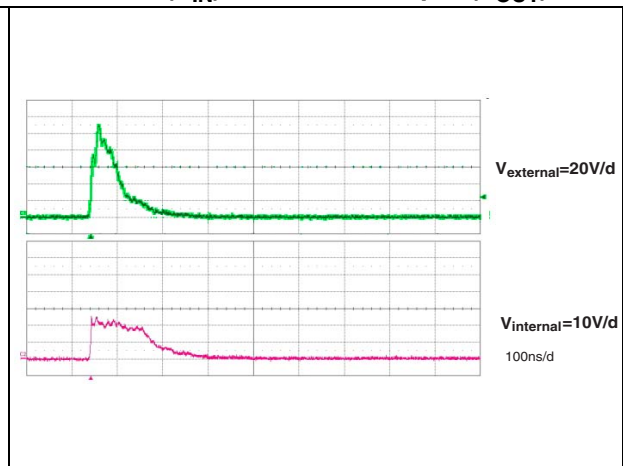

Figure 7. ESD response to IEC 61000-4-2 (-15 kV air discharge) on one input (V_{IN}) and on one output (V_{OUT})

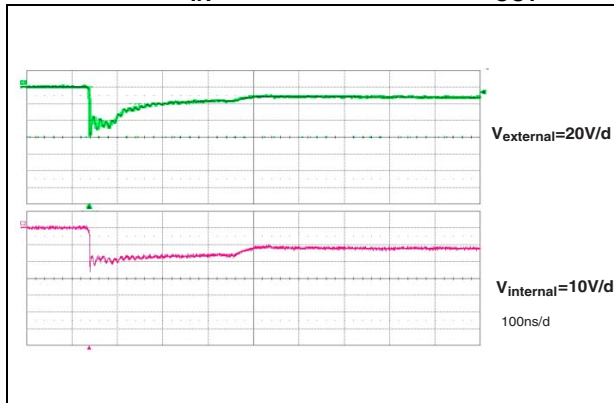
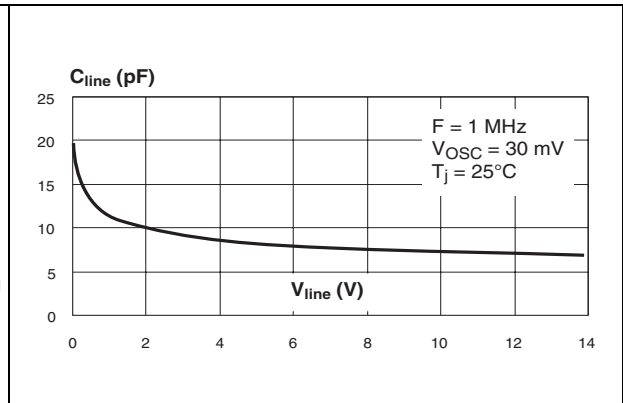

Figure 8. Line capacitance versus applied voltage



2 Application information

Figure 9. Aplac model

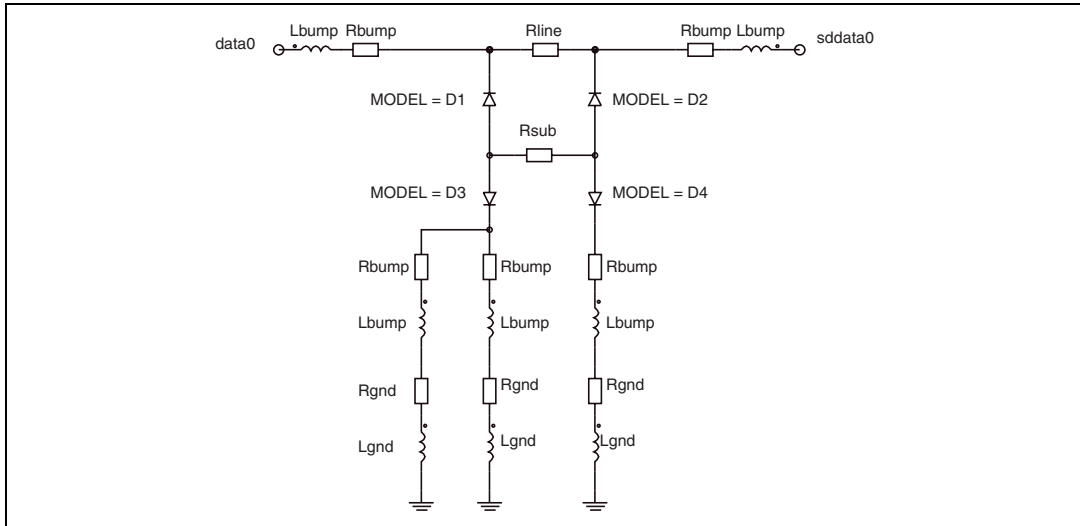
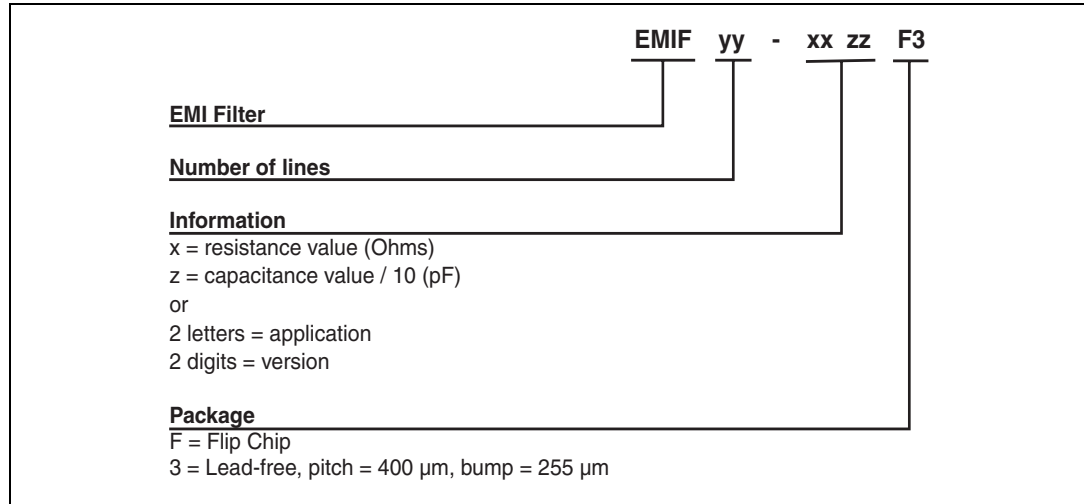

Figure 10. Aplac model variables

<u>Variables</u>	<u>Diode D1</u>	<u>Diode D2</u>	<u>Diode D3</u>	<u>Diode D4</u>
<code>aplacvar Rline 40</code>	<code>BV=7</code>	<code>BV=7</code>	<code>BV=7</code>	<code>BV=7</code>
<code>aplacvar C_d1 14.5p</code>	<code>IBV=1m</code>	<code>IBV=1m</code>	<code>IBV=1m</code>	<code>IBV=1m</code>
<code>aplacvar C_d2 6.5p</code>	<code>CJO=C_d1</code>	<code>CJO=C_d2</code>	<code>CJO=C_d3</code>	<code>CJO=C_d4</code>
<code>aplacvar C_d3 303p</code>	<code>M=0.28</code>	<code>M=0.28</code>	<code>M=0.28</code>	<code>M=0.28</code>
<code>aplacvar C_d4 14.5p</code>	<code>RS=1.13</code>	<code>RS=0.8</code>	<code>RS=0.37</code>	<code>RS=1.13</code>
<code>aplacvar Lbump 43pH</code>	<code>VJ=0.6</code>	<code>VJ=0.6</code>	<code>VJ=0.6</code>	<code>VJ=0.6</code>
<code>aplacvar Rbump 17m</code>	<code>TT=100n</code>	<code>TT=100n</code>	<code>TT=100n</code>	<code>TT=100n</code>
<code>aplacvar Cbump 150f</code>				
<code>aplacvar Lgnd 150pH</code>				
<code>aplacvar Rgnd 10m</code>				
<code>aplacvar Rsub 5</code>				

3 Ordering information scheme

Figure 11. Ordering information scheme



4 Package information

In order to meet environmental requirements, ST offers these devices in ECOPACK® packages. These packages have a lead-free second level interconnect. The category of second level interconnect is marked on the inner box label, in compliance with JEDEC Standard JESD97. The maximum ratings related to soldering conditions are also marked on the inner box label. ECOPACK is an ST trademark. ECOPACK specifications are available at www.st.com.

Figure 12. Package dimensions

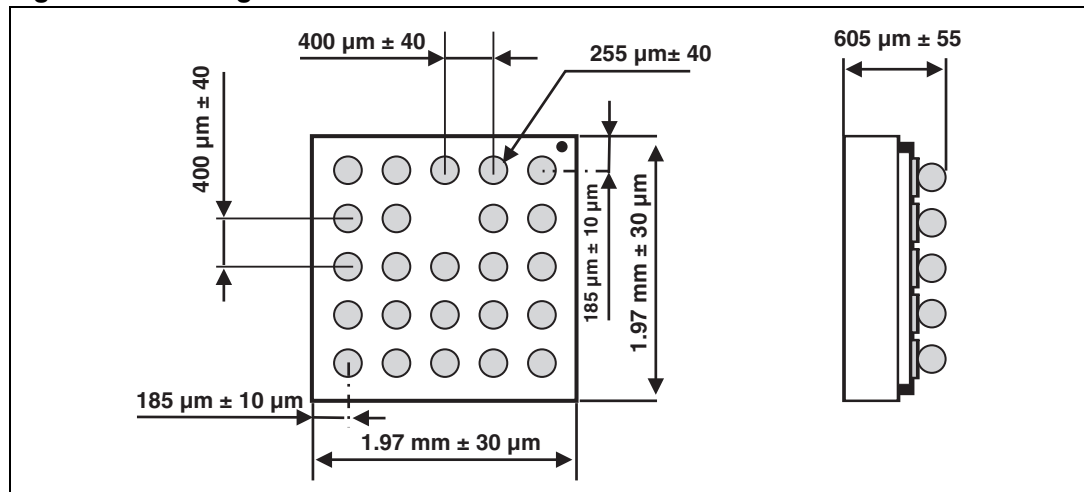

Figure 13. Footprint

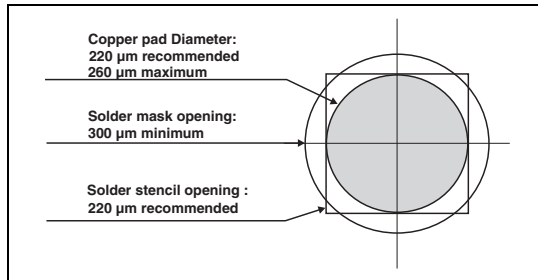

Figure 14. Marking

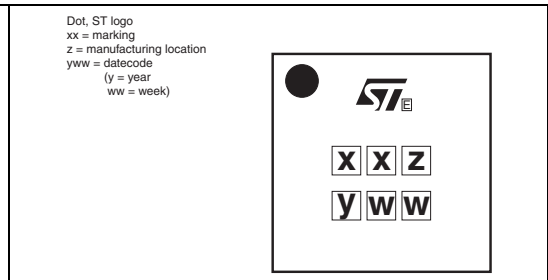
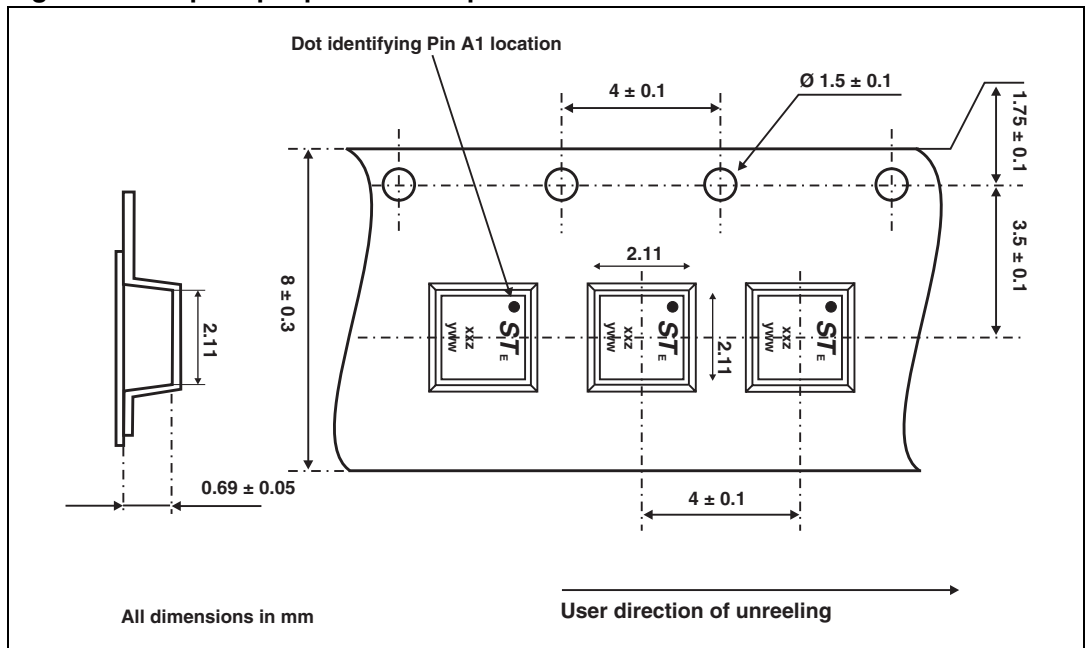

Figure 15. Flip Chip tape and reel specifications



Note:

More information is available in the application note:

AN2348: “STMicroelectronics 400 micro-metre Flip Chip: Package description and recommendation for use”

AN1751: EMI Filters: Recommendations and measurements

5 Ordering information

Table 4. Ordering information

Order code	Marking	Package	Weight	Base qty	Delivery mode
EMIF09-SD01F3	GZ	Flip Chip	5.2 mg	5000	Tape and reel (7")

6 Revision history

Table 5. Document revision history

Date	Revision	Changes
19-Oct-2005	1	Initial release.
09-Feb-2006	2	Tape cavity dimensions added in Figure 13. Other graphics improved.
22-Mar-2006	3	Reformatted to current standard. Typical and maximum values updated for I_{RM} in Electrical characteristics, page 3.
28-Apr-2008	4	Updated ECOPACK statement. Updated Figure 11 , Figure 12 and Figure 15 . Reformatted to current standards.

Please Read Carefully:

Information in this document is provided solely in connection with ST products. STMicroelectronics NV and its subsidiaries ("ST") reserve the right to make changes, corrections, modifications or improvements, to this document, and the products and services described herein at any time, without notice.

All ST products are sold pursuant to ST's terms and conditions of sale.

Purchasers are solely responsible for the choice, selection and use of the ST products and services described herein, and ST assumes no liability whatsoever relating to the choice, selection or use of the ST products and services described herein.

No license, express or implied, by estoppel or otherwise, to any intellectual property rights is granted under this document. If any part of this document refers to any third party products or services it shall not be deemed a license grant by ST for the use of such third party products or services, or any intellectual property contained therein or considered as a warranty covering the use in any manner whatsoever of such third party products or services or any intellectual property contained therein.

UNLESS OTHERWISE SET FORTH IN ST'S TERMS AND CONDITIONS OF SALE ST DISCLAIMS ANY EXPRESS OR IMPLIED WARRANTY WITH RESPECT TO THE USE AND/OR SALE OF ST PRODUCTS INCLUDING WITHOUT LIMITATION IMPLIED WARRANTIES OF MERCHANTABILITY, FITNESS FOR A PARTICULAR PURPOSE (AND THEIR EQUIVALENTS UNDER THE LAWS OF ANY JURISDICTION), OR INFRINGEMENT OF ANY PATENT, COPYRIGHT OR OTHER INTELLECTUAL PROPERTY RIGHT.

UNLESS EXPRESSLY APPROVED IN WRITING BY AN AUTHORIZED ST REPRESENTATIVE, ST PRODUCTS ARE NOT RECOMMENDED, AUTHORIZED OR WARRANTED FOR USE IN MILITARY, AIR CRAFT, SPACE, LIFE SAVING, OR LIFE SUSTAINING APPLICATIONS, NOR IN PRODUCTS OR SYSTEMS WHERE FAILURE OR MALFUNCTION MAY RESULT IN PERSONAL INJURY, DEATH, OR SEVERE PROPERTY OR ENVIRONMENTAL DAMAGE. ST PRODUCTS WHICH ARE NOT SPECIFIED AS "AUTOMOTIVE GRADE" MAY ONLY BE USED IN AUTOMOTIVE APPLICATIONS AT USER'S OWN RISK.

Resale of ST products with provisions different from the statements and/or technical features set forth in this document shall immediately void any warranty granted by ST for the ST product or service described herein and shall not create or extend in any manner whatsoever, any liability of ST.

ST and the ST logo are trademarks or registered trademarks of ST in various countries.

Information in this document supersedes and replaces all information previously supplied.

The ST logo is a registered trademark of STMicroelectronics. All other names are the property of their respective owners.

© 2008 STMicroelectronics - All rights reserved

STMicroelectronics group of companies

Australia - Belgium - Brazil - Canada - China - Czech Republic - Finland - France - Germany - Hong Kong - India - Israel - Italy - Japan - Malaysia - Malta - Morocco - Singapore - Spain - Sweden - Switzerland - United Kingdom - United States of America

www.st.com

Данный компонент на территории Российской Федерации

Вы можете приобрести в компании MosChip.

Для оперативного оформления запроса Вам необходимо перейти по данной ссылке:

<http://moschip.ru/get-element>

Вы можете разместить у нас заказ для любого Вашего проекта, будь то серийное производство или разработка единичного прибора.

В нашем ассортименте представлены ведущие мировые производители активных и пассивных электронных компонентов.

Нашей специализацией является поставка электронной компонентной базы двойного назначения, продукции таких производителей как XILINX, Intel (ex.ALTERA), Vicor, Microchip, Texas Instruments, Analog Devices, Mini-Circuits, Amphenol, Glenair.

Сотрудничество с глобальными дистрибьюторами электронных компонентов, предоставляет возможность заказывать и получать с международных складов практически любой перечень компонентов в оптимальные для Вас сроки.

На всех этапах разработки и производства наши партнеры могут получить квалифицированную поддержку опытных инженеров.

Система менеджмента качества компании отвечает требованиям в соответствии с ГОСТ Р ИСО 9001, ГОСТ РВ 0015-002 и ЭС РД 009

Офис по работе с юридическими лицами:

105318, г.Москва, ул.Щербаковская д.3, офис 1107, 1118, ДЦ «Щербаковский»

Телефон: +7 495 668-12-70 (многоканальный)

Факс: +7 495 668-12-70 (доб.304)

E-mail: info@moschip.ru

Skype отдела продаж:

moschip.ru

moschip.ru_4

moschip.ru_6

moschip.ru_9