



Features/Benefits

- Compact design
- Low actuation force
- Detect mechanical movement
- Left and right options
- Right angle options

Typical Applications

- Computer peripherals
- Office equipment
- Consumer electronics
- Appliances
- Audio and visual equipment

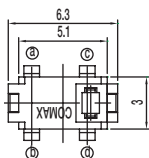

PART NUMBER	PACKAGING	SCHEMATIC
DS-02005	1,000 pieces	1P-1T

Specifications

CONTACT ARRANGEMENT: SPST, NO
 CONTACT RATING: 100mA @ 30 VDC
 OPERATING LIFE: 50,000 cycles
 OPERATING FORCE: 50 gf max.
 PRE-TRAVEL: 0.7 mm
 TOTAL TRAVEL: 2.6 mm
 INITIAL CONTACT RESISTANCE: 1 Ω max.
 INSULATION RESISTANCE: 100 M Ω min. @ 100 VDC 60 sec.
 DIELECTRIC STRENGTH: 100 V AC (50-60Hz) 60 sec.
 OPERATING TEMPERATURE: -40°C to +85°C.

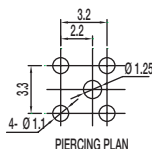
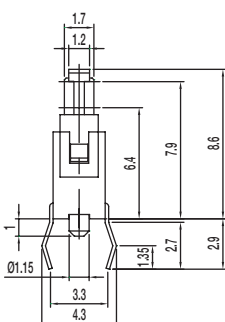
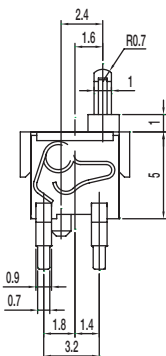

Materials

KNOB: PA
 COVER: PA
 SPRING: Gold plated, copper alloy
 HOUSING: PA
 TERMINAL: Silver plated, copper alloy

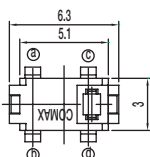

PART NUMBER	PACKAGING	SCHEMATIC
DS-02005 (30)	1,000 pieces	1P-1T

Specifications

CONTACT ARRANGEMENT: SPST, NO
 CONTACT RATING: 100mA @ 30 VDC
 OPERATING LIFE: 50,000 cycles
 OPERATING FORCE: 30 gf max.
 PRE-TRAVEL: 0.7 mm
 TOTAL TRAVEL: 2.2 mm
 INITIAL CONTACT RESISTANCE: 1 Ω max.
 INSULATION RESISTANCE: 100 M Ω min. @ 100 VDC 60 sec.
 DIELECTRIC STRENGTH: 100 V AC (50-60Hz) 60 sec.
 OPERATING TEMPERATURE: -40°C to +85°C.

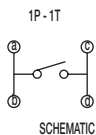
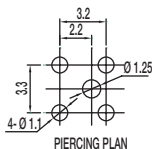
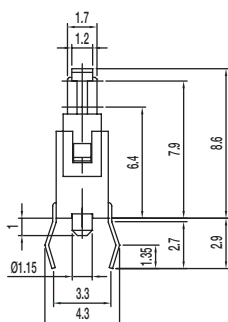
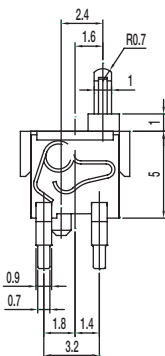

Materials

KNOB: PA
 COVER: PA
 SPRING: Gold plated, copper alloy
 HOUSING: PA
 TERMINAL: Silver plated, copper alloy

DS Series Detect Switch

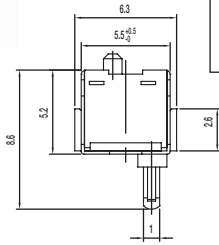

PART NUMBER	PACKAGING	SCHEMATIC
DS-02005-A	1,000 pieces	1P-1T N.O.

Specifications

CONTACT ARRANGEMENT: SPST, NO
 CONTACT RATING: 100mA @ 30 VDC
 OPERATING LIFE: 50,000 cycles
 OPERATING FORCE: 50 gf max.
 PRE-TRAVEL: 0.7 mm
 TOTAL TRAVEL: 2.6 mm
 INITIAL CONTACT RESISTANCE: 1 Ω max.
 INSULATION RESISTANCE: 100 M Ω min. @ 100 VDC 60 sec.
 DIELECTRIC STRENGTH: 100 V AC (50-60Hz) 60 sec.
 OPERATING TEMPERATURE: -40°C to +85°C.

Materials

KNOB: PA
 COVER: PA
 SPRING: Gold plated, copper alloy
 HOUSING: PA
 TERMINAL: Silver plated, copper alloy

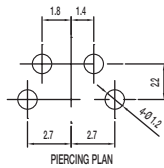
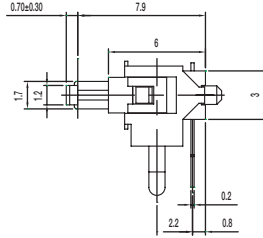
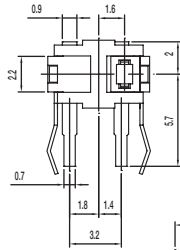

PART NUMBER	PACKAGING	SCHEMATIC
DS-21805	2,500 pieces	 C D A B N.O.

Specifications

CONTACT ARRANGEMENT: SPDT
 CONTACT RATING: 5mA @ 5 VDC
 OPERATING LIFE: 100,000 cycles
 OPERATING FORCE: 36 gf
 TOTAL TRAVEL: 2.20 mm
 INITIAL CONTACT RESISTANCE: 1 Ω max.
 INSULATION RESISTANCE: 100 M Ω min. @ 100 VDC 60 sec.
 DIELECTRIC STRENGTH: 100 V AC (50-60Hz) 60 sec.
 OPERATING TEMPERATURE: -20°C to +70°C.

Materials

KNOB: POM
 COVER: PA46
 SPRING: Silver plated
 HOUSING: PPS
 TERMINAL: Silver plated

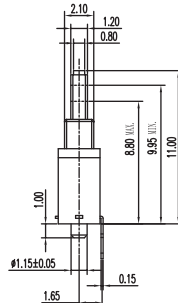
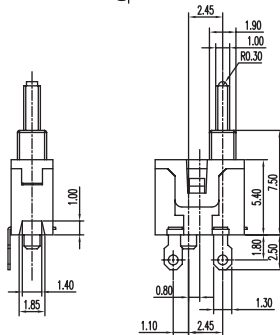
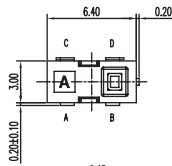

D

Detect



PART NUMBER	PACKAGING	SCHEMATIC
DS-203-A	2,500 pieces	 1P - 1T N.O.

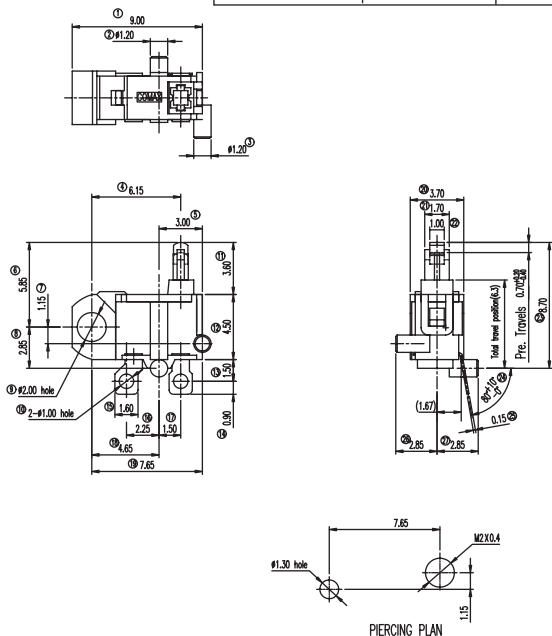

Specifications

CONTACT ARRANGEMENT: SPST
CONTACT RATING: 100mA @ 30 VDC
OPERATING LIFE: 50,000 cycles
OPERATING FORCE: 36 gf
PRE TRAVEL: 0.70 +0.20/-0.40 mm
INITIAL CONTACT RESISTANCE: 1 Ω max.
INSULATION RESISTANCE: 50 M Ω min. @ 250 VDC 60 sec.
DIELECTRIC STRENGTH: 250 V AC (50-60Hz) 60 sec.
OPERATING TEMPERATURE: -20°C to +70°C.

Materials

KNOB: POM
COVER: PA
SPRING: Gold plated
HOUSING: PA
TERMINAL: Silver plated



PART NUMBER	PACKAGING	SCHEMATIC
DS-040-02	1,000 pieces	 1P-1T N.O.

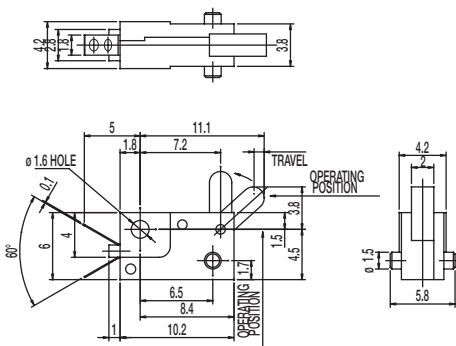

Specifications

CONTACT ARRANGEMENT: SPST, NO
CONTACT RATING: 0.1A @ 16 VDC
OPERATING LIFE: 20,000 cycles
OPERATING FORCE: 30 \pm 15 gf
TRAVEL: 0.90 \pm 0.20 mm
INITIAL CONTACT RESISTANCE: 40 m Ω max.
INSULATION RESISTANCE: 100 M Ω min. @ 250 VDC 60 sec.
DIELECTRIC STRENGTH: 250 V AC (50-60Hz) 60 sec.
OPERATING TEMPERATURE: -20°C to +70°C.

Materials

LEVER: POM
CASE: PBT
COVER: PC

DS Series Detect Switch



PART NUMBER	PACKAGING	SCHEMATIC
DS-080	1,000 pieces	

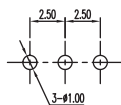
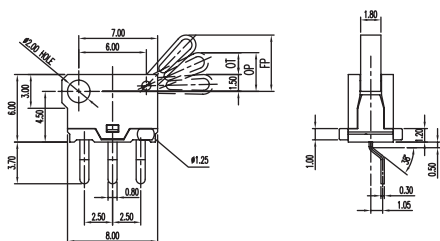

PIERCING PLAN

Specifications

CONTACT ARRANGEMENT: SPDT
 CONTACT RATING: 100mA @ 30 VDC
 OPERATING LIFE: 20,000 cycles
 OPERATING FORCE: 30 ± 20 gf
 OVER TRAVEL: 2.0 ± 0.40 mm
 INITIAL CONTACT RESISTANCE: 200 m Ω max.
 INSULATION RESISTANCE: 10 M Ω min. @ 250 VDC 60 sec.
 DIELECTRIC STRENGTH: 250 V AC (50-60Hz) 60 sec.
 OPERATING TEMPERATURE: -20°C to +70°C.

Materials

KNOB: POM
 COVER: PA46
 SLIDER: PBT
 HOUSING: PA46
 TERMINAL: Silver plated



PART NUMBER	PACKAGING	SCHEMATIC
DS-080-C PA	1,000 pieces	

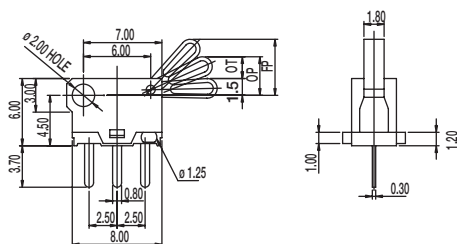
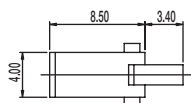

PIERCING PLAN

Specifications

CONTACT ARRANGEMENT: SPDT
 CONTACT RATING: 100mA @ 30 VDC
 OPERATING LIFE: 20,000 cycles
 OPERATING FORCE: 30 ± 20 gf
 OVER TRAVEL: 2.0 ± 0.40 mm
 INITIAL CONTACT RESISTANCE: 200 m Ω max.
 INSULATION RESISTANCE: 10 M Ω min. @ 250 VDC 60 sec.
 DIELECTRIC STRENGTH: 250 V AC (50-60Hz) 60 sec.
 OPERATING TEMPERATURE: -20°C to +70°C.

Materials

KNOB: POM
 COVER: PA46
 SLIDER: PBT
 HOUSING: PA46
 TERMINAL: Silver plated



D

Detect



PART NUMBER	PACKAGING	SCHEMATIC
DS-09005-02 BK	500 pieces	 N.O.

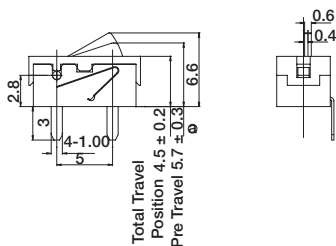
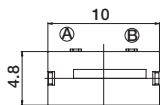

Specifications

CONTACT ARRANGEMENT: SPST
 CONTACT RATING: 1mA @ 5 VDC
 OPERATING LIFE: 100,000 cycles
 OPERATING FORCE: 50 gf max.
 TOTAL TRAVEL: 4.5 ± 0.2 mm
 INITIAL CONTACT RESISTANCE: 500 m Ω max.
 INSULATION RESISTANCE: 100 M Ω min. @ 500 VDC 60 sec.
 DIELECTRIC STRENGTH: 500 V AC (50-60Hz) 60 sec.
 OPERATING TEMPERATURE: -20°C to $+70^{\circ}\text{C}$.

Materials

LEVER: POM
 COVER: PA
 HOUSING: PA
 TERMINAL: Silver plated



PART NUMBER	PACKAGING	SCHEMATIC
DS-09005-02 RP	500 pieces	 N.O.

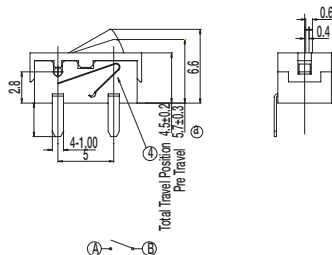
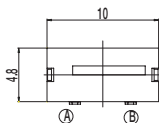

Specifications

CONTACT ARRANGEMENT: SPST
 CONTACT RATING: 1mA @ 5 VDC
 OPERATING LIFE: 100,000 cycles
 OPERATING FORCE: 50 gf max.
 TOTAL TRAVEL: 4.5 ± 0.2 mm
 INITIAL CONTACT RESISTANCE: 500 m Ω max.
 INSULATION RESISTANCE: 100 M Ω min. @ 500 VDC 60 sec.
 DIELECTRIC STRENGTH: 500 V AC (50-60Hz) 60 sec.
 OPERATING TEMPERATURE: -20°C to $+70^{\circ}\text{C}$.

Materials

LEVER: POM
 COVER: PA
 HOUSING: PA
 TERMINAL: Silver plated



Detect

Данный компонент на территории Российской Федерации

Вы можете приобрести в компании MosChip.

Для оперативного оформления запроса Вам необходимо перейти по данной ссылке:

<http://moschip.ru/get-element>

Вы можете разместить у нас заказ для любого Вашего проекта, будь то серийное производство или разработка единичного прибора.

В нашем ассортименте представлены ведущие мировые производители активных и пассивных электронных компонентов.

Нашей специализацией является поставка электронной компонентной базы двойного назначения, продукции таких производителей как XILINX, Intel (ex.ALTERA), Vicor, Microchip, Texas Instruments, Analog Devices, Mini-Circuits, Amphenol, Glenair.

Сотрудничество с глобальными дистрибьюторами электронных компонентов, предоставляет возможность заказывать и получать с международных складов практически любой перечень компонентов в оптимальные для Вас сроки.

На всех этапах разработки и производства наши партнеры могут получить квалифицированную поддержку опытных инженеров.

Система менеджмента качества компании отвечает требованиям в соответствии с ГОСТ Р ИСО 9001, ГОСТ РВ 0015-002 и ЭС РД 009

Офис по работе с юридическими лицами:

105318, г.Москва, ул.Щербаковская д.3, офис 1107, 1118, ДЦ «Щербаковский»

Телефон: +7 495 668-12-70 (многоканальный)

Факс: +7 495 668-12-70 (доб.304)

E-mail: info@moschip.ru

Skype отдела продаж:

moschip.ru

moschip.ru_4

moschip.ru_6

moschip.ru_9