

FEATURES

- **Period Range: 1ms to 9.5 Hours**
- **Timing Reset by Power-On or Reset Input**
- Configured with 1 to 3 Resistors
- <1.5% Maximum Frequency Error
- Programmable Output Polarity
- 2.25V to 5.5V Single Supply Operation
- 55µA to 80µA Supply Current (2ms to 9.5hr Clock Period)
- 500µs Start-Up Time
- CMOS Output Driver Sources/Sinks 20mA
- -55°C to 125°C Operating Temperature Range
- Available in Low Profile (1mm) SOT-23 (ThinSOT™) and 2mm × 3mm DFN Packages

APPLICATIONS

- Power-On Reset Timer
- Long Time One Shot
- “Heartbeat” Timers
- Watchdog Timers
- Periodic “Wake-Up” Call
- High Vibration, High Acceleration Environments

LT, LT, LTC, LTM, Linear Technology, TimerBlox and the Linear logo are registered trademarks and ThinSOT is a trademark of Linear Technology Corporation. All other trademarks are the property of their respective owners.

DESCRIPTION

The **LTC®6995** is a silicon oscillator with a programmable period range of 1.024ms to 9.54 hours (29.1µHz to 977Hz), specifically intended for long duration timing events. The LTC6995 is part of the TimerBlox® family of versatile silicon timing devices.

A single resistor, R_{SET} , programs the LTC6995’s internal master oscillator frequency. The output clock period is determined by this master oscillator and an internal frequency divider, N_{DIV} , programmable to eight settings from 1 to 2^{21} .

$$t_{OUT} = \frac{N_{DIV} \cdot R_{SET}}{50k\Omega} \cdot 1.024ms, N_{DIV} = 1, 8, 64, \dots, 2^{21}$$

When oscillating, the LTC6995 generates a 50% duty cycle square wave output. A reset function is provided to stop the master oscillator and clear internal dividers. Removing reset initiates a full output clock cycle which is useful for programmable power-on reset and watchdog timer applications.

The LTC6995 has two versions of reset functionality. The reset input is active high for the LTC6995-1 and active low for the LTC6995-2. The polarity of the output when reset is selectable for both versions.

RST/RST	POLARITY	OUTPUT (OSCILLATOR START STATE)	
		LTC6995-1	LTC6995-2
0	0	Oscillating (Low)	0 (Reset)
1	0	0 (Reset)	Oscillating (Low)
0	1	Oscillating (High)	1 (Reset)
1	1	1 (Reset)	Oscillating (High)

TYPICAL APPLICATION

Active Low Power-On Reset Timer



699512 TA01

699512fa

LTC6995-1/LTC6995-2

ABSOLUTE MAXIMUM RATINGS (Note 1)

Supply Voltage (V^+) to GND	6V
Maximum Voltage on Any Pin	$(GND - 0.3V) \leq V_{PIN} \leq (V^+ + 0.3V)$
Operating Temperature Range (Note 2)	
LTC6995C	-40°C to 85°C
LTC6995I	-40°C to 85°C
LTC6995H	-40°C to 125°C
LTC6995MP	-55°C to 125°C

Specified Temperature Range (Note 3)	
LTC6995C	0°C to 70°C
LTC6995I	-40°C to 85°C
LTC6995H	-40°C to 125°C
LTC6995MP	-55°C to 125°C
Junction Temperature	150°C
Storage Temperature Range	-65°C to 150°C
Lead Temperature (Soldering, 10 sec)	
S6 Package	300°C

PIN CONFIGURATION



ORDER INFORMATION

Lead Free Finish

TAPE AND REEL (MINI)	TAPE AND REEL	PART MARKING*	PACKAGE DESCRIPTION	SPECIFIED TEMPERATURE RANGE
LTC6995CDCB-1#TRMPBF	LTC6995CDCB-1#TRPBF	LGJM	6-Lead (2mm × 3mm) Plastic DFN	0°C to 70°C
LTC6995IDCB-1#TRMPBF	LTC6995IDCB-1#TRPBF	LGJM	6-Lead (2mm × 3mm) Plastic DFN	-40°C to 85°C
LTC6995HDCB-1#TRMPBF	LTC6995HDCB-1#TRPBF	LGJM	6-Lead (2mm × 3mm) Plastic DFN	-40°C to 125°C
LTC6995CDCB-2#TRMPBF	LTC6995CDCB-2#TRPBF	LGJP	6-Lead (2mm × 3mm) Plastic DFN	0°C to 70°C
LTC6995IDCB-2#TRMPBF	LTC6995IDCB-2#TRPBF	LGJP	6-Lead (2mm × 3mm) Plastic DFN	-40°C to 85°C
LTC6995HDCB-2#TRMPBF	LTC6995HDCB-2#TRPBF	LGJP	6-Lead (2mm × 3mm) Plastic DFN	-40°C to 125°C
LTC6995CS6-1#TRMPBF	LTC6995CS6-1#TRPBF	LTGJN	6-Lead Plastic TSOT-23	0°C to 70°C
LTC6995IS6-1#TRMPBF	LTC6995IS6-1#TRPBF	LTGJN	6-Lead Plastic TSOT-23	-40°C to 85°C
LTC6995HS6-1#TRMPBF	LTC6995HS6-1#TRPBF	LTGJN	6-Lead Plastic TSOT-23	-40°C to 125°C
LTC6995MPS6-1#TRMPBF	LTC6995MPS6-1#TRPBF	LTGJN	6-Lead Plastic TSOT-23	-55°C to 125°C
LTC6995CS6-2#TRMPBF	LTC6995CS6-2#TRPBF	LTGJQ	6-Lead Plastic TSOT-23	0°C to 70°C
LTC6995IS6-2#TRMPBF	LTC6995IS6-2#TRPBF	LTGJQ	6-Lead Plastic TSOT-23	-40°C to 85°C
LTC6995HS6-2#TRMPBF	LTC6995HS6-2#TRPBF	LTGJQ	6-Lead Plastic TSOT-23	-40°C to 125°C
LTC6995MPS6-2#TRMPBF	LTC6995MPS6-2#TRPBF	LTGJQ	6-Lead Plastic TSOT-23	-55°C to 125°C

TRM = 500 pieces. *Temperature grades are identified by a label on the shipping container.

Consult LTC Marketing for parts specified with wider operating temperature ranges.

Consult LTC Marketing for information on lead based finish parts.

For more information on lead free part marking, go to: <http://www.linear.com/leadfree/>

For more information on tape and reel specifications, go to: <http://www.linear.com/tapeandree/>

699512fa

ELECTRICAL CHARACTERISTICS The ● denotes the specifications which apply over the full operating temperature range, otherwise specifications are at $T_A = 25^\circ\text{C}$. Test conditions are $V^+ = 2.25\text{V}$ to 5.5V , $R_{ST} = 0\Omega$ for LTC6995-1, $R_{ST} = V^+$ for LTC6995-2, $\text{DIVCODE} = 0$ to 15 ($N_{\text{DIV}} = 1$ to 2^{21}), $R_{\text{SET}} = 50\text{k}$ to 800k , $R_{\text{LOAD}} = 5\text{k}$, $C_{\text{LOAD}} = 5\text{pF}$ unless otherwise noted.

SYMBOL	PARAMETER	CONDITIONS	MIN	TYP	MAX	UNITS
t_{OUT}	Output Clock Period		1.024m		34,360	Seconds
f_{OUT}	Output Frequency		29.1 μ		977	Hz
Δf_{OUT}	Frequency Accuracy (Note 4)	$29.1\mu\text{Hz} \leq f_{\text{OUT}} \leq 977\text{Hz}$		± 0.8	± 1.5 ± 2.2	% %
$\Delta f_{\text{OUT}}/\Delta T$	Frequency Drift Over Temperature			± 0.005		%/ $^\circ\text{C}$
$\Delta f_{\text{OUT}}/\Delta V^+$	Frequency Drift Over Supply	$V^+ = 4.5\text{V}$ to 5.5V $V^+ = 2.25\text{V}$ to 4.5V		0.23 0.06	0.55 0.16	%/ V %/V
	Long-Term Frequency Stability	(Note 11)		90		ppm/ $\sqrt{\text{kHr}}$
	Period Jitter (Note 10)	$N_{\text{DIV}} = 1$ $N_{\text{DIV}} = 8$		15 7		ppm $_{\text{RMS}}$ ppm $_{\text{RMS}}$
BW	Frequency Modulation Bandwidth			$0.4 \cdot f_{\text{OUT}}$		Hz
t_s	Frequency Change Settling Time (Note 9)			1		Cycle

Analog Inputs

V_{SET}	Voltage at SET Pin		●	0.97	1.00	1.03	V
$\Delta V_{\text{SET}}/\Delta T$	V_{SET} Drift Over Temperature		●		± 75		$\mu\text{V}/^\circ\text{C}$
R_{SET}	Frequency-Setting Resistor		●	50		800	$\text{k}\Omega$
V_{DIV}	DIV Pin Voltage		●	0		V^+	V
$\Delta V_{\text{DIV}}/\Delta V^+$	DIV Pin Valid Code Range (Note 5)	Deviation from Ideal $V_{\text{DIV}}/V^+ = (\text{DIVCODE} + 0.5)/16$	●			± 1.5	%
	DIV Pin Input Current		●			± 10	nA

Power Supply

V^+	Operating Supply Voltage Range		●	2.25		5.5	V
	Power-On Reset Voltage		●			1.95	V
I_s	Supply Current	$R_L = \infty$, $R_{\text{SET}} = 50\text{k}$	$V^+ = 5.5\text{V}$ $V^+ = 2.25\text{V}$	● ●	135 105	170 135	μA μA
		$R_L = \infty$, $R_{\text{SET}} = 100\text{k}$	$V^+ = 5.5\text{V}$ $V^+ = 2.25\text{V}$	● ●	100 80	130 105	μA μA
		$R_L = \infty$, $R_{\text{SET}} = 800\text{k}$	$V^+ = 5.5\text{V}$ $V^+ = 2.25\text{V}$	● ●	65 55	100 85	μA μA
		$R_L = \infty$, $I_{\text{SET}} = 0\mu\text{A}$	$V^+ = 5.5\text{V}$ $V^+ = 2.25\text{V}$		60 52		μA μA

LTC6995-1/LTC6995-2

ELECTRICAL CHARACTERISTICS The ● denotes the specifications which apply over the full operating temperature range, otherwise specifications are at $T_A = 25^\circ\text{C}$. Test conditions are $V^+ = 2.25\text{V}$ to 5.5V , $\text{RST} = 0\text{V}$ for LTC6995-1, $\text{RST} = V^+$ for LTC6995-2, $\text{DIVCODE} = 0$ to 15 ($N_{\text{DIV}} = 1$ to 2^{15}), $R_{\text{SET}} = 50\text{k}$ to 800k , $R_{\text{LOAD}} = \infty$, $C_{\text{LOAD}} = 5\text{pF}$ unless otherwise noted.

SYMBOL	PARAMETER	CONDITIONS	MIN	TYP	MAX	UNITS	
Digital I/O							
	RST Pin Input Capacitance			2.5		pF	
	RST Pin Input Current	$\text{RST} = 0\text{V}$ to V^+			± 10	nA	
V_{IH}	High Level RST Pin Input Voltage	(Note 6)	●	$0.7 \cdot V^+$		V	
V_{IL}	Low Level RST Pin Input Voltage	(Note 6)	●		$0.3 \cdot V^+$	V	
$I_{\text{OUT(MAX)}}$	Output Current	$V^+ = 2.7\text{V}$ to 5.5V		± 20		mA	
V_{OH}	High Level Output Voltage (Note 7)	$V^+ = 5.5\text{V}$ $I_{\text{OUT}} = -1\text{mA}$ $I_{\text{OUT}} = -16\text{mA}$	● ●	5.45 4.84	5.48 5.15	V V	
		$V^+ = 3.3\text{V}$ $I_{\text{OUT}} = -1\text{mA}$ $I_{\text{OUT}} = -10\text{mA}$	● ●	3.24 2.75	3.27 2.99	V V	
		$V^+ = 2.25\text{V}$ $I_{\text{OUT}} = -1\text{mA}$ $I_{\text{OUT}} = -8\text{mA}$	● ●	2.17 1.58	2.21 1.88	V V	
V_{OL}	Low Level Output Voltage (Note 7)	$V^+ = 5.5\text{V}$ $I_{\text{OUT}} = 1\text{mA}$ $I_{\text{OUT}} = 16\text{mA}$	● ●		0.02 0.26	0.04 0.54	V V
		$V^+ = 3.3\text{V}$ $I_{\text{OUT}} = 1\text{mA}$ $I_{\text{OUT}} = 10\text{mA}$	● ●		0.03 0.22	0.05 0.46	V V
		$V^+ = 2.25\text{V}$ $I_{\text{OUT}} = 1\text{mA}$ $I_{\text{OUT}} = 8\text{mA}$	● ●		0.03 0.26	0.07 0.54	V V
t_{RST}	Reset Propagation Delay	$V^+ = 5.5\text{V}$		16		ns	
		$V^+ = 3.3\text{V}$		24		ns	
		$V^+ = 2.25\text{V}$		40		ns	
t_{WIDTH}	Minimum Input Pulse Width	$V^+ = 3.3\text{V}$		5		ns	
t_{r}	Output Rise Time (Note 8)	$V^+ = 5.5\text{V}$		1.1		ns	
		$V^+ = 3.3\text{V}$		1.7		ns	
		$V^+ = 2.25\text{V}$		2.7		ns	
t_{f}	Output Fall Time (Note 8)	$V^+ = 5.5\text{V}$		1.0		ns	
		$V^+ = 3.3\text{V}$		1.6		ns	
		$V^+ = 2.25\text{V}$		2.4		ns	

Note 1: Stresses beyond those listed under Absolute Maximum Ratings may cause permanent damage to the device. Exposure to any Absolute Maximum Rating condition for extended periods may affect device reliability and lifetime.

Note 2: The LTC6995C is guaranteed functional over the operating temperature range of -40°C to 85°C .

Note 3: The LTC6995C is guaranteed to meet specified performance from 0°C to 70°C . The LTC6995C is designed, characterized and expected to meet specified performance from -40°C to 85°C but it is not tested or QA sampled at these temperatures. The LTC6995I is guaranteed to meet specified performance from -40°C to 85°C . The LTC6995H is guaranteed to meet specified performance from -40°C to 125°C . The LTC6995MP is guaranteed to meet specified performance from -55°C to 125°C .

Note 4: Frequency accuracy is defined as the deviation from the f_{OUT} equation, assuming R_{SET} is used to program the frequency.

Note 5: See Operation section, Table 1 and Figure 2 for a full explanation of how the DIV pin voltage selects the value of DIVCODE.

Note 6: The RST pin has hysteresis to accommodate slow rising or falling signals. The threshold voltages are proportional to V^+ . Typical values can be estimated at any supply voltage using $V_{\text{RST(RISING)}} \approx 0.55 \cdot V^+ + 185\text{mV}$ and $V_{\text{RST(FALLING)}} \approx 0.48 \cdot V^+ - 155\text{mV}$.

Note 7: To conform to the Logic IC Standard, current out of a pin is arbitrarily given a negative value.

Note 8: Output rise and fall times are measured between the 10% and the 90% power supply levels with 5pF output load. These specifications are based on characterization.

Note 9: Settling time is the amount of time required for the output to settle within $\pm 1\%$ of the final frequency after a $0.5\times$ or $2\times$ change in I_{SET} .

Note 10: Jitter is the ratio of the deviation of the period to the mean of the period. This specification is based on characterization and is not 100% tested.

Note 11: Long-term drift of silicon oscillators is primarily due to the movement of ions and impurities within the silicon and is tested at 30°C under otherwise nominal operating conditions. Long-term drift is specified as $\text{ppm}/\sqrt{\text{kHr}}$ due to the typically nonlinear nature of the drift. To calculate drift for a set time period, translate that time into thousands of hours, take the square root and multiply by the typical drift number. For instance, a year is 8.77kHr and would yield a drift of 266ppm at $90\text{ppm}/\sqrt{\text{kHr}}$. Drift without power applied to the device may be approximated as 1/10th of the drift with power, or 9ppm/ $\sqrt{\text{kHr}}$ for a $90\text{ppm}/\sqrt{\text{kHr}}$ device.

699512fa

TYPICAL PERFORMANCE CHARACTERISTICS

$V^+ = 3.3V$, $R_{SET} = 200k$, $T_A = 25^\circ C$ unless otherwise noted.



699512 G01

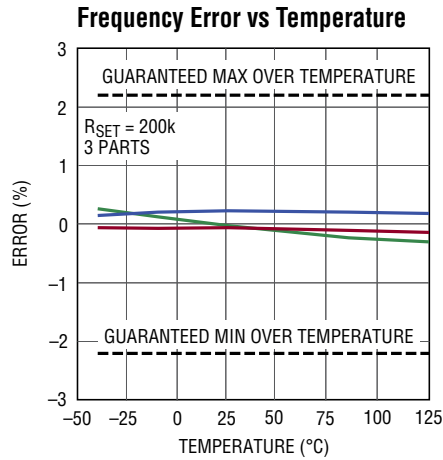

699512 G02

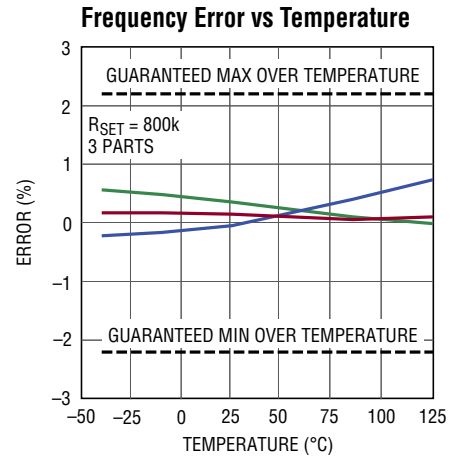

699512 G03



699512 G04



699512 G05

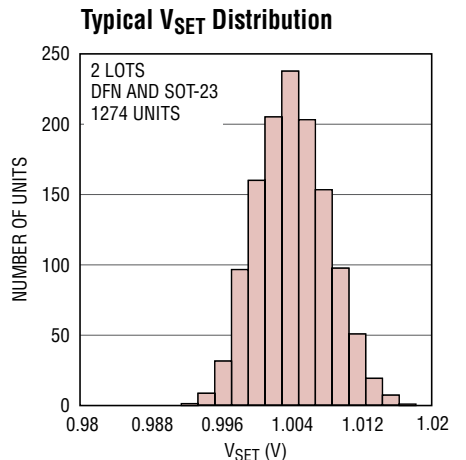

699512 G06



699512 G07



699512 G08

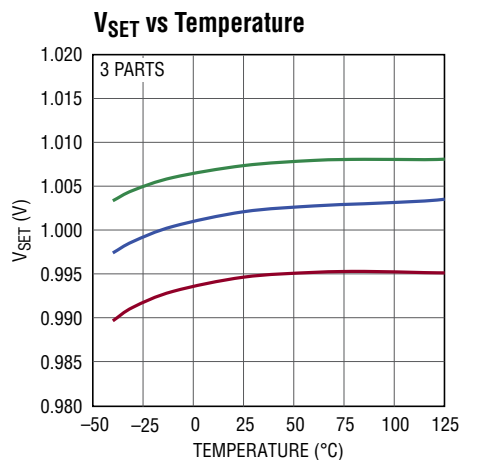

699512 G09

TYPICAL PERFORMANCE CHARACTERISTICS

$V^+ = 3.3V$, $R_{SET} = 200k$, $T_A = 25^\circ C$ unless otherwise noted.

Supply Current vs Supply Voltage



699512 G10

Supply Current vs Temperature

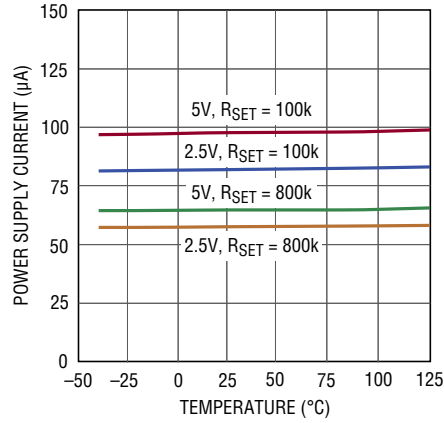

699512 G11

Supply Current vs RST Pin Voltage

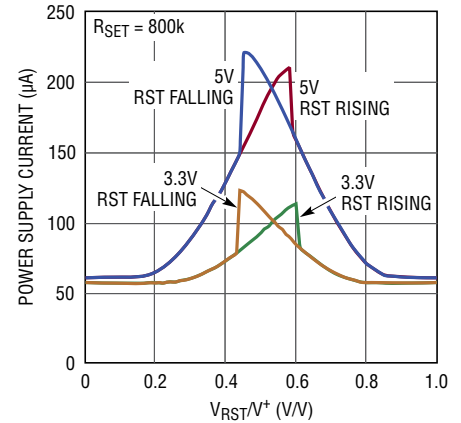

699512 G12

Supply Current vs RSET

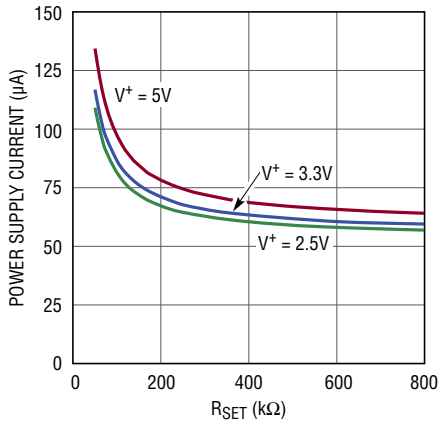

699512 G13

Typical I_{SET} Current Limit vs V^+

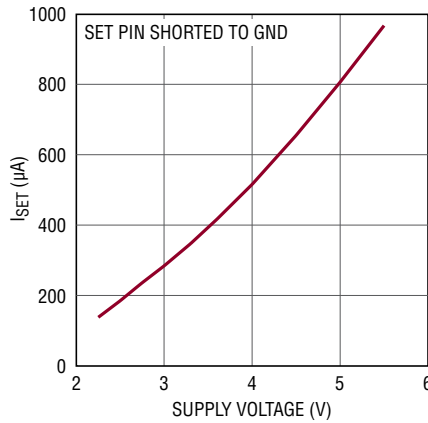

699512 G14

RST Threshold Voltage vs Supply Voltage

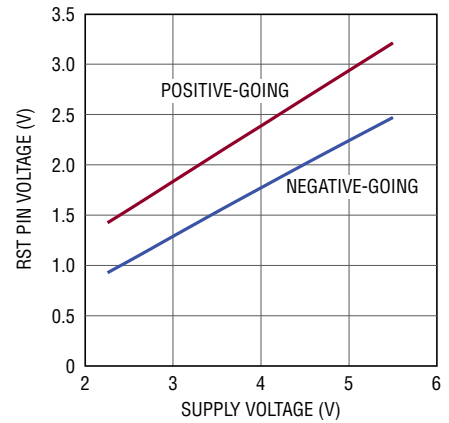

699512 G15

Reset Propagation Delay (t_{RST}) vs Supply Voltage

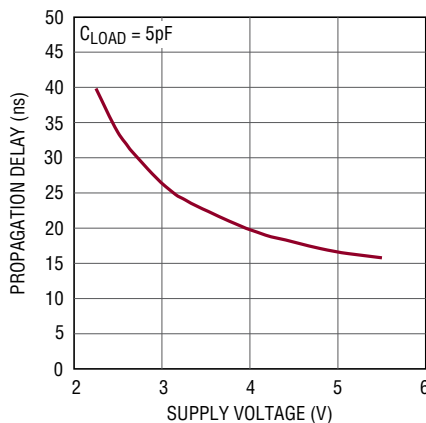

699512 G16

Rise and Fall Time vs Supply Voltage

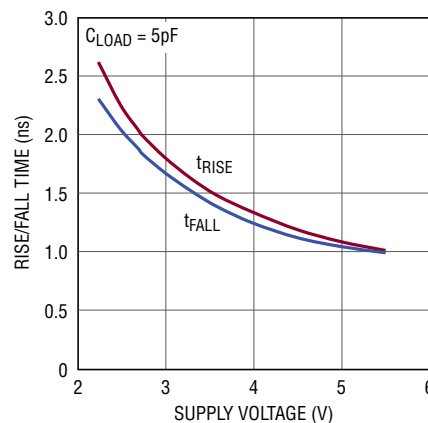

699512 G17

Typical Frequency Error vs Time (Long-Term Drift)

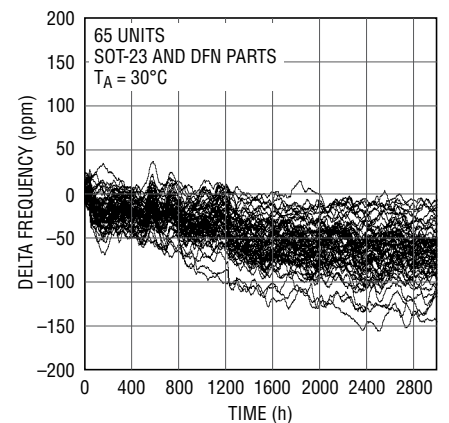

699512 G18

TYPICAL PERFORMANCE CHARACTERISTICS

$V^+ = 3.3V$, $R_{SET} = 200k$, $T_A = 25^\circ C$ unless otherwise noted.



PIN FUNCTIONS (DCB/S6)

V⁺ (Pin 1/Pin 5): Supply Voltage (2.25V to 5.5V). This supply should be kept free from noise and ripple. It should be bypassed directly to the GND pin with a 0.1μF capacitor.

DIV (Pin 2/Pin 4): Programmable Divider and Polarity Input. An internal A/D converter (referenced to V⁺) monitors the DIV pin voltage (V_{DIV}) to determine a 4-bit result (DIVCODE). V_{DIV} may be generated by a resistor divider between V⁺ and GND. Use 1% resistors to ensure an accurate result. The DIV pin and resistors should be shielded from the OUT pin or any other traces that have fast edges. Limit the capacitance on the DIV pin to less than 100pF so that V_{DIV} settles quickly. The MSB of DIVCODE (POL) determines the polarity of the OUT pin.

SET (Pin 3/Pin 3): Frequency-Setting Input. The voltage on the SET pin (V_{SET}) is regulated to 1V above GND. The amount of current sourced from the SET pin (I_{SET}) programs the master oscillator frequency. The I_{SET} current range is 1.25μA to 20μA. The output oscillation will stop if I_{SET} drops below approximately 500nA. A resistor connected between SET and GND is the most accurate way to set the frequency. For best performance, use a precision metal or thin film resistor of 0.5% or better tolerance and

50ppm/°C or better temperature coefficient. For lower accuracy applications an inexpensive 1% thick film resistor may be used.

Limit the capacitance on the SET pin to less than 10pF to minimize jitter and ensure stability. Capacitance less than 100pF maintains the stability of the feedback circuit regulating the V_{SET} voltage.



RST or \overline{RST} (Pin 4/Pin 1): Output Reset. The reset input is used to stop the output oscillator and to clear internal dividers. When reset is released the oscillator starts with a full half period time interval. The output logic state when reset is determined by the programmed DIVCODE. The LTC6995-1 has an active high RST input. The LTC6995-2 has an active low \overline{RST} input.

LTC6995-1/LTC6995-2

PIN FUNCTIONS (DCB/S6)

GND (Pin 5/Pin 2): Ground. Tie to a low inductance ground plane for best performance.

OUT (Pin 6/Pin 6): Oscillator Output. The OUT pin swings from GND to V^+ with an output resistance of approximately

30Ω . When driving an LED or other low impedance load a series output resistor should be used to limit source/sink current to 20mA.

BLOCK DIAGRAM (S6 package pin numbers shown)



OPERATION

The LTC6995 is built around a master oscillator with a 1MHz maximum frequency. The oscillator is controlled by the SET pin current (I_{SET}) and voltage (V_{SET}), with a $1\text{MHz} \cdot 50\text{k}\Omega$ conversion factor that is accurate to $\pm 0.8\%$ under typical conditions.

$$f_{MASTER} = \frac{1}{t_{MASTER}} = 1\text{MHz} \cdot 50\text{k}\Omega \cdot \frac{I_{SET}}{V_{SET}}$$

A feedback loop maintains V_{SET} at $1\text{V} \pm 30\text{mV}$, leaving I_{SET} as the primary means of controlling the output frequency. The simplest way to generate I_{SET} is to connect a resistor (R_{SET}) between SET and GND, such that $I_{SET} = V_{SET}/R_{SET}$. The master oscillator equation reduces to:

$$f_{MASTER} = \frac{1}{t_{MASTER}} = \frac{1\text{MHz} \cdot 50\text{k}\Omega}{R_{SET}}$$

From this equation, it is clear that V_{SET} drift will not affect the output frequency when using a single program resistor (R_{SET}). Error sources are limited to R_{SET} tolerance and the inherent frequency accuracy Δf_{OUT} of the LTC6995.

R_{SET} may range from 50k to 800k (equivalent to I_{SET} between $1.25\mu\text{A}$ and $20\mu\text{A}$).

Before reaching the OUT pin, the oscillator frequency passes through a fixed $\div 1024$ divider. The LTC6995 also includes a programmable frequency divider which can further divide the frequency by 1, 8, 64, 512, 4096, 2^{15} , 2^{18} or 2^{21} . The divider ratio N_{DIV} is set by a resistor divider attached to the DIV pin.

$$f_{OUT} = \frac{1\text{MHz} \cdot 50\text{k}\Omega}{1024 \cdot N_{DIV}} \cdot \frac{I_{SET}}{V_{SET}}, \text{ or}$$

$$t_{OUT} = \frac{1}{f_{OUT}} = \frac{N_{DIV}}{50\text{k}\Omega} \cdot \frac{V_{SET}}{I_{SET}} \cdot 1.024\text{ms}$$

with R_{SET} in place of V_{SET}/I_{SET} the equation reduces to:

$$t_{OUT} = \frac{N_{DIV} \cdot R_{SET}}{50\text{k}\Omega} \cdot 1.024\text{ms}$$

DIVCODE

The DIV pin connects to an internal, V^+ referenced 4-bit A/D converter that determines the DIVCODE value. DIVCODE programs two settings on the LTC6995:

1. DIVCODE determines the output frequency divider setting, N_{DIV} .
2. DIVCODE determines the polarity of the RST and OUT pins, via the POL bit.

V_{DIV} may be generated by a resistor divider between V^+ and GND as shown in Figure 1.



Figure 1. Simple Technique for Setting DIVCODE

Table 1 offers recommended 1% resistor values that accurately produce the correct voltage division as well as the corresponding N_{DIV} and POL values for the recommended resistor pairs. Other values may be used as long as:

1. The V_{DIV}/V^+ ratio is accurate to $\pm 1.5\%$ (including resistor tolerances and temperature effects)
2. The driving impedance ($R1 \parallel R2$) does not exceed $500\text{k}\Omega$.

If the voltage is generated by other means (i.e., the output of a DAC) it must track the V^+ supply voltage. The last column in Table 1 shows the ideal ratio of V_{DIV} to the supply voltage, which can also be calculated as:

$$\frac{V_{DIV}}{V^+} = \frac{\text{DIVCODE} + 0.5}{16} \pm 1.5\%$$

For example, if the supply is 3.3V and the desired DIVCODE is 4, $V_{DIV} = 0.281 \cdot 3.3\text{V} = 928\text{mV} \pm 50\text{mV}$.

Figure 2 illustrates the information in Table 1, showing that N_{DIV} is symmetric around the DIVCODE midpoint.

OPERATION

Table 1. DIVCODE Programming

DIVCODE	POL	N _{DIV}	RECOMMENDED t _{OUT}	R1 (kΩ)	R2 (kΩ)	V _{DIV} /V ⁺
0	0	1	1.024ms to 16.384ms	Open	Short	≤0.03125 ±0.015
1	0	8	8.192ms to 131ms	976	102	0.09375 ±0.015
2	0	64	65.5ms to 1.05sec	976	182	0.15625 ±0.015
3	0	512	524ms to 8.39sec	1000	280	0.21875 ±0.015
4	0	4,096	4.19sec to 67.1sec	1000	392	0.28125 ±0.015
5	0	32,768	33.6sec to 537sec	1000	523	0.34375 ±0.015
6	0	262,144	268sec to 4,295sec	1000	681	0.40625 ±0.015
7	0	2,097,152	2,147sec to 34,360sec	1000	887	0.46875 ±0.015
8	1	2,097,152	2,147sec to 34,360sec	887	1000	0.53125 ±0.015
9	1	262,144	268sec to 4,295sec	681	1000	0.59375 ±0.015
10	1	32,768	33.6sec to 537sec	523	1000	0.65625 ±0.015
11	1	4,096	4.19sec to 67.1sec	392	1000	0.71875 ±0.015
12	1	512	524ms to 8.39sec	280	1000	0.78125 ±0.015
13	1	64	65.5ms to 1.05sec	182	976	0.84375 ±0.015
14	1	8	8.192ms to 131ms	102	976	0.90625 ±0.015
15	1	1	1.024ms to 16.384ms	Short	Open	≥0.96875 ±0.015



Figure 2. Frequency Range and POL Bit vs DIVCODE

OPERATION

Reset and Polarity Bit Functions

The Reset input, RST for the LTC6995-1 and $\overline{\text{RST}}$ for the LTC6995-2, forces the output to a fixed state and resets the internal clock dividers. The output state when reset is determined by the polarity bit as selected by through the DIVCODE setting.

		OUTPUT (OSCILLATOR START STATE)	
RST/ $\overline{\text{RST}}$	POLARITY	LTC6995-1	LTC6995-2
0	0	Oscillating (Low)	0 (Reset)
1	0	0 (Reset)	Oscillating (Low)
0	1	Oscillating (High)	1 (Reset)
1	1	1 (Reset)	Oscillating (High)

With the POL bit programmed to be 0, the output will be forced low when reset. When reset is released by changing state, the oscillator starts. The next rising edge at the output follows a precise half cycle delay.

With the POL bit programmed to be 1, the output will be forced high when reset. When reset is released by changing state, the oscillator starts. The next falling edge at the output follows a precise half cycle delay.



Figure 3. Reset Timing Diagram (POL Bit = 0)



Figure 4. Reset Timing Diagram (POL Bit = 1)

OPERATION

Changing DIVCODE After Start-Up

Following start-up, the A/D converter will continue monitoring V_{DIV} for changes. The LTC6995 will respond to DIVCODE changes in less than one cycle.

$$t_{DIVCODE} < 500 \cdot t_{MASTER} < t_{OUT}$$

The output may have an inaccurate pulse width during the frequency transition. But the transition will be glitch-free and no high or low pulse can be shorter than the master clock period. A digital filter is used to guarantee the DIVCODE has settled to a new value before making changes to the output.

Start-Up Time

When power is first applied, the power-on reset (POR) circuit will initiate the start-up time, t_{START} . A supply voltage of typically 1.4V (1.2V to 1.5V over temperature) initiates the start-up sequence. The OUT pin is held low during this time. The typical value for t_{START} ranges from 0.5ms to 8ms depending on the master oscillator frequency (independent of N_{DIV}):

$$t_{START(TYP)} = 500 \cdot t_{MASTER}$$

During start-up, the DIV pin A/D converter must determine the correct DIVCODE before the output is enabled. The start-up time may increase if the supply or DIV pin

voltages are not stable. For this reason, it is recommended to minimize the capacitance on the DIV pin so it will properly track V^+ . Less than 100pF will not affect performance.

Start-Up Behavior

When first powered up, the output is held low. If the polarity is set for non-inversion ($POL = 0$) and the output is enabled at the end of the start-up time, OUT will begin oscillating. If the output is being reset ($RST = 1$ for LTC6995-1 and $\overline{RST} = 0$ for LTC6995-2) at the end of the start-up time, it will remain low due to the POL bit = 0. When reset is released the oscillator starts and the output remains low for precisely one half cycle of the programmed period.

In inverted operation ($POL = 1$), the start-up sequence is similar. However, the LTC6995 does not know the correct DIVCODE setting when first powered up, so the output defaults low. At the end of t_{START} , the value of DIVCODE is recognized and OUT goes high (inactive) because $POL = 1$. If the output is being reset ($RST = 1$ for LTC6995-1 and $\overline{RST} = 0$ for LTC6995-2) at the end of the start-up time, it will remain high due to the POL bit = 1. When reset is released the oscillator starts and the output remains high for precisely one half cycle of the programmed period.

Figures 7 to 10 detail the possible start-up sequences.

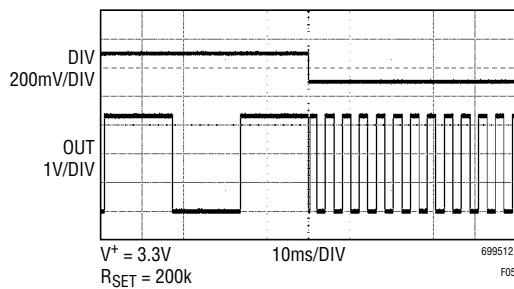

Figure 5. DIVCODE Change from 1 to 0



Figure 6. Typical Start-Up LTC6995-1 with RST = 0V

OPERATION



Figure 7. Start-Up Timing Diagram (Reset = 0, POL Bit = 0)



Figure 8. Start-Up Timing Diagram (Reset = 1, POL Bit = 0)



Figure 9. Start-Up Timing Diagram (Reset = 0, POL Bit = 1)



Figure 10. Start-Up Timing Diagram (Reset = 1, POL Bit = 1)

APPLICATIONS INFORMATION

Basic Operation

The simplest and most accurate method to program the LTC6995 is to use a single resistor, R_{SET} , between the SET and GND pins. The design procedure is a 3-step process. First select the POL bit setting and N_{DIV} value, then calculate the value for the R_{SET} resistor.

Step 1: Select the LTC6995 Version and POL Bit Setting

Determine if the application requires an active-high, LTC6995-1 or active-low, LTC6995-2 reset function. Otherwise the two versions share identical functionality.

The OUT pin polarity depends on the setting of the POL bit. To force $OUT = 0$ during reset, choose POL bit = 0. To force $OUT = 1$ during reset, choose POL bit = 1.

Step 2: Select the N_{DIV} Frequency Divider Value

As explained earlier, the voltage on the DIV pin sets the DIVCODE which determines both the POL bit and the N_{DIV} value. For a given output clock period, N_{DIV} should be selected to be within the following range.

$$\frac{t_{OUT}}{16.384ms} \leq N_{DIV} \leq \frac{t_{OUT}}{1.024ms} \quad (1)$$

To minimize supply current, choose the lowest N_{DIV} value (generally recommended). Alternatively, use Table 1 as a guide to select the best N_{DIV} value for the given application.

With POL already chosen, this completes the selection of DIVCODE. Use Table 1 to select the proper resistor divider or V_{DIV}/V^+ ratio to apply to the DIV pin.

Step 3: Calculate and Select R_{SET}

The final step is to calculate the correct value for R_{SET} using the following equation.

$$R_{SET} = \frac{50k}{1.024ms} \cdot \frac{t_{OUT}}{N_{DIV}} \cdot 1 \quad (2)$$

Select the standard resistor value closest to the calculated value.

Example: Design a 1Hz oscillator with minimum power consumption, an active-high reset input, and the OUT pin low during reset.

Step 1: Select the LTC6995 Version and POL Bit Setting

For active-high reset select the LTC6995-1. For OUT low during reset choose POL bit = 0.

Step 2: Select the N_{DIV} Frequency Divider Value

Choose an N_{DIV} value that meets the requirements of Equation (1), using $t_{OUT} = 1000ms$:

$$61.04 \leq N_{DIV} \leq 976.6$$

Potential settings for N_{DIV} include 64 and 512. $N_{DIV} = 64$ is the best choice, as it minimizes supply current by using a large R_{SET} resistor. POL = 0 and $N_{DIV} = 64$ requires DIVCODE = 2. Using Table 1, choose $R1 = 976k$ and $R2 = 182k$ values to program DIVCODE = 2.

Step 3: Select R_{SET}

Calculate the correct value for R_{SET} using Equation (2).

$$R_{SET} = \frac{50k}{1.024ms} \cdot \frac{1000ms}{64} = 763k$$

Since 763k is not available as a standard 1% resistor, substitute 768k if a -0.7% frequency shift is acceptable. Otherwise, select a parallel or series pair of resistors such as $576k + 187k$ to attain a more precise resistance.

The completed design is shown in Figure 11.



Figure 11. 1Hz Oscillator

APPLICATIONS INFORMATION

Power-On Reset (POR) Function

When power is applied to the LTC6995 the output is held low for t_{START} , then takes on the value of the POL bit as the clock cycle begins. If POL = 0 (DIVCODE < 8) the output will remain low for a programmable interval of $t_{START} + 1/2 t_{OUT}$, assuming the RST pin is inactive. This makes the LTC6995 useful as a programmable long-time power-on reset (POR), with the low output used to hold a system in reset for a fixed period after power is applied. Timing begins when the V^+ supply exceeds approximately 1.4V.

To prevent additional output transitions after the initial POR time, the oscillator can be disabled by removing the SET pin current. This prevents the internal master oscillator output from clocking the frequency dividers or output, while keeping it biased so it can resume operation quickly. The easiest way to implement this feature is to connect R_{SET} between the SET and OUT pins.

Figure 12 shows the basic power-on reset function. When the half cycle times out, the output goes high, eliminates the SET pin current, and stops additional OUT pin transitions. The output remains high until the device is reset by driving the RST input or power is cycled off then back on.

The POR interval is only one half of an oscillator period so component selection is slightly different. Table 2 provides the component values required for one half cycle time intervals. Timing starts after a short startup delay time following the application of the V^+ supply.



$\overline{RST} = V^+$ FOR LTC6995-2

$t_{POR} = 1$ SECOND FOR VALUES SHOWN
 POL = 0
 DIVCODE = 3
 NDIV = 512



Figure 12. Active Low Power-On Reset (1 Second Interval Example)

Table 2. Power-On Reset (POR). One Shot, One Half Cycle Delay Programming

Output Low During Time Interval, POL = 0				
DIVCODE	t_{DELAY} TIME INTERVAL (1/2 t_{OUT})	R1 (k Ω)	R2 (k Ω)	$\sim R_{SET}$ (k Ω)
0	512 μ s to 8.2ms	Open	Short	$t_{DELAY(MS)} \cdot 97.6$
1	4.1ms to 65.5ms	976	102	$t_{DELAY(MS)} \cdot 12.2$
2	32.8ms to 524.3ms	976	182	$t_{DELAY(MS)} \cdot 1.5$
3	262.1ms to 4.2sec	1000	280	$t_{DELAY(SEC)} \cdot 190.7$
4	2.1sec to 33.6sec	1000	392	$t_{DELAY(SEC)} \cdot 23.8$
5	16.8sec to 4.5min	1000	523	$t_{DELAY(MIN)} \cdot 178.6$
6	2.2min to 35.8min	1000	681	$t_{DELAY(MIN)} \cdot 22.7$
7	17.9min to 4.8hrs	1000	887	$t_{DELAY(HR)} \cdot 167.6$

Note: Power-On Reset Time = $t_{DELAY} + t_{START}$

APPLICATIONS INFORMATION

For shorter power-on reset times (1 ms to 73ms) the timer startup delay becomes a significant part of the total POR time. To take this delay into account the value for R_{SET} can be modified from the values shown in Table 2. For a POR time in the range from 1ms to 16ms (DIVCODE = 0), R_{SET} should be $t_{POR}(ms) \cdot 49.5$. For a POR time in the range from 4.5ms to 73ms (DIVCODE = 1), R_{SET} is $t_{POR}(ms) \cdot 10.9$. For longer POR times (DIVCODE 2 through 7) the startup time is insignificant. After power on, the delay following a reset condition will be in the same range as shown for t_{DELAY} in Table 2 for these two DIVCODE selections.

For short POR times, a more precise estimation of the startup time can be found from the following:

$$t_{START}(\mu S) = (256 + 16 \cdot (12 - DIVCODE)) \frac{R_{SET}(k\Omega)}{50} + 80$$

Supply bounce resets the internal timer so the POR circuit automatically debounces supply noise. POR timing starts from the time that the V^+ supply has reached approximately 1.4 volts.

Long Timer One Shots and Delay Generators

The POR circuit of Figure 12 is also useful when the reset inputs are driven. This creates edge triggered timing events that are active low and can either be re-triggered or can stop after one programmed interval. The programmed time interval can range from only 500µs to over 4 hours with just resistor value changes.

The circuits in Figure 13 show how a POR or active low interval can be re-started to provide a full system reset time.

The Figure 14 circuit requires an indication from the system being reset that it is ready before timing out. The LTC6995-2 can accommodate an active high OK signal.

By forcing a reset condition at power on the LTC6995 can be used to create a long time delayed rising edge triggered by either a falling edge signal (LTC6995-1) or a rising edge signal (LTC6995-2) as show in Figure 15.



Figure 13. System Resets On Command with Full POR Time Interval. Reset Pulse Is Debounced Automatically

699512 F13

699512fa

APPLICATIONS INFORMATION



699512 F14

Figure 14. Extended POR. Timer Reset During Initial POR Interval. Full POR Interval Provided Once System Signals the OK



FALLING EDGE TRIGGERED
POL = 0

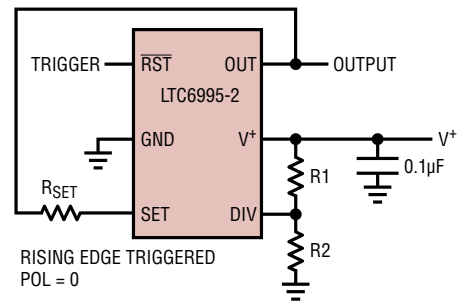

RISING EDGE TRIGGERED
POL = 0

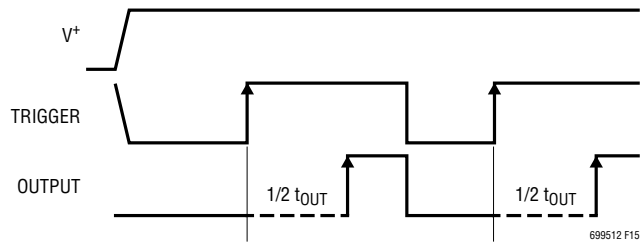

699512 F15

Figure 15. Long Time Delayed Rising Edge. Delay Time Can Range from 500µs to 4.8 Hours

APPLICATIONS INFORMATION

Watchdog Timers

Using the same circuits as shown in Figure 15 with periodic pulsing of the reset input can create an effective watchdog timer. A watchdog pulse is required from a system within each timing interval. The watchdog timeout interval can be programmed from 500 μ s to 4.8 hours. If a pulse is missed the output goes high to indicate that the system software may be caught in an infinite loop. This high level can be used to initiate software diagnostic or restart procedures. The LTC6995 internal clock stops and the output remains high until the software recovers and

returns to issuing watchdog pulses. Figure 16 shows the timing for this application.

Watchdog timers are used to detect if a system operating software is diverted from the designed program sequence for any reason. It is always a possibility that the software could get stuck in a way that keeps the watchdog pulse in the state that holds the timer in the reset so it can never time out. In this condition the watchdog timer is ineffective and will never force corrective action. To help to prevent this a second one shot can be used to reset the watchdog timer as shown in Figure 17.



Figure 16. Watchdog Timer. Same Circuits as Shown in Figure 15



Figure 17. Extra-Reliable Watchdog Timer. Allows Timeout if System Watchdog Pulse Gets Stuck in the Timer Reset State. Both Timer Devices Can Share the Same DIVCODE Setting

APPLICATIONS INFORMATION

Gated Oscillators

The reset input (RST) clears all internal dividers so that, when released, the output will start clocking with a full programmed period. This edge can be used to gate the output ON and OFF at a known starting point for the clock. Circuits which count clock cycles for further timing purposes will always have an accurate count of full cycles until reset. The output clock is always at 50% duty cycle and the period of each cycle can range from 1ms to 9.5 hours. Depending on the polarity bit selection the output clock can start high or low as shown in Figure 18.

Self-Resetting Circuits

The RST pin has hysteresis to accommodate slow-changing input voltages. Furthermore, the trip points are proportional to the supply voltage (see Note 6 and the RST Threshold Voltage vs Supply Voltage curve in Typical Performance Characteristics). This allows an RC time constant at the RST input to generate a delay that is nearly independent of the supply voltage.

A simple application of this technique allows the LTC6995 output to reset itself, producing a well-controlled pulse once each cycle. Figures 19a and 19b show circuits that produce approximately 1 μ s pulses once a minute. The only difference is the version of LTC6995 used and the POL bit setting, which controls whether the pulse is positive or negative.

Voltage Controlled Frequency

With one additional resistor, the LTC6995 output frequency can be manipulated by an external voltage. As shown in Figure 20, voltage V_{CTRL} sources/sinks a current through R_{VCO} to vary the I_{SET} current, which in turn modulates the output frequency as described in Equation (3).

$$f_{OUT} = \frac{1\text{MHz} \cdot 50\text{k}\Omega}{1024 \cdot N_{DIV} \cdot R_{VCO}} \cdot \left(1 + \frac{R_{VCO}}{R_{SET}} - \frac{V_{CTRL}}{V_{SET}} \right) \quad (3)$$



Figure 18. Gated Oscillators. First One-Half Cycle Time Always Accurate

APPLICATIONS INFORMATION



$$t_{\text{PULSE}} = -R_{\text{PW}} \cdot C_{\text{PW}} \cdot \ln\left(1 - \frac{V_{\text{RST(RISING)}}}{V^+}\right)$$

$$t_{\text{PULSE}} \approx -2.26\text{k}\Omega \cdot 470\text{pF} \cdot \ln(1 - 0.61)$$

$$t_{\text{PULSE}} \approx 1\mu\text{s}$$

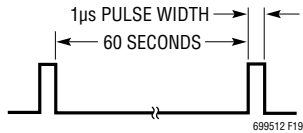

Figure 19a. Self-Resetting Circuit (DIVCODE = 5)



$$t_{\text{PULSE}} = -R_{\text{PW}} \cdot C_{\text{PW}} \cdot \ln\left(\frac{V_{\text{RST(FALLING)}}}{V^+}\right)$$

$$t_{\text{PULSE}} \approx -2.26\text{k}\Omega \cdot 470\text{pF} \cdot \ln(0.43)$$

$$t_{\text{PULSE}} \approx 0.9\mu\text{s}$$

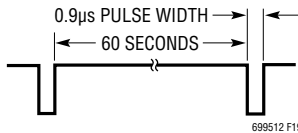

Figure 19b. Self-Resetting Circuit (DIVCODE = 10)



Figure 20. Voltage-Controlled Oscillator

Digital Frequency Control

The control voltage can be generated by a DAC (digital-to-analog converter), resulting in a digitally-controlled frequency. Many DACs allow for the use of an external reference. If such a DAC is used to provide the V_{CTRL} voltage, the V_{SET} dependency can be eliminated by buffering V_{SET} and using it as the DAC's reference voltage, as shown in Figure 21. The DAC's output voltage now tracks any V_{SET} variation and eliminates it as an error source. The SET pin cannot be tied directly to the reference input of the DAC because the current drawn by the DAC's REF input would affect the frequency.

I_{SET} Extremes (Master Oscillator Frequency Extremes)

When operating with I_{SET} outside of the recommended $1.25\mu\text{A}$ to $20\mu\text{A}$ range, the master oscillator operates outside of the 62.5kHz to 1MHz range in which it is most accurate.

The oscillator can still function with reduced accuracy for $I_{\text{SET}} < 1.25\mu\text{A}$. At approximately 500nA , the oscillator output will be frozen in its current state. The output could halt in a high or low state. This avoids introducing short pulses when frequency modulating a very low frequency output.

At the other extreme, it is not recommended to operate the master oscillator beyond 2MHz because the accuracy of the DIV pin ADC will suffer.

APPLICATIONS INFORMATION



Figure 21. Digitally-Controlled Oscillator

Frequency Modulation and Settling Time

The LTC6995 will respond to changes in I_{SET} up to a -3dB bandwidth of $0.4 \cdot f_{OUT}$.

Following a $2\times$ or $0.5\times$ step change in I_{SET} , the output frequency takes less than one cycle to settle to within 1% of the final value.

Power Supply Current

The power supply current varies with frequency, supply voltage and output loading. It can be estimated under any condition using the following equation. This equation ignores C_{LOAD} (valid for $C_{LOAD} < 1\text{nF}$) and assumes the output has 50% duty cycle.

$$I_{S(TYP)} \approx V^+ \cdot f_{MASTER} \cdot 7.8\text{pF} + \frac{V^+}{420\text{k}\Omega} + \frac{V^+}{2 \cdot R_{LOAD}} + 1.8 \cdot I_{SET} + 50\mu\text{A}$$

Supply Bypassing and PCB Layout Guidelines

The LTC6995 is a 2.2% accurate silicon oscillator when used in the appropriate manner. The part is simple to use

and by following a few rules, the expected performance is easily achieved. Adequate supply bypassing and proper PCB layout are important to ensure this.

Figure 22 shows example PCB layouts for both the TSOT-23 and DFN packages using 0603 sized passive components. The layouts assume a two layer board with a ground plane layer beneath and around the LTC6995. These layouts are a guide and need not be followed exactly.

1. Connect the bypass capacitor, C1, directly to the V^+ and GND pins using a low inductance path. The connection from C1 to the V^+ pin is easily done directly on the top layer. For the DFN package, C1's connection to GND is also simply done on the top layer. For the TSOT-23, OUT can be routed through the C1 pads to allow a good C1 GND connection. If the PCB design rules do not allow that, C1's GND connection can be accomplished through multiple vias to the ground plane. Multiple vias for both the GND pin connection to the ground plane and the C1 connection to the ground plane are recommended to minimize the inductance. Capacitor C1 should be a $0.1\mu\text{F}$ ceramic capacitor.

APPLICATIONS INFORMATION



Figure 22. Supply Bypassing and PCB Layout

2. Place all passive components on the top side of the board. This minimizes trace inductance.
3. Place R_{SET} as close as possible to the SET pin and make a direct, short connection. The SET pin is a current summing node and currents injected into this pin directly modulate the operating frequency. Having a short connection minimizes the exposure to signal pickup.
4. Connect R_{SET} directly to the GND pin. Using a long path or vias to the ground plane will not have a significant affect on accuracy, but a direct, short connection is recommended and easy to apply.
5. Use a ground trace to shield the SET pin. This provides another layer of protection from radiated signals.
6. Place R1 and R2 close to the DIV pin. A direct, short connection to the DIV pin minimizes the external signal coupling.

TYPICAL APPLICATIONS

Timed Power Switches, Auto Shutoff After One Hour



5 Second On/Off Timed Relay Driver



TYPICAL APPLICATIONS

1.5ms Radio Control Servo Reference Pulse Generator



Cycling (10 Seconds On/Off) Symmetrical Power Supplies



Isolated AC Load Flasher



TYPICAL APPLICATIONS

Interval (Wiper) Timer



Adjustable Time Lapse Photography Intervalometer



PACKAGE DESCRIPTION

Please refer to <http://www.linear.com/designtools/packaging/> for the most recent package drawings.

S6 Package 6-Lead Plastic TSOT-23 (Reference LTC DWG # 05-08-1636)



NOTE:

1. DIMENSIONS ARE IN MILLIMETERS
2. DRAWING NOT TO SCALE
3. DIMENSIONS ARE INCLUSIVE OF PLATING
4. DIMENSIONS ARE EXCLUSIVE OF MOLD FLASH AND METAL BURR
5. MOLD FLASH SHALL NOT EXCEED 0.254mm
6. JEDEC PACKAGE REFERENCE IS MO-193

DCB Package 6-Lead Plastic DFN (2mm × 3mm) (Reference LTC DWG # 05-08-1715 Rev A)

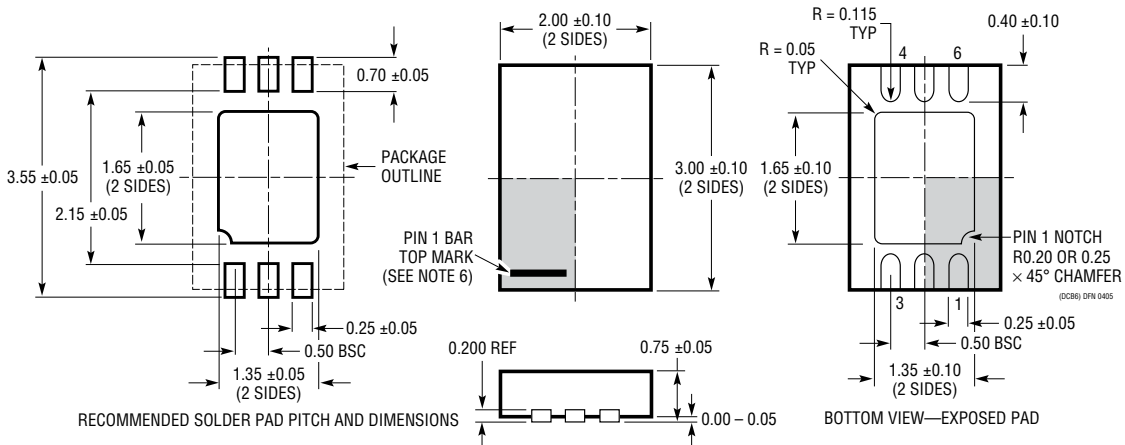

NOTE:

1. DRAWING TO BE MADE A JEDEC PACKAGE OUTLINE MO-229 VARIATION OF (TBD)
2. DRAWING NOT TO SCALE
3. ALL DIMENSIONS ARE IN MILLIMETERS
4. DIMENSIONS OF EXPOSED PAD ON BOTTOM OF PACKAGE DO NOT INCLUDE MOLD FLASH. MOLD FLASH, IF PRESENT, SHALL NOT EXCEED 0.15mm ON ANY SIDE
5. EXPOSED PAD SHALL BE SOLDER PLATED
6. SHADED AREA IS ONLY A REFERENCE FOR PIN 1 LOCATION ON THE TOP AND BOTTOM OF PACKAGE

REVISION HISTORY

REV	DATE	DESCRIPTION	PAGE NUMBER
A	09/13	Grammatical corrections	1, 4, 8, 16
		Correction to Master Oscillator, Block Diagram	8
		Divcode changed from 4 to 5, Figure 19a	20
		Divcode changed from 11 to 10, Figure 19b	20
		LTC6995 block identified as LTC6995-1, Figure 21 and Figure 22	21, 22
		Replace V ⁺ with 5V, Sentry Time schematic	28

TYPICAL APPLICATION

Sentry Timer



699512 TA07

RELATED PARTS

PART NUMBER	DESCRIPTION	COMMENTS
LTC1799	1MHz to 33MHz ThinSOT Silicon Oscillator	Wide Frequency Range
LTC6900	1MHz to 20MHz ThinSOT Silicon Oscillator	Low Power, Wide Frequency Range
LTC6906/LTC6907	10kHz to 1MHz or 40kHz ThinSOT Silicon Oscillators	Micropower, I _{SUPPLY} = 35μA at 400kHz
LTC6930	Fixed Frequency Oscillator, 32.768kHz to 8.192MHz	0.09% Accuracy, 110μs Start-Up Time, 105μA at 32kHz
LTC6990	TimerBlox: Voltage-Controlled Silicon Oscillator	Fixed-Frequency or Voltage-Controlled Operation
LTC6991	TimerBlox: Very Low Frequency Oscillator with Reset	Cycle Time from 1ms to 9.5 Hours, No Capacitors, 2.2% Accurate
LTC6992	TimerBlox: Voltage-Controlled Pulse Width Modulator (PWM)	Simple PWM with Wide Frequency Range
LTC6993	TimerBlox: Monostable Pulse Generator (One Shot)	Resistor Programmable Pulse Width of 1μs to 34sec
LTC6994	TimerBlox: Delay Block/Debouncer	Delays Rising, Falling or Both Edges 1μs to 34sec

Данный компонент на территории Российской Федерации

Вы можете приобрести в компании MosChip.

Для оперативного оформления запроса Вам необходимо перейти по данной ссылке:

<http://moschip.ru/get-element>

Вы можете разместить у нас заказ для любого Вашего проекта, будь то серийное производство или разработка единичного прибора.

В нашем ассортименте представлены ведущие мировые производители активных и пассивных электронных компонентов.

Нашей специализацией является поставка электронной компонентной базы двойного назначения, продукции таких производителей как XILINX, Intel (ex.ALTERA), Vicor, Microchip, Texas Instruments, Analog Devices, Mini-Circuits, Amphenol, Glenair.

Сотрудничество с глобальными дистрибьюторами электронных компонентов, предоставляет возможность заказывать и получать с международных складов практически любой перечень компонентов в оптимальные для Вас сроки.

На всех этапах разработки и производства наши партнеры могут получить квалифицированную поддержку опытных инженеров.

Система менеджмента качества компании отвечает требованиям в соответствии с ГОСТ Р ИСО 9001, ГОСТ РВ 0015-002 и ЭС РД 009

Офис по работе с юридическими лицами:

105318, г.Москва, ул.Щербаковская д.3, офис 1107, 1118, ДЦ «Щербаковский»

Телефон: +7 495 668-12-70 (многоканальный)

Факс: +7 495 668-12-70 (доб.304)

E-mail: info@moschip.ru

Skype отдела продаж:

moschip.ru

moschip.ru_4

moschip.ru_6

moschip.ru_9