

# IB IL 24 PWR IN/PS IB IL 24 PWR IN/PS-PAC

Inline Power Terminal for the  
System Voltages  $U_M$ ,  $U_S$ ,  $U_L$ ,  $U_{ANA}$

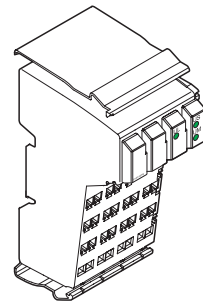

Data Sheet 694500

05/2003

6945A001



Items IB IL 24 PWR IN/PS and IB IL 24 PWR IN/PS-PAC only differ in the scope of supply (see "Ordering Data" on page 13). They have the same functions and technical data.

For reasons of simplification the designation IB IL 24 PWR IN/PS will be used in the following.



This data sheet is only valid in association with the "Configuring and Installing the INTERBUS Inline Product Range" User Manual IB IL SYS PRO UM E or the Systems Manual for your bus system.

## Function

The terminal supplies an Inline station with voltage if there is no bus terminal. This, for example, applies to the ILC 200 UNI. The terminal is supplied with a 24 V DC voltage ( $U_{24V}$ ), from which the communications voltage ( $U_L$ ) and the supply voltage for the analog terminals ( $U_{ANA}$ ) are provided. In addition, the 24 V DC main voltage ( $U_M$ ) and the 24 V DC segment voltage ( $U_S$ ) can be supplied using the terminal.

## Features

- Supplies all 24 V DC voltages required for the low-level signal of an Inline station
- Diagnostic indicators (state of the supply voltages)

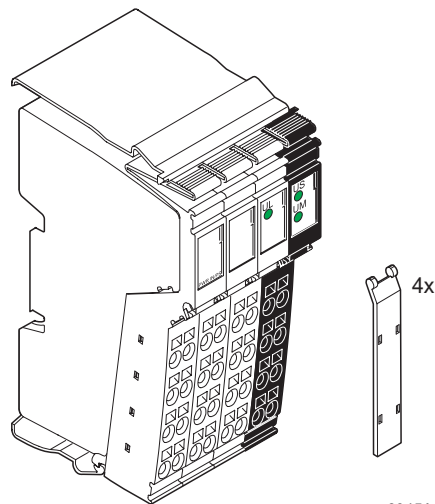

6945A002

Figure 1 IB IL 24 PWR IN/PS terminal with connectors



The terminal interrupts diagonal routing and the bus connection and is thus only to be used at the beginning of an Inline station.

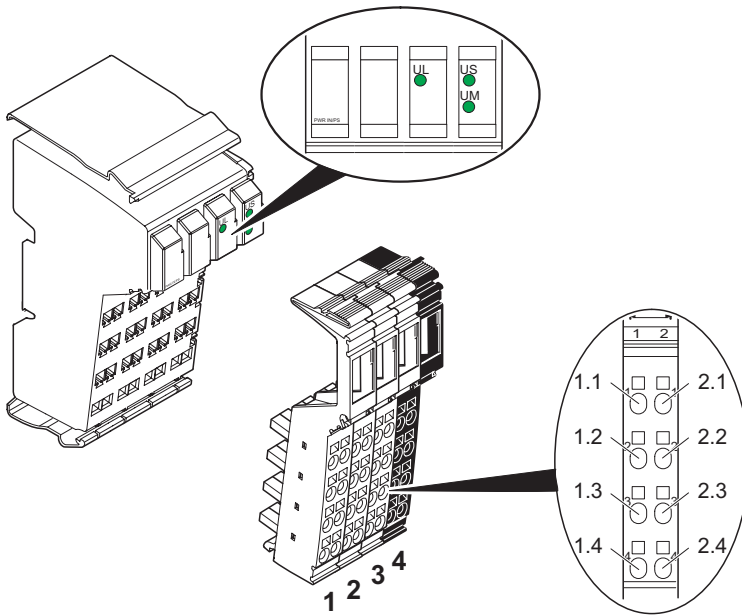

6945A003

Figure 2 IB IL 24 PWR IN/PS with appropriate connectors





Connectors 1 and 2 are not used.

## Local Diagnostic Indicators

Des.	Color	Meaning
UL	Green	7.5 V communications power
US	Green	24 V segment supply
UM	Green	24 V main supply

**Terminal Point Assignment for Connectors 3 and 4**

Terminal Point	Assignment		Remark
<b>Connector 3</b>	<b>24 V Supply for Generating <math>U_L</math> and <math>U_{ANA}</math></b>		
1.1, 2.1			Not used
1.2, 2.2	24 V DC	$U_{24 V}$	24 V supply for generating $U_L$ and $U_{ANA}$
1.3, 2.3	GND	GND	GND of the 24 V supply
1.4, 2.4	FE	Functional earth ground	Grounding of the power terminal and therefore of the Inline station. The contacts are directly connected to the potential jumper and the FE spring on the bottom of the housing.   Functional earth ground is only used to discharge interference.
<b>Connector 4</b>	<b>Power Connector for <math>U_S</math> and <math>U_M</math></b>		
1.1, 2.1	24 V DC	$U_S$	24 V segment supply The supplied voltage is directly led to the potential jumper.
1.2, 2.2	24 V DC	$U_M$	24 V main supply The supplied voltage is directly led to the potential jumper.
1.3, 2.3	GND	Reference potential	The reference potential is directly led to the potential jumper and is, at the same time, ground reference for the main and segment supply.
1.4, 2.4	FE	Functional earth ground	Grounding of the power terminal and therefore of the Inline station. The contacts are directly connected to the potential jumper and the FE spring on the bottom of the housing.   Functional earth ground is only used to discharge interference.



**Observe the current carrying capacity**

The maximum total current of the potential jumpers  $U_M$  and  $U_S$  is 8 A.



**Ground the power terminal**

Connect the power terminal to functional earth ground (FE) via one of the FE connections of connector 3 or connector 4. For this, connect the corresponding contact with a grounding terminal (see also Figure 4 on page 6).

### 24 V Segment Supply/24 V Main Supply

The segment supply and main supply must have the same reference potential. Therefore, an electrically isolated voltage area on the I/O side cannot be created.

The main supply and the segment supply are protected against polarity reversal and transient surge voltage.



#### **Ensure short circuit protection!**

The main supply and the segment supply do not have short-circuit protection.

The user must provide short-circuit protection. The rating of the preconnected fuse must be such that the maximum permissible load current is not exceeded.

### 24 V Segment Supply

You can provide the segment supply at the IB IL 24 PWR IN/PS terminal or one of the supply terminals.

There are several ways of providing the segment voltage at the IB IL 24 PWR IN/PS terminal (connector 4):

1. You can provide the segment supply separately at terminal points 1.1 (or 2.1) and 1.3 (or 2.3) (GND) of the power connector (Figure 4 on page 6).
2. You can jumper connections 1.1 (or 2.1) and 1.2 (or 2.2) to tap the supply for the segment circuit from the main circuit.
3. You can insert a switch between terminal points 1.1 (or 2.1) and 1.2 (or 2.2) to create a switched segment circuit (e.g., an emergency stop circuit).

### 24 V Supply for Generating $U_L$ and $U_{ANA}$

The 24 V supply is protected against polarity reversal and surge voltage. These protective elements are only used to protect the power supply unit.



#### **Ensure short circuit protection!**

The 24 V supply does not have short-circuit protection.

The user must provide short-circuit protection. The rating of the preconnected fuse must be such that the maximum permissible load current is not exceeded.

## Internal Circuit Diagram

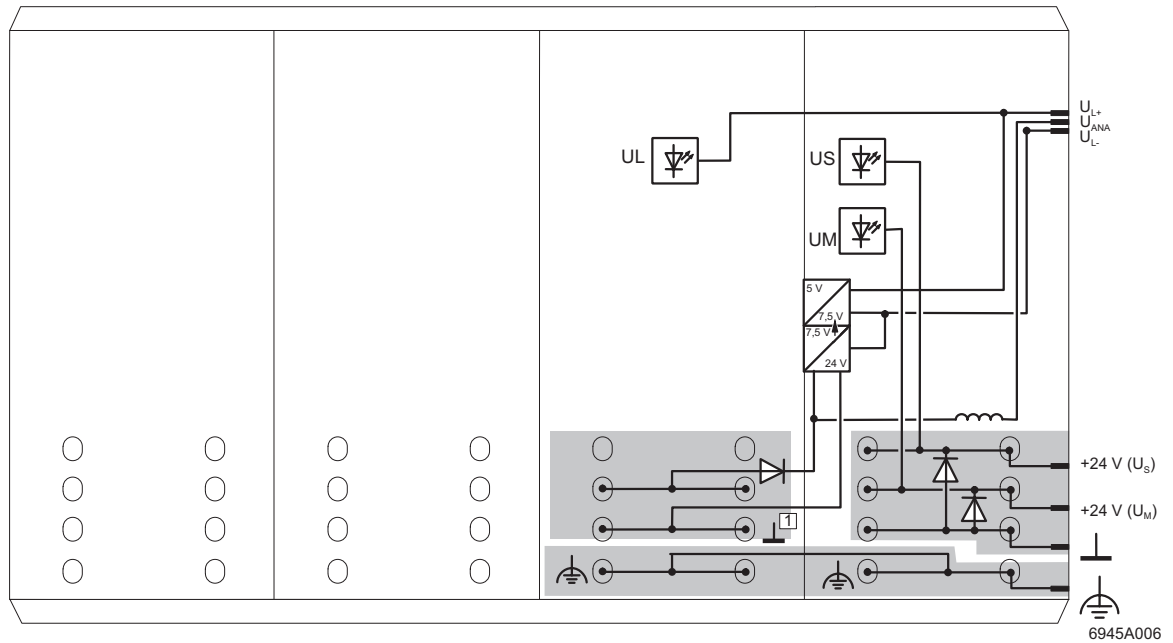



Figure 3 Internal wiring of the terminal points

 LED with function identification

 Electrically isolated area

 Converter

 Diode

 Reference potential GND  
(24 V supply)



Other symbols used are explained  
in the IB IL SYS PRO UM E User  
Manual.

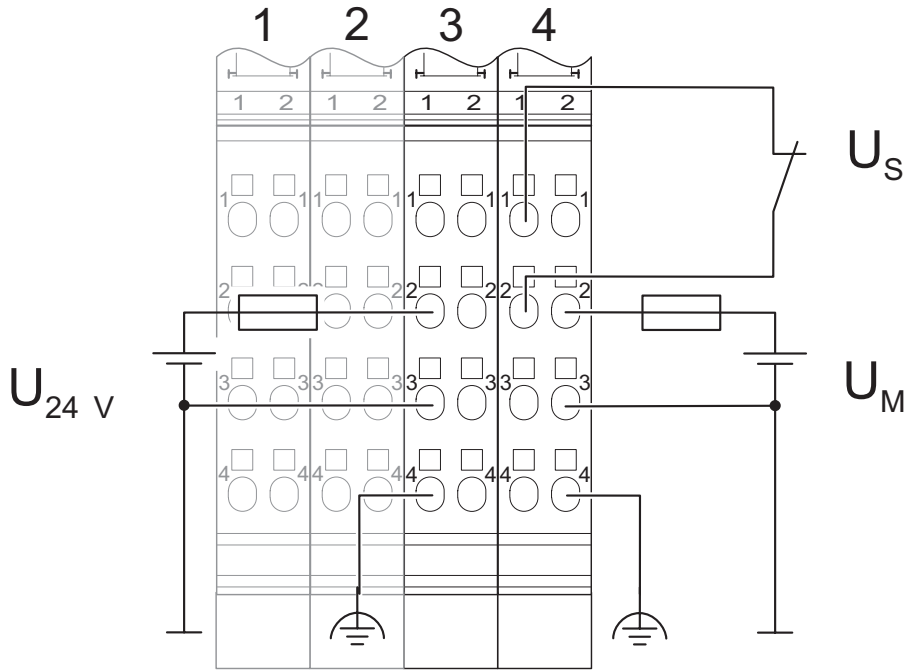

## Connection Example



6945A005

Figure 4 Typical connection of the cables to the power terminal

## Technical Data

General Data	
Order designation	Order no. IB IL 24 PWR IN/PS 28 19 46 4
Order designation	Order no. IB IL 24 PWR IN/PS-PAC 28 63 13 5
Housing dimensions (width x height x depth)	48.8 mm x 120 mm x 71.5 mm (1.921 in. x 4.724 in. x 2.815 in.)
Weight	132 g (without connectors)
Permissible temperature (operation)	-25°C to +55°C (-13°F to +131°F)
Permissible temperature (storage/transport)	-25°C to +85°C (-13°F to +185°F)
Permissible humidity (operation)	75% on average, 85% occasionally
	In the range from -25°C to +55°C (-13°F to +131°F) appropriate measures against increased humidity (> 85%) must be taken.
Permissible humidity (storage/transport)	75% on average, 85% occasionally
	For a short period, slight condensation may appear on the housing if, for example, the terminal is brought into a closed room from a vehicle.
Permissible air pressure (operation)	80 kPa to 106 kPa (up to 2000 m [6562 ft.] above sea level)
Permissible air pressure (storage/transport)	70 kPa to 106 kPa (up to 3000 m [9843 ft.] above sea level)
Degree of protection	IP 20 according to IEC 60529
Class of protection	Class 3 according to VDE 0106, IEC 60536
Interface	
Local bus	Through data routing

24 V Main Supply/24 V Segment Supply	
Connection	Through power connector; Terminal point assignment see page 3
Connection method	Spring-cage terminals
Recommended cable lengths	30 m (98.43 ft.), maximum; routing cables through outdoor areas is not permissible
Voltage continuation	Through potential routing
Special demands on the voltage supply	When supply voltages $U_M/U_S$ are supplied separately from supply voltage $U_{24V}$ , they are electrically isolated from one another. This is only possible when using two separate power supply units.
Response when voltage dips and interrupts occur	Voltages (main and segment supply) that are transferred from the power terminal to the potential jumpers follow the supply voltages without delay.
Nominal value	24 V DC
Tolerance	-15%/+20% (according to EN 61131-2)
Ripple	$\pm 5\%$
Permissible range	19.2 V to 30 V
Current carrying capacity	8 A, maximum
Safety equipment	
Surge voltage	Yes
Polarity reversal	Yes
	<p><b>Provide an external fuse for the 24 V area</b></p> <p>This 24 V area must be externally protected. The power supply unit must be able to supply four times the nominal current of the external fuse, to ensure that the fuse blows in the event of an error.</p>



<b>24 V Supply for Generating <math>U_L</math> and <math>U_{ANA}</math></b>	
Connection	Through connector; Terminal point assignment see page 3
Connection method	Spring-cage terminals
Recommended cable lengths	30 m (98.43 ft.) maximum; routing cables through outdoor areas is not permissible
Voltage continuation	Through potential routing
Special demands on the voltage supply	When supply voltage $U_{24V}$ is supplied separately from supply voltages $U_M/U_S$ , they are electrically isolated from one another. This is only possible when using two separate power supply units.
Nominal value	24 V DC
Tolerance	-15%/+20% (according to EN 61131-2)
Ripple	$\pm 5\%$
Permissible range	19.2 V to 30 V
Minimum current consumption at nominal voltage	0.012 A DC
Maximum current consumption at nominal voltage	1.25 A DC consisting of: 0.75 A DC for communications power 0.5 A DC for analog voltage supply
Safety equipment	Only for the 24 V supply
Surge voltage	Yes
Polarity reversal	Yes
	<p><b>Provide an external fuse for the 24 V area</b></p> <p>This 24 V area must be externally protected. The power supply unit must be able to supply four times the nominal current of the external fuse, to ensure that the fuse blows in the event of an error.</p>

24 V Module Supply	
<b>Communications Power (Potential Jumper)</b>	
Nominal value	7.5 V DC
Tolerance	± 5%
Ripple	± 1.5%
Maximum output current	2 A DC
Safety equipment	Electronic short-circuit protection
<b>Analog Supply (Potential Jumper)</b>	
Nominal value	24 V DC
Tolerance	- 15% / + 20%
Ripple	± 5%
Maximum output current	0.5 A DC
Safety equipment	Electronic short-circuit protection

Power Dissipation	
<b>Formula to Calculate the Power Dissipation of the Electronics</b>	
$P_{EL} = (1.1 \frac{W}{A} \times \sum_{n=1}^a I_{Ln}) + (0.7 \frac{W}{A} \times \sum_{m=1}^b I_{Lm})$	
Where	
$P_{EL}$	Total power dissipation in the terminal
$I_{Ln}$	Current consumption of the device $n$ from the communications power
$n$	Index of the number of connected devices ( $n = 1$ to $a$ )
$a$	Number of connected devices (supplied with communications voltage)
$\sum_{n=1}^a I_{Ln}$	Total current consumption of the devices from the 7.5 V communications power (2 A, maximum)
$I_{Lm}$	Current consumption of the device $m$ from the analog supply
$m$	Index of the number of connected analog devices ( $m = 1$ to $b$ )
$b$	Number of connected analog devices (supplied with analog voltage)
$\sum_{m=1}^b I_{Lm}$	Total current consumption of the devices from the 24 V analog power (0.5 A, maximum)

**Power Dissipation (Continued)**

Using the maximum currents 2 A (logic current) and 0.5 A (current for analog terminals) in the formula to calculate the power dissipation when the I/O is connected gives the following result:

$$P_{EL} = 2.2 \text{ W} + 0.35 \text{ W} = 2.55 \text{ W}$$

**Error Messages to the Higher-Level Control or Computer System**

None

**Safety Equipment**

Surge voltage (segment supply/main supply/24 V supply)	Input protective diodes (can be destroyed by permanent overload)  Pulse loads up to 1500 W are short circuited by the input protective diode.
Polarity reversal (segment supply/main supply)	Parallel diodes against polarity reversal; in the event of an error the high current through the diodes causes the preconnected fuse to blow.
Polarity reversal (24 V supply)	Serial diode in the lead path of the power supply unit; in the event of an error only a low current flows. In the event of an error the fuse in the external power supply unit does not trip.



If you want to protect the supply  $U_{24V}$ , use a 2 A medium blow fuse.

Electrical Isolation/Isolation of the Voltage Areas	
<b>Common Potentials</b>	
When providing the 24 V supply for generating $U_L$ and $U_{ANA}$ separately from the 24 V main supply/24 V segment supply	<p>Main supply and segment supply have the same potential. From the power terminal onwards, common ground is led through the potential jumper to the devices as reference ground GND.</p> <p>24 V supply for generating <math>U_L</math> and <math>U_{ANA}</math>, 24 V analog supply and 7.5 V communications power have the same potential. From the bus terminal onwards, common ground is led through the potential jumper to the devices as reference ground "logical GND" (<math>U_L</math>).</p>
When providing the 24 V supply for generating $U_L$ and $U_{ANA}$ by jumpering the 24 V main supply/24 V segment supply	<p>Main supply, segment supply, 24 V analog supply, and 7.5 V communications power have the same potential. From the power terminal onwards, common ground is led through the potential jumper to the devices as reference ground "logical GND" (<math>U_L</math>) for the communications power and analog supply and separately as reference ground GND for the supply and segment level.</p>
<b>Separate Potentials</b>	
When providing the 24 V supply for generating $U_L$ and $U_{ANA}$ separately from the 24 V main supply/24 V segment supply	<p>The 24 V supply for generating <math>U_L</math> and <math>U_{ANA}</math> is physically and therefore electrically isolated from the main supply and segment supply.</p>
When providing the 24 V supply for generating $U_L$ and $U_{ANA}$ by jumpering the 24 V main supply/24 V segment supply	<p>None</p>

Electrical Isolation/Isolation of the Voltage Areas	
Test Distance	Test Voltage
7.5 V communications power, 24 V analog supply/ functional earth ground	500 V AC, 50 Hz, 1 min
7.5 V communications power, 24 V analog supply/ 24 V main supply, 24 V segment supply	500 V AC, 50 Hz, 1 min
24 V main supply, 24 V segment supply/ functional earth ground	500 V AC, 50 Hz, 1 min

## Ordering Data

Description	Order Designation	Order No.
Inline power terminal for the system voltages $U_M$ , $U_S$ , $U_L$ , $U_{ANA}$ including connectors and labeling fields	IB IL 24 PWR IN/PS-PAC	28 63 13 5
Inline power terminal for the system voltages $U_M$ , $U_S$ , $U_L$ , $U_{ANA}$	IB IL 24 PWR IN/PS	28 19 46 4
Connector set with all necessary connectors for the terminal	IB IL PWR IN/R-PLSET	28 60 62 0
"Configuring and Installing the INTERBUS Inline Product Range" User Manual	IB IL SYS PRO UM E	27 43 04 8

Phoenix Contact GmbH & Co. KG  
Flachsmarktstr. 8  
32825 Blomberg  
Germany



+ 49 - (0) 52 35 - 3-00



+ 49 - (0) 52 35 - 3-4 12 00



[www.phoenixcontact.com](http://www.phoenixcontact.com)



Worldwide Locations:

[www.phoenixcontact.com/salesnetwork](http://www.phoenixcontact.com/salesnetwork)

## Данный компонент на территории Российской Федерации

### Вы можете приобрести в компании MosChip.

Для оперативного оформления запроса Вам необходимо перейти по данной ссылке:

<http://moschip.ru/get-element>

Вы можете разместить у нас заказ для любого Вашего проекта, будь то серийное производство или разработка единичного прибора.

В нашем ассортименте представлены ведущие мировые производители активных и пассивных электронных компонентов.

Нашей специализацией является поставка электронной компонентной базы двойного назначения, продукции таких производителей как XILINX, Intel (ex.ALTERA), Vicor, Microchip, Texas Instruments, Analog Devices, Mini-Circuits, Amphenol, Glenair.

Сотрудничество с глобальными дистрибьюторами электронных компонентов, предоставляет возможность заказывать и получать с международных складов практически любой перечень компонентов в оптимальные для Вас сроки.

На всех этапах разработки и производства наши партнеры могут получить квалифицированную поддержку опытных инженеров.

Система менеджмента качества компании отвечает требованиям в соответствии с ГОСТ Р ИСО 9001, ГОСТ РВ 0015-002 и ЭС РД 009

### Офис по работе с юридическими лицами:

105318, г.Москва, ул.Щербаковская д.3, офис 1107, 1118, ДЦ «Щербаковский»

Телефон: +7 495 668-12-70 (многоканальный)

Факс: +7 495 668-12-70 (доб.304)

E-mail: [info@moschip.ru](mailto:info@moschip.ru)

Skype отдела продаж:

moschip.ru

moschip.ru\_4

moschip.ru\_6

moschip.ru\_9