

MG06600WB-BN4MM

RoHS

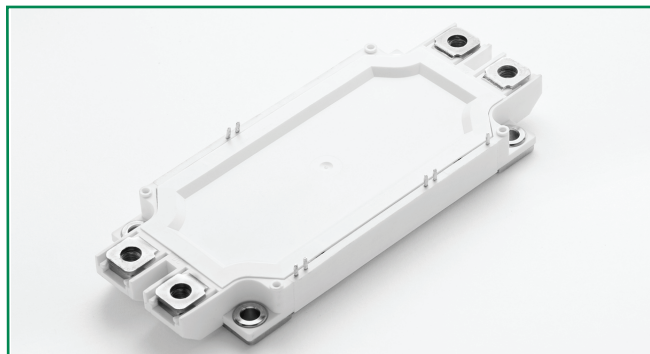

Features

- High short circuit capability, self limiting short circuit current
- $V_{CE(sat)}$ with positive temperature coefficient
- Fast switching and short tail current
- Free wheeling diodes with fast and soft reverse recovery
- Low switching losses

Applications

- High frequency switching application
- Medical applications
- Motion/servo control supplies
- UPS systems

Module Characteristics ($T_J = 25^\circ\text{C}$, unless otherwise specified)

Symbol	Parameters	Test Conditions	Min	Typ	Max	Unit
T_{Jmax}	Max. Junction Temperature				175	$^\circ\text{C}$
T_{Jop}	Operating Temperature		-40		150	$^\circ\text{C}$
T_{stg}	Storage Temperature		-40		125	$^\circ\text{C}$
V_{isol}	Insulation Test Voltage	AC, t=1min		3000		V
CTI	Comparative Tracking Index		250			
Torque	Module-to-Sink	Recommended (M5)	2.5		5	N·m
Torque	Module Electrodes	Recommended (M6)	3		5	N·m
Weight				350		g

Absolute Maximum Ratings ($T_J = 25^\circ\text{C}$, unless otherwise specified)

Symbol	Parameters	Test Conditions	Values	Unit
IGBT				
V_{CES}	Collector - Emitter Voltage	$T_J=25^\circ\text{C}$	600	V
V_{GES}	Gate - Emitter Voltage		± 20	V
I_C	DC Collector Current	$T_C=25^\circ\text{C}$	700	A
		$T_C=50^\circ\text{C}$	600	A
I_{CM}	Repetitive Peak Collector Current	$t_p=1\text{ms}$	1200	A
P_{tot}	Power Dissipation Per IGBT		1500	W
Diode				
V_{RRM}	Repetitive Reverse Voltage	$T_J=25^\circ\text{C}$	600	V
$I_{F(AV)}$	Average Forward Current	$T_C=25^\circ\text{C}$	700	A
		$T_C=50^\circ\text{C}$	600	A
I_{FRM}	Repetitive Peak Forward Current	$t_p=1\text{ms}$	1200	A
I^2t		$T_J=125^\circ\text{C}$, t=10ms, $V_R=0\text{V}$	17000	A^2s

Electrical and Thermal Specifications ($T_J = 25^\circ\text{C}$, unless otherwise specified)

Symbol	Parameters	Test Conditions	Min	Typ	Max	Unit
IGBT						
$V_{GE(th)}$	Gate - Emitter Threshold Voltage	$V_{CE}=V_{GE}, I_C=9.6\text{mA}$	4.9	5.8	6.5	V
$V_{CE(sat)}$	Collector - Emitter	$I_C=600\text{A}, V_{GE}=15\text{V}, T_J=25^\circ\text{C}$		1.45		V
	Saturation Voltage	$I_C=600\text{A}, V_{GE}=15\text{V}, T_J=125^\circ\text{C}$		1.6		V
I_{ICES}	Collector Leakage Current	$V_{CE}=600\text{V}, V_{GE}=0\text{V}, T_J=25^\circ\text{C}$			1	mA
		$V_{CE}=600\text{V}, V_{GE}=0\text{V}, T_J=125^\circ\text{C}$			5	mA
I_{GES}	Gate Leakage Current	$V_{CE}=0\text{V}, V_{GE}=\pm 15\text{V}, T_J=125^\circ\text{C}$	-400		400	nA
R_{Gint}	Integrated Gate Resistor			0.68		Ω
Q_{ge}	Gate Charge	$V_{CE}=300\text{V}, I_C=600\text{A}, V_{GE}=\pm 15\text{V}$		6.5		μC
C_{ies}	Input Capacitance	$V_{CE}=25\text{V}, V_{GE}=0\text{V}, f=1\text{MHz}$		39		nF
C_{res}	Reverse Transfer Capacitance			1.15		nF
$t_{d(on)}$	Turn - on Delay Time	$V_{CC}=300\text{V}$ $I_C=600\text{A}$ $R_G=2.4\Omega$ $V_{GE}=\pm 15\text{V}$ Inductive Load	$T_J=25^\circ\text{C}$		100	ns
			$T_J=125^\circ\text{C}$		110	ns
t_r	Rise Time		$T_J=25^\circ\text{C}$		90	ns
			$T_J=125^\circ\text{C}$		95	ns
$t_{d(off)}$	Turn - off Delay Time		$T_J=25^\circ\text{C}$		670	ns
			$T_J=125^\circ\text{C}$		710	ns
t_f	Fall Time		$T_J=25^\circ\text{C}$		70	ns
			$T_J=125^\circ\text{C}$		75	ns
E_{on}	Turn - on Energy		$T_J=25^\circ\text{C}$		8.9	mJ
			$T_J=125^\circ\text{C}$		9.9	mJ
E_{off}	Turn - off Energy	$T_J=25^\circ\text{C}$		21.5	mJ	
		$T_J=125^\circ\text{C}$		25	mJ	
I_{SC}	Short Circuit Current	$t_{psc}\leq 6\mu\text{s}, V_{GE}=15\text{V}; T_J=125^\circ\text{C}, V_{CC}=360\text{V}$		3000		A
R_{thJC}	Junction-to-Case Thermal Resistance (Per IGBT)				0.10	K/W
Diode						
V_F	Forward Voltage	$I_F=600\text{A}, V_{GE}=0\text{V}, T_J=25^\circ\text{C}$		1.55		V
		$I_F=600\text{A}, V_{GE}=0\text{V}, T_J=125^\circ\text{C}$		1.5		V
t_{RR}	Reverse Recovery Time	$I_F=600\text{A}, V_R=300\text{V}$ $di_F/dt=-6000\text{A}/\mu\text{s}$ $T_J=125^\circ\text{C}$		400		ns
I_{RRM}	Max. Reverse Recovery Current			300		A
E_{rec}	Reverse Recovery Energy			9.3		mJ
R_{thJCD}	Junction-to-Case Thermal Resistance (Per Diode)				0.16	K/W

NTC Characteristics ($T_J = 25^\circ\text{C}$, unless otherwise specified)

Symbol	Parameters	Test Conditions	Min	Typ	Max	Unit
R_{25}	Resistance	$T_c=25^\circ\text{C}$		5		K Ω
$B_{25/50}$				3375		K

Figure 1: Typical Output Characteristics for IGBT Inverter

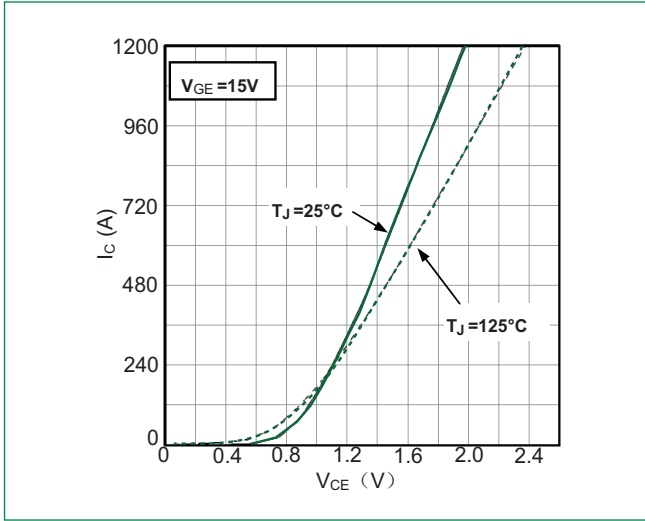

Figure 2: Typical Output Characteristics for IGBT Inverter

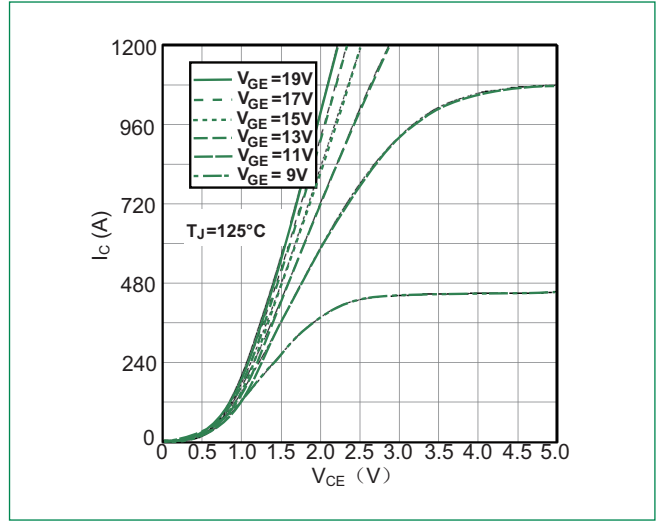

Figure 3: Typical Transfer Characteristics for IGBT Inverter

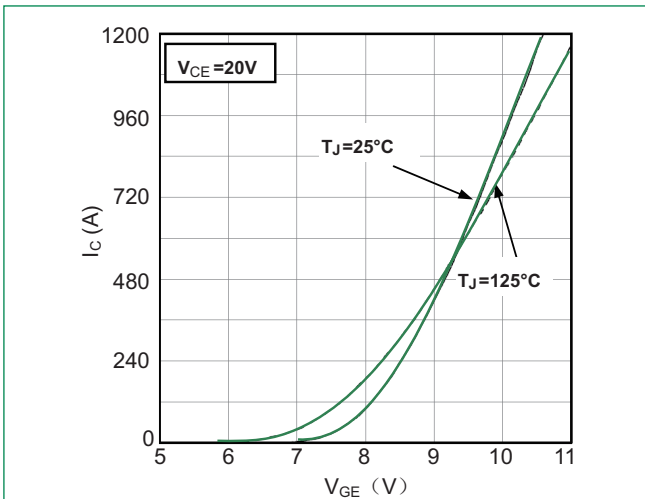

Figure 4: Switching Energy vs. Gate Resistor for IGBT Inverter

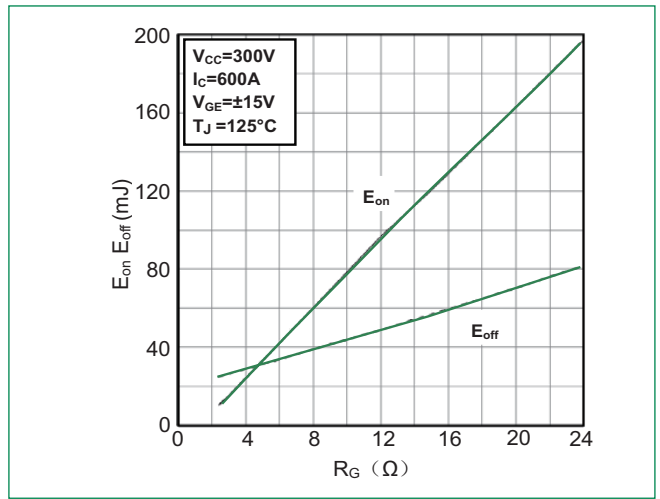

Figure 5: Switching Energy vs. Collector Current for IGBT Inverter

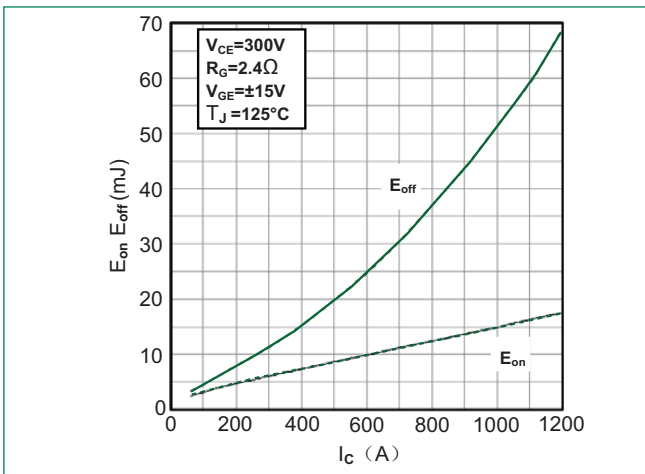

Figure 6: Reverse Biased Safe Operating Area for IGBT Inverter

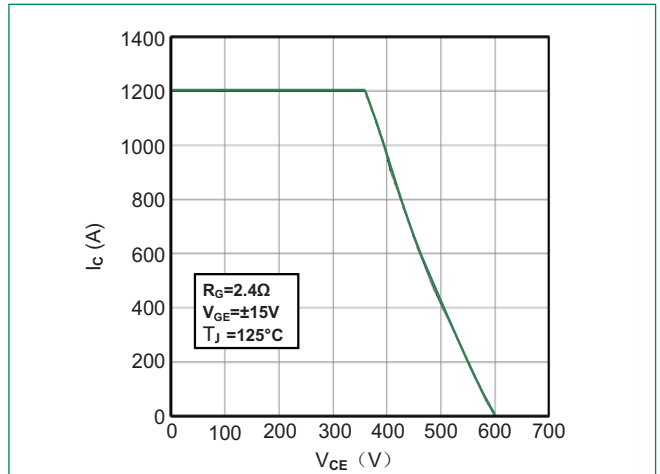

Figure 7: Diode Forward Characteristics for Diode Inverter

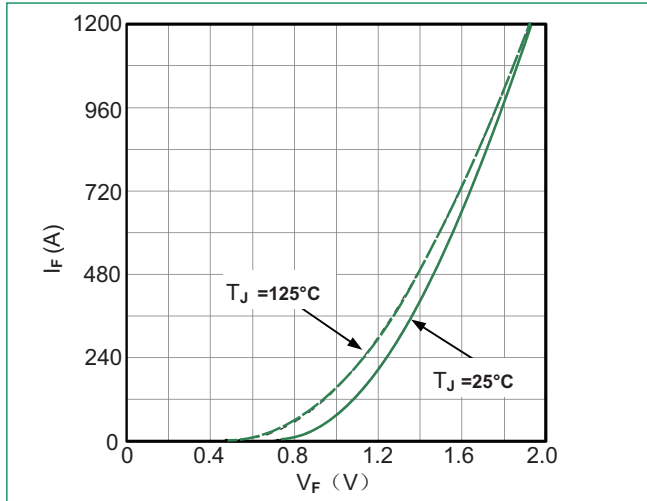

Figure 8: Switching Energy vs. Gate Resistort for Diode Inverter

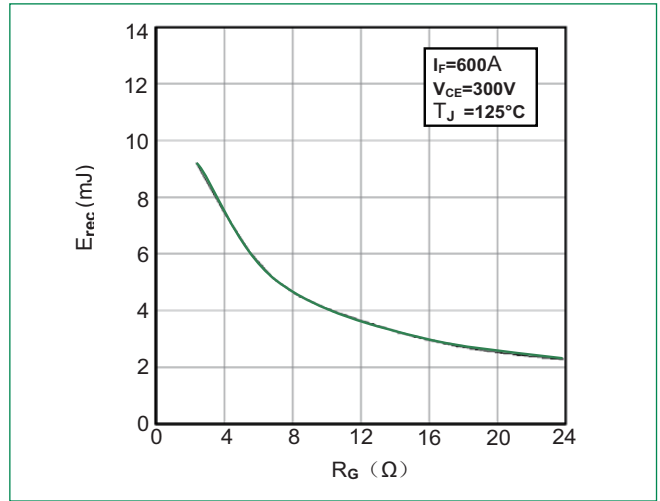

Figure 9: Transient Thermal Impedance of Diode and IGBT Inverter

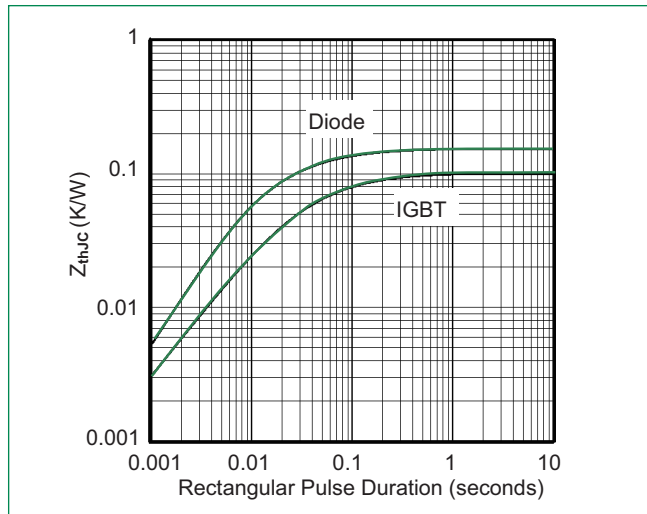
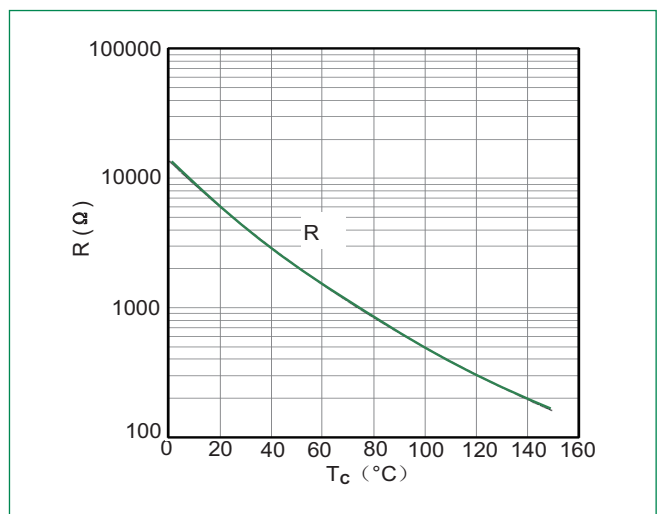
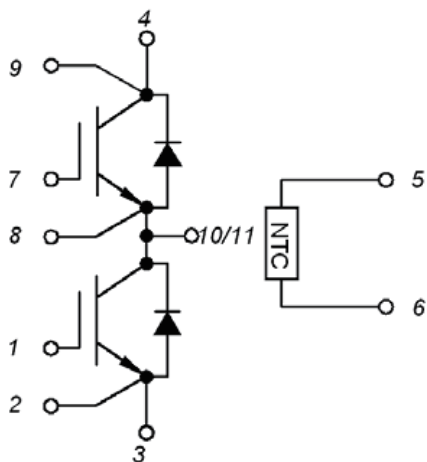

Figure 10: NTC Characteristics



Circuit Diagram



Dimensions-Package WB

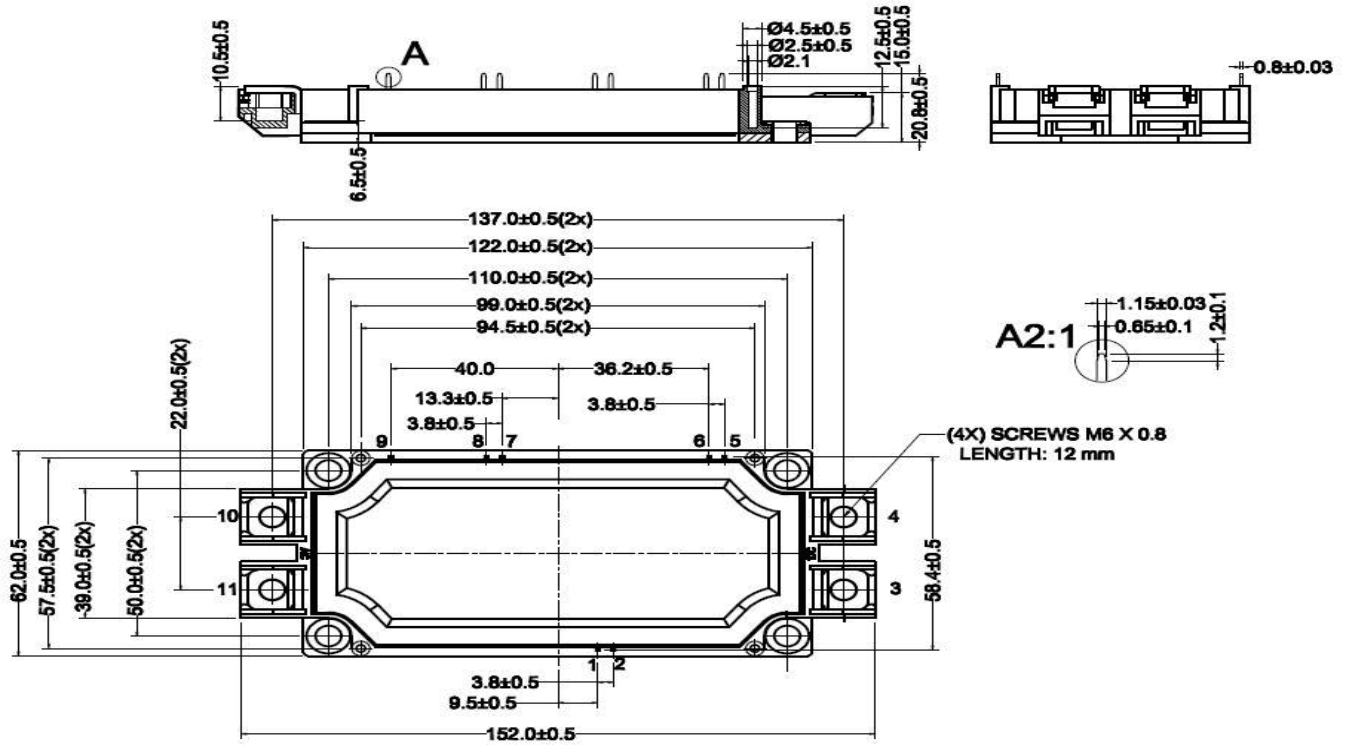

The foot pins are in gold / nickel coating

Packing Options

Part Number	Marking	Weight	Packing Mode	M.O.Q
MG06600WB-BN4MM	MG06600WB-BN4MM	350g	Bulk Pack	60

Part Numbering System

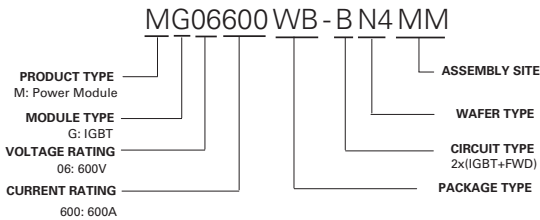

Part Marking System

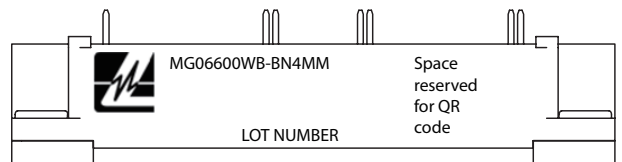

Данный компонент на территории Российской Федерации

Вы можете приобрести в компании MosChip.

Для оперативного оформления запроса Вам необходимо перейти по данной ссылке:

<http://moschip.ru/get-element>

Вы можете разместить у нас заказ для любого Вашего проекта, будь то серийное производство или разработка единичного прибора.

В нашем ассортименте представлены ведущие мировые производители активных и пассивных электронных компонентов.

Нашей специализацией является поставка электронной компонентной базы двойного назначения, продукции таких производителей как XILINX, Intel (ex.ALTERA), Vicor, Microchip, Texas Instruments, Analog Devices, Mini-Circuits, Amphenol, Glenair.

Сотрудничество с глобальными дистрибьюторами электронных компонентов, предоставляет возможность заказывать и получать с международных складов практически любой перечень компонентов в оптимальные для Вас сроки.

На всех этапах разработки и производства наши партнеры могут получить квалифицированную поддержку опытных инженеров.

Система менеджмента качества компании отвечает требованиям в соответствии с ГОСТ Р ИСО 9001, ГОСТ РВ 0015-002 и ЭС РД 009

Офис по работе с юридическими лицами:

105318, г.Москва, ул.Щербаковская д.3, офис 1107, 1118, ДЦ «Щербаковский»

Телефон: +7 495 668-12-70 (многоканальный)

Факс: +7 495 668-12-70 (доб.304)

E-mail: info@moschip.ru

Skype отдела продаж:

moschip.ru

moschip.ru_4

moschip.ru_6

moschip.ru_9