

## VOLTAGE AND CURRENT CONTROL IC

### ■GENERAL DESCRIPTION

The **NJM2346** is a low power operation battery charger IC. It includes a voltage reference and two operational amplifiers for voltage and current control needed for a design of secondary circuit for battery chargers and switching regulators.

Low current consumption design contributes low standby power required for 1A class battery chargers.

### ■PACKAGE OUTLINE

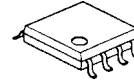

**NJM2346M**



**NJM2346RB1**

### ■FEATURES

- Low Quiescent Current                    250uA typ.
- Precision AMP.                             $V_{io}=0.5mV$  typ.
- Operating Voltage                        2.2V to 13V
- Precision Voltage Reference             $1.24V \pm 1\%$
- PC pin Sink Current                      20mA max.
- Bipolar Technology
- Package Outline                            DMP8, TVSP8

### ■PIN CONFIGURATION

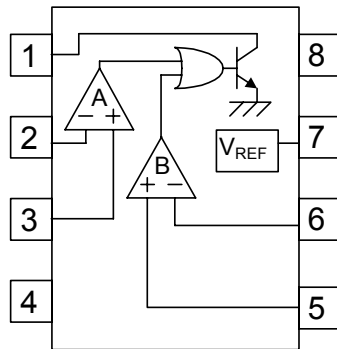

### PIN FUNCTION

1. PC
2. A -INPUT
3. A +INPUT
4. GND
5. B +INPUT
6. B -INPUT
7.  $V_{REF}$
8.  $V^+$

### ■ABSOLUTE MAXIMUM RATINGS ( $T_a=25^\circ C$ )

PARAMETER	SYMBOL	MAXIMUM RATINGS	UNIT
Supply Voltage	$V^+$	14	V
Differential Input Voltage	$V_{ID}$	(Ach) 14 (Bch) 14	V
Common Mode Input Voltage	$V_{IC}$	(Ach) -0.3 ~ 14 (note) (Bch) -0.3 ~ 14 (note)	V
PC Terminal Current	$I_{PC}$	20	mA
Power Dissipation	$P_D$	(DMP 8) 300 (TVSP 8) 320	mW
Operating Temperature Range	$T_{OPR}$	-40 ~ +85	$^\circ C$
Storage Temperature Range	$T_{STG}$	-50 ~ +150	$^\circ C$

(note) When the supply voltage is less than 14V,  
the absolute maximum input voltage is equal to the supply voltage.

# NJM2346

## ■RECOMMENDED OPERATING CONDITIONS (Ta=25°C)

PARAMETER	SYMBOL	MAXIMUM RATINGS	UNIT
Operating Voltage	Vopr	2.2 ~ 13	V

## ■ELECTRICAL CHARACTERISTICS (V<sup>+</sup>=5V, Ta=25°C)

### GENERAL CHARACTERISTICS

PARAMETER	SYMBOL	TEST CONDITION	MIN.	TYP.	MAX.	UNIT
Operating Current	I <sub>CC</sub>	I <sub>PC</sub> =off	–	250	350	μA
Leakage Current	I <sub>PCLEAK</sub>	V <sup>+</sup> =V <sub>PC</sub> =13V	–	–	1	μA
Saturation Voltage	V <sub>PC(SAT)</sub>	I <sub>PC</sub> =20mA	–	0.1	0.3	V
Reference Voltage	V <sub>REF</sub>	I <sub>REF</sub> =0mA	1227	1240	1253	mV
Reference Voltage Load Regulation	$\frac{\Delta V_{REF}}{\Delta I_{REF}}$	I <sub>REF</sub> =0mA ~ 1mA	–	–	10	mV

### [Ach]

PARAMETER	SYMBOL	TEST CONDITION	MIN.	TYP.	MAX.	UNIT
Input Offset Voltage	V <sub>IO</sub>		–	0.5	2	mV
Input Offset Current	I <sub>IO</sub>		–	10	50	nA
Input Bias Current	I <sub>B</sub>		–	40	160	nA
Large Signal Voltage Gain	A <sub>V</sub>		–	80	–	dB
Input Common Mode Voltage Range	V <sub>ICM</sub>		-0.2 ~ 3.0	–	–	V
Common Mode Rejection Ratio	CMR		–	80	–	dB
Supply Voltage Rejection Ratio	SVR		–	80	–	dB
Slew Rate	SR		–	0.5	–	V/μA
Gain Bandwidth Product	GB	f=10kHz	–	1	–	MHz

### [Bch]

PARAMETER	SYMBOL	TEST CONDITION	MIN.	TYP.	MAX.	UNIT
Input Offset Voltage	V <sub>IO</sub>		–	0.5	2	mV
Input Offset Current	I <sub>IO</sub>		–	10	50	nA
Input Bias Current	I <sub>B</sub>		–	20	80	nA
Large Signal Voltage Gain	A <sub>V</sub>		–	80	–	dB
Input Common Mode Voltage Range	V <sub>ICM</sub>		0.5 ~ 4.0	–	–	V
Common Mode Rejection Ratio	CMR		–	80	–	dB
Supply Voltage Rejection Ratio	SVR		–	80	–	dB
Slew Rate	SR		–	0.5	–	V/μA
Gain Bandwidth Product	GB	f=10kHz	–	1	–	MHz

## ■ TYPICAL APPLICATIONS

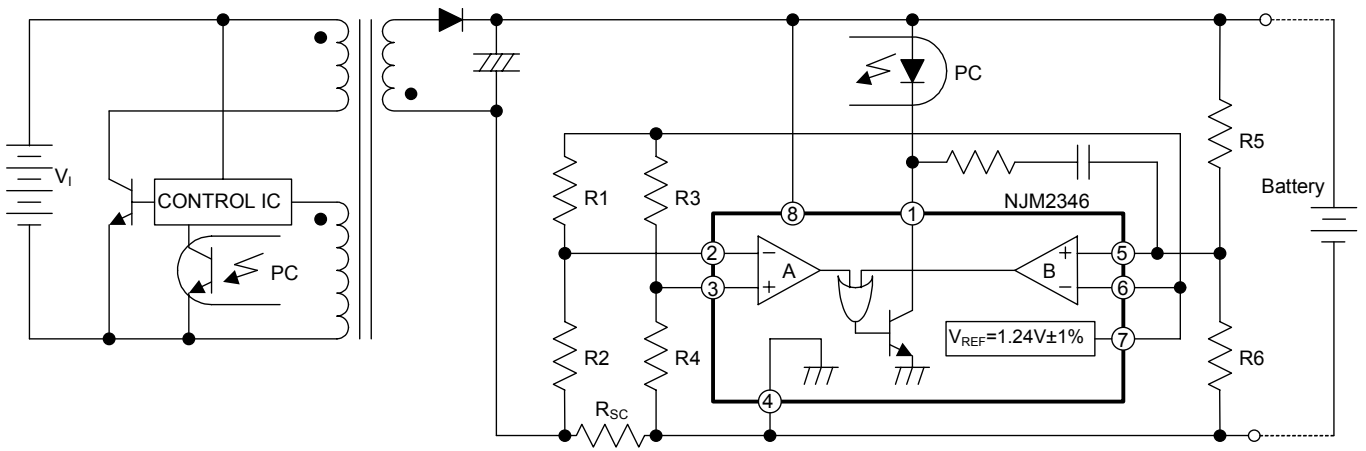

## ■ TYPICAL CHARACTERISTICS

Ach Voltage Gain · Phase vs. Frequency  
( $V^+ = 5V, T_a = 25^\circ C$ )

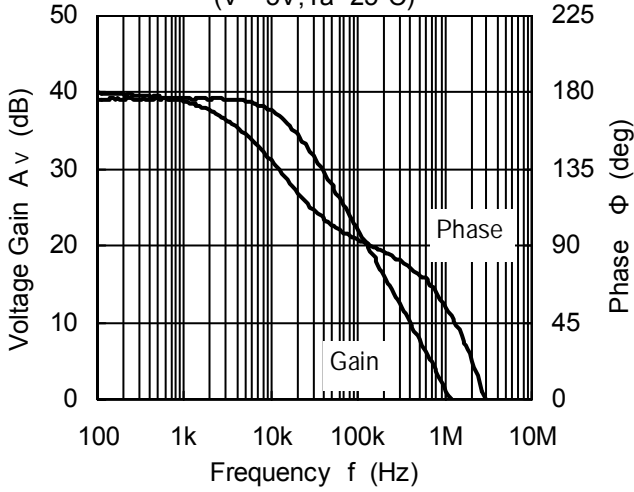

Bch Voltage Gain · Phase vs. Frequency  
( $V^+ = 5V, T_a = 25^\circ C$ )

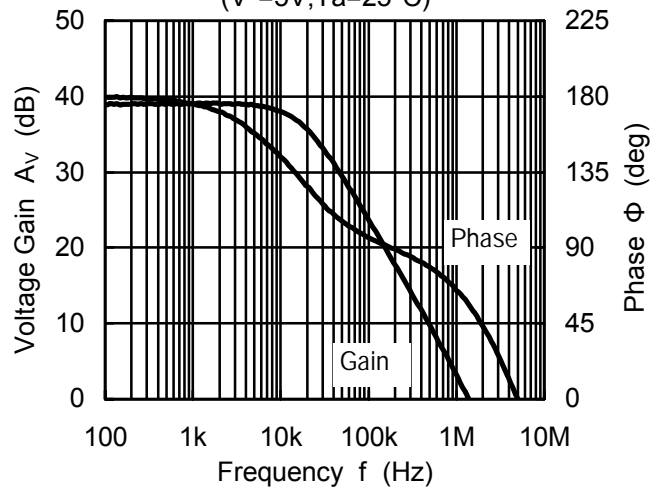

Operating Current vs. Operating Voltage  
( $I_{PC} = \text{off}, T_a = 25^\circ C$ )

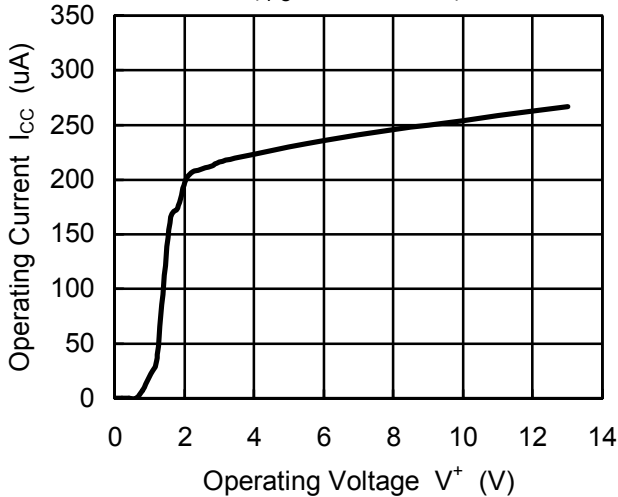

Reference Voltage vs. Operating Voltage  
( $I_{REF} = 0mA, T_a = 25^\circ C$ )

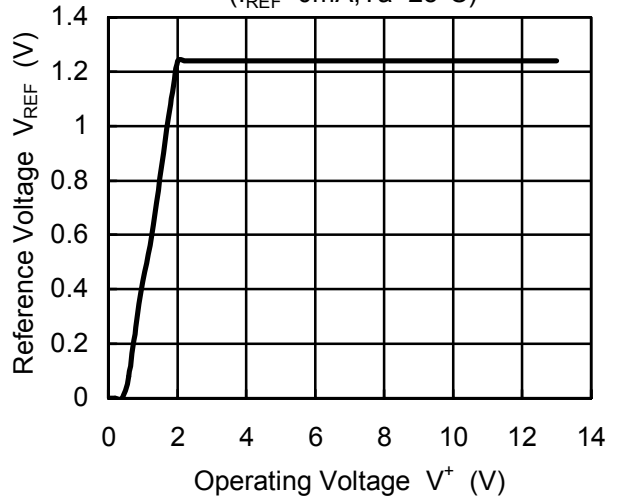

Saturation Voltage vs. PC Terminal Current  
( $V^+ = 5V, T_a = 25^\circ C$ )

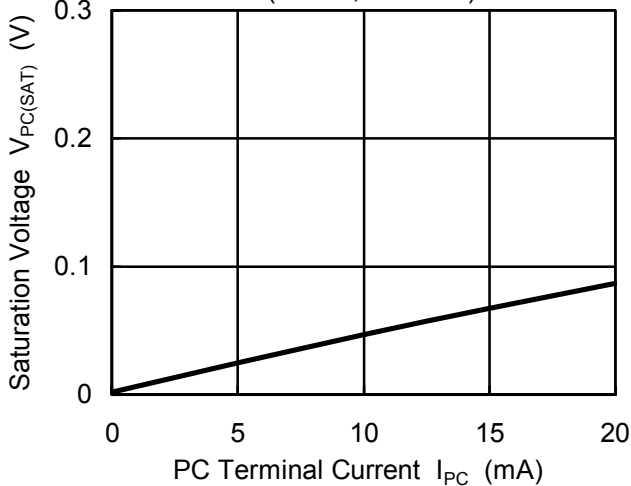

Reference Voltage vs. 7pin Output Current  
( $V^+ = 5V, T_a = 25^\circ C$ )

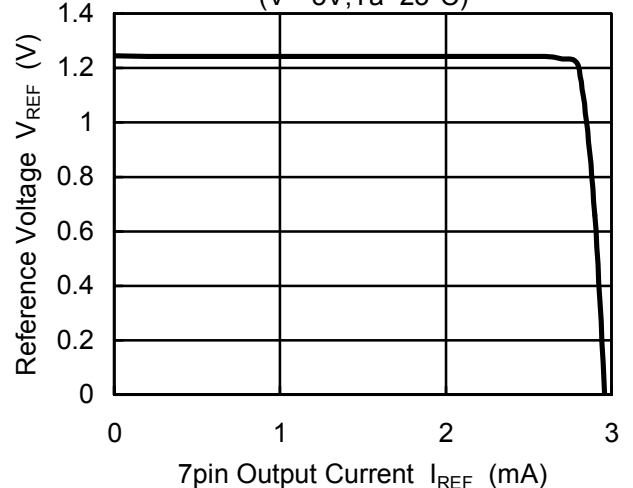

## ■ TYPICAL CHARACTERISTICS

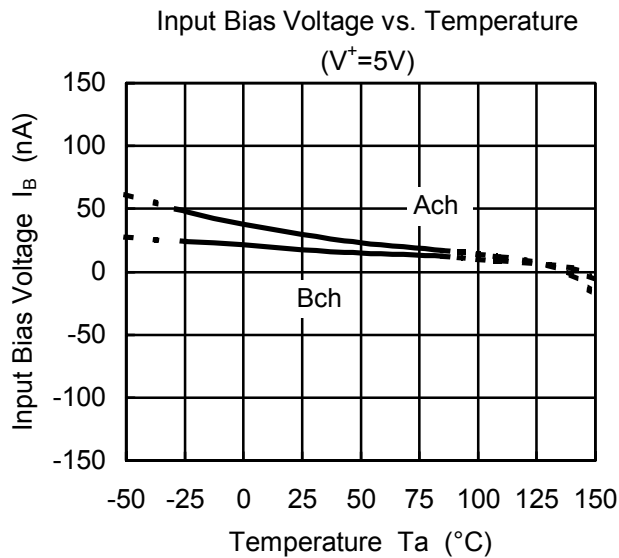
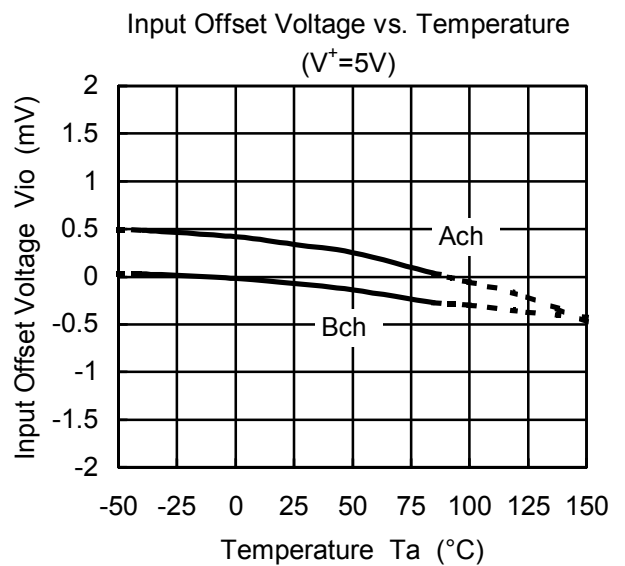
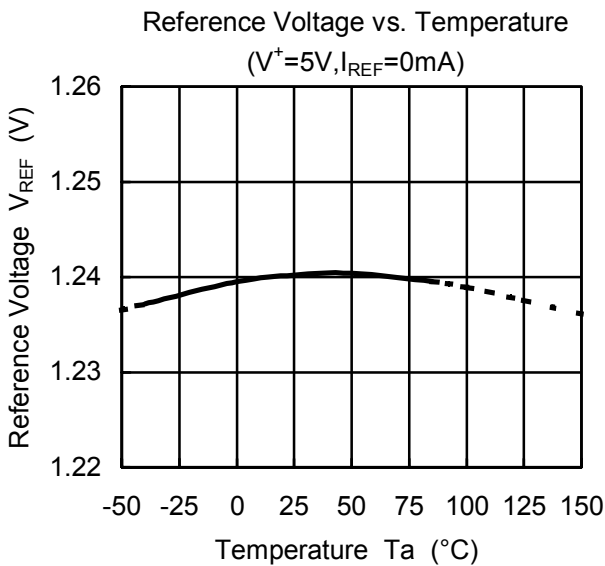
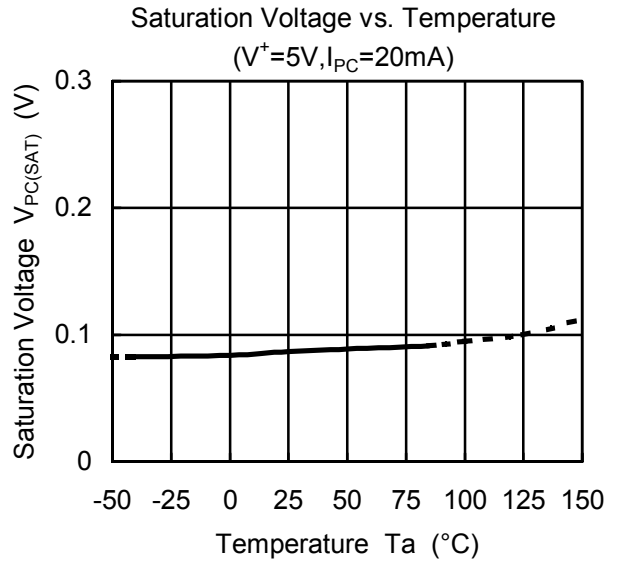
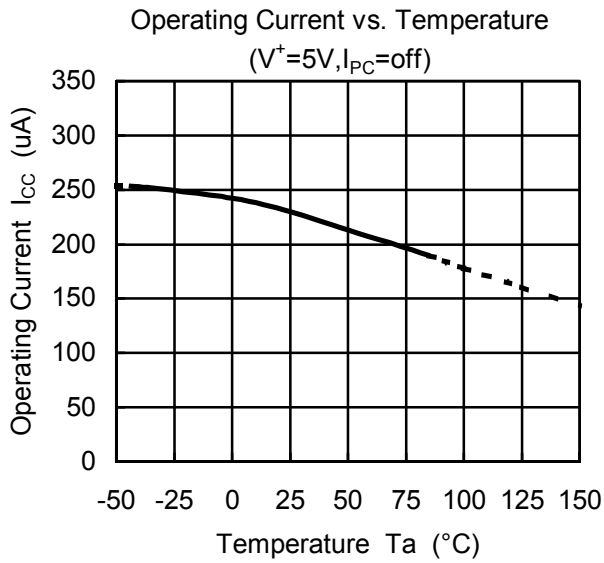

[CAUTION]  
The specifications on this databook are only given for information, without any guarantee as regards either mistakes or omissions. The application circuits in this databook are described only to show representative usages of the product and not intended for the guarantee or permission of any right including the industrial rights.

## Данный компонент на территории Российской Федерации

### Вы можете приобрести в компании MosChip.

Для оперативного оформления запроса Вам необходимо перейти по данной ссылке:

<http://moschip.ru/get-element>

Вы можете разместить у нас заказ для любого Вашего проекта, будь то серийное производство или разработка единичного прибора.

В нашем ассортименте представлены ведущие мировые производители активных и пассивных электронных компонентов.

Нашей специализацией является поставка электронной компонентной базы двойного назначения, продукции таких производителей как XILINX, Intel (ex.ALTERA), Vicor, Microchip, Texas Instruments, Analog Devices, Mini-Circuits, Amphenol, Glenair.

Сотрудничество с глобальными дистрибьюторами электронных компонентов, предоставляет возможность заказывать и получать с международных складов практически любой перечень компонентов в оптимальные для Вас сроки.

На всех этапах разработки и производства наши партнеры могут получить квалифицированную поддержку опытных инженеров.

Система менеджмента качества компании отвечает требованиям в соответствии с ГОСТ Р ИСО 9001, ГОСТ РВ 0015-002 и ЭС РД 009

### Офис по работе с юридическими лицами:

105318, г.Москва, ул.Щербаковская д.3, офис 1107, 1118, ДЦ «Щербаковский»

Телефон: +7 495 668-12-70 (многоканальный)

Факс: +7 495 668-12-70 (доб.304)

E-mail: [info@moschip.ru](mailto:info@moschip.ru)

Skype отдела продаж:

moschip.ru

moschip.ru\_4

moschip.ru\_6

moschip.ru\_9