

HiPerFAST™

High Speed IGBT

C2-Class w/ Diode

IXGK50N60C2D1
IXGX50N60C2D1

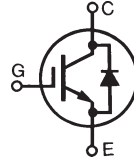

$V_{CES} = 600V$
 $I_{C110} = 50A$
 $V_{CE(sat)} \leq 2.7V$
 $t_{fi(typ)} = 48ns$

Symbol	Test Conditions	Maximum Ratings	
V_{CES}	$T_J = 25^\circ C$ to $150^\circ C$	600	V
V_{CGR}	$T_J = 25^\circ C$ to $150^\circ C$, $R_{GE} = 1M\Omega$	600	V
V_{GES}	Continuous	± 20	V
V_{GEM}	Transient	± 30	V
I_{C25}	$T_C = 25^\circ C$ (Limited by Leads)	75	A
I_{C110}	$T_C = 110^\circ C$	50	A
I_{F110}	$T_C = 110^\circ C$	48	A
I_{CM}	$T_C = 25^\circ C$, 1ms	300	A
SSOA (RBSOA)	$V_{GE} = 15V$, $T_{VJ} = 125^\circ C$, $R_G = 10\Omega$ Clamped Inductive Load	$I_{CM} = 100$ $V_{CE} \leq V_{CES}$	A
P_C	$T_C = 25^\circ C$	480	W
T_J		-55 ... +150	$^\circ C$
T_{JM}		150	$^\circ C$
T_{stg}		-55 ... +150	$^\circ C$
M_d	Mounting Torque (TO-264)	1.13 / 10	Nm/lb.in
F_C	Mounting Force (PLUS247)	20..120 / 4.5..27	N/lb
T_L	Maximum Lead Temperature for Soldering	300	$^\circ C$
T_{SOLD}	1.6mm (0.062 in.) from Case for 10s	260	$^\circ C$
Weight	TO-264	10	g
	PLUS247	6	g

TO-264 (IXGK)

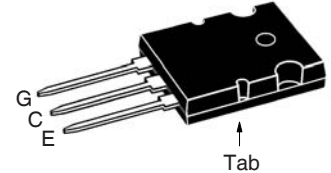

PLUS247 (IXGX)

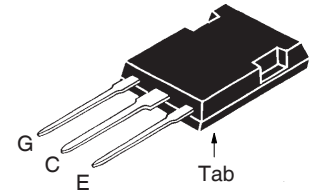

G = Gate E = Emitter
 C = Collector Tab = Collector

Features

- Very High Frequency IGBT
- Square RBSOA
- Anti-Parallel Ultra Fast Diode
- High Current Handling Capability

Advantages

- High Power Density
- Low Gate Drive Requirement

Applications

- Switch-Mode and Resonant-Mode Power Supplies
- Uninterruptible Power Supplies (UPS)
- PFC Circuits
- AC Motor Drives
- DC Servo & Robot Drives
- DC Choppers

Symbol	Test Conditions ($T_J = 25^\circ C$, Unless Otherwise Specified)	Characteristic Values		
		Min.	Typ.	Max.
$V_{GE(th)}$	$I_C = 250\mu A$, $V_{CE} = V_{GE}$	3.0		5.5 V
I_{CES}	$V_{CE} = V_{CES}$, $V_{GE} = 0V$ $T_J = 125^\circ C$			650 μA 5 mA
I_{GES}	$V_{CE} = 0V$, $V_{GE} = \pm 20V$			± 100 nA
$V_{CE(sat)}$	$I_C = 40A$, $V_{GE} = 15V$, Note 1 $T_J = 125^\circ C$		1.8	2.7 V V

Symbol Test Conditions

($T_J = 25^\circ\text{C}$ Unless Otherwise Specified)

Characteristic Values

Symbol	Test Conditions	Characteristic Values		
		Min.	Typ.	Max.
g_{fs}	$I_C = 40\text{A}, V_{CE} = 10\text{V}, \text{Note 1}$	40	51	S
C_{ies}	$V_{CE} = 25\text{V}, V_{GE} = 0\text{V}, f = 1\text{MHz}$		3700	pF
C_{oes}			290	pF
C_{res}			50	pF
$Q_{g(on)}$	$I_C = 40\text{A}, V_{GE} = 15\text{V}, V_{CE} = 0.5 \cdot V_{CES}$		138	nC
Q_{ge}			25	nC
Q_{gc}			40	nC
$t_{d(on)}$	Inductive load, $T_J = 25^\circ\text{C}$		18	ns
t_{ri}		$I_C = 40\text{A}, V_{GE} = 15\text{V}$	25	ns
$t_{d(off)}$	$V_{CE} = 0.8 \cdot V_{CES}, R_G = 2\Omega$		115	150 ns
t_{fi}		Note 2	48	ns
E_{off}		0.38	0.70	mJ
$t_{d(on)}$	Inductive load, $T_J = 125^\circ\text{C}$		18	ns
t_{ri}		$I_C = 40\text{A}, V_{GE} = 15\text{V}$	25	ns
E_{on}	$V_{CE} = 0.8 \cdot V_{CES}, R_G = 2\Omega$		1.4	mJ
$t_{d(off)}$		Note 2	170	ns
t_{fi}		60	ns	
E_{off}		0.74	mJ	
R_{thJC}			0.31	$^\circ\text{C/W}$
R_{thCS}		0.15		$^\circ\text{C/W}$

Reverse Diode (FRED)

Symbol Test Conditions

($T_J = 25^\circ\text{C}$ Unless Otherwise Specified)

Characteristic Values

Symbol	Test Conditions	Characteristic Values		
		Min.	Typ.	Max.
V_F	$I_F = 60\text{A}, V_{GE} = 0\text{V}, \text{Note 1}$			2.1 V
			$T_J = 150^\circ\text{C}$	1.4 V
I_{RM}	$I_F = 60\text{A}, V_{GE} = 0\text{V}, -di_F/dt = 100\text{A}/\mu\text{s}, T_J = 100^\circ\text{C}$			8.3 A
	$V_R = 100\text{V}$			
t_{rr}	$I_F = 1\text{A}, -di/dt = 200\text{A}/\mu\text{s}, V_R = 30\text{V}$		35	ns
R_{thJC}				0.65 $^\circ\text{C/W}$

Notes:

1. Pulse test, $t \leq 300\mu\text{s}$, duty cycle, $d \leq 2\%$.
2. Switching times & energy losses may increase for higher $V_{CE}(\text{clamp})$, T_J or R_G .

TO-264 Outline

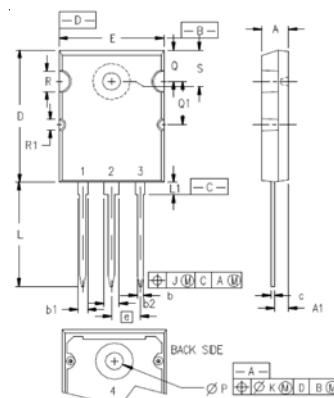

Terminals: 1 = Gate
2,4 = Collector
3 = Emitter

SYM	INCHES		MILLIMETERS	
	MIN	MAX	MIN	MAX
A	.185	.209	4.70	5.31
A1	.102	.118	2.59	3.00
b	.037	.055	0.94	1.40
b1	.087	.102	2.21	2.59
b2	.110	.126	2.79	3.20
c	.017	.029	0.43	0.74
D	1.007	1.047	25.58	26.59
E	.760	.799	19.30	20.29
e	.215 BSC		5.46 BSC	
J	.000	.010	0.00	0.25
K	.000	.010	0.00	0.25
L	.779	.842	19.79	21.39
L1	.087	.102	2.21	2.59
ØP	.122	.138	3.10	3.51
Q	.240	.256	6.10	6.50
Q1	.330	.346	8.38	8.79
ØR	.155	.187	3.94	4.75
ØR1	.085	.093	2.16	2.36
S	.243	.253	6.17	6.43

PLUS247™ Outline

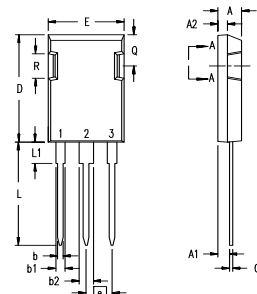

Terminals: 1 - Gate
2 - Collector
3 - Emitter

Dim.	Millimeter		Inches	
	Min.	Max.	Min.	Max.
A	4.83	5.21	.190	.205
A ₁	2.29	2.54	.090	.100
A ₂	1.91	2.16	.075	.085
b	1.14	1.40	.045	.055
b ₁	1.91	2.13	.075	.084
b ₂	2.92	3.12	.115	.123
C	0.61	0.80	.024	.031
D	20.80	21.34	.819	.840
E	15.75	16.13	.620	.635
e	5.45 BSC		.215 BSC	
L	19.81	20.32	.780	.800
L1	3.81	4.32	.150	.170
Q	5.59	6.20	.220	0.244
R	4.32	4.83	.170	.190

IXYS Reserves the Right to Change Limits, Test conditions, and Dimensions.

IXYS MOSFETs and IGBTs are covered by one or more of the following U.S. patents:	4,835,592	4,931,844	5,049,961	5,237,481	6,162,665	6,404,065 B1	6,683,344	6,727,585	7,005,734 B2	7,157,338 B2
	4,860,072	5,017,508	5,063,307	5,381,025	6,259,123 B1	6,534,343	6,710,405 B2	6,759,692	7,063,975 B2	
	4,881,106	5,034,796	5,187,117	5,486,715	6,306,728 B1	6,583,505	6,710,463	6,771,478 B2	7,071,537	

Fig. 1. Output Characteristics
@ $T_J = 25^\circ\text{C}$

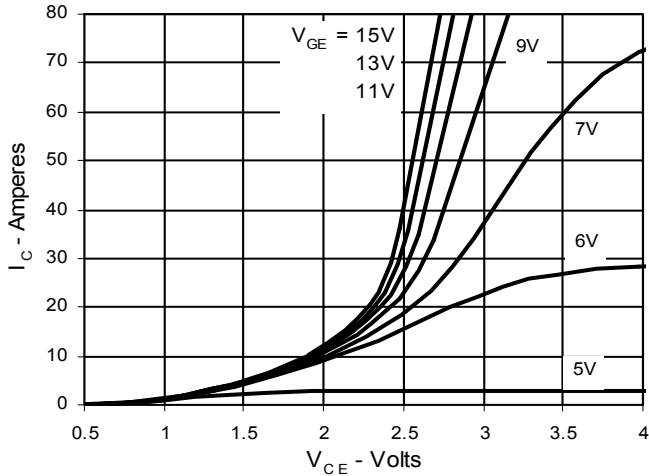

Fig. 2. Extended Output Characteristics
@ $T_J = 25^\circ\text{C}$

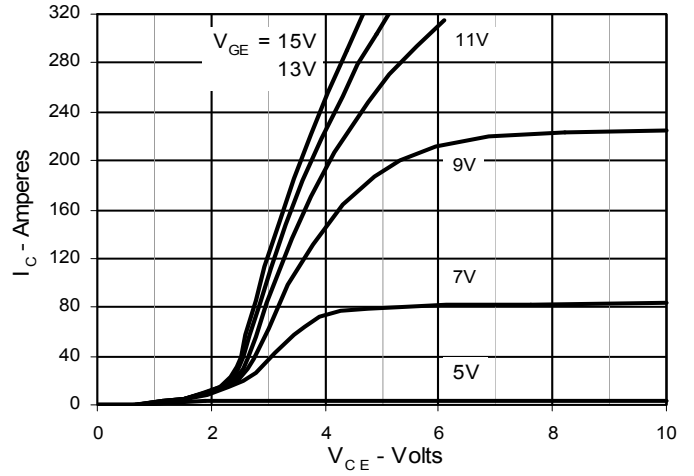

Fig. 3. Output Characteristics
@ $T_J = 125^\circ\text{C}$

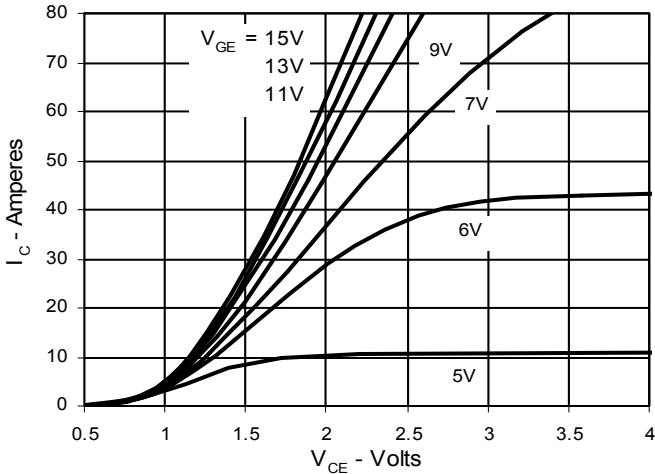

Fig. 4. Dependence of $V_{CE(sat)}$ on Temperature

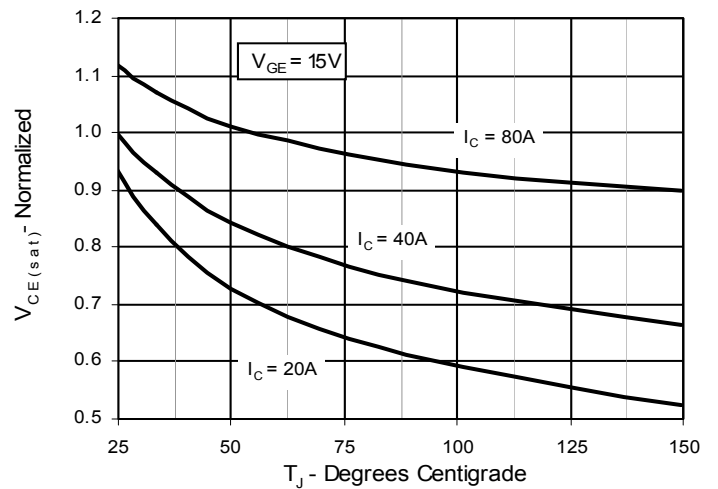

Fig. 5. Collector-to-Emitter Voltage vs. Gate-to-Emitter voltage

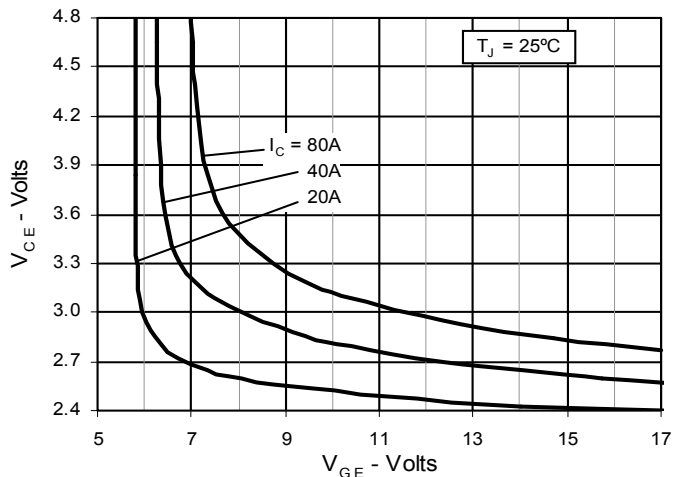

Fig. 6. Input Admittance

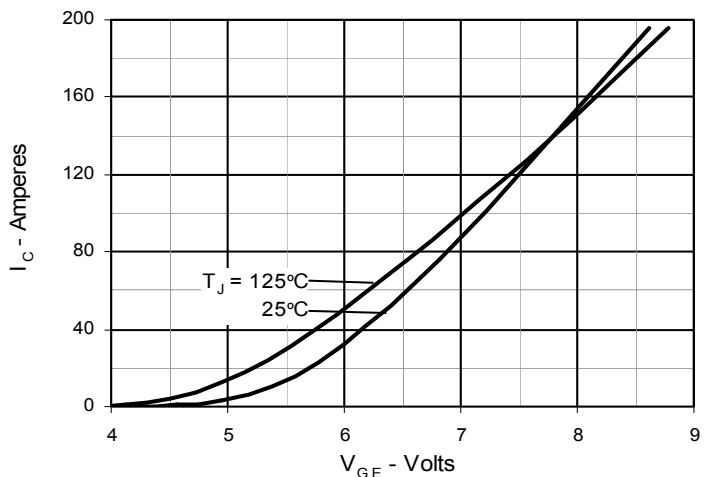

Fig. 7. Transconductance

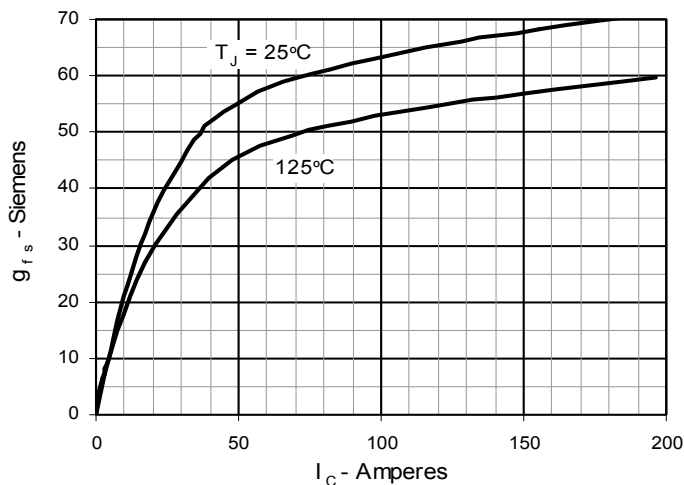

Fig. 8. Dependence of Turn-Off Energy on R_G

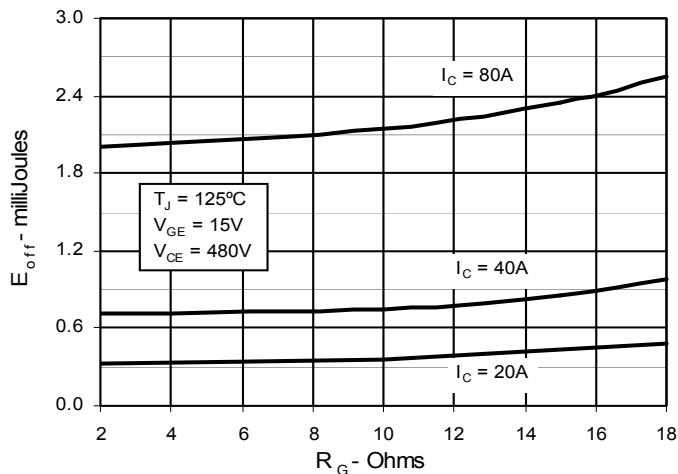

Fig. 9. Dependence of Turn-Off Energy on I_C

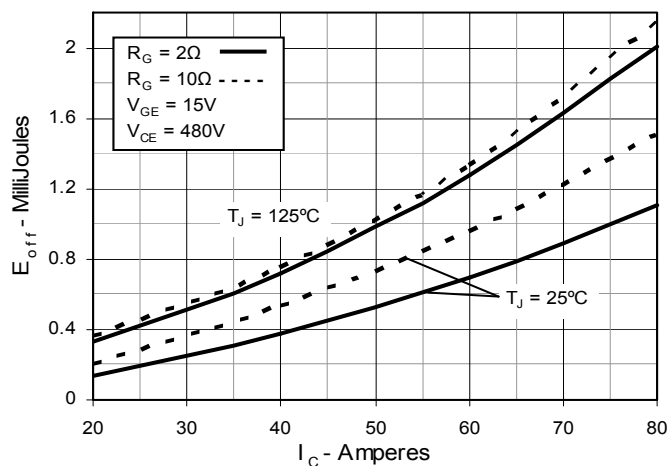

Fig. 10. Dependence of Turn-Off Energy on Temperature

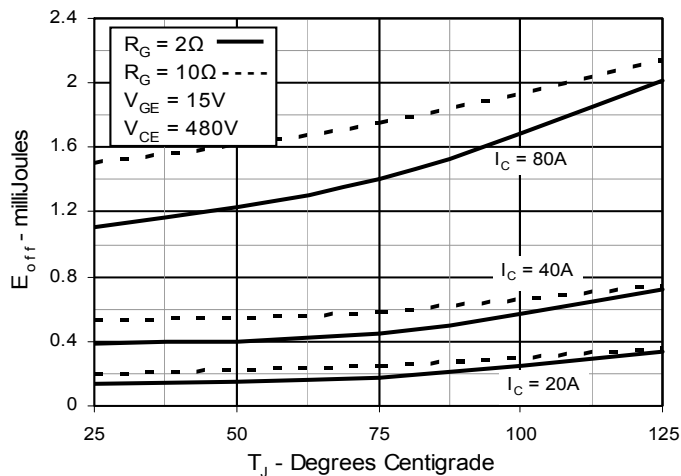

Fig. 11. Dependence of Turn-Off Switching Time on R_G

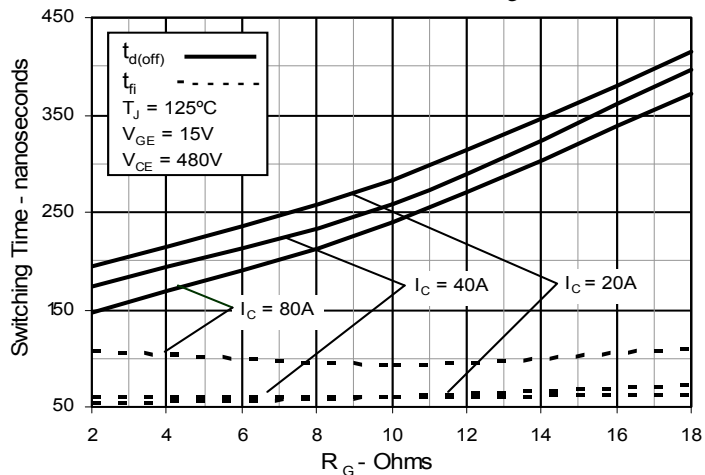

Fig. 12. Dependence of Turn-Off Switching Time on I_C

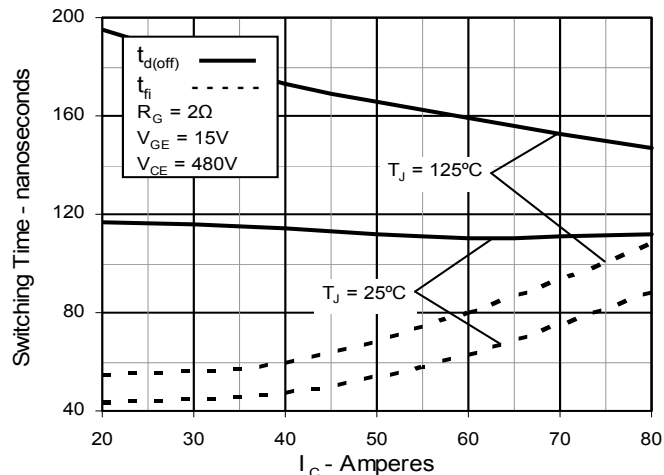

Fig. 13. Dependence of Turn-Off Switching Time on Temperature

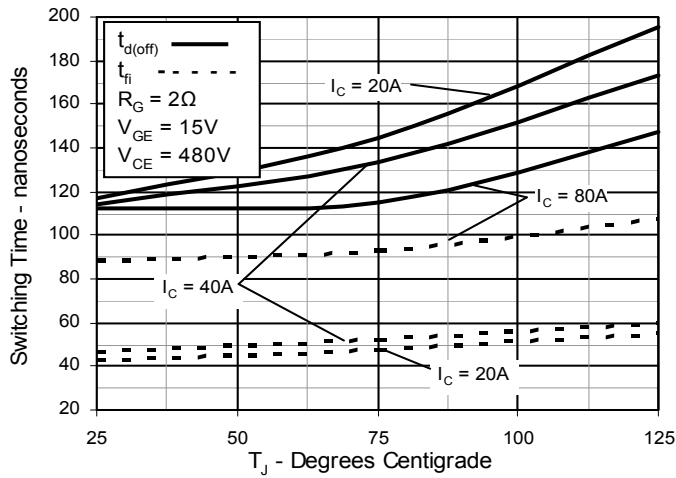

Fig. 14. Reverse-Bias Safe Operating Area

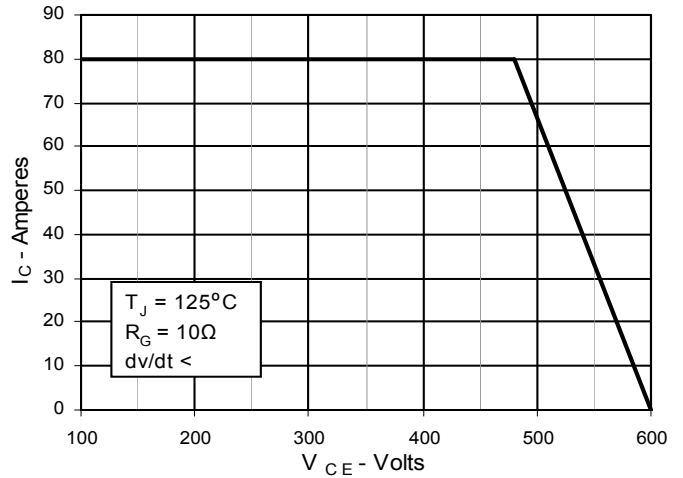

Fig. 15. Gate Charge

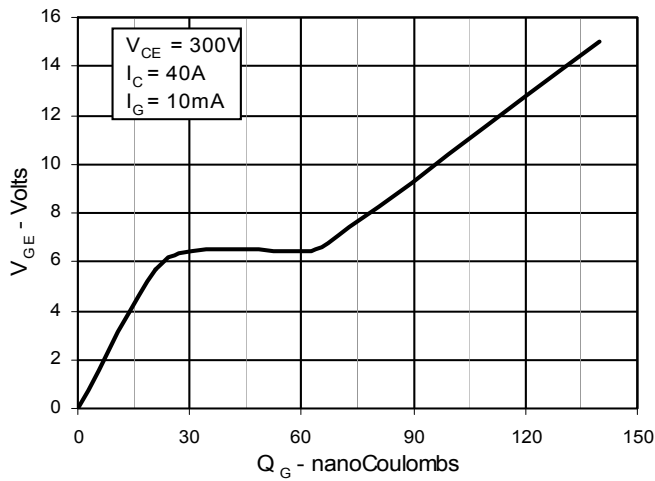

Fig. 16. Capacitance

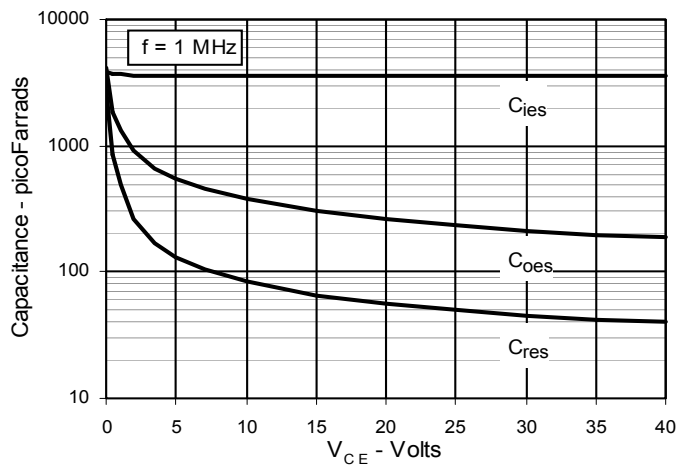
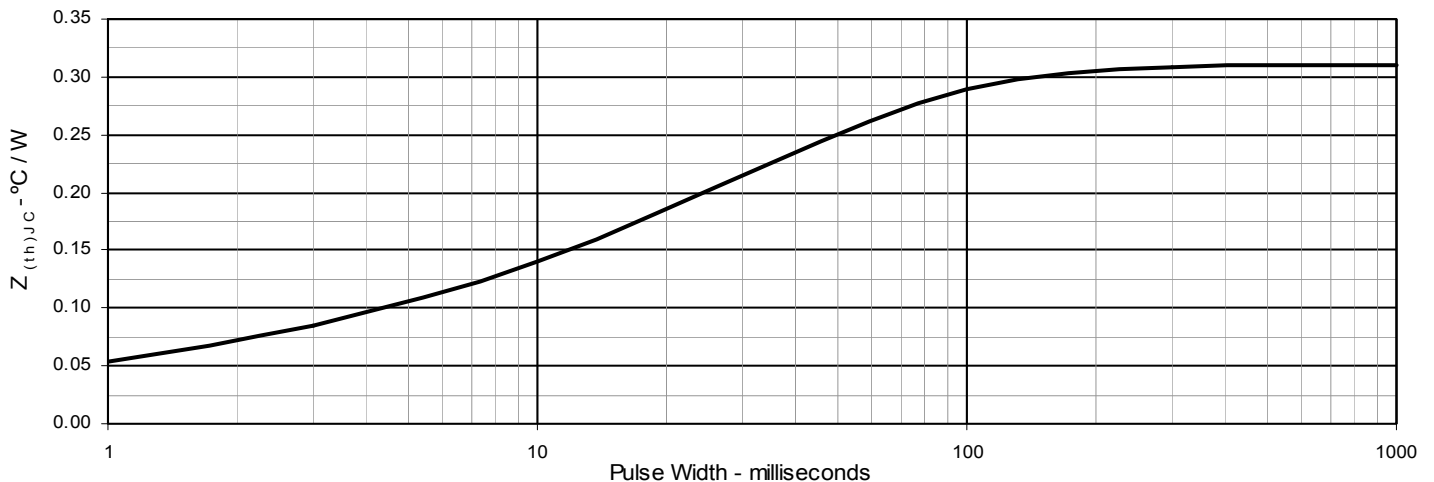

Fig. 17. Maximum Transient Thermal Resistance



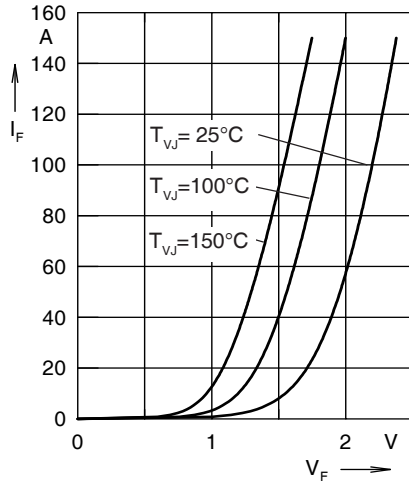

Fig. 18. Forward current I_F versus V_F

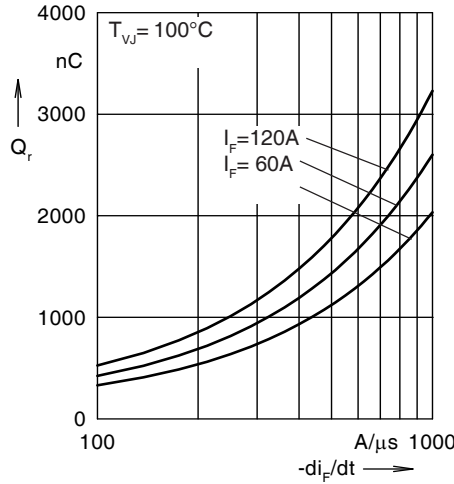

Fig. 19. Reverse recovery charge Q_r

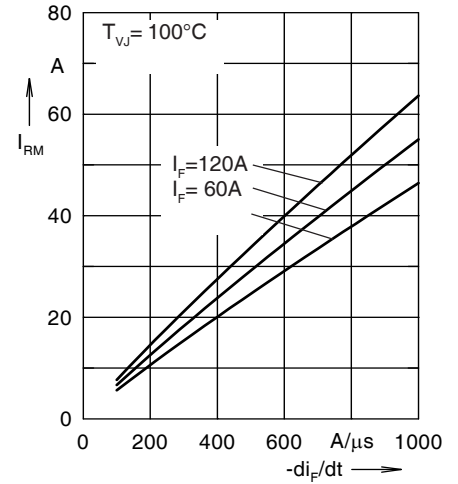

Fig. 20. Peak reverse current I_{RM}

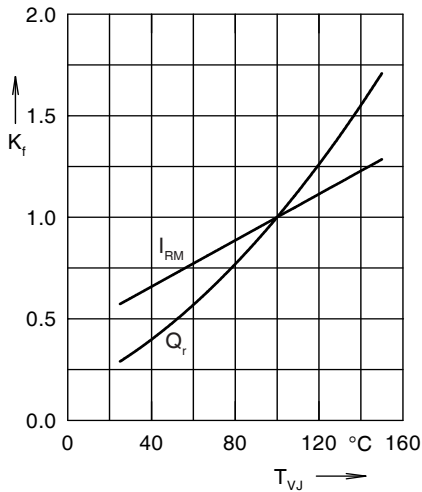

Fig. 21. Dynamic parameters Q_r , I_{RM}

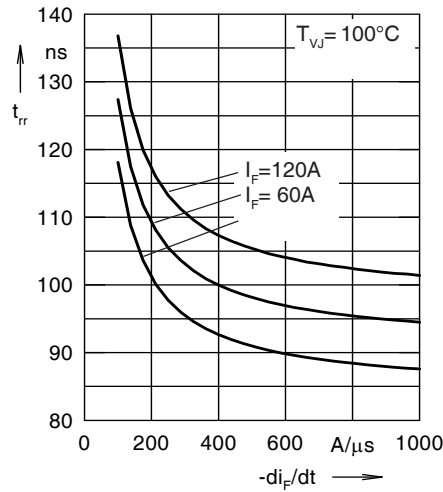

Fig. 22. Recovery time t_{rr} versus $-di_F/dt$

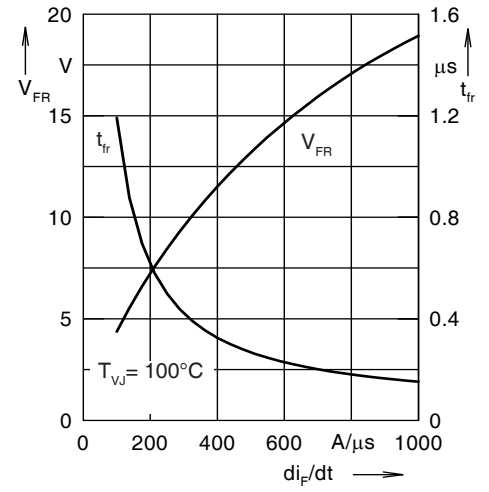

Fig. 23. Peak forward voltage V_{FR} and t_{rr}

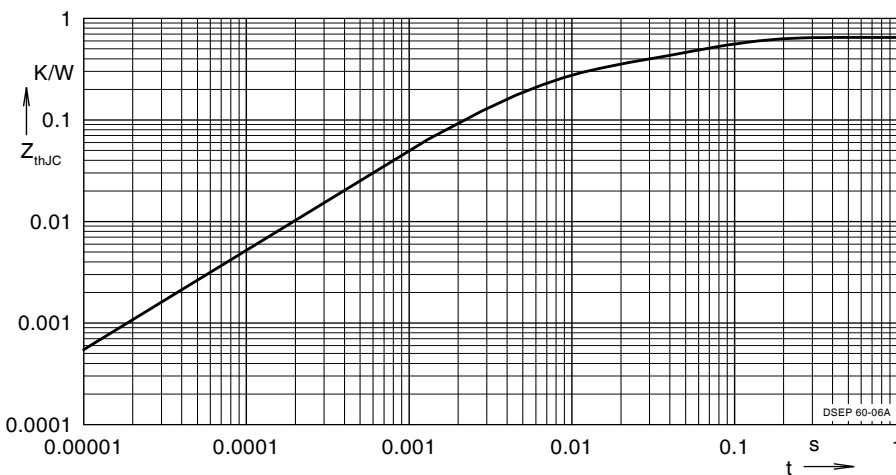

Fig. 24. Transient thermal resistance junction to case

Constants for Z_{thJC} calculation:

i	R_{thi} (K/W)	t_i (s)
1	0.324	0.0052
2	0.125	0.0003

Note: Fig. 2 through Fig. 6 show typical

Данный компонент на территории Российской Федерации

Вы можете приобрести в компании MosChip.

Для оперативного оформления запроса Вам необходимо перейти по данной ссылке:

<http://moschip.ru/get-element>

Вы можете разместить у нас заказ для любого Вашего проекта, будь то серийное производство или разработка единичного прибора.

В нашем ассортименте представлены ведущие мировые производители активных и пассивных электронных компонентов.

Нашей специализацией является поставка электронной компонентной базы двойного назначения, продукции таких производителей как XILINX, Intel (ex.ALTERA), Vicor, Microchip, Texas Instruments, Analog Devices, Mini-Circuits, Amphenol, Glenair.

Сотрудничество с глобальными дистрибьюторами электронных компонентов, предоставляет возможность заказывать и получать с международных складов практически любой перечень компонентов в оптимальные для Вас сроки.

На всех этапах разработки и производства наши партнеры могут получить квалифицированную поддержку опытных инженеров.

Система менеджмента качества компании отвечает требованиям в соответствии с ГОСТ Р ИСО 9001, ГОСТ РВ 0015-002 и ЭС РД 009

Офис по работе с юридическими лицами:

105318, г.Москва, ул.Щербаковская д.3, офис 1107, 1118, ДЦ «Щербаковский»

Телефон: +7 495 668-12-70 (многоканальный)

Факс: +7 495 668-12-70 (доб.304)

E-mail: info@moschip.ru

Skype отдела продаж:

moschip.ru

moschip.ru_4

moschip.ru_6

moschip.ru_9