



RF Power LDMOS Transistors

N-Channel Enhancement-Mode Lateral MOSFETs

These 32 W RF power LDMOS transistors are designed for cellular base station applications requiring very wide instantaneous bandwidth capability covering the frequency range of 1805 to 1880 MHz.

1800 MHz

- Typical Single-Carrier W-CDMA Performance: $V_{DD} = 28$ Vdc, $I_{DQ} = 1000$ mA, $P_{out} = 32$ W Avg., Input Signal PAR = 9.9 dB @ 0.01% Probability on CCDF.

Frequency	G_{ps} (dB)	η_D (%)	Output PAR (dB)	ACPR (dBc)	IRL (dB)
1805 MHz	19.2	33.0	7.1	-34.8	-10
1840 MHz	20.1	33.9	7.0	-34.6	-16
1880 MHz	19.6	34.2	6.8	-34.3	-8

Features

- Designed for Wide Instantaneous Bandwidth Applications
- Greater Negative Gate-Source Voltage Range for Improved Class C Operation
- Able to Withstand Extremely High Output VSWR and Broadband Operating Conditions
- Optimized for Doherty Applications

A2T18S162W31SR3
A2T18S162W31GSR3

1805–1880 MHz, 32 W AVG., 28 V
AIRFAST RF POWER LDMOS
TRANSISTORS

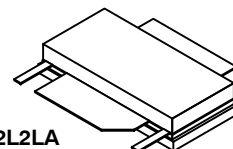

NI-780S-2L2LA
A2T18S162W31SR3

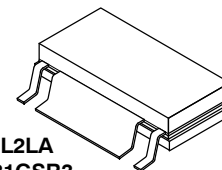

NI-780GS-2L2LA
A2T18S162W31GSR3

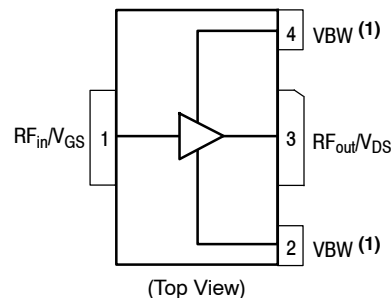

Figure 1. Pin Connections

- Device can operate with the V_{DD} current supplied through pin 2 or pin 4 alone.

Table 1. Maximum Ratings

Rating	Symbol	Value	Unit
Drain-Source Voltage	V_{DSS}	-0.5, +65	Vdc
Gate-Source Voltage	V_{GS}	-6.0, +10	Vdc
Operating Voltage	V_{DD}	32, +0	Vdc
Storage Temperature Range	T_{stg}	-65 to +150	°C
Case Operating Temperature Range	T_C	-40 to +125	°C
Operating Junction Temperature Range (1,2)	T_J	-40 to +225	°C
CW Operation @ $T_C = 25^\circ\text{C}$ Derate above 25°C	CW	185 1.0	W W/°C

Table 2. Thermal Characteristics

Characteristic	Symbol	Value (2,3)	Unit
Thermal Resistance, Junction to Case Case Temperature 76°C, 32 W CW, 28 Vdc, $I_{DQ} = 1000$ mA, 1840 MHz	$R_{\theta JC}$	0.36	°C/W

Table 3. ESD Protection Characteristics

Test Methodology	Class
Human Body Model (per JESD22-A114)	2
Machine Model (per EIA/JESD22-A115)	B
Charge Device Model (per JESD22-C101)	IV

Table 4. Electrical Characteristics ($T_A = 25^\circ\text{C}$ unless otherwise noted)

Characteristic	Symbol	Min	Typ	Max	Unit
----------------	--------	-----	-----	-----	------

Off Characteristics

Zero Gate Voltage Drain Leakage Current ($V_{DS} = 65$ Vdc, $V_{GS} = 0$ Vdc)	I_{DSS}	—	—	10	μAdc
Zero Gate Voltage Drain Leakage Current ($V_{DS} = 32$ Vdc, $V_{GS} = 0$ Vdc)	I_{DSS}	—	—	5	μAdc
Gate-Source Leakage Current ($V_{GS} = 5$ Vdc, $V_{DS} = 0$ Vdc)	I_{GSS}	—	—	1	μAdc

On Characteristics

Gate Threshold Voltage ($V_{DS} = 10$ Vdc, $I_D = 160$ μAdc)	$V_{GS(th)}$	1.2	1.9	2.2	Vdc
Gate Quiescent Voltage ($V_{DD} = 28$ Vdc, $I_D = 1000$ mAdc, Measured in Functional Test)	$V_{GS(Q)}$	2.1	2.7	3.1	Vdc
Drain-Source On-Voltage ($V_{GS} = 10$ Vdc, $I_D = 1.6$ Adc)	$V_{DS(on)}$	0.1	0.14	0.3	Vdc

Functional Tests (4,5) (In Freescale Test Fixture, 50 ohm system) $V_{DD} = 28$ Vdc, $I_{DQ} = 1000$ mA, $P_{out} = 32$ W Avg., $f = 1840$ MHz, Single-Carrier W-CDMA, IQ Magnitude Clipping, Input Signal PAR = 9.9 dB @ 0.01% Probability on CCDF. ACPR measured in 3.84 MHz Channel Bandwidth @ ± 5 MHz Offset.

Power Gain	G_{ps}	18.5	20.1	21.5	dB
Drain Efficiency	η_D	26.0	33.9	—	%
Output Peak-to-Average Ratio @ 0.01% Probability on CCDF	PAR	6.6	7.0	—	dB
Adjacent Channel Power Ratio	ACPR	—	-34.6	-32.0	dBc
Input Return Loss	IRL	—	-16	-12	dB

1. Continuous use at maximum temperature will affect MTTF.
2. MTTF calculator available at <http://www.freescale.com/rf/calculators>.
3. Refer to [AN1955](#), *Thermal Measurement Methodology of RF Power Amplifiers*. Go to <http://www.freescale.com/rf> and search for AN1955.
4. Part internally matched both on input and output.
5. Measurements made with device in straight lead configuration, before any lead forming operation is applied. Lead forming is used for gull wing (GS) parts. (continued)

Table 4. Electrical Characteristics ($T_A = 25^\circ\text{C}$ unless otherwise noted) (continued)

Characteristic	Symbol	Min	Typ	Max	Unit
Load Mismatch (In Freescale Test Fixture, 50 ohm system) $I_{DQ} = 1000\text{ mA}$, $f = 1840\text{ MHz}$					
VSWR 10:1 at 32 Vdc, 169 W CW Output Power (3 dB Input Overdrive from 129 W CW Rated Power)	No Device Degradation				
Typical Performance (In Freescale Test Fixture, 50 ohm system) $V_{DD} = 28\text{ Vdc}$, $I_{DQ} = 1000\text{ mA}$, 1805–1880 MHz Bandwidth					
P_{out} @ 1 dB Compression Point, CW	P1dB	—	129	—	W
AM/PM (Maximum value measured at the P3dB compression point across the 1805–1880 MHz frequency range.)	Φ	—	-16	—	°
VBW Resonance Point (IMD Third Order Intermodulation Inflection Point)	VBW _{res}	—	110	—	MHz
Gain Flatness in 75 MHz Bandwidth @ $P_{out} = 32\text{ W Avg.}$	G_F	—	0.7	—	dB
Gain Variation over Temperature (-30°C to +85°C)	ΔG	—	0.006	—	dB/°C
Output Power Variation over Temperature (-30°C to +85°C) (1)	$\Delta P1dB$	—	0.005	—	dB/°C

Table 5. Ordering Information

Device	Tape and Reel Information	Package
A2T18S162W31SR3	R3 Suffix = 250 Units, 44 mm Tape Width, 13-inch Reel	NI-780S-2L2LA
A2T18S162W31GSR3		NI-780GS-2L2LA

1. Exceeds recommended operating conditions. See CW operation data in Maximum Ratings table.

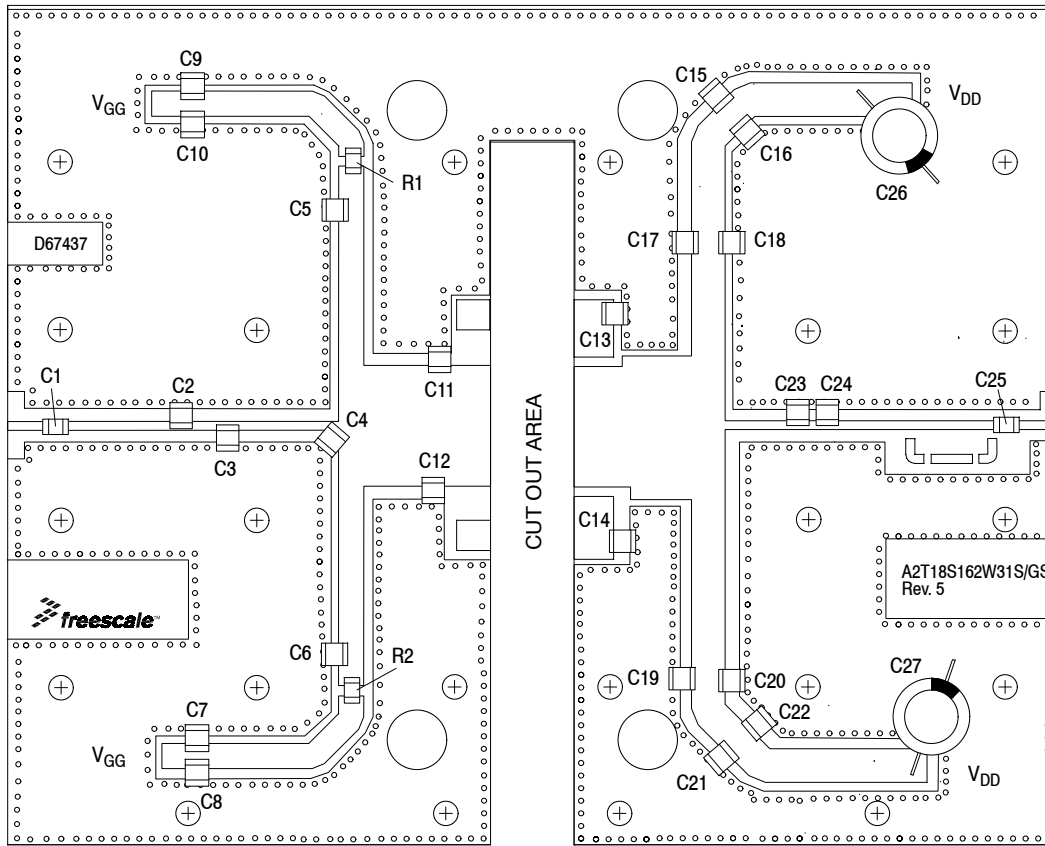

Figure 2. A2T18S162W31SR3 Test Circuit Component Layout

Table 6. A2T18S162W31SR3 Test Circuit Component Designations and Values

Part	Description	Part Number	Manufacturer
C1, C5, C6, C17, C18, C19, C20, C25	8.2 pF Chip Capacitors	ATC100B8R2CT500XT	ATC
C2	0.2 pF Chip Capacitor	ATC100B0R2BT500XT	ATC
C3	1.1 pF Chip Capacitor	ATC100B1R1BT500XT	ATC
C4	0.3 pF Chip Capacitor	ATC100B0R3BT500XT	ATC
C7, C8, C9, C10, C13, C14, C15, C16, C21, C22	10 μ F Chip Capacitors	GRM32ER61H106KA12L	Murata
C11, C12	1.0 pF Chip Capacitors	ATC100B1R0BT500XT	ATC
C23	2.0 pF Chip Capacitor	ATC100B2R0BT500XT	ATC
C24	0.5 pF Chip Capacitor	ATC100B0R5BT500XT	ATC
C26, C27	470 μ F, 63 V Electrolytic Capacitors	MCGPR63V477M13X26	Multicom
R1, R2	2.37 Ω , 1/4 W Chip Resistors	CRCW12062R37FNEA	Vishay
PCB	Rogers RO4350B, 0.020", $\epsilon_r = 3.66$	D67437	MTL

TYPICAL CHARACTERISTICS

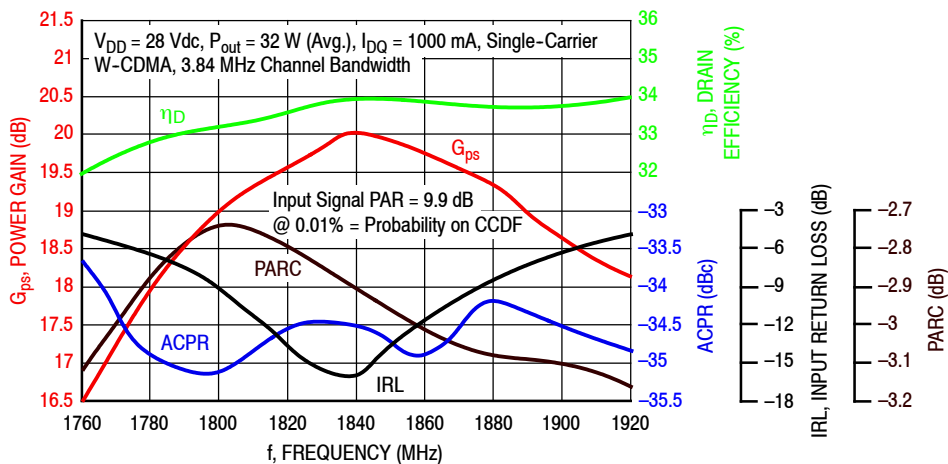

Figure 3. Single-Carrier Output Peak-to-Average Ratio Compression (PARC) Broadband Performance @ $P_{out} = 32$ Watts Avg.

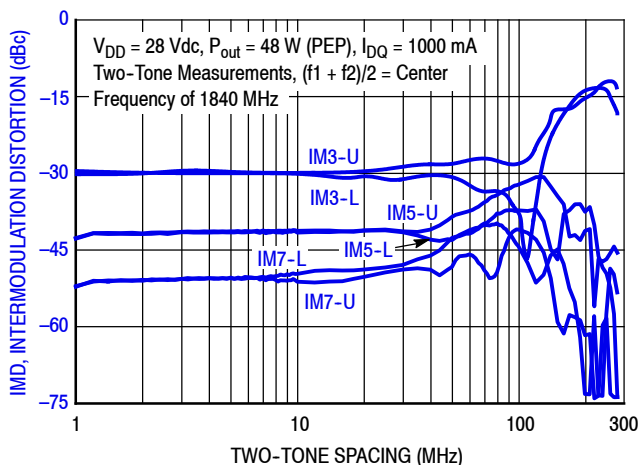

Figure 4. Intermodulation Distortion Products versus Two-Tone Spacing

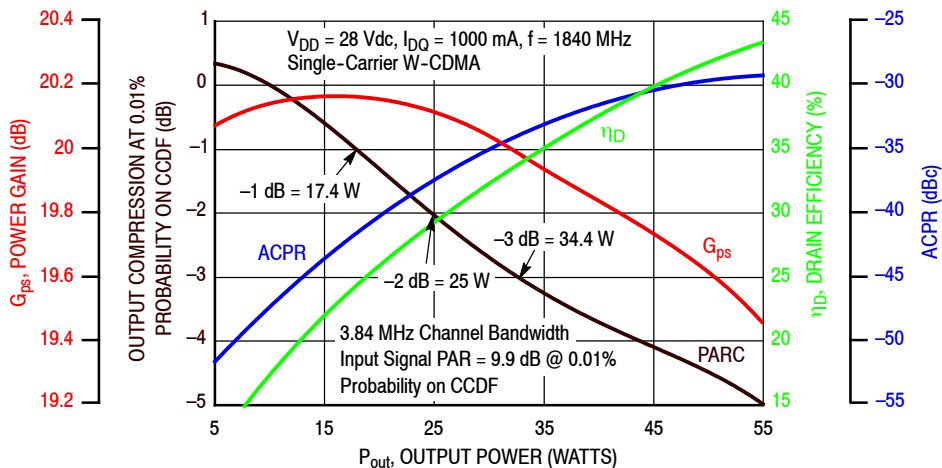

Figure 5. Output Peak-to-Average Ratio Compression (PARC) versus Output Power

TYPICAL CHARACTERISTICS

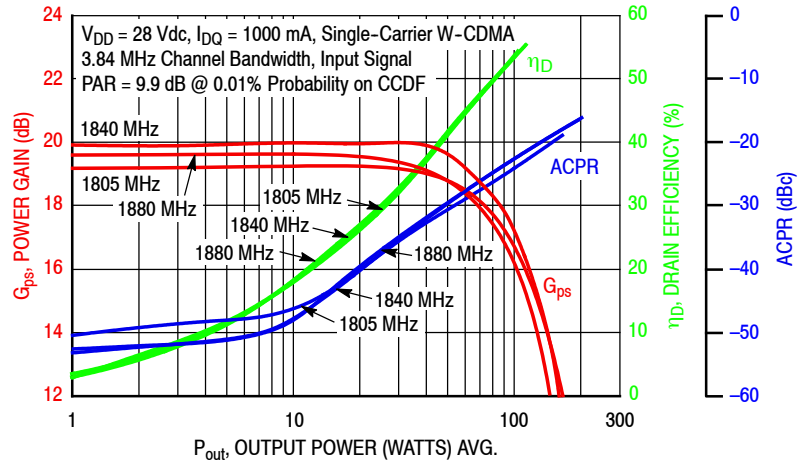

Figure 6. Single-Carrier W-CDMA Power Gain, Drain Efficiency and ACPR versus Output Power

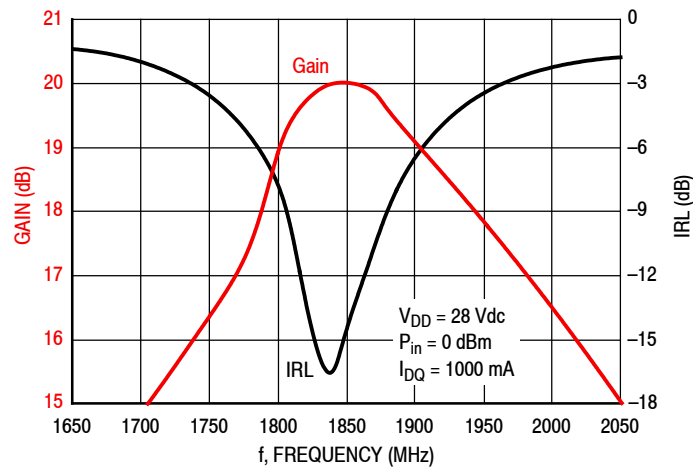

Figure 7. Broadband Frequency Response

Table 7. Load Pull Performance — Maximum Power Tuning
 $V_{DD} = 28 \text{ Vdc}$, $I_{DQ} = 1083 \text{ mA}$, Pulsed CW, 10 $\mu\text{sec}(\text{on})$, 10% Duty Cycle

f (MHz)	$Z_{\text{source}} (\Omega)$	$Z_{\text{in}} (\Omega)$	Max Output Power					
			P1dB					
			$Z_{\text{load}}^{(1)} (\Omega)$	Gain (dB)	(dBm)	(W)	η_D (%)	AM/PM (°)
1805	$0.48 - j2.25$	$0.52 + j2.43$	$2.23 - j3.56$	18.3	51.6	145	50.1	-9
1840	$0.59 - j2.30$	$0.58 + j2.50$	$2.09 - j3.66$	18.0	51.5	143	47.5	-9
1880	$0.56 - j2.51$	$0.57 + j2.65$	$1.55 - j2.49$	18.9	51.8	152	53.1	-9

f (MHz)	$Z_{\text{source}} (\Omega)$	$Z_{\text{in}} (\Omega)$	Max Output Power					
			P3dB					
			$Z_{\text{load}}^{(2)} (\Omega)$	Gain (dB)	(dBm)	(W)	η_D (%)	AM/PM (°)
1805	$0.48 - j2.25$	$0.46 + j2.49$	$2.16 - j3.48$	16.3	52.8	189	54.7	-13
1840	$0.59 - j2.30$	$0.51 + j2.56$	$2.13 - j3.47$	16.3	52.7	185	53.5	-13
1880	$0.56 - j2.51$	$0.53 + j2.71$	$1.71 - j2.74$	16.8	52.9	196	57.7	-14

(1) Load impedance for optimum P1dB power.

(2) Load impedance for optimum P3dB power.

 Z_{source} = Measured impedance presented to the input of the device at the package reference plane.

 Z_{in} = Impedance as measured from gate contact to ground.

 Z_{load} = Measured impedance presented to the output of the device at the package reference plane.

Table 8. Load Pull Performance — Maximum Drain Efficiency Tuning
 $V_{DD} = 28 \text{ Vdc}$, $I_{DQ} = 1083 \text{ mA}$, Pulsed CW, 10 $\mu\text{sec}(\text{on})$, 10% Duty Cycle

f (MHz)	$Z_{\text{source}} (\Omega)$	$Z_{\text{in}} (\Omega)$	Max Drain Efficiency					
			P1dB					
			$Z_{\text{load}}^{(1)} (\Omega)$	Gain (dB)	(dBm)	(W)	η_D (%)	AM/PM (°)
1805	$0.48 - j2.25$	$0.46 + j2.41$	$2.96 - j0.53$	21.9	49.6	91	61.6	-9
1840	$0.59 - j2.30$	$0.51 + j2.53$	$2.38 - j0.51$	22.0	49.6	91	61.8	-11
1880	$0.56 - j2.51$	$0.53 + j2.66$	$1.99 - j0.37$	22.5	49.3	85	65.0	-14

f (MHz)	$Z_{\text{source}} (\Omega)$	$Z_{\text{in}} (\Omega)$	Max Drain Efficiency					
			P3dB					
			$Z_{\text{load}}^{(2)} (\Omega)$	Gain (dB)	(dBm)	(W)	η_D (%)	AM/PM (°)
1805	$0.48 - j2.25$	$0.46 + j2.49$	$3.34 - j0.09$	20.3	50.4	110	67.7	-17
1840	$0.59 - j2.30$	$0.50 + j2.59$	$2.82 - j0.79$	19.8	51.0	125	66.9	-17
1880	$0.56 - j2.51$	$0.53 + j2.72$	$2.42 - j0.87$	19.9	51.0	126	68.4	-20

(1) Load impedance for optimum P1dB efficiency.

(2) Load impedance for optimum P3dB efficiency.

 Z_{source} = Measured impedance presented to the input of the device at the package reference plane.

 Z_{in} = Impedance as measured from gate contact to ground.

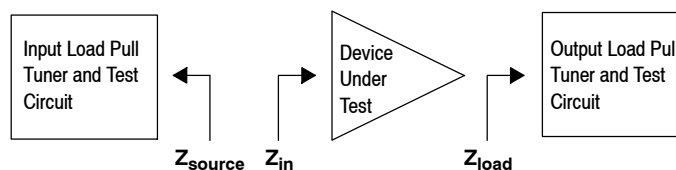
 Z_{load} = Measured impedance presented to the output of the device at the package reference plane.

P1dB – TYPICAL LOAD PULL CONTOURS — 1840 MHz

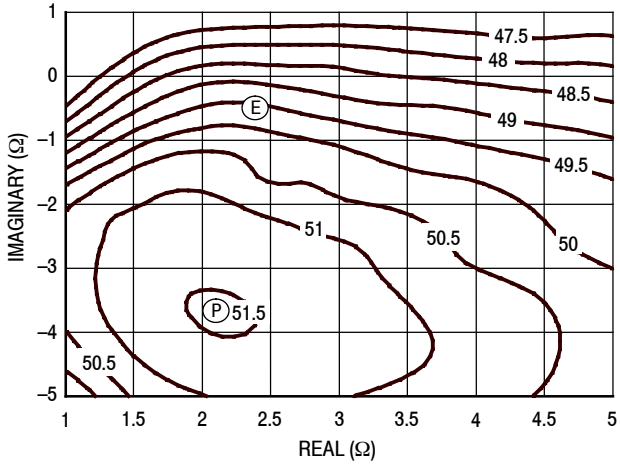

Figure 8. P1dB Load Pull Output Power Contours (dBm)

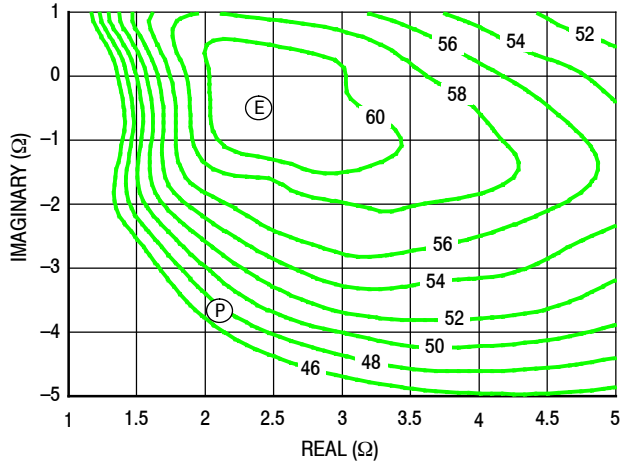

Figure 9. P1dB Load Pull Efficiency Contours (%)

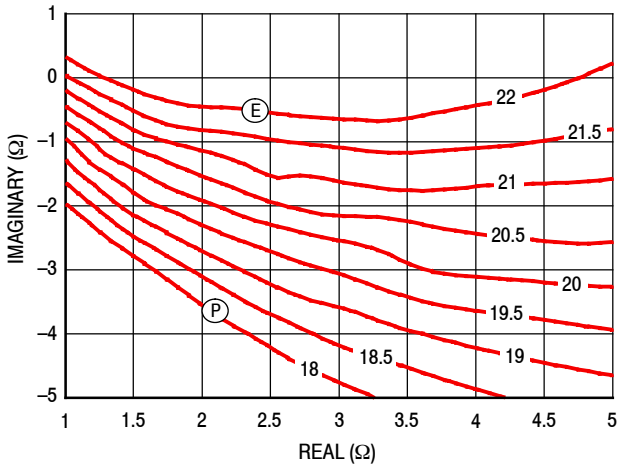

Figure 10. P1dB Load Pull Gain Contours (dB)

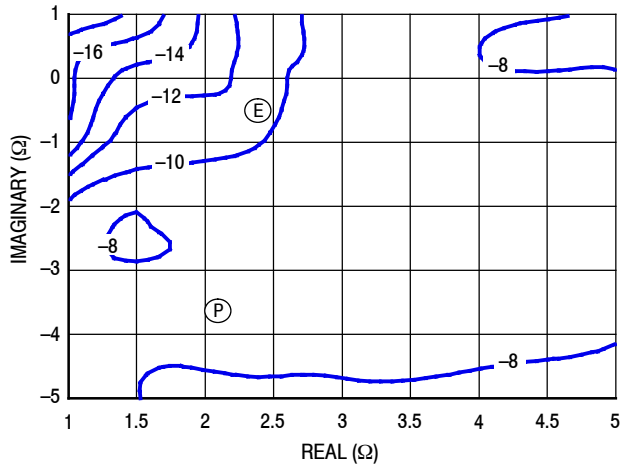

Figure 11. P1dB Load Pull AM/PM Contours (°)

NOTE: (P) = Maximum Output Power
 (E) = Maximum Drain Efficiency

- Gain
- Drain Efficiency
- Linearity
- Output Power

P3dB – TYPICAL LOAD PULL CONTOURS — 1840 MHz

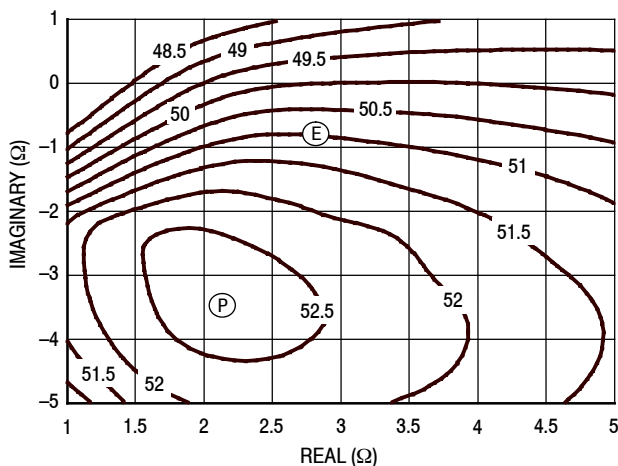

Figure 12. P3dB Load Pull Output Power Contours (dBm)

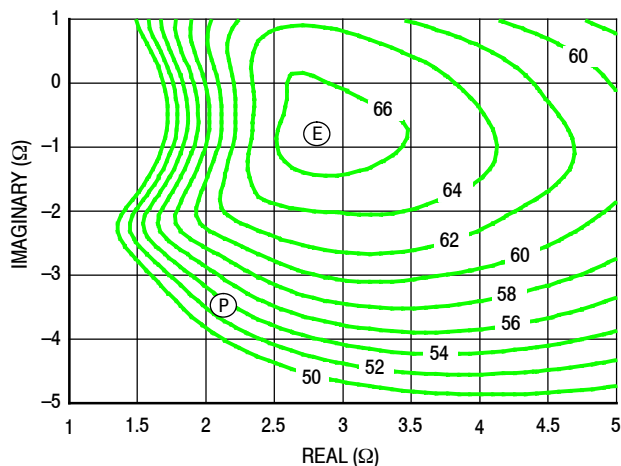

Figure 13. P3dB Load Pull Efficiency Contours (%)

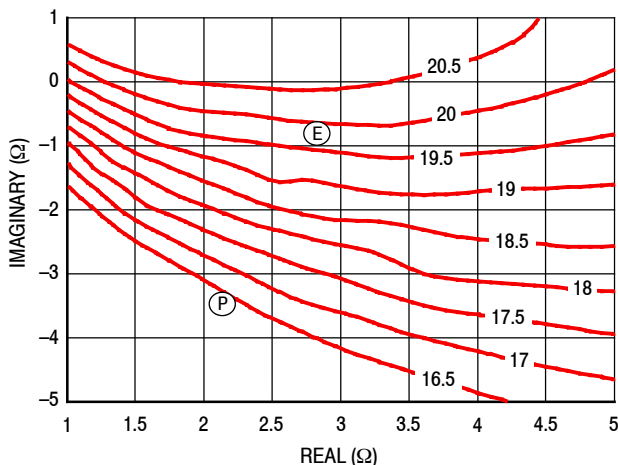

Figure 14. P3dB Load Pull Gain Contours (dB)

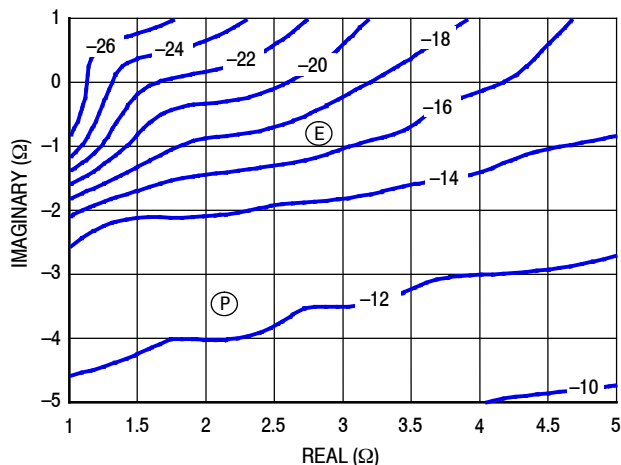
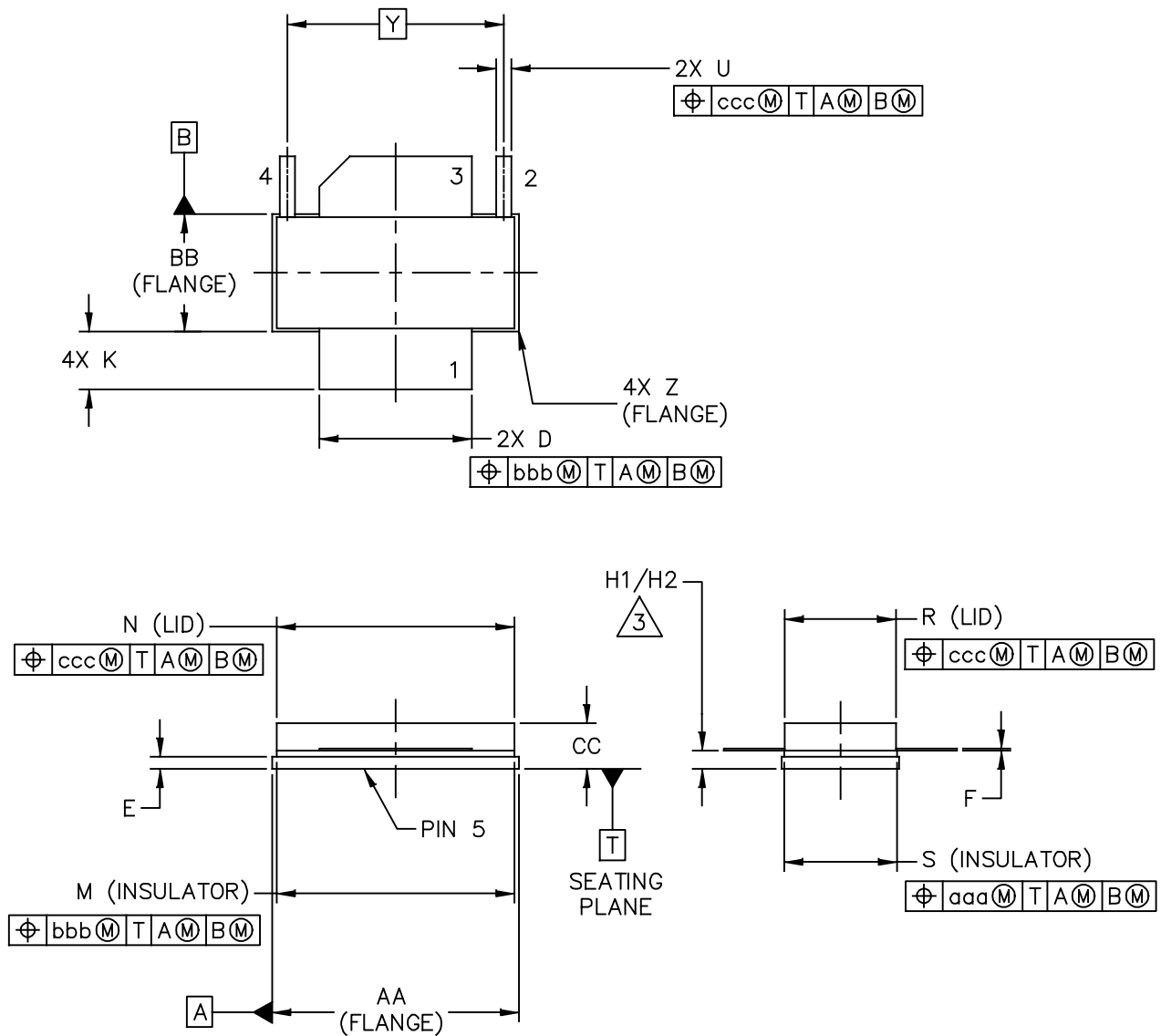

Figure 15. P3dB Load Pull AM/PM Contours (°)

NOTE: (P) = Maximum Output Power
(E) = Maximum Drain Efficiency

- Gain
- Drain Efficiency
- Linearity
- Output Power

PACKAGE DIMENSIONS



© FREESCALE SEMICONDUCTOR, INC. ALL RIGHTS RESERVED.	MECHANICAL OUTLINE	PRINT VERSION NOT TO SCALE
TITLE: NI-780S-2L2LA	DOCUMENT NO: 98ASA00658D	REV: 0
	STANDARD: NON-JEDEC	
	05 DEC 2014	

NOTES:

1. CONTROLLING DIMENSION: INCH.
2. INTERPRET DIMENSIONS AND TOLERANCES PER ASME Y14.5M-1994.

3. DIMENSIONS H1 AND H2 ARE MEASURED .030 INCH (0.762 MM) AWAY FROM THE FLANGE TO CLEAR THE EPOXY FLOW OUT REGION PARALLEL TO DATUM B. H1 APPLIES TO PINS 1 & 3. H2 APPLIES TO PINS 2 & 4.

DIM	INCH		MILLIMETER		DIM	INCH		MILLIMETER	
	MIN	MAX	MIN	MAX		MIN	MAX	MIN	MAX
AA	.805	.815	20.45	20.70	R	.365	.375	9.27	9.53
BB	.380	.390	9.65	9.91	S	.365	.375	9.27	9.53
CC	.125	.170	3.18	4.32	U	.045	.055	1.14	1.40
D	.495	.505	12.57	12.83	Y	.710 BSC		18.03 BSC	
E	.035	.045	0.89	1.14	Z	R.000	R.040	R0.00	R1.02
F	.003	.007	0.08	0.18	aaa	.005		0.13	
H1	.057	.067	1.45	1.70	bbb	.010		0.25	
H2	.054	.070	1.37	1.78	ccc	.015		0.38	
K	.170	.210	4.32	5.33					
M	.774	.786	19.66	19.96					
N	.772	.788	19.61	20.02					
© FREESCALE SEMICONDUCTOR, INC. ALL RIGHTS RESERVED.			MECHANICAL OUTLINE			PRINT VERSION NOT TO SCALE			
TITLE:					DOCUMENT NO: 98ASA00658D		REV: 0		
NI-780S-2L2LA					STANDARD: NON-JEDEC				
					05 DEC 2014				

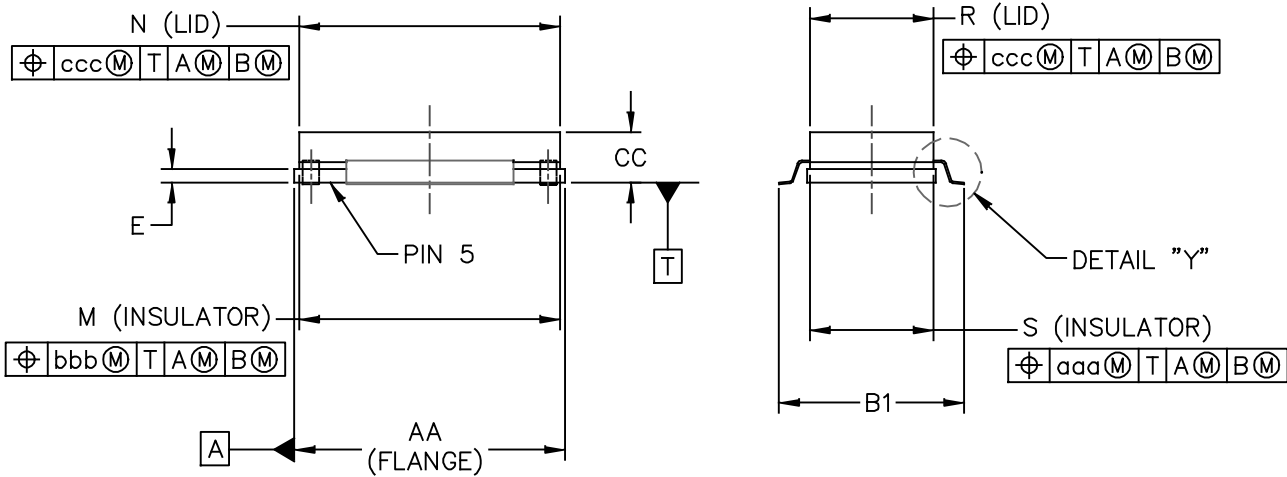
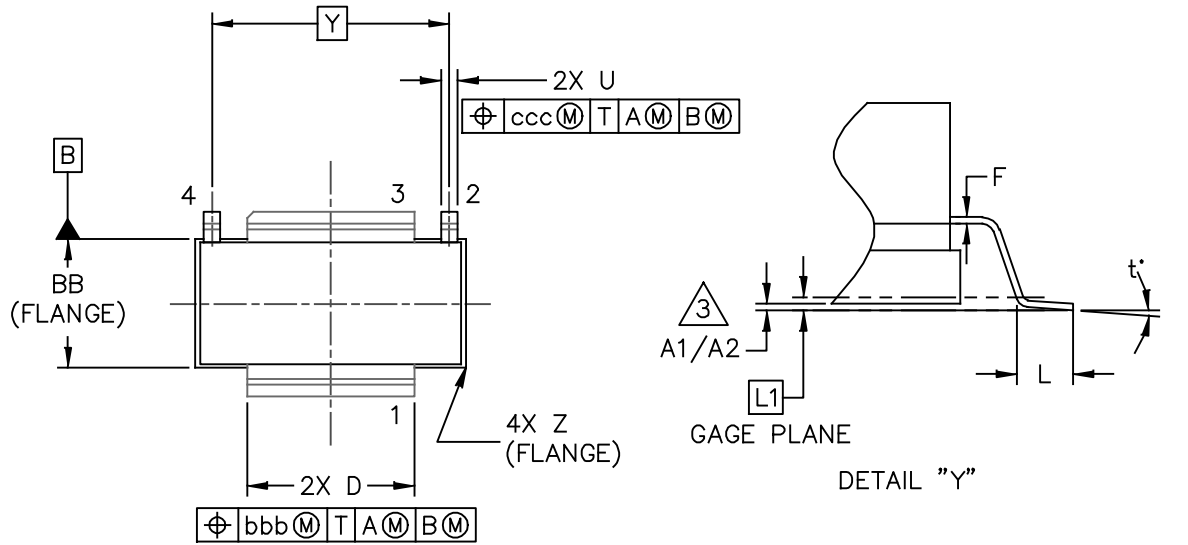

© FREESCALE SEMICONDUCTOR, INC. ALL RIGHTS RESERVED.	MECHANICAL OUTLINE	PRINT VERSION NOT TO SCALE
TITLE: NI-780GS-2L2LA	DOCUMENT NO: 98ASA00624D	REV: 0
	STANDARD: NON-JEDEC	
	05 DEC 2014	

NOTES:

1. CONTROLLING DIMENSION: INCH.
2. INTERPRET DIMENSIONS AND TOLERANCES PER ASME Y14.5M-1994.

3. DIMENSION A1/A2 IS MEASURED WITH REFERENCE TO DATUM T. THE POSITIVE VALUE IMPLIES THAT THE PACKAGE BOTTOM IS HIGHER THAN THE LEAD BOTTOM. A1 APPLIES TO PINS 1 AND 3. A2 APPLIES TO PINS 2 AND 4.

DIM	INCH		MILLIMETER		DIM	INCH		MILLIMETER	
	MIN	MAX	MIN	MAX		MIN	MAX	MIN	MAX
AA	.805	.815	20.45	20.70	R	.365	.375	9.27	9.53
A1	.002	.008	0.05	0.20	S	.365	.375	9.27	9.53
A2	.002	.008	0.05	0.20	U	.045	.055	1.14	1.40
BB	.380	.390	9.65	9.91	Y	.710 BSC		18.03 BSC	
B1	.546	.562	13.87	14.27	Z	R.000	R.040	R0.00	R1.02
CC	.125	.170	3.18	4.32	t*	0*	8*	0*	8*
D	.495	.505	12.57	12.83	aaa	.005		0.13	
E	.035	.045	0.89	1.14	bbb	.010		0.25	
F	.003	.007	0.08	0.18	ccc	.015		0.38	
L	.038	.046	0.97	1.17					
L1	.010 BSC		0.25 BSC						
M	.774	.786	19.66	19.96					
N	.772	.788	19.61	20.02					
© FREESCALE SEMICONDUCTOR, INC. ALL RIGHTS RESERVED.			MECHANICAL OUTLINE			PRINT VERSION NOT TO SCALE			
TITLE: NI-780GS-2L2LA					DOCUMENT NO: 98ASA00624D REV: 0				
					STANDARD: NON-JEDEC				
					05 DEC 2014				

PRODUCT DOCUMENTATION, SOFTWARE AND TOOLS

Refer to the following resources to aid your design process.

Application Notes

- AN1955: Thermal Measurement Methodology of RF Power Amplifiers

Engineering Bulletins

- EB212: Using Data Sheet Impedances for RF LDMOS Devices

Software

- Electromigration MTTF Calculator
- RF High Power Model
- s2p File

Development Tools

- Printed Circuit Boards

To Download Resources Specific to a Given Part Number:

1. Go to <http://www.freescale.com/rf>
2. Search by part number
3. Click part number link
4. Choose the desired resource from the drop down menu

REVISION HISTORY

The following table summarizes revisions to this document.

Revision	Date	Description
0	May 2015	• Initial Release of Data Sheet

How to Reach Us:

Home Page:
freescale.com

Web Support:
freescale.com/support

Information in this document is provided solely to enable system and software implementers to use Freescale products. There are no express or implied copyright licenses granted hereunder to design or fabricate any integrated circuits based on the information in this document.

Freescale reserves the right to make changes without further notice to any products herein. Freescale makes no warranty, representation, or guarantee regarding the suitability of its products for any particular purpose, nor does Freescale assume any liability arising out of the application or use of any product or circuit, and specifically disclaims any and all liability, including without limitation consequential or incidental damages. "Typical" parameters that may be provided in Freescale data sheets and/or specifications can and do vary in different applications, and actual performance may vary over time. All operating parameters, including "typicals," must be validated for each customer application by customer's technical experts. Freescale does not convey any license under its patent rights nor the rights of others. Freescale sells products pursuant to standard terms and conditions of sale, which can be found at the following address: freescale.com/SalesTermsandConditions.

Freescale and the Freescale logo are trademarks of Freescale Semiconductor, Inc., Reg. U.S. Pat. & Tm. Off. Airfast is a trademark of Freescale Semiconductor, Inc. All other product or service names are the property of their respective owners.

© 2015 Freescale Semiconductor, Inc.

Данный компонент на территории Российской Федерации

Вы можете приобрести в компании MosChip.

Для оперативного оформления запроса Вам необходимо перейти по данной ссылке:

<http://moschip.ru/get-element>

Вы можете разместить у нас заказ для любого Вашего проекта, будь то серийное производство или разработка единичного прибора.

В нашем ассортименте представлены ведущие мировые производители активных и пассивных электронных компонентов.

Нашей специализацией является поставка электронной компонентной базы двойного назначения, продукции таких производителей как XILINX, Intel (ex.ALTERA), Vicor, Microchip, Texas Instruments, Analog Devices, Mini-Circuits, Amphenol, Glenair.

Сотрудничество с глобальными дистрибьюторами электронных компонентов, предоставляет возможность заказывать и получать с международных складов практически любой перечень компонентов в оптимальные для Вас сроки.

На всех этапах разработки и производства наши партнеры могут получить квалифицированную поддержку опытных инженеров.

Система менеджмента качества компании отвечает требованиям в соответствии с ГОСТ Р ИСО 9001, ГОСТ РВ 0015-002 и ЭС РД 009

Офис по работе с юридическими лицами:

105318, г.Москва, ул.Щербаковская д.3, офис 1107, 1118, ДЦ «Щербаковский»

Телефон: +7 495 668-12-70 (многоканальный)

Факс: +7 495 668-12-70 (доб.304)

E-mail: info@moschip.ru

Skype отдела продаж:

moschip.ru

moschip.ru_4

moschip.ru_6

moschip.ru_9