

Camera & Software Vision Package

- Built-in high-quality image processing in a PC system
- Resolving a variety of applications with highly robust and advanced measurement algorithm
- Gigabit Ethernet camera that can be readily connected to the FJ application software (the connectivity tested and verified)
- Building an ideal machine vision using a customized sample in no time

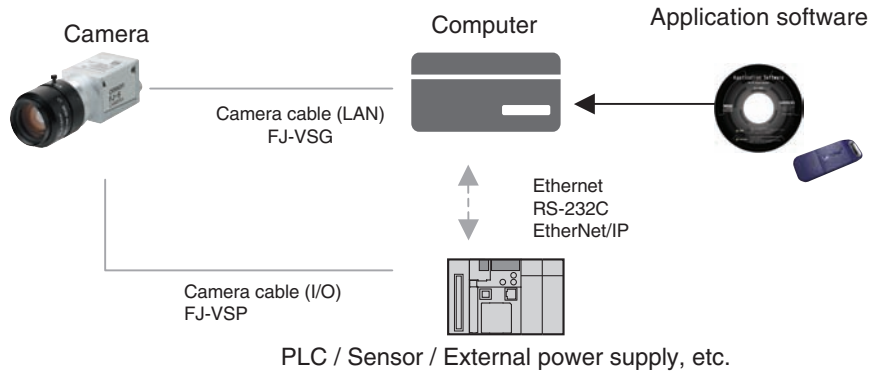

System Configuration



Ordering Information

Type		Model		Operating environment	
Camera & Software Vision Package • Application software × 1 license • Camera × 1 unit		300,000 pixels	Monochrome	FJ-SG-S	<ul style="list-style-type: none"> • CPU: Intel Pentium Processor (SSE2 or higher) • OS: Windows 7 Professional (32/64bit) or Enterprise (32/64bit) or Ultimate (32/64bit), Windows 8 Pro (32/64bit) or Enterprise (32/64bit), Windows 8.1 Pro (32/64bit) or Enterprise (32/64bit) • .NET Framework: .NET Framework 3.5 or higher • Memory: At least 2 GB RAM Available disk space: At least 2 GB • Camera interface: Ethernet 1000BASE-T • Display: XGA (1024 × 768), True Color (32-bit) or higher • Optical drive: CD/DVD drive
		300,000 pixels	Color	FJ-SCG-S	
		2 million pixels	Monochrome	FJ-S2MG-S	
		2 million pixels	Color	FJ-SC2MG-S	
		5 million pixels	Monochrome	FJ-S5MG-S	
		5 million pixels	Color	FJ-SC5MG-S	
Camera (Single unit)		300,000 pixels	Monochrome	FJ-SG	-
		300,000 pixels	Color	FJ-SCG	
		2 million pixels	Monochrome	FJ-S2MG	
		2 million pixels	Color	FJ-SC2MG	
		5 million pixels	Monochrome	FJ-S5MG	
		5 million pixels	Color	FJ-SC5MG	
Camera cable (LAN)		Cable length: 3 m, 5 m, 10 m, 20 m, 40 m		FJ-VSG □ m *2	
Camera cable (Power, I/O)		Cable length: 3 m, 5 m, 10 m *1		FJ-VSP □ m *2	
Development environment Application Producer	Media only	CD-ROM		FH-AP1	<ul style="list-style-type: none"> • CPU: Intel Pentium Processor (SSE2 or higher) • OS: Windows 7 Professional (32/64bit) or Enterprise (32/64bit) or Ultimate (32/64bit), Windows 8 Pro (32/64bit) or Enterprise (32/64bit), Windows 8.1 Pro (32/64bit) or Enterprise (32/64bit) • .NET Framework: .NET Framework 3.5 or higher • Memory: At least 2 GB RAM Available disk space: At least 2 GB • Browser: Microsoft® Internet Explorer 6.0 or later • Display: XGA (1024 × 768), True Color (32-bit) or higher • Optical drive: CD/DVD drive • The following operating environment is required to use the camera FJ-S□□□G. Camera interface: Ethernet 1000BASE-T • The following software is required to customize the software: Microsoft® Visual Studio® 2010 Professional, or Microsoft® Visual Studio® 2008 Professional, or Microsoft® Visual Studio® 2012 Professional
	1 license	-		FH-AP1L	

*1. 10-m cable can be used with 300,000-pixel cameras FJ-SCG/SG and 2-million pixel cameras FJ-SC2MG/S2MG.

*2. The boxes in the model numbers are replaced by the cable length: 3 m = 3, 5 m = 5, 10 m = 10, 20 m = 20 and 40 m = 40

Lenses

High-resolution, Low-distortion Lenses

Model	3Z4S-LE SV-0614H	3Z4S-LE SV-0814H	3Z4S-LE SV-1214H	3Z4S-LE SV-1614H	3Z4S-LE SV-2514H	3Z4S-LE SV-3514H	3Z4S-LE SV-5014H	3Z4S-LE SV-7525H	3Z4S-LE SV-10028H
Appearance/Dimensions (mm)									
Focal length	6mm	8mm	12mm	16mm	25mm	35mm	50mm	75mm	100mm
Brightness	F1.4	F1.4	F1.4	F1.4	F1.4	F1.4	F1.4	F2.5	F2.8
Filter size	M40.5 P0.5	M35.5 P0.5	M27 P0.5	M27 P0.5	M27 P0.5	M35.5 P0.5	M40.5 P0.5	M34.0 P0.5	M37.5 P0.5

CCTV Lenses

Model	3Z4S-LE SV-03514V	3Z4S-LE SV-04514V	3Z4S-LE SV-0614V	3Z4S-LE SV-0813V	3Z4S-LE SV-1214V	3Z4S-LE SV-1614V	3Z4S-LE SV-2514V	3Z4S-LE SV-3518V	3Z4S-LE SV-5018V	3Z4S-LE SV-7527V	3Z4S-LE SV-10035V
Appearance/Dimensions (mm)											
Focal length	3.5mm	4.5mm	6mm	8mm	12mm	16mm	25mm	35mm	50mm	75mm	100mm
Brightness	F1.4	F1.4	F1.4	F1.3	F1.4	F1.4	F1.4	F1.8	F1.8	F2.7	F3.5
Filter size	—	—	M27 P0.5	M25.5 P0.5	M27 P0.5	M27 P0.5	M27 P0.5	M27 P0.5	M30.5 P0.5	M30.5 P0.5	M30.5 P0.5

Extension Tubes

Model	3Z4S-LE SV-EXR
Contents	Set of 7 tubes(40 mm, 20 mm, 10 mm, 5 mm, 2.0 mm, 1.0 mm, and 0.5 mm) Maximum outer diameter: 30 mm dia.

- Do not use the 0.5-mm, 1.0-mm, and 2.0-mm Extension Tubes attached to each other. Since these Extension Tubes are placed over the threaded section of the Lens or other Extension Tube, the connection may loosen when more than one 0.5-mm, 1.0-mm or 2.0-mm Extension Tube are used together.
- Reinforcement is required to protect against vibration when Extension Tubes exceeding 30 mm are used.



























Ratings and Performance

	FJ-SCG/SG	FJ-SC2MG/S2MG	FJ-SC5MG/S5MG
Imaging element	Progressive scan 1/3-inch CCD	Progressive scan 1/1.8-inch CCD	Progressive scan 2/3-inch CCD
Effective pixels	656 (H) × 492 (V): Color	1616 (H) × 1234 (V): Color	2448 (H) × 2056 (V): Color
	656 (H) × 494 (V): Monochrome	1616 (H) × 1236 (V): Monochrome	2448 (H) × 2058 (V): Monochrome
Pixel size	7.4 (μm) × 7.4 (μm)	4.4 (μm) × 4.4 (μm)	3.45 (μm) × 3.45 (μm)
Synchronous system	Internal synchronous		
Frame rate	90fps	20fps	17fps
Number of uptake lines	Min 2 line to Effective pixels (V) (2 lines interval)		
Gain	0dB to +25dB	0dB to +18dB	0dB to +14dB
Shutter speed	17 μs to 1 s	25 μs to 1 s	29 μs to 10 s
Video output	Digital 8 bit		
Trigger input	External trigger / Software trigger (Ethernet)		
External output	Strobe trigger / Trigger READY		
I/F	Gigabit Ethernet (1 Gbit/s)		
Lens mount	C mount		
Power voltage	PoE/12VDC±10%		11.3 to 13.2VDC
Pick-up voltage when camera cable FJ-VSP is used	3 m	11.3 to 13.2VDC	11.8 to 13.8VDC
	5 m		
	10 m		Cannot be used.
Power consumption	PoE supply: 3.6 W	PoE supply: 3.8 W	Power and I/O connector supply: 6.4 W
	Power and I/O connector supply: 3.1 W	Power and I/O connector supply: 3.2 W	
Vibration resistance	10 to 150 Hz, Half amplitude 0.35 mm (Acceleration: Max. 50 m/s ²), 3 directions (X/Y/Z) 8 minutes each, 10 times		
Impact resistance	150 m/s ² , 6 directions (Up and Down, Right and Left, Back and Forth) 3 times each		
Ambient temperature	In operation: 0 to 40°C (Chassis surface temperature should be 55°C or lower.)		
	In storage: -25 to +65°C (no freezing or condensation)		
Ambient humidity	In operation and storage: 35 to 85% RH each (no condensation)		
Ambient environment	No corrosive gas		
Protective structure	IEC60529 standard IP30		
Weight	Approx. 90 g		Approx. 220 g

Processing Items

Group	Icon	Processing Item	
Measurement		Search	Used to identify the shapes and calculate the position of measurement objects.
		Flexible Search	Recognizing the shapes of workpieces with variation and detecting their positions.
		Sensitive Search	Search a small difference by dividing the search model in detail, and calculating the correlation.
		ECM Search	Used to search the similar part of model from input image. Detect the evaluation value and position.
		EC Circle Search	Extract circles using "round" shape information and get position, radius and quantity in high preciseness.
		Shape Search II	Used to search the similar part of model from input image regardless of environmental changes. Detect the evaluation value and position.
		Shape Search III	Robust detection of positions is possible at high-speed and with high precision incorporating environmental fluctuations, such as differences in individual shapes of the workpieces, pose fluctuations, noise superimposition and shielding.
		EC Corner	This processing item measures a corner position (corner) of a workpiece.
		EC Cross	The center position of a crosshair shape is measured using the lines created by the edge information on each side of the crosshair.
		Classification	Used when various kinds of products on the assembly line need to be sorted and identified.
		Edge Position	Measure position of measurement objects according to the color change in measurement area.
		Edge Pitch	Detect edges by color change in measurement area. Used for calculating number of pins of IC and connectors.
		Scan Edge Position	Measure peak/bottom edge position of workpieces according to the color change in separated measurement area.
		Scan Edge Width	Measure max/min/average width of workpieces according to the color change in separated measurement area.
		Circular Scan Edge Position	Measure center axis, diameter and radius of circular workpieces.
		Circular Scan Edge Width	Measure center axis, width and thickness of ring workpieces.
		Intersection	Calculate approximate lines from the edge information on two sides of a square workpiece to measure the angle formed at the intersection of the two lines.
		Color Data	Used for detecting presence and mixed varieties of products by using color average and deviation.
		Gravity and Area	Used to measure area, center of gravity of workpieces by extracting the color to be measured.
		Labeling	Used to measure number, area and gravity of workpieces by extracting registered color.
		Label Data	Selecting one region of extracted Labeling, and get that measurement. Area and Gravity position can be got and judged.
		Defect	Used for appearance measurement of plain-color measurement objects such as defects, stains and burrs.
		Precise Defect	Check the defect on the object. Parameters for extraction defect can be set precisely.
		Fine Matching	Difference can be detected by overlapping and comparing (matching) registered fine images with input images.
		Character Inspect	Recognize character according correlation search with model image registered in [Model Dictionary].
		Date Verification	Reading character string is verified with internal date.
		Model Dictionary	Register character pattern as dictionary. The pattern is used in [Character Inspection].
		2DCode *2	Recognize 2D code and display where the code quality is poor.
		Barcode *1	Recognize barcode, verify and output decoded characters.
		OCR	Recognize and read characters in images as character information.
		OCR User Dictionary	Register dictionary data to use for OCR.
		Circle Angle	Used for calculating angle of inclination of circular measurement objects.
		Glue Bead Inspection	You can inspect coating of a specified color for gaps or runoffs along the coating path.
	Input Image		Camera image input GigE
		Camera Image Input HDR	Create high-dynamic range images by acquiring several images with different conditions.
		Camera Switch	To switch the cameras used for measurement. Not input images from cameras again.
		Measurement Image Switching	To switch the images used for measurement. Not input images from camera again.

Group	Icon	Processing Item		
Compensate image		Position Compensation	Used when positions are differed. Correct measurement is performed by correcting position of input images.	
		Filtering	Used for processing images input from cameras in order to make them easier to be measured.	
		Background Suppression	To enhance contrast of images by extracting color in specified brightness.	
		Brightness Correct Filter	Track brightness change of entire screen and remove gradual brightness change such as uneven brightness.	
		Color Gray Filter	Color image is converted into monochrome images to emphasize specific color.	
		Extract Color Filter	Convert color image to color extracted image or binary image.	
		Anti Color Shading	To remove the irregular color/pattern by uniformizing max.2 specified colors.	
		Stripes Removal Filter II	Remove the background pattern of vertical, horizontal and diagonal stripes.	
		Polar Transformation	Rectify the image by polar transformation. Useful for OCR or pattern inspection printed on circle.	
		Trapezoidal Correction	Rectify the trapezoidal deformed image.	
		Machine Simulator	How the alignment marks would move on the image when each stage or robot axis is controlled can be checked.	
		Image Subtraction	The registered model image and measurement image are compared and only the different pixels are extracted and converted to an image.	
		Advanced filter	Process the images acquired from cameras in order to make them easier to measure. This processing item consolidates existing image conversion filtering into one processing item and adds extra functions.	
		Panorama	Combine multiple image to create one big image.	
	Support measurement		Unit Macro	Advanced arithmetic processing can be easily incorporated into workflow as Unit Macro processing items.
			Unit Calculation Macro	This function is convenient when the user wants to calculate a value using an original calculation formula or change the set value or system data of a processing item.
			Calculation	Used when using the judge results and measured values of Procltem which are registered in processing units.
		Line Regression	Used for calculating regression line from plural measurement coordinate.	
		Circle Regression	Used for calculating regression circle from plural measurement coordinate.	
		Precise Calibration	Used for calibration corresponding to trapezoidal distortion and lens distortion.	
		User Data	Used for setting of the data that can be used as common constants and variables in scene group data.	
		Set Unit Data	Used to change the Procltem data (setting parameters, etc.) that has been set up in a scene.	
		Get Unit Data	Used to get one data (measured results, setting parameters, etc.) of Procltem that has been set up in a scene.	
		Set Unit Figure	Used for re-setting the figure data (model, measurement area) registered in an unit.	
		Get Unit Figure	Used for get the figure data (model, measurement area) registered in an unit.	
		Trend Monitor	Used for displaying the information about results on the monitor, facilitating to avoid NG and analyze causes.	
		Image Logging	Used for saving the measurement images to the memory and USB memory.	
		Image Conversion Logging	Used for saving the measurement images in JPEG and BMP format.	
		Data Logging	Used for saving the measurement data to the memory and USB memory.	
		Elapsed Time	Used for calculating the elapsed time since the measurement trigger input.	
		Wait	Processing is stopped only at the set time. The standby time is set by the unit of [ms].	
	Focus	Focus setting is supported.		
	Iris	Focus and aperture setting is supported.		
	Parallelize	A part of the measurement flow is divided into two or more tasks and processed in parallel to shorten the measurement time. This processing item is placed at the top of processing to be performed in parallel.		
	Parallelize Task	A part of the measurement flow is divided into two or more tasks and processed in parallel to shorten the measurement time. This processing item is placed immediately before processing to be performed in parallel between Parallelize and Parallelize End.		
	Statistics	Used when you need to calculate an average of multiple measurement results.		

Group	Icon	Processing Item	
Support measurement		Reference Calib Data	Calibration data and distortion compensation data held under other processing items can be referenced.
		Position Data Calculation	The specified position angle is calculated from the measured positions.
		Stage Data	Sets and stores data related to stages.
		Robot Data	Sets and stores data related to robots.
		Vision Master Calibration	This processing item automatically calculates the entire axis movement amount of the control equipment necessary for calibration.
		PLC Masteoer Calibration	Calibration data is created using a communication command from PLC.
		Convert Position Data	The position angle after the specified axis movement is calculated.
		Movement Single Position	The axis movement that is required to match the measured position angle to the reference position angle is calculated.
		Movement Multi Points	The axis movements that are required to match the measured position angles to the corresponding reference position angles are calculated.
		Detection Point	Obtains position/angle information by referring to the coordinate values measured with the Measurement Processing Unit.
		Camera Calibration	By setting the camera calibration, the measurement result can be converted and output as actual dimensions.
		Data Save	The set data can be saved in the controller main unit or as scene data. The data is held even after the FH/FZ power is turned off.
Branch		Conditional Branch	Used where more than two kinds of products on the production line need to detected separately.
		End	This Procltem must be set up as the last processing unit of a branch.
		DI Branch	Same as Procltem "Branch". But you can change the targets of conditional branching via external inputs.
		Control Flow Normal	Set the measurement flow processing into the wait state in which the specific no-protocol command can be executed.
		Control Flow PLC Link	Set the measurement flow processing into the wait state in which the specific PLC Link command can be executed.
		Control Flow Parallel	Set the measurement flow processing into the wait state in which the specific parallel command can be executed.
		Control Flow Fieldbus	Set the measurement flow processing into the wait state in which the specific Fieldbus command can be executed.
		Selective Branch	Easily branch to multiple destinations.
Output results		Data Output	Used when you need to output data to the external devices such as PLC or PC via serial ports.
		Parallel Data Output	Used when you need to output data to the external devices such as PLC or PC via parallel ports.
		Parallel Judgement Output	Used when you need to output judgement results to the external devices such as PLC or PC via parallel ports.
		Fieldbus Data Output	Outputs data to an external device, such as a Programmable Controller, through a fieldbus interface.
Output result		Result Display	Used for displaying the texts or the figures in the camera image.
		Display Image File	Display selected image file.
		Display Last NG Image	Display the last NG images.

*1 Bar Codes that can be read : JAN/EAN/UPC (including add-on codes), Code 39, Codabar (NW-7), ITF (Interleaved 2 of 5), Code 93, Code 128, GS1-128, GS1 DataBar (RSS-14 / RSS Limited / RSS Expanded), Pharmacode

*2 2D Codes that can be read : Data Matrix (ECC200), QR Code

External Dimensions

FJ-SCG/SG/SC2MG/S2MG

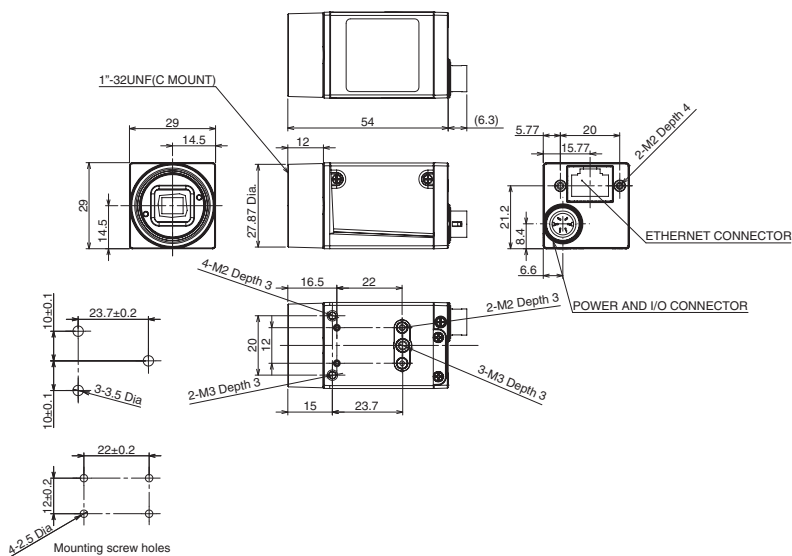

FJ-SC5MG/S5MG

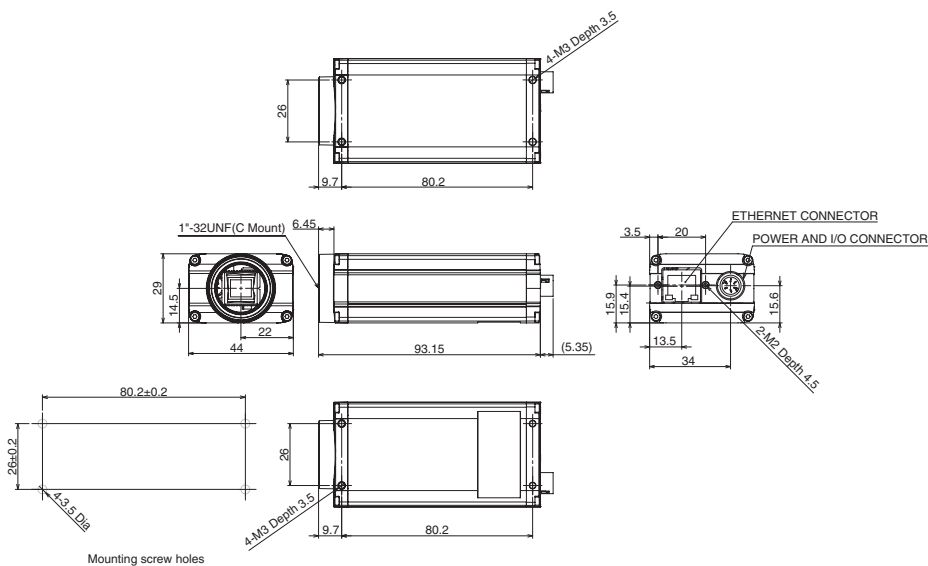

Optical Chart

5 million-pixel digital camera FJ-SC5MG/S5MG

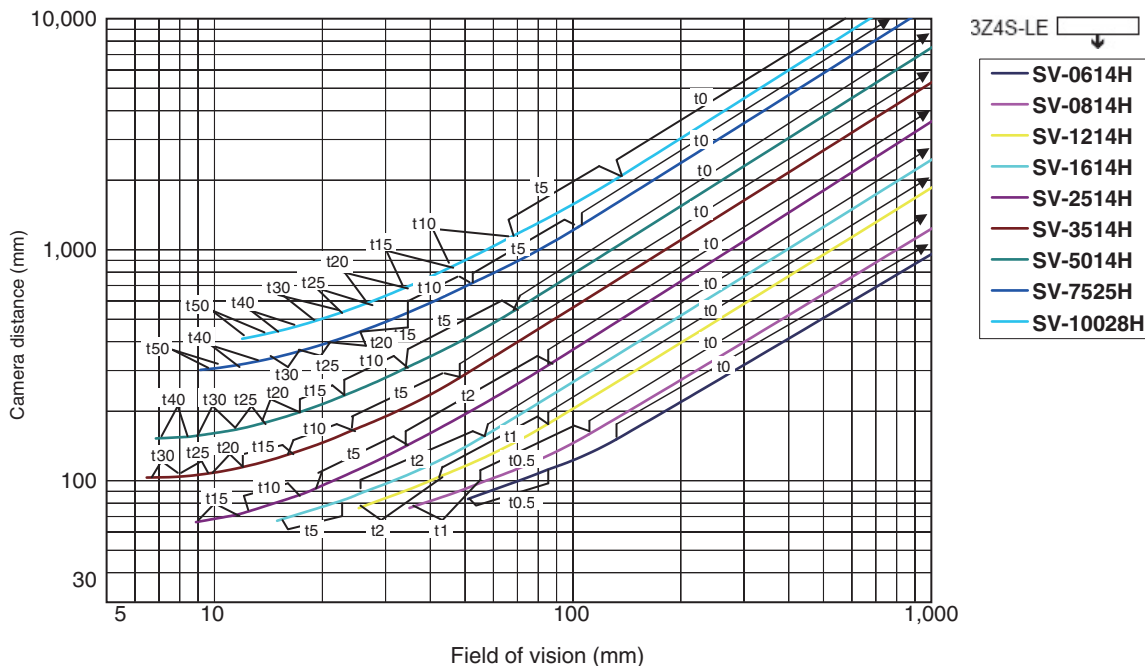

2 million-pixel digital camera FJ-SC2MG/S2MG

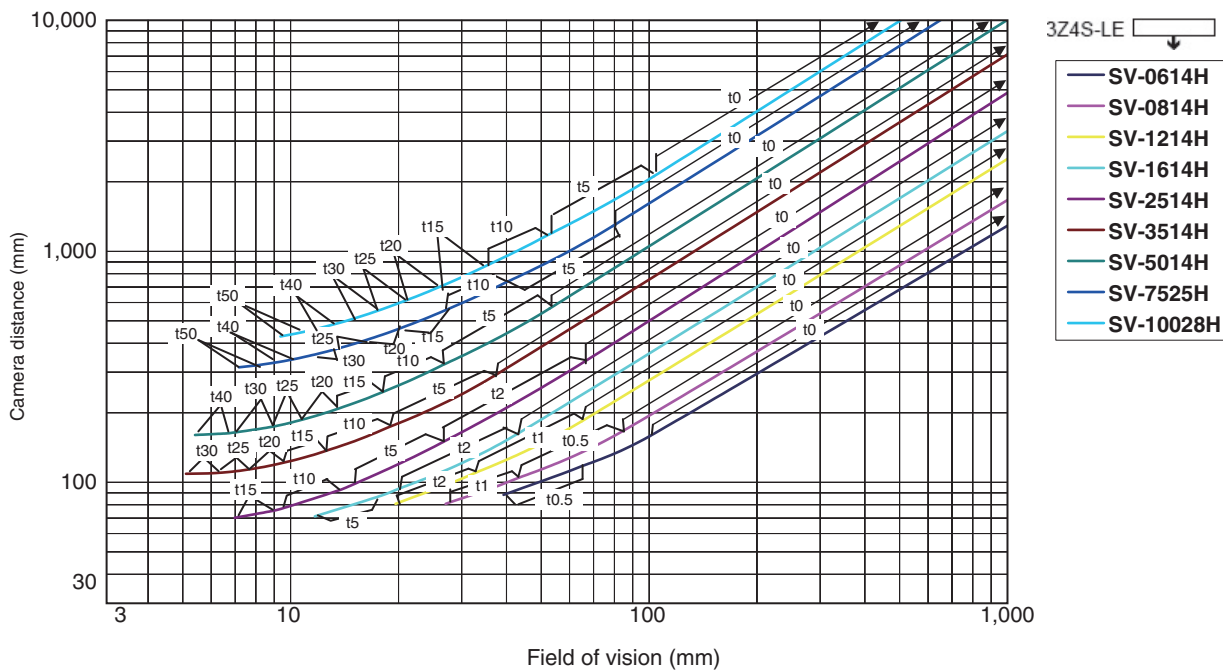

300,000-pixel digital camera FJ-SCG/SG

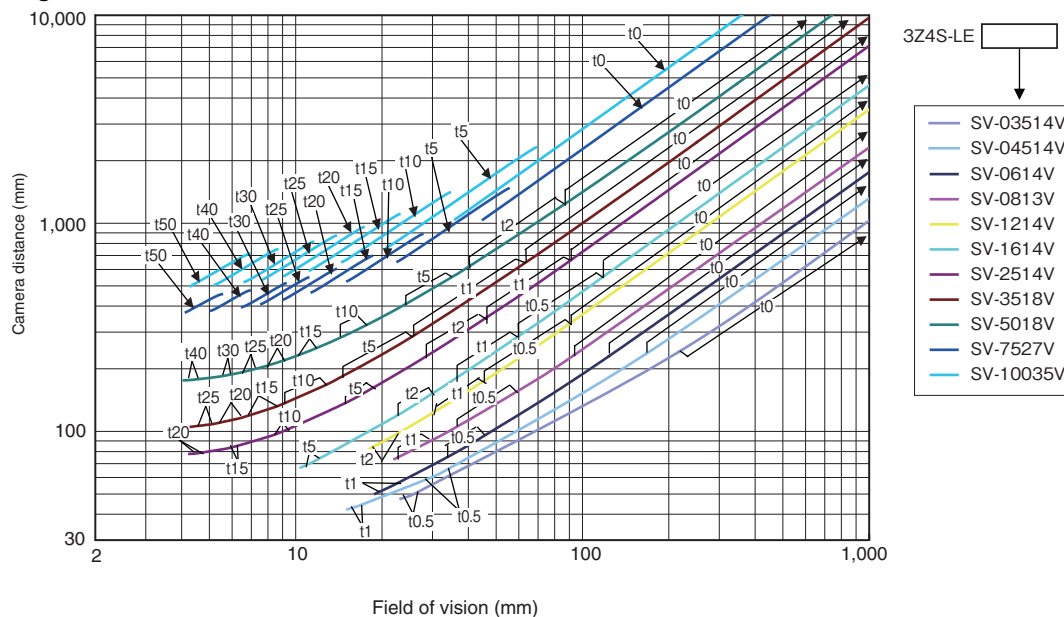

■ Meaning of Optical Chart

The X axis of the optical chart shows the field of vision (mm)(Note1), and the Y axis of the optical chart shows the camera installation distance (mm)(Note2).

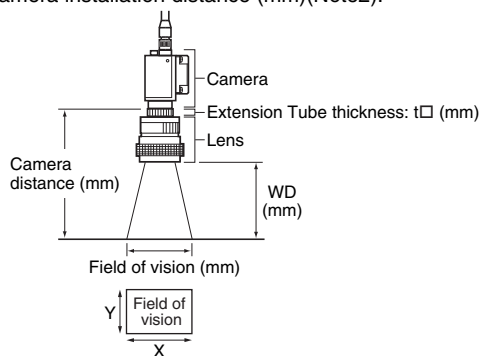

- Note: 1. The lengths of the fields of vision given in the optical charts are the lengths of the Y axis.
- 2. The vertical axis represents WD for small cameras.

READ AND UNDERSTAND THIS DOCUMENT

Please read and understand this document before using the products. Please consult your OMRON representative if you have any questions or comments.

WARRANTY

OMRON's exclusive warranty is that the products are free from defects in materials and workmanship for a period of one year (or other period if specified) from date of sale by OMRON.

OMRON MAKES NO WARRANTY OR REPRESENTATION, EXPRESS OR IMPLIED, REGARDING NON-INFRINGEMENT, MERCHANTABILITY, OR FITNESS FOR PARTICULAR PURPOSE OF THE PRODUCTS. ANY BUYER OR USER ACKNOWLEDGES THAT THE BUYER OR USER ALONE HAS DETERMINED THAT THE PRODUCTS WILL SUITABLY MEET THE REQUIREMENTS OF THEIR INTENDED USE. OMRON DISCLAIMS ALL OTHER WARRANTIES, EXPRESS OR IMPLIED.

LIMITATIONS OF LIABILITY

OMRON SHALL NOT BE RESPONSIBLE FOR SPECIAL, INDIRECT, OR CONSEQUENTIAL DAMAGES, LOSS OF PROFITS OR COMMERCIAL LOSS IN ANY WAY CONNECTED WITH THE PRODUCTS, WHETHER SUCH CLAIM IS BASED ON CONTRACT, WARRANTY, NEGLIGENCE, OR STRICT LIABILITY.

In no event shall responsibility of OMRON for any act exceed the individual price of the product on which liability is asserted.

IN NO EVENT SHALL OMRON BE RESPONSIBLE FOR WARRANTY, REPAIR, OR OTHER CLAIMS REGARDING THE PRODUCTS UNLESS OMRON'S ANALYSIS CONFIRMS THAT THE PRODUCTS WERE PROPERLY HANDLED, STORED, INSTALLED, AND MAINTAINED AND NOT SUBJECT TO CONTAMINATION, ABUSE, MISUSE, OR INAPPROPRIATE MODIFICATION OR REPAIR.

SUITABILITY FOR USE

THE PRODUCTS CONTAINED IN THIS DOCUMENT ARE NOT SAFETY RATED. THEY ARE NOT DESIGNED OR RATED FOR ENSURING SAFETY OF PERSONS, AND SHOULD NOT BE RELIED UPON AS A SAFETY COMPONENT OR PROTECTIVE DEVICE FOR SUCH PURPOSES. Please refer to separate catalogs for OMRON's safety rated products.

OMRON shall not be responsible for conformity with any standards, codes, or regulations that apply to the combination of products in the customer's application or use of the product.

At the customer's request, OMRON will provide applicable third party certification documents identifying ratings and limitations of use that apply to the products. This information by itself is not sufficient for a complete determination of the suitability of the products in combination with the end product, machine, system, or other application or use.

The following are some examples of applications for which particular attention must be given. This is not intended to be an exhaustive list of all possible uses of the products, nor is it intended to imply that the uses listed may be suitable for the products:

- Outdoor use, uses involving potential chemical contamination or electrical interference, or conditions or uses not described in this document.
- Nuclear energy control systems, combustion systems, railroad systems, aviation systems, medical equipment, amusement machines, vehicles, safety equipment, and installations subject to separate industry or government regulations.
- Systems, machines, and equipment that could present a risk to life or property.

Please know and observe all prohibitions of use applicable to the products.

NEVER USE THE PRODUCTS FOR AN APPLICATION INVOLVING SERIOUS RISK TO LIFE OR PROPERTY WITHOUT ENSURING THAT THE SYSTEM AS A WHOLE HAS BEEN DESIGNED TO ADDRESS THE RISKS, AND THAT THE OMRON PRODUCT IS PROPERLY RATED AND INSTALLED FOR THE INTENDED USE WITHIN THE OVERALL EQUIPMENT OR SYSTEM.

PERFORMANCE DATA

Performance data given in this document is provided as a guide for the user in determining suitability and does not constitute a warranty. It may represent the result of OMRON's test conditions, and the users must correlate it to actual application requirements. Actual performance is subject to the OMRON Warranty and Limitations of Liability.

CHANGE IN SPECIFICATIONS

Product specifications and accessories may be changed at any time based on improvements and other reasons.

It is our practice to change model numbers when published ratings or features are changed, or when significant construction changes are made. However, some specifications of the product may be changed without any notice. When in doubt, special model numbers may be assigned to fix or establish key specifications for your application on your request. Please consult with your OMRON representative at any time to confirm actual specifications of purchased products.

DIMENSIONS AND WEIGHTS

Dimensions and weights are nominal and are not to be used for manufacturing purposes, even when tolerances are shown.

ERRORS AND OMISSIONS

The information in this document has been carefully checked and is believed to be accurate; however, no responsibility is assumed for clerical, typographical, or proofreading errors, or omissions.

PROGRAMMABLE PRODUCTS

OMRON shall not be responsible for the user's programming of a programmable product, or any consequence thereof.

COPYRIGHT AND COPY PERMISSION

This document shall not be copied for sales or promotions without permission.

This document is protected by copyright and is intended solely for use in conjunction with the product. Please notify us before copying or reproducing this document in any manner, for any other purpose. If copying or transmitting this document to another, please copy or transmit it in its entirety.

Note: Do not use this document to operate the Unit.

OMRON Corporation Industrial Automation Company
Tokyo, JAPAN

Contact: www.ia.omron.com

Regional Headquarters

OMRON EUROPE B.V.

Sensor Business Unit

Carl-Benz-Str. 4, D-71154 Nufringen, Germany
Tel: (49) 7032-811-0/Fax: (49) 7032-811-199

OMRON ELECTRONICS LLC

One Commerce Drive Schaumburg,
IL 60173-5302 U.S.A.

Tel: (1) 847-843-7900/Fax: (1) 847-843-7787

OMRON ASIA PACIFIC PTE. LTD.

No. 438A Alexandra Road # 05-05/08 (Lobby 2),
Alexandra Technopark,
Singapore 119967
Tel: (65) 6835-3011/Fax: (65) 6835-2711

OMRON (CHINA) CO., LTD.

Room 2211, Bank of China Tower,
200 Yin Cheng Zhong Road,
PuDong New Area, Shanghai, 200120, China
Tel: (86) 21-5037-2222/Fax: (86) 21-5037-2200

Authorized Distributor:

© OMRON Corporation 2011 All Rights Reserved.
In the interest of product improvement,
specifications are subject to change without notice.

CSM_3_3_1215

Cat. No. Q188-E1-01

0811(0811)

Mouser Electronics

Authorized Distributor

Click to View Pricing, Inventory, Delivery & Lifecycle Information:

Omron:

[FJ-VSG 5M](#) [FJ-VSP 3M](#) [FJ-VSP 10M](#) [FJ-VSG 20M](#) [FJ-VSG 10M](#) [FJ-VSG 40M](#) [FJ-VSG 3M](#) [FJ-VSP 5M](#)

Данный компонент на территории Российской Федерации

Вы можете приобрести в компании MosChip.

Для оперативного оформления запроса Вам необходимо перейти по данной ссылке:

<http://moschip.ru/get-element>

Вы можете разместить у нас заказ для любого Вашего проекта, будь то серийное производство или разработка единичного прибора.

В нашем ассортименте представлены ведущие мировые производители активных и пассивных электронных компонентов.

Нашей специализацией является поставка электронной компонентной базы двойного назначения, продукции таких производителей как XILINX, Intel (ex.ALTERA), Vicor, Microchip, Texas Instruments, Analog Devices, Mini-Circuits, Amphenol, Glenair.

Сотрудничество с глобальными дистрибьюторами электронных компонентов, предоставляет возможность заказывать и получать с международных складов практически любой перечень компонентов в оптимальные для Вас сроки.

На всех этапах разработки и производства наши партнеры могут получить квалифицированную поддержку опытных инженеров.

Система менеджмента качества компании отвечает требованиям в соответствии с ГОСТ Р ИСО 9001, ГОСТ РВ 0015-002 и ЭС РД 009

Офис по работе с юридическими лицами:

105318, г.Москва, ул.Щербаковская д.3, офис 1107, 1118, ДЦ «Щербаковский»

Телефон: +7 495 668-12-70 (многоканальный)

Факс: +7 495 668-12-70 (доб.304)

E-mail: info@moschip.ru

Skype отдела продаж:

moschip.ru

moschip.ru_4

moschip.ru_6

moschip.ru_9