

GaAs pHEMT MMIC MEDIUM POWER AMPLIFIER, 5.5 - 18 GHz

Typical Applications

The HMC1082LP4E is ideal for:

- Point-to-Point Radios
- Point-to-Multi-Point Radios
- VSAT & SATCOM
- Marine Radar
- Military EW & ECM

Features

- High Saturated Output Power: 26 dBm @ 26% PAE
- High Output IP3: 35 dBm
- High Gain: 22 dB
- High P1dB Output Power: 24 dBm
- DC Supply: +5V @ 220 mA
- Compact 24 Lead 4x4 mm SMT Package: 16 mm²

Functional Diagram

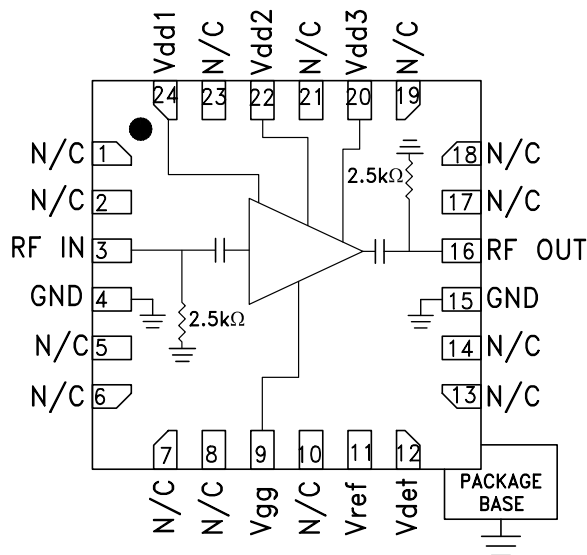

General Description

The HMC1082LP4E is a GaAs pHEMT MMIC driver amplifier with an integrated temperature compensated on-chip power detector which operates between 5.5 and 18 GHz. The amplifier provides 22 dB of gain, +35 dBm Output IP3, and +24 dBm of output power at 1 dB gain compression, while requiring 220 mA from a +5V supply. The HMC1082LP4E is capable of supplying +26 dBm of saturated output power with 26 % PAE and is housed in a compact leadless 4x4 mm plastic surface mount package.

The HMC1082LP4E is an ideal driver amplifier for a wide range of applications including point-to-point radio from 5.5 to 18 GHz and marine radar at 9 GHz. The HMC1082LP4E may also be used for 6 to 18 GHz EW and ECM applications.

Electrical Specifications

$T_A = +25^\circ\text{C}$, $V_{dd1} = V_{dd2} = V_{dd3} = +5\text{V}$, $I_{dd} = +220\text{mA}$ [1]

Parameter	Min	Typ.	Max	Min	Typ.	Max	Min	Typ	Max	Units
Frequency Range		5.5 - 6.5		6.5 - 17			17 - 18			GHz
Gain	21.5	23.5		20.5	22.5		20	22		dB
Gain Variation over temperature		0.0121			0.0101			0.015		dB/°C
Input Return Loss		22			12			7.5		dBm
Output Return Loss		10			14			17.5		dBm
Output Power for 1 dB Compression (P1dB)	21	24		21	24		20.5	23.5		dBm
Saturated Output Power (Psat)		25.5			26			24.5		dBm
Output Third Order Intercept (IP3) [2]		36			35			33.5		dBm
Supply Current (Idd)		220			220			220		mA

[1] Adjust Vgg between -2 to 0V to achieve Idd = 220mA typical

[2] Measurement taken at Pout / tone = +12dBm

**GaAs pHEMT MMIC MEDIUM
POWER AMPLIFIER, 5.5 - 18 GHz**

Broadband Gain & Return Loss

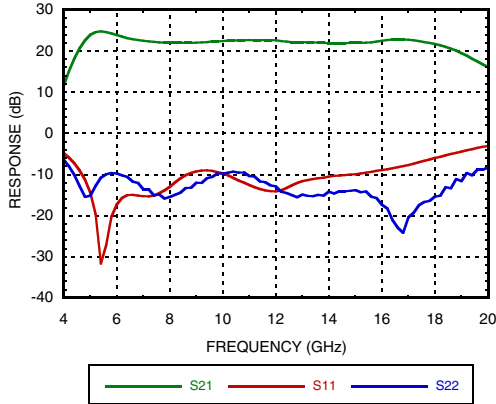

Gain vs. Temperature

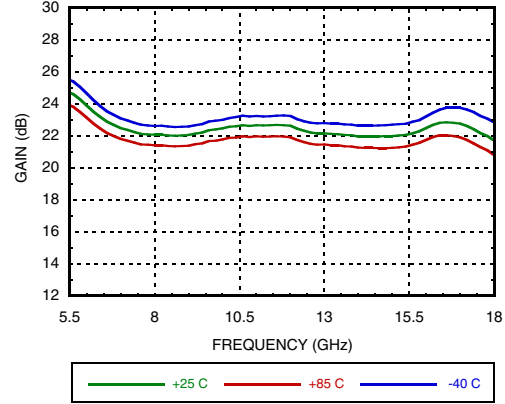

Input Return Loss vs. Temperature

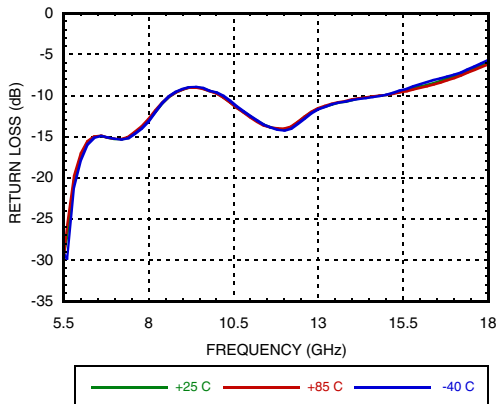

Output Return Loss vs. Temperature

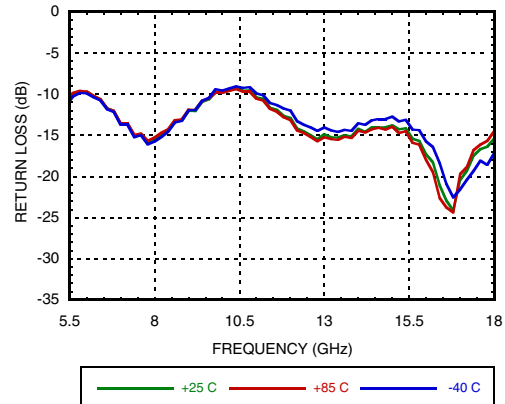

P1dB vs. Temperature

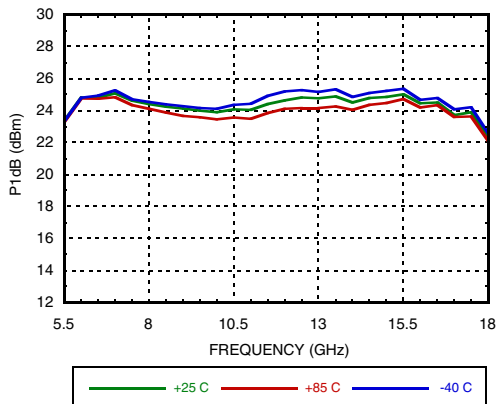

P1dB vs. Supply Voltage

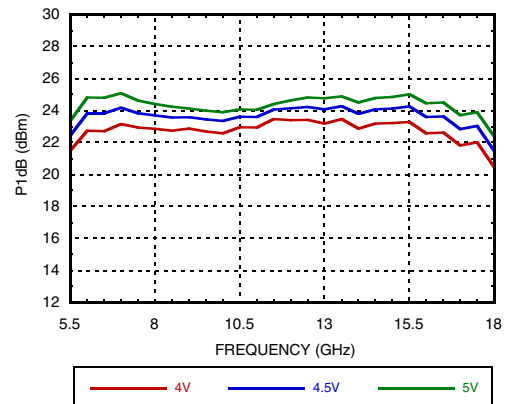

**GaAs pHEMT MMIC MEDIUM
POWER AMPLIFIER, 5.5 - 18 GHz**

Psat vs. Temperature

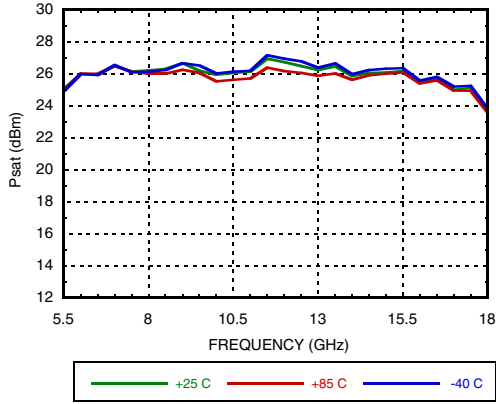

Psat vs. Supply Voltage

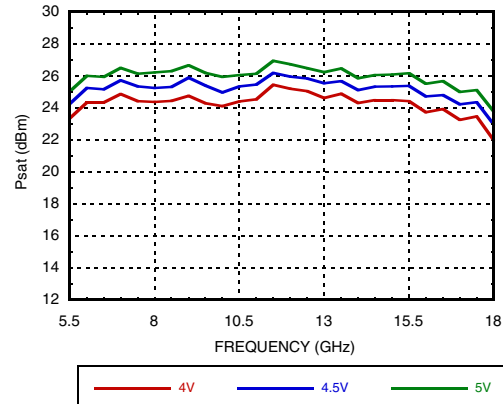

P1dB vs. Supply Current

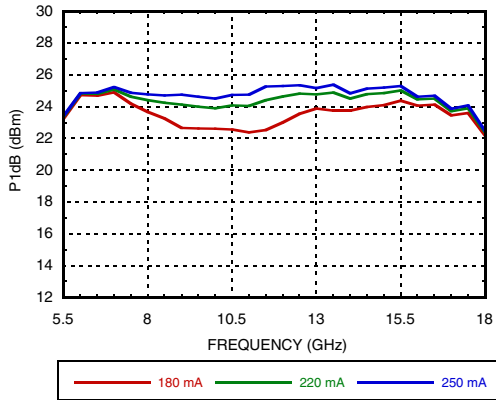

Psat vs. Supply Current

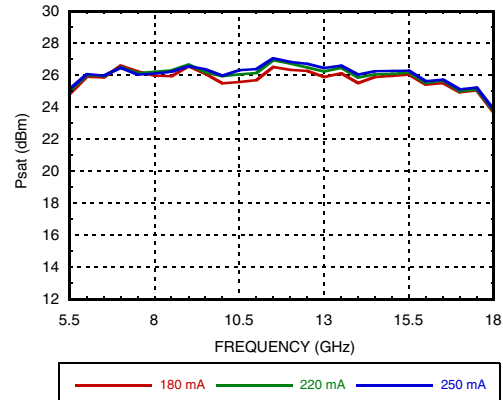

Output IP3 vs. Temperature [1]

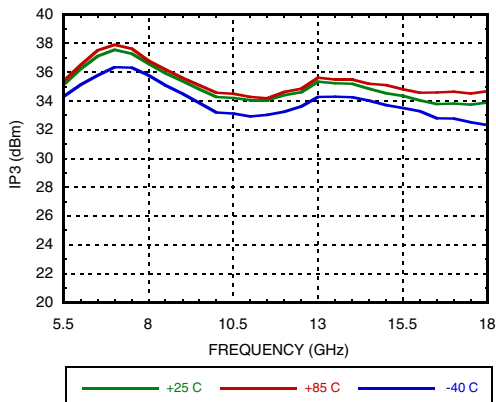

Output IP3 vs. Supply Current [1]

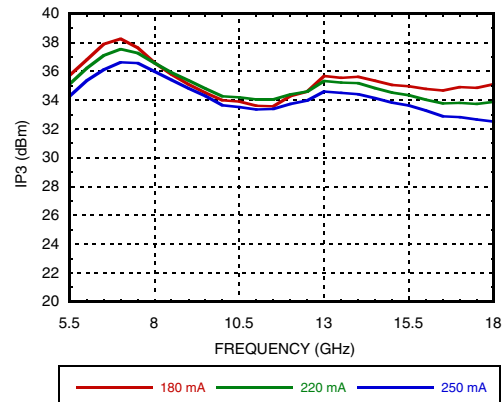

[1] Pout/Tone = +12 dBm

GaAs pHEMT MMIC MEDIUM POWER AMPLIFIER, 5.5 - 18 GHz

Output IP3 vs. Supply Voltage [1]

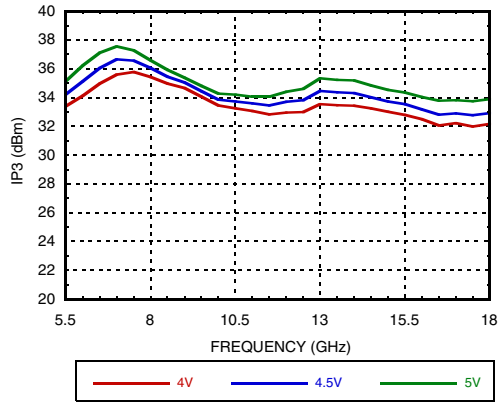

Output IM3 @ Vdd = +4V

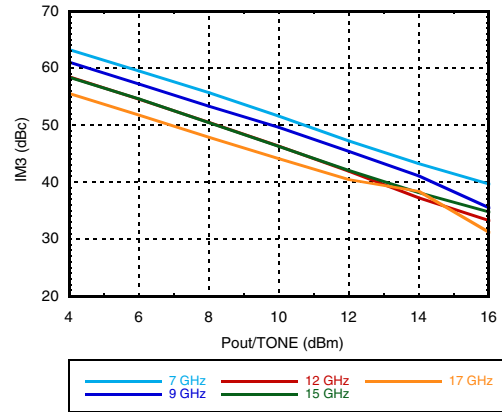

Output IM3 @ Vdd = +4.5V

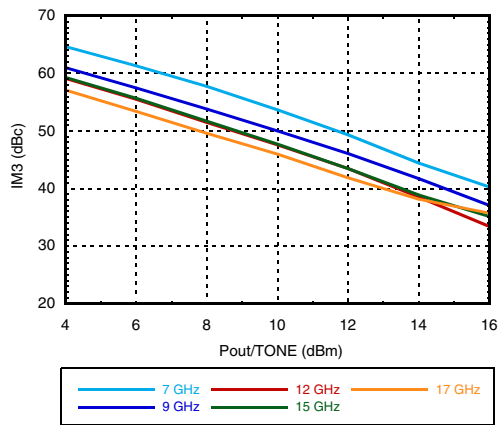

Output IM3 @ Vdd = +5V

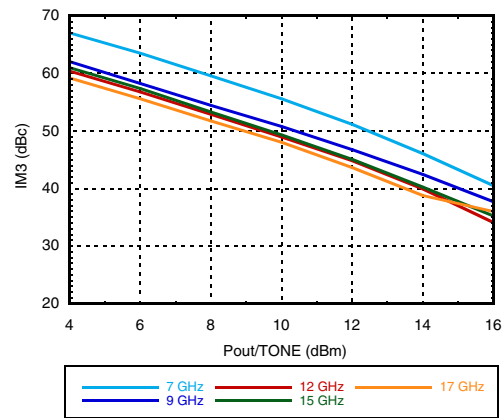

Power Compression @ 12 GHz

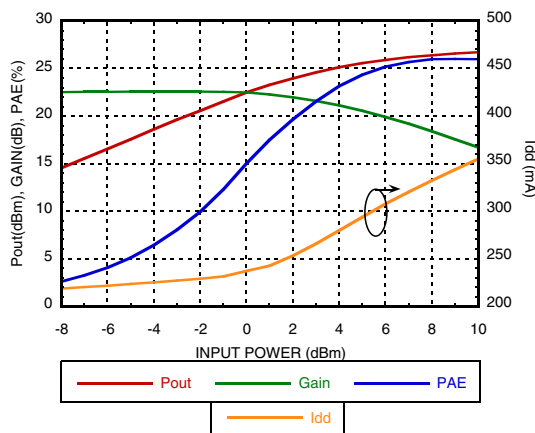

Gain & Power vs. Supply Current

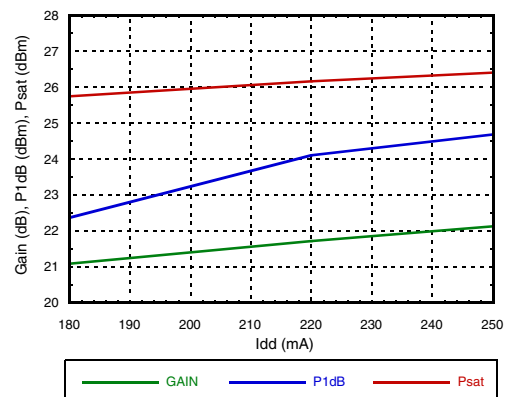

[1] Pout/Tone = +12 dBm

GaAs pHEMT MMIC MEDIUM POWER AMPLIFIER, 5.5 - 18 GHz

Gain & Power vs. Supply Voltage

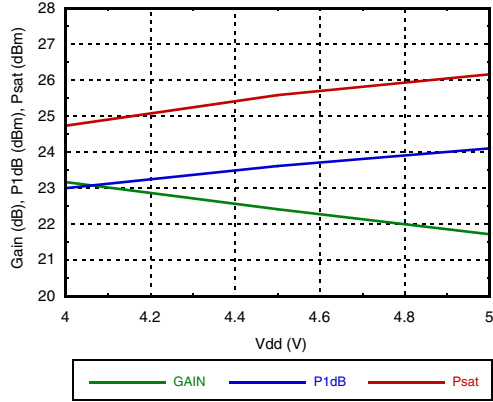

Reverse Isolation vs. Temperature

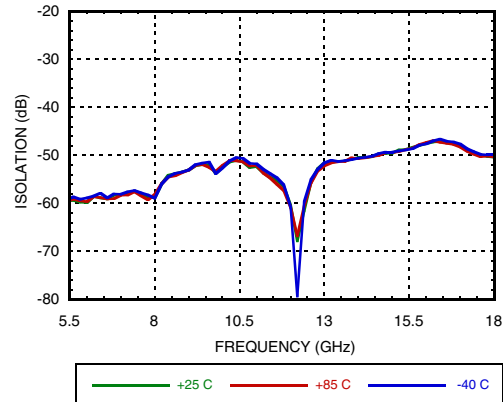

Power Dissipation

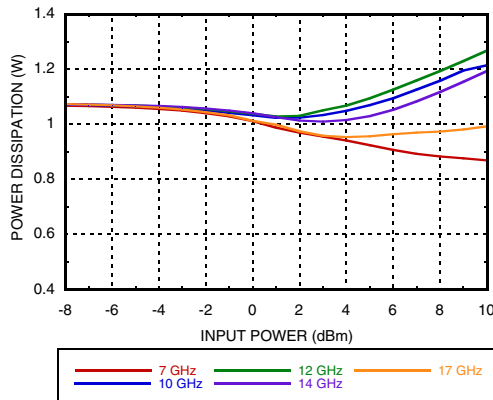

Detector Voltage vs. Temperature @ 6 GHz

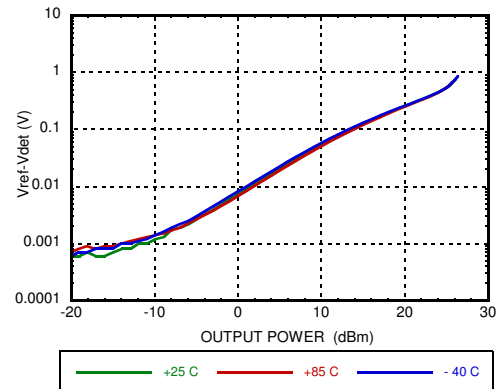

Detector Voltage vs. Temperature @ 12 GHz

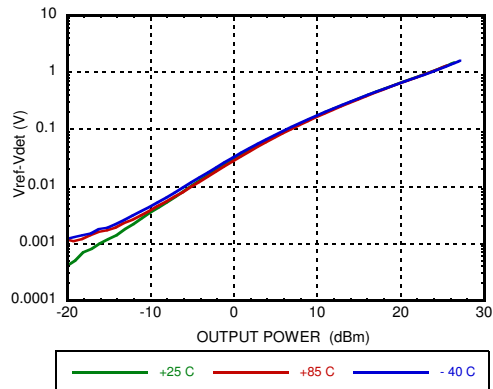

Detector Voltage vs. Temperature @ 18 GHz

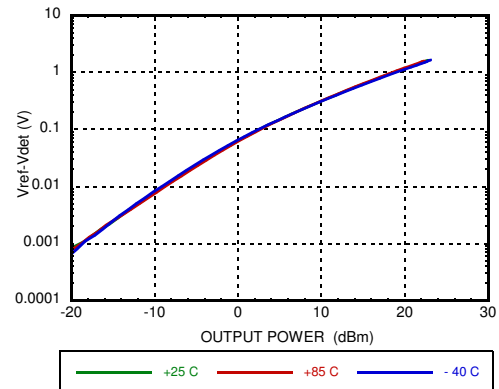

**GaAs pHEMT MMIC MEDIUM
POWER AMPLIFIER, 5.5 - 18 GHz**

**Additive Phase Noise Vs Offset Frequency,
RF Frequency = 8 GHz,
RF Input Power = 3 dBm (P1dB)**

I_{ddq} Vs V_{gg}

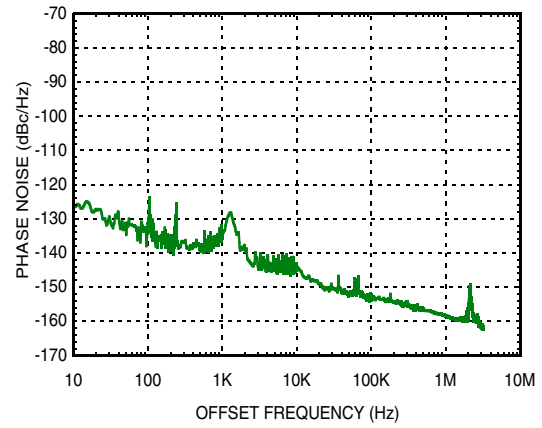
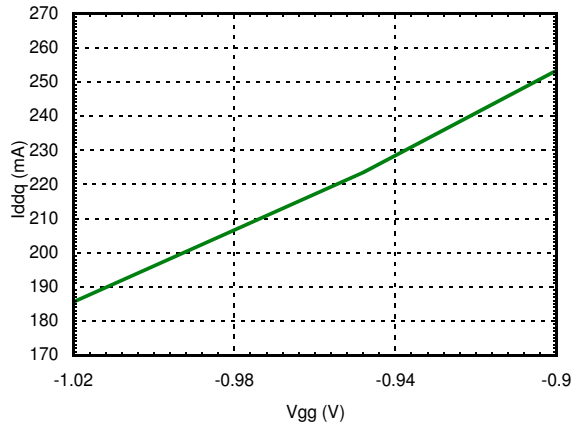

Notes:

GaAs pHEMT MMIC MEDIUM POWER AMPLIFIER, 5.5 - 18 GHz

Absolute Maximum Ratings

Drain Bias Voltage (Vdd)	5.5V
RF Input Power (RFIN)	20 dBm
Channel Temperature	175 °C
Continuous Pdiss (T=85 °C) (derate 20mW/°C)	1.81W
Thermal Resistance (R _{TH}) (junction to ground paddle)	49.8 °C/W
Operating Temperature	-40°C to +85°C
Storage Temperature	-65°C to 150°C
ESD Sensitivity (HBM)	Class 0, Passed 100V

Typical Supply Current vs. Vdd

Vdd (V)	Idd (mA)
+4	220
+4.5	220
+5	220

Adjust Vgg1 to achieve Idd = 220mA



**ELECTROSTATIC SENSITIVE DEVICE
OBSERVE HANDLING PRECAUTIONS**

Outline Drawing

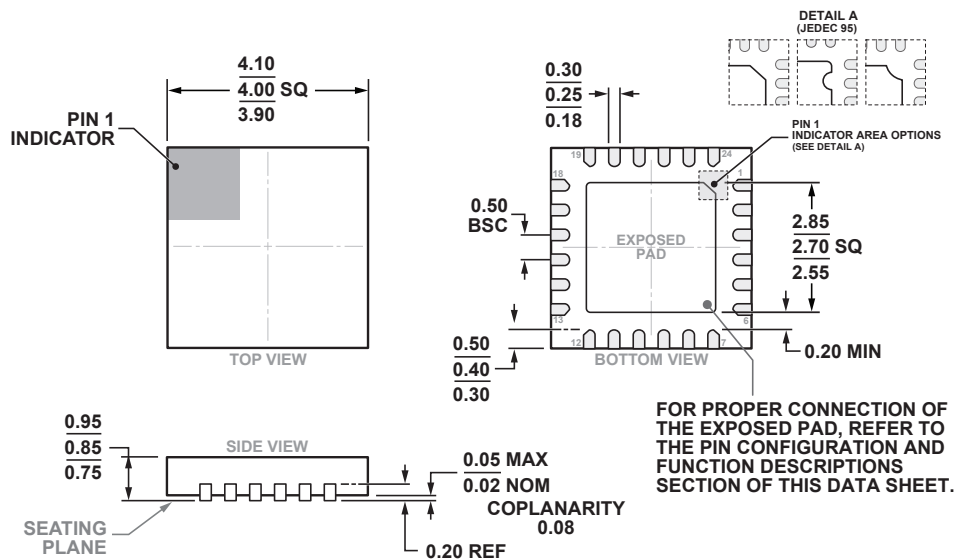

24-Lead Lead Frame Chip Scale Package [LFCSP]
 4 mm x 4 mm Body and 0.85 mm Package Height
 (HCP-24-3)
 Dimensions shown in millimeters

Package Information



Part Number	Package Body Material	Lead Finish	MSL Rating ^[2]	Package Marking ^[1]
HMC1082LP4E	RoHS-compliant Low Stress Injection Molded Plastic	100% matte Sn	MSL1	H1082 XXXX

[1] 4-Digit lot number XXXX

[2] Max peak reflow temperature of 260 °C

GaAs pHEMT MMIC MEDIUM POWER AMPLIFIER, 5.5 - 18 GHz

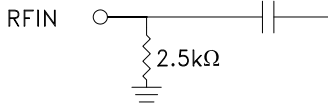
Pin Descriptions

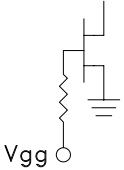
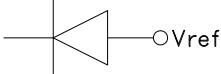
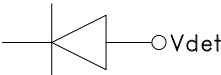
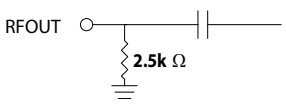
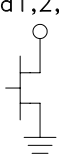
Pin Number	Function	Description	Pin Schematic
1, 2, 5, 6, 7, 8, 10, 13, 14, 17, 18, 19, 21, 23	N/C	These pins are not connected internally, however all data shown herein was measured with these pins connected to RF/DC ground externally.	
3	RF IN	This pin is DC coupled and matched to 50 Ohms.	
4, 15	GND	These pins and package bottom must be connected to RF/DC ground.	
9	Vgg	Gate control for amplifier. External bypass capacitors of 1000pF, 100pF and 2.2uF are required.	
11	Vref	DC bias of diode biased through external resistor used for temperature compensation of Vdet. See application circuit.	
12	Vdet	DC voltage representing RF output power rectified by diode which is biased through an external resistor. See application circuit.	
16	RF OUT	This pin is DC coupled and matched to 50 Ohms.	
24, 22, 20	Vdd1, Vdd2, Vdd3	Drain bias voltage for amplifier. External bypass capacitors of 1000pF, 100pF and 2.2uF are required.	

**GaAs pHEMT MMIC MEDIUM
POWER AMPLIFIER, 5.5 - 18 GHz**

Application Circuit

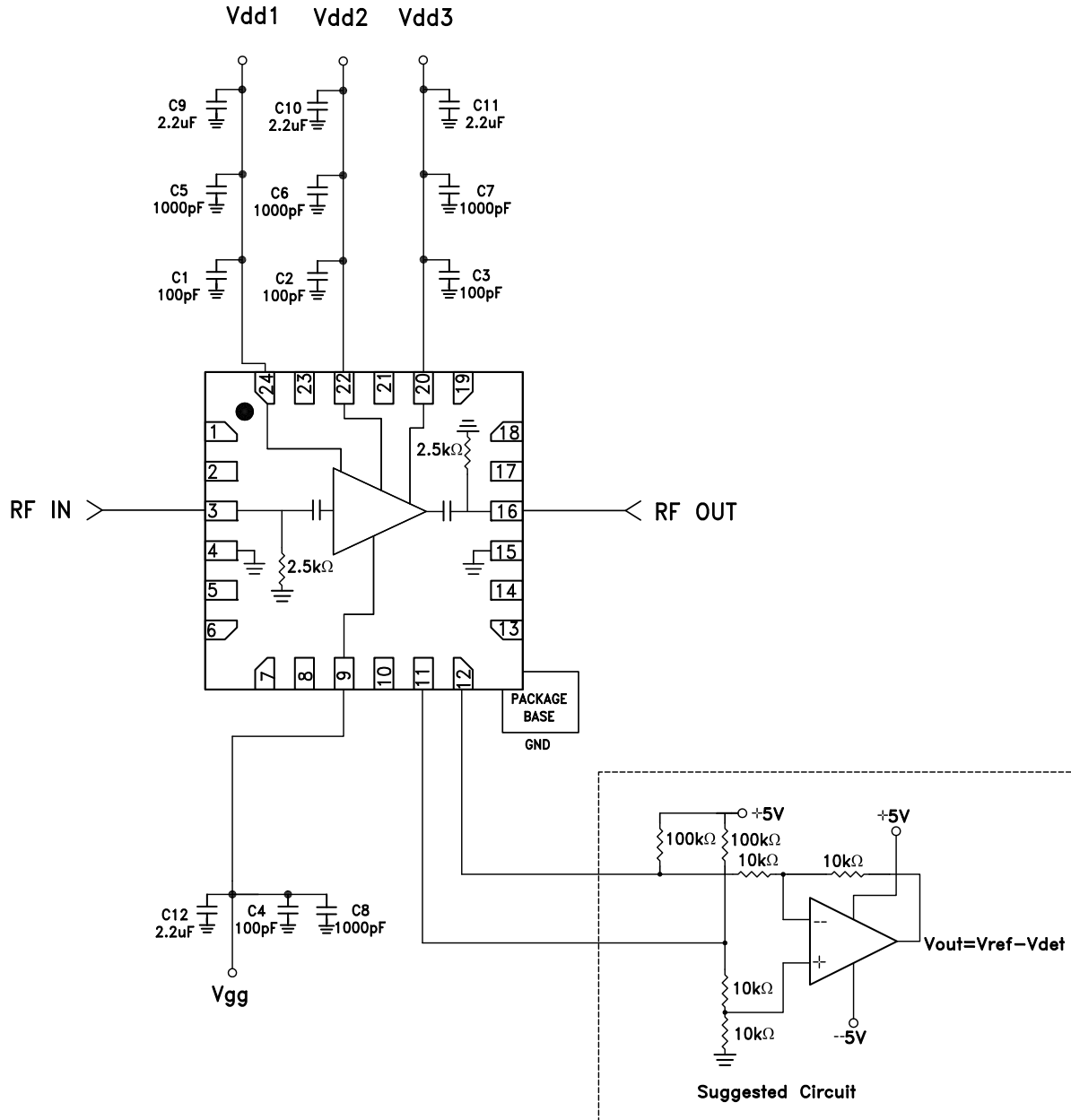

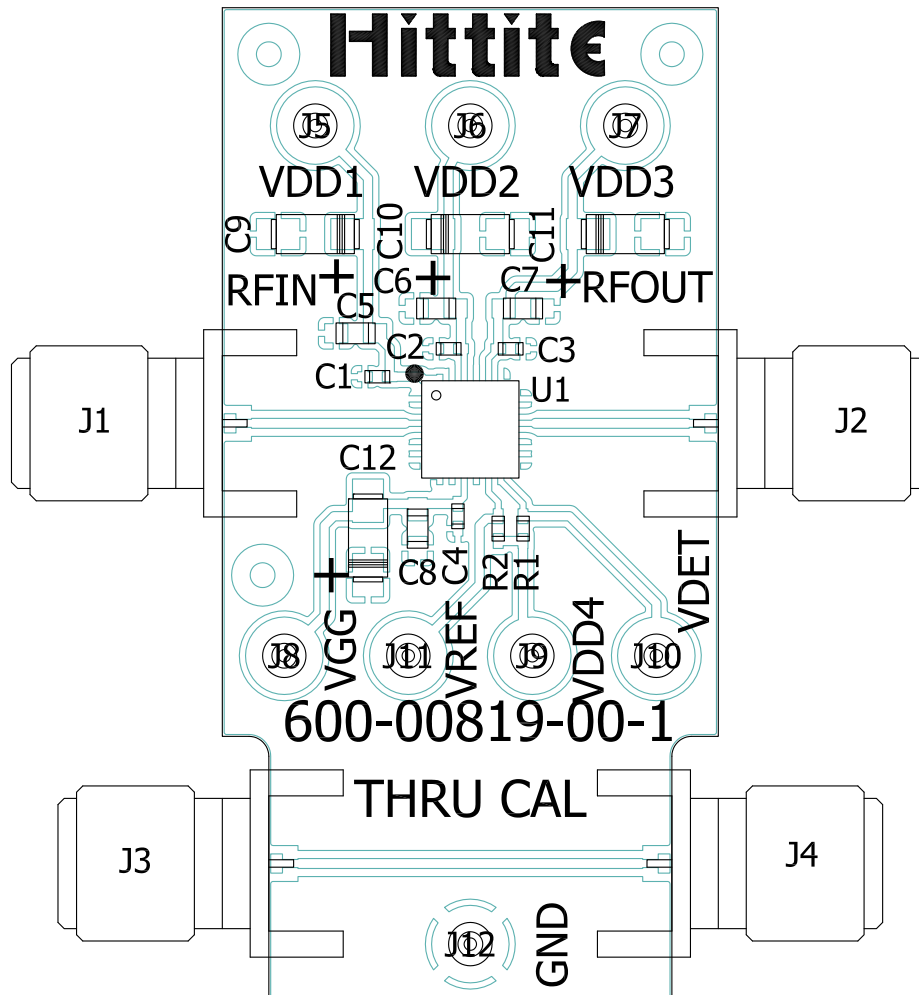
**GaAs pHEMT MMIC MEDIUM
POWER AMPLIFIER, 5.5 - 18 GHz**
Evaluation PCB

List of Materials for Evaluation PCB EV1HMC1082LP4 [1]

Item	Description
J1, J2	PCB Mount SMA RF Connector
J5 - J12	DC Pin
C1 - C4	100pF Capacitor, 0402 Pkg.
C5 - C8	1000pF Capacitor, 0402 Pkg
C9 - C12	2.2uF Capacitor, 0402 Pkg.
R1, R2	40.2k Ohm Resistor, 0402 Pkg.
U1	HMC1082LP4E
PCB [2]	600-00819-00 Evaluation Board

[1] Reference this number when ordering Complete Evaluation PCB

[2] Circuit Board Material: Rogers 4350 or Arlon 25FR

The circuit board used in the application should use RF circuit design techniques. Signal lines should have 50 Ohm impedance while the package ground leads and exposed paddle should be connected directly to the ground plane similar to that shown. A sufficient number of via holes should be used to connect the top and bottom ground planes. The evaluation circuit board shown is available from Analog Devices upon request.

Данный компонент на территории Российской Федерации

Вы можете приобрести в компании MosChip.

Для оперативного оформления запроса Вам необходимо перейти по данной ссылке:

<http://moschip.ru/get-element>

Вы можете разместить у нас заказ для любого Вашего проекта, будь то серийное производство или разработка единичного прибора.

В нашем ассортименте представлены ведущие мировые производители активных и пассивных электронных компонентов.

Нашей специализацией является поставка электронной компонентной базы двойного назначения, продукции таких производителей как XILINX, Intel (ex.ALTERA), Vicor, Microchip, Texas Instruments, Analog Devices, Mini-Circuits, Amphenol, Glenair.

Сотрудничество с глобальными дистрибьюторами электронных компонентов, предоставляет возможность заказывать и получать с международных складов практически любой перечень компонентов в оптимальные для Вас сроки.

На всех этапах разработки и производства наши партнеры могут получить квалифицированную поддержку опытных инженеров.

Система менеджмента качества компании отвечает требованиям в соответствии с ГОСТ Р ИСО 9001, ГОСТ РВ 0015-002 и ЭС РД 009

Офис по работе с юридическими лицами:

105318, г.Москва, ул.Щербаковская д.3, офис 1107, 1118, ДЦ «Щербаковский»

Телефон: +7 495 668-12-70 (многоканальный)

Факс: +7 495 668-12-70 (доб.304)

E-mail: info@moschip.ru

Skype отдела продаж:

moschip.ru

moschip.ru_4

moschip.ru_6

moschip.ru_9