

EAO – Your Expert Partner for  
Human Machine Interfaces



## EAO Product Information

Series 84





Description .....	3
Product Assembly .....	4
Mounting instruction .....	6
Devices raised mounting .....	7
Devices flush mounting .....	9
Accessories.....	13
Technical Data.....	27
Application guidelines.....	30
Drawings.....	31
Index.....	45

## Product Information

### General notes

The Series 84 consists of indicators, pushbuttons and emergency-stop switches. The indicators and pushbuttons are a modular system of lens, actuator, switching element and a variety of means of connection and mounting. Different front protection of IP 67, IP 65 or IP 40 ensure that the pushbuttons are suited for industrial use.

Anodized aluminium parts can have visible variations due production-technical reasons.

### Mounting

The actuators of the Series 84 are inserted in a 22.5 mm diameter mounting hole and the switching units are clipped on to the rear of the actuators. The pushbutton system can be mounted as a complete unit (actuator and switching unit). Mounting from the front with the wiring already attached is also possible.

When mounted on printed circuit boards the actuators are inserted in the mounting hole 22.5 mm dia. and the switching elements are fixed on the board. The printed circuit board is connected to the preassembled actuator by means of the mounting flange. There is no need for subsequent adjustment or spacing studs.

### Lenses

The lenses are available in various colours and made either from plastic or anodized aluminium.

### Marking

The marking plates of the Series 84 can be marked by engraving or hot stamping.

Specific symbols and markings are available on request.

The lenses are without holder not engravable, since by mounting no accurate position of the engraving text is reached.

### Illumination

To ensure full illumination, the switching elements can be supplied with integrated single LEDs in the colours red, orange, yellow, green, blue or white. The series resistor is integrated.

Luminosity and wave length scattering caused by the technology used in the LED manufacturing processes may lead to visual differences in our products.

### Emergency-stop pushbutton, foolproof

The E-stop pushbutton can be mounted in front panels with a thickness between 1 and 4 mm. It has a low behind-panel depth of 13.5 mm (max.) respectively 18.5 mm with plug-in terminlas and can be safely and easily adapted to PCBs of different heights. The front protection degree is IP 65.

Importantly, the Series 84 emergency-stop requires no additional assembly because of its single-piece 'monoblock' design.

The switch's status is clearly indicated by a black or green colour ring on the shaft, and the foolproof actuator design conforms to DIN EN ISO 13850 and EN IEC 60947.

It can be supplied with LED illumination that is visible even from the side.

## Specimen order

### Indicator :

- Indicator actuator, IP67 84-0100.0

### Essential accessories :

- Lens plastic blue 84-7111.600  
 - Illumination element 84-8001.6620  
 Single-LED blue 24VDC, plug-in terminal

or

### Indicator with PCB terminal :

- Indicator actuator, IP67 84-3100.1

### Essential accessories :

- Lens plastic red 84-7111.200  
 - Illumination element with PCB terminal 92-800.042  
 - Single-LED red 2.1VDC 10-2602.3202L  
 - Mounting flange 92-960.0

*We reserve the right to modify technical data  
 All dimensions in mm*

## Indicator and pushbutton illuminative, 25 mm dia.



- 1 Lens
- 2 Marking plate
- 3 Lens holder
- 4 Actuator housing
- 5 Outer sealing
- 6 Inner sealing
- 7 Front panel
- 8 Fixing nut
- 9 Switching-/Illumination element with plug-in terminal (solderable)

## Indicator and pushbutton illuminative, 40 mm dia.



- 1 Lens
- 2 Marking plate
- 3 Lens holder
- 4 Actuator housing
- 5 Sealing
- 6 Front panel
- 7 Fixing nut
- 8 Switching-/Illumination element with flat ribbon cable

## Indicator and pushbutton illuminative, 25 mm dia., PCB version



- 1 Lens
- 2 Marking plate
- 3 Lens holder
- 4 Actuator housing
- 5 Sealing
- 6 Front panel
- 7 Fixing nut
- 8 Mounting flange
- 9 Switching-/Illumination element with PCB terminal
- 10 PCB
- 11 Fixing screws

## Emergency-stop pushbutton



- 1 Emergency-stop pushbutton
- 2 Fixing nut
- 3 Position indication ring green or black

## Arrangement mounting flange for switching- and illumination element, PCB mounting



The arrangement of the mounting flanges and their number is determined by the size of the front panel or PCB. To ensure uniform, tactile switching, we recommend a layout of the flanges as per adjacent sketch.

For large PCBs with several switching elements we recommend the following procedure :

1. Fit the actuator to the front panel.
2. Clip the mounting flange to the rear of the intended actuator.
3. Screw the PCB with the components soldered to it to the assembled mounting flange.

This arrangement applies to PCBs 1.6 mm thick.

## Dismantling mounting flange

The tool 84-998 must be used for removing the mounting flange from the actuator. Before removing the flange, the PCB fixing screws must be loosened.



## Emergency-stop pushbutton, foolproof EN IEC 60947-5-5, complete

Application as per DIN EN ISO 13850 and EN 60204-1



	Front protection	Switching action	Mushroom had cap	Illumination	Terminals	Contacts	Ø 32 mm Typ-Nr.	Component layout	Mounting dimensions	Technical drawing	Circuit drawing	
<b>Emergency-stop pushbutton, foolproof EN IEC 60947-5-5, complete</b> Position indication ring black Twist to unlock clockwise	IP 65	MA	Plastic red	without	FR	1 NC	<b>84-5020.0040</b>	2	2	17	8	0.036
						1 NC + 1 NO	<b>84-5030.0040</b>	2	2	17	9	0.036
						2 NC	<b>84-5040.0040</b>	2	2	17	10	0.036
					PT 2.8 s	1 NC	<b>84-5020.0020</b>	1	2	17	8	0.028
						1 NC + 1 NO	<b>84-5030.0020</b>	1	2	17	9	0.028
						2 NC	<b>84-5040.0020</b>	1	2	17	10	0.028
Position indication ring black Twist to unlock clockwise LED operating voltage: 5 ... 30 VDC Current consumption: 9.7 ... 12.4 mA	IP 65	MA	Plastic red	LED red	FR	1 NC	<b>84-5021.2B40</b>	2	2	17	11	0.036
						1 NC + 1 NO	<b>84-5031.2B40</b>	2	2	17	12	0.036
						2 NC	<b>84-5041.2B40</b>	2	2	17	13	0.036
					PT 2.8 s	1 NC	<b>84-5021.2B20</b>	1	2	17	11	0.028
						1 NC + 1 NO	<b>84-5031.2B20</b>	1	2	17	12	0.028
						2 NC	<b>84-5041.2B20</b>	1	2	17	13	0.028
Position indication ring green Twist to unlock clockwise	IP 65	MA	Plastic red	without	FR	1 NC	<b>84-5120.0040</b>	2	2	17	8	0.036
						1 NC + 1 NO	<b>84-5130.0040</b>	2	2	17	9	0.036
						2 NC	<b>84-5140.0040</b>	2	2	17	10	0.036
					PT 2.8 s	1 NC	<b>84-5120.0020</b>	1	2	17	8	0.028
						1 NC + 1 NO	<b>84-5130.0020</b>	1	2	17	9	0.028
						2 NC	<b>84-5140.0020</b>	1	2	17	10	0.028
Position indication ring green Twist to unlock clockwise LED operating voltage: 5 ... 30 VDC Current consumption: 9.7 ... 12.4 mA	IP 65	MA	Plastic red	LED red	FR	1 NC	<b>84-5121.2B40</b>	2	2	17	11	0.036
						1 NC + 1 NO	<b>84-5131.2B40</b>	2	2	17	12	0.036
						2 NC	<b>84-5141.2B40</b>	2	2	17	13	0.036
					PT 2.8 s	1 NC	<b>84-5121.2B20</b>	1	2	17	10	0.028
						1 NC + 1 NO	<b>84-5131.2B20</b>	1	2	17	12	0.028
						2 NC	<b>84-5141.2B20</b>	1	2	17	13	0.028

Standard version:

Flat ribbon-cable length 300 mm; Plug-in terminal 2.8 x 0.5 mm.

Other options on request:

Customisation of flat ribbon-cable and connectors.

Switching action: MA = Maintained action

Terminals: FR = Flat ribbon cable, PT 2.8 s = Plug-in terminal 2.8 mm (solderable)

Contacts: NC = Normally closed, NO = Normally open

Component layout from page 31, Mounting dimensions from page 34, Technical drawing from page 35, Circuit drawing from page 43

## Stop pushbutton grey, complete



	Front protection	Switching action	Mushroom had cap	Illumination	Terminals	Contacts	Ø 32 mm Typ-Nr.	Component layout	Mounting dimensions	Technical drawing	Circuit drawing	
<b>Stop pushbutton grey, complete</b> Position indication ring black Twist to unlock clockwise	IP 65	MA	Plastic grey	without	FR	1 NC	<b>84-6820.0040</b>	2	2	17	8	0.036
						1 NC + 1 NO	<b>84-6830.0040</b>	2	2	17	9	0.036
						2 NC	<b>84-6840.0040</b>	2	2	17	10	0.036
					PT 2.8 s	1 NC	<b>84-6820.0020</b>	1	2	17	8	0.028
						1 NC + 1 NO	<b>84-6830.0020</b>	1	2	17	9	0.028
						2 NC	<b>84-6840.0020</b>	1	2	17	10	0.028
Position indication ring black Twist to unlock clockwise LED operating voltage: 5 ... 30 VDC Current consumption: 9.7 ... 12.4 mA	IP 65	MA	Plastic grey	LED red	FR	1 NC	<b>84-6821.2B40</b>	2	2	17	11	0.036
						1 NC + 1 NO	<b>84-6831.2B40</b>	2	2	17	12	0.036
						2 NC	<b>84-6841.2B40</b>	2	2	17	13	0.036
					PT 2.8 s	1 NC	<b>84-6821.2B20</b>	1	2	17	11	0.028
						1 NC + 1 NO	<b>84-6831.2B20</b>	1	2	17	12	0.028
						2 NC	<b>84-6841.2B20</b>	1	2	17	13	0.028

Standard version:

Flat ribbon-cable length 300 mm; Plug-in terminal 2.8 x 0.5 mm.

Other options on request:

Customisation of flat ribbon-cable and connectors.

Switching action: MA = Maintained action

Terminals: FR = Flat ribbon cable, PT 2.8 s = Plug-in terminal 2.8 mm (solderable)

Contacts: NC = Normally closed, NO = Normally open

Component layout from page 31, Mounting dimensions from page 34, Technical drawing from page 35, Circuit drawing from page 43

## Indicator actuator

Illuminated lens, non-illuminated bezel



### Essential Accessories:

-  Illumination element page 17
-  Lens plastic page 13

	Front protection	Front ring	Ø 25 mm Typ-Nr.	Mounting dimensions	Technical drawing	
<b>Indicator actuator</b>	IP 40	Plastic black	<b>84-3100.0</b>	1	16	0.004
	IP 67	Aluminium natural	<b>84-0200.7</b>	1	16	0.008
		Plastic black	<b>84-0100.0</b>	1	16	0.003

Mounting dimensions from page 34, Technical drawing from page 35

## Illuminated pushbutton actuator

Illuminated lens, non-illuminated bezel



### Essential Accessories:

-  Lens plastic page 13
-  Switching element illuminated page 19

	Switching action	Front protection	Front ring	Ø 40 mm Typ-Nr.	Ø 25 mm Typ-Nr.	Mounting dimensions	Technical drawing	Circuit drawing	
<b>Illuminated pushbutton actuator</b>	M	IP 67	Aluminium natural	<b>84-1221.7</b>		3	18	4	0.022
		IP 40	Plastic black		<b>84-2101.0</b>	1	16	4	0.004
	IP 67	Aluminium black		<b>84-1201.0</b>	1	16	4	0.008	
		Aluminium blue		<b>84-1201.6</b>	1	16	4	0.008	
		Aluminium gold		<b>84-1201.4</b>	1	16	4	0.008	
		Aluminium natural		<b>84-1201.7</b>	1	16	4	0.008	
		Aluminium olive-green		<b>84-1201.5</b>	1	16	4	0.008	
		Aluminium red		<b>84-1201.2</b>	1	16	4	0.008	
		Plastic black		<b>84-1101.0</b>	1	16	4	0.003	

Switching action: M = Momentary action

Mounting dimensions from page 34, Technical drawing from page 35, Circuit drawing from page 43

## Pushbutton actuator

Non-illuminated lens and bezel



### Essential Accessories:

-  Lens metal page 14
-  Switching element non-illuminated page 20

	Front protection	Switching action	Front ring	Ø 40 mm Typ-Nr.	Ø 25 mm Typ-Nr.	Mounting dimensions	Technical drawing	Circuit drawing	
<b>Pushbutton actuator</b>	IP 67	M	Aluminium natural	<b>84-1221.7</b>		3	18	4	0.022
	IP 40	M	Plastic black		<b>84-2101.0</b>	1	16	4	0.004
	IP 67	M	Aluminium black		<b>84-1201.0</b>	1	16	4	0.008
			Aluminium blue		<b>84-1201.6</b>	1	16	4	0.008
			Aluminium gold		<b>84-1201.4</b>	1	16	4	0.008
			Aluminium natural		<b>84-1201.7</b>	1	16	4	0.008
			Aluminium olive-green		<b>84-1201.5</b>	1	16	4	0.008
			Aluminium red		<b>84-1201.2</b>	1	16	4	0.008
			Plastic black		<b>84-1101.0</b>	1	16	4	0.003

Switching action: M = Momentary action

Mounting dimensions from page 34, Technical drawing from page 35, Circuit drawing from page 43

## Indicator actuator with ring illumination (illuminated bezel)



### Essential Accessories:

-  Illumination element page 17
-  Lens metal for Ring illumination page 14

	Front protection	Front ring	Ø 25 mm Typ-Nr.	Mounting dimensions	Technical drawing	
<b>Indicator actuator with ring illumination (illuminated bezel)</b>	IP 67	Plastic translucent	<b>84-0090.7</b>	1	16	0.006

Accessories for ring illumination:

Essential lenses Typ-Nr. 84-7202.x00A and 84-7205.x00A

Bi-colour illumination elements are not recommended.

Mounting dimensions from page 34, Technical drawing from page 35

## Pushbutton actuator with ring illumination (illuminated bezel)



### Essential Accessories:

-  Lens metal for Ring illumination page 14
-  Switching element illuminated page 19

	Switching action	Front protection	Front ring	Ø 25 mm Typ-Nr.	Mounting dimensions	Technical drawing	Circuit drawing	
<b>Pushbutton actuator with ring illumination (illuminated bezel)</b>	M	IP 67	Plastic translucent	<b>84-1091.7</b>	1	16	4	0.006

Accessories for ring illumination:

Essential lenses Typ-Nr. 84-7202.x00A and 84-7205.x00A

Bi-colour switching elements are not recommended.

Switching action: M = Momentary action

Mounting dimensions from page 34, Technical drawing from page 35, Circuit drawing from page 43

## Indicator actuator with ring illumination (illuminated multi-colour bezel)



### Essential Accessories:

-  Illumination element PCB mounting page 21
-  Lens plastic page 13
-  Mounting flange page 21
-  Single-LED page 22

	Front protection	Front ring	Ø 25 mm Typ-Nr.	Mounting dimensions	Technical drawing	
<b>Indicator actuator with ring illumination (illuminated multi-colour bezel)</b>	IP 67	Plastic transparent	<b>84-0080.7</b>	1	16	0.006

Mounting dimensions from page 34, Technical drawing from page 35

## Pushbutton actuator with ring illumination (illuminated multi-colour bezel)



### Essential Accessories:

-  Lens plastic page 13
-  Mounting flange page 21
-  Single-LED page 22
-  Switching element PCB mounting illuminative page 21

	Switching action	Front protection	Front ring	Ø 25 mm Typ-Nr.	Mounting dimensions	Technical drawing	Circuit drawing	
<b>Pushbutton actuator with ring illumination (illuminated multi-colour bezel)</b>	M	IP 67	Plastic transparent	<b>84-1081.7</b>	1	16	4	0.006

Switching action: M = Momentary action

Mounting dimensions from page 34, Technical drawing from page 35, Circuit drawing from page 43

## Front

### Lens plastic

	Mounting type	Lens	Ø 25 mm Typ-Nr.	
<b>Lens plastic</b> flush - level, illuminative	level with bezel	blue transparent	<b>84-7111.600</b>	0.001
		colourless transparent	<b>84-7111.700</b>	0.001
		green transparent	<b>84-7111.500</b>	0.001
		orange transparent	<b>84-7111.300</b>	0.001
		red transparent	<b>84-7111.200</b>	0.001
		yellow transparent	<b>84-7111.400</b>	0.001
flush - level, non-illuminative	level with bezel	black opaque	<b>84-7121.000</b>	0.001
	level with bezel	grey opaque	<b>84-7121.800</b>	0.001
flush - raised, illuminative	raised above bezel	blue transparent	<b>84-7115.600</b>	0.001
		colourless transparent	<b>84-7115.700</b>	0.001
		green transparent	<b>84-7115.500</b>	0.001
		orange transparent	<b>84-7115.300</b>	0.001
		red transparent	<b>84-7115.200</b>	0.001
		yellow transparent	<b>84-7115.400</b>	0.001
flush - raised, non-illuminative	raised above bezel	black opaque	<b>84-7125.000</b>	0.001
		grey opaque	<b>84-7125.800</b>	0.001



### Marking plate for lens plastic

can be hot stamped

	Marking plate	Typ-Nr.	
<b>Marking plate for lens plastic</b>	Plastic colourless transparent	<b>61-9707.7</b>	0.001



### Lens plastic with symbol

	Mounting type	Symbol	Lens	Ø 25 mm Typ-Nr.	
<b>Lens plastic with symbol</b> flush - level, illuminative	level with bezel	ON/OFF	blue transparent	<b>84-7111.602</b>	0.002
			colourless transparent	<b>84-7111.702</b>	0.002
			green transparent	<b>84-7111.502</b>	0.002
			red transparent	<b>84-7111.202</b>	0.002
		Ring	blue transparent	<b>84-7111.601</b>	0.002
			colourless transparent	<b>84-7111.701</b>	0.002
			green transparent	<b>84-7111.501</b>	0.002
			orange transparent	<b>84-7111.301</b>	0.002
			red transparent	<b>84-7111.201</b>	0.002
			yellow transparent	<b>84-7111.401</b>	0.002
		Stand by	blue transparent	<b>84-7111.603</b>	0.002
			colourless transparent	<b>84-7111.703</b>	0.002
			green transparent	<b>84-7111.503</b>	0.002
			red transparent	<b>84-7111.203</b>	0.002



The silvery coat is being applied on the lens (screen print) with an additional protective lacquer.

## Lens metal

	Mounting type	Lens	Ø 25 mm Typ-Nr.	
<b>Lens metal</b> convex - level, non-illuminative	level with bezel	Aluminium black	<b>84-7202.000</b>	0.003
		Aluminium blue	<b>84-7202.600</b>	0.003
		Aluminium gold	<b>84-7202.400</b>	0.003
		Aluminium natural	<b>84-7202.800</b>	0.003
		Aluminium olive-green	<b>84-7202.500</b>	0.003
		Aluminium red	<b>84-7202.200</b>	0.003
flush - level, non-illuminative	level with bezel	Aluminium black	<b>84-7201.000</b>	0.003
		Aluminium blue	<b>84-7201.600</b>	0.003
		Aluminium gold	<b>84-7201.400</b>	0.003
		Aluminium natural	<b>84-7201.800</b>	0.003
		Aluminium olive-green	<b>84-7201.500</b>	0.003
		Aluminium red	<b>84-7201.200</b>	0.003
flush - raised, non-illuminative	raised above bezel	Aluminium black	<b>84-7205.000</b>	0.003
		Aluminium blue	<b>84-7205.600</b>	0.003
		Aluminium gold	<b>84-7205.400</b>	0.003
		Aluminium natural	<b>84-7205.800</b>	0.003
		Aluminium olive-green	<b>84-7205.500</b>	0.003
		Aluminium red	<b>84-7205.200</b>	0.003



## Lens metal for Ring illumination

	Mounting type	Lens	Ø 25 mm Typ-Nr.	
<b>Lens metal for Ring illumination</b> convex - raised, non-illuminative	raised above bezel	Aluminium black	<b>84-7202.000A</b>	0.004
		Aluminium blue	<b>84-7202.600A</b>	0.004
		Aluminium gold	<b>84-7202.400A</b>	0.004
		Aluminium natural	<b>84-7202.800A</b>	0.004
		Aluminium olive-green	<b>84-7202.500B</b>	0.004
		Aluminium red	<b>84-7202.200A</b>	0.004
flush - raised, non-illuminative	raised above bezel	Aluminium black	<b>84-7205.000A</b>	0.003
		Aluminium blue	<b>84-7205.600A</b>	0.003
		Aluminium gold	<b>84-7205.400A</b>	0.003
		Aluminium natural	<b>84-7205.800A</b>	0.003
		Aluminium olive-green	<b>84-7205.500A</b>	0.003
		Aluminium red	<b>84-7205.200A</b>	0.003





## Lens metal with spot

	Mounting type	Lens	Ø 25 mm Typ-Nr.	
<b>Lens metal with spot</b> flush - level, illuminative	level with bezel	Aluminium black	<b>84-7211.000</b>	0.002
		Aluminium blue	<b>84-7211.600</b>	0.002
		Aluminium gold	<b>84-7211.400</b>	0.002
		Aluminium natural	<b>84-7211.800</b>	0.002
		Aluminium olive-green	<b>84-7211.500</b>	0.002
		Aluminium red	<b>84-7211.200</b>	0.002
flush - raised, illuminative	raised above bezel	Aluminium black	<b>84-7215.000</b>	0.002
		Aluminium blue	<b>84-7215.600</b>	0.002
		Aluminium gold	<b>84-7215.400</b>	0.002
		Aluminium natural	<b>84-7215.800</b>	0.002
		Aluminium olive-green	<b>84-7215.500</b>	0.002
		Aluminium red	<b>84-7215.200</b>	0.002



## Mushroom-head cap

	Mushroom had cap	Ø 32 mm Typ-Nr.	
<b>Mushroom-head cap</b>	Plastic black opaque	<b>84-7124.000A</b>	0.004
	Plastic blue opaque	<b>84-7124.600A</b>	0.004
	Plastic blue transparent	<b>84-7114.600A</b>	0.004
	Plastic green opaque	<b>84-7124.500A</b>	0.004
	Plastic red opaque	<b>84-7124.200A</b>	0.004
	Plastic yellow opaque	<b>84-7124.400A</b>	0.004



## Front protective cap

for flush - level lenses only for protection IP 68

	Front protective cap	Typ-Nr.	
<b>Front protective cap</b>	Silicone natural transparent	<b>84-9103.7</b>	0.001

ATTENTION

when using the front protection cover the external sealing in the actuator has to be removed !



## Legend frame

for devices 25 mm dia.

		Typ-Nr.	Technical drawing	
<b>Legend frame</b> 30 x 50 mm, adhesive, Aluminium black		<b>61-9980.0</b>	7	0.001



Technical drawing from page 35

## Legend plate insert

for Legend frame 61-9980.0

	Typ-Nr.	
<b>Legend plate insert</b> 14.5 x 23.5 mm, adhesive, Aluminium black	<b>704.968.1</b>	0.001
14.5 x 23.5 mm, adhesive, Aluminium natural	<b>704.968.0</b>	0.001



## Blind plug

	Blind plug	Typ-Nr.	Technical drawing	
<b>Blind plug</b> Size 25 mm dia., for mounting hole 22.5 mm dia.	Plastic black	<b>61-9453.0</b>	8	0.006
Size 36 mm dia., for mounting hole 30.5 mm dia.	Plastic black	<b>704.964.8</b>	1	0.007



Technical drawing from page 35

## Backside

### Illumination element

	Protection degree	Illumination	Operating voltage/- current	Terminals	Typ-Nr.	Circuit drawing	
<b>Illumination element</b> LED and built-in resistor included	IP 40	Single-LED blue	12 VDC, 10 mA	FR	<b>84-8001.6340</b>	5	0.010
				PT 2.8 s	<b>84-8001.6320</b>	5	0.005
			24 VDC, 10 mA	FR	<b>84-8001.6640</b>	5	0.010
				PT 2.8 s	<b>84-8001.6620</b>	5	0.005
		Single-LED green	12 VDC, 10 mA	FR	<b>84-8001.5340</b>	5	0.010
				PT 2.8 s	<b>84-8001.5320</b>	5	0.005
			24 VDC, 10 mA	FR	<b>84-8001.5640</b>	5	0.010
				PT 2.8 s	<b>84-8001.5620</b>	5	0.005
		Single-LED orange	12 VDC, 10 mA	FR	<b>84-8001.3340</b>	5	0.010
				PT 2.8 s	<b>84-8001.3320</b>	5	0.005
			24 VDC, 10 mA	FR	<b>84-8001.3640</b>	5	0.010
				PT 2.8 s	<b>84-8001.3620</b>	5	0.005
		Single-LED red	12 VDC, 10 mA	FR	<b>84-8001.2340</b>	5	0.010
				PT 2.8 s	<b>84-8001.2320</b>	5	0.005
			24 VDC, 10 mA	FR	<b>84-8001.2640</b>	5	0.010
				PT 2.8 s	<b>84-8001.2620</b>	5	0.005
		Single-LED white	12 VDC, 10 mA	FR	<b>84-8001.9340</b>	5	0.010
				PT 2.8 s	<b>84-8001.9320</b>	5	0.005
			24 VDC, 10 mA	FR	<b>84-8001.9640</b>	5	0.010
				PT 2.8 s	<b>84-8001.9620</b>	5	0.005
		Single-LED yellow	12 VDC, 10 mA	FR	<b>84-8001.4340</b>	5	0.010
				PT 2.8 s	<b>84-8001.4320</b>	5	0.005
			24 VDC, 10 mA	FR	<b>84-8001.4640</b>	5	0.010
				PT 2.8 s	<b>84-8001.4620</b>	5	0.005



Standard version:

Cable length 300 mm with insulated ferrule; Plug-in terminal 2.8 x 0.8 mm.

Other options on request:

Customisation of cable and connectors; Rear side fully sealed (IP 67).

Protection degree (rear side):

IP 40, upgrade to IP 67 with plug typ-Nr. 84-900 possible; With applications where strong vibrations occur, the plugs may become loose.

Terminals: FR = Flat ribbon cable, PT 2.8 s = Plug-in terminal 2.8 mm (solderable)

Circuit drawing from page 43

## Illumination element with Bi-colour illumination

	Illumination	Operating voltage/- current	Protection degree	Terminals	Typ-Nr.	Circuit drawing	
<b>Illumination element with Bi-colour illumination</b> LED and built-in resistor included	Bi-colour LED red/green	24 VDC, 20 mA	IP 40	PT 2.8 s	<b>84-8005.8620</b>	1	0.005
			IP 67	FR	<b>84-8005.8640</b>	2	0.011
	Bi-colour LED yellow/green	24 VDC, 20 mA	IP 40	PT 2.8 s	<b>84-8005.7620</b>	1	0.005
			IP 67	FR	<b>84-8005.7640</b>	2	0.011



Standard version:

Cable length 300 mm with insulated ferrule; Plug-in terminal 2.8 x 0.8 mm.

Other options on request:

Customisation of cable and connectors; Rear side fully sealed (IP 67).

Best illumination level will be reached with Alu lens with window, Typ-Nr. 84-7215.x00 and 84-7211.x00.

Protection degree (rear side):

- Plug-in terminal IP 40, upgrade to IP 67 with plug typ-Nr. 84-900 possible. With applications where strong vibrations occur, the plugs may become loose.

- Cable connection IP 67, rear side fully sealed. The illumination element of the cable version cannot be disconnected from the actuator any longer.

Terminals: PT 2.8 s = Plug-in terminal 2.8 mm (solderable), FR = Flat ribbon cable

Circuit drawing from page 43

## Switching element illuminated

	Protection degree	Contacts	Illumination	Operating voltage/ current	Terminals	Typ-Nr.	Circuit drawing	
<b>Switching element illuminated</b> LED and built-in resistor included	IP 40	1 NO	Single-LED blue	12 VDC, 10 mA	FR	<b>84-8511.6340</b>	7	0.015
					PT 2.8 s	<b>84-8511.6320</b>	7	0.006
				24 VDC, 10 mA	FR	<b>84-8511.6640</b>	7	0.015
					PT 2.8 s	<b>84-8511.6620</b>	7	0.006
				12 VDC, 10 mA	FR	<b>84-8511.5340</b>	7	0.015
					PT 2.8 s	<b>84-8511.5320</b>	7	0.006
			Single-LED green	24 VDC, 10 mA	FR	<b>84-8511.5640</b>	7	0.015
					PT 2.8 s	<b>84-8511.5620</b>	7	0.006
				12 VDC, 10 mA	FR	<b>84-8511.3340</b>	7	0.015
					PT 2.8 s	<b>84-8511.3320</b>	7	0.006
				24 VDC, 10 mA	FR	<b>84-8511.3640</b>	7	0.015
					PT 2.8 s	<b>84-8511.3620</b>	7	0.006
			Single-LED orange	12 VDC, 10 mA	FR	<b>84-8511.2340</b>	7	0.015
					PT 2.8 s	<b>84-8511.2320</b>	7	0.006
				24 VDC, 10 mA	FR	<b>84-8511.2640</b>	7	0.015
					PT 2.8 s	<b>84-8511.2620</b>	7	0.006
				12 VDC, 10 mA	FR	<b>84-8511.9340</b>	7	0.015
					PT 2.8 s	<b>84-8511.9320</b>	7	0.006
			Single-LED red	24 VDC, 10 mA	FR	<b>84-8511.9640</b>	7	0.015
					PT 2.8 s	<b>84-8511.9620</b>	7	0.006
				12 VDC, 10 mA	FR	<b>84-8511.4340</b>	7	0.015
					PT 2.8 s	<b>84-8511.4320</b>	7	0.006
				24 VDC, 10 mA	FR	<b>84-8511.4640</b>	7	0.015
					PT 2.8 s	<b>84-8511.4620</b>	7	0.006



Standard version:

Cable length 300 mm with insulated ferrule; Plug-in terminal 2.8 x 0.8 mm.

Other options on request:

Customisation of cable and connectors; Rear side fully sealed (IP 67).

Protection degree (rear side):

IP 40, upgrade to IP 67 with plug typ-Nr. 84-900 possible; With applications where strong vibrations occur, the plugs may become loose.

Contacts: NO = Normally open

Terminals: FR = Flat ribbon cable, PT 2.8 s = Plug-in terminal 2.8 mm (solderable)

Circuit drawing from page 43

## Switching element with Bi-colour illumination

	Protection degree	Contacts	Illumination	Operating voltage/ current	Terminals	Typ-Nr.	Circuit drawing	
<b>Switching element with Bi-colour illumination</b> LED and built-in resistor included	IP 67	1 NO	Bi-colour LED red/green	24 VDC, 20 mA	FR	<b>84-8515.8640</b>	3	0.015
			Bi-colour LED yellow/green	24 VDC, 20 mA	FR	<b>84-8515.7640</b>	3	0.015



Protection degree IP 67, rear side fully sealed. The switching element cannot be disconnected from the actuator any longer.

Best illumination level will be reached with Alu lens with window, Typ-Nr. 84-7215.x00 and 84-7211.x00.

Standard version:

Cable length 300 mm with insulated ferrule.

Other options on request:

Customisation of cable and connectors.

Contacts: NO = Normally open

Terminals: FR = Flat ribbon cable

Circuit drawing from page 43

## Switching element non-illuminated

	Protection degree	Contacts	Terminals	Typ-Nr.	Circuit drawing	
<b>Switching element non-illuminated</b>	IP 40	1 NO	FR	<b>84-8510.0040</b>	6	0.010
			PT 2.8 s	<b>84-8510.0020</b>	6	0.005



Standard version:

Cable length 300 mm with insulated ferrule; Plug-in terminal 2.8 x 0.8 mm (solderable).

Other options on request:

Customisation of cable and connectors; Rear side fully sealed (IP 67).

Protection degree (rear side):

IP 40, upgrade to IP 67 with plug typ-Nr. 84-900 possible; With applications where strong vibrations occur, the plugs may become loose.

Contacts: NO = Normally open

Terminals: FR = Flat ribbon cable, PT 2.8 s = Plug-in terminal 2.8 mm (solderable)

Circuit drawing from page 43

## Switching element PCB mounting illuminative

The customer has to decide what series resistor shall be used to the LED

	Contacts	Terminals	Typ-Nr.	Component layout	Technical drawing	Circuit drawing	
<b>Switching element PCB mounting illuminative</b>	1 NO	P	<b>92-851.342</b>	4	15	14	0.001



Illumination and mounting flange to be ordered separately.

Contacts: NO = Normally open

Terminals: P = PCB terminal

Component layout from page 31, Technical drawing from page 35, Circuit drawing from page 43

## Illumination element PCB mounting

The customer has to decide what series resistor shall be used to the LED

	Terminals	Typ-Nr.	Component layout	Technical drawing	
<b>Illumination element PCB mounting</b>	P	<b>92-800.042</b>	3	9	0.001



Illumination and mounting flange to be ordered separately.

Terminals: P = PCB terminal

Component layout from page 31, Technical drawing from page 35

## Mounting flange

	Typ-Nr.	Technical drawing	
<b>Mounting flange</b> Ring illumination (illuminated multi-color bezel)	<b>84-960.0</b>	13	0.001
Standard version (non-illuminated)	<b>92-960.0</b>	10	0.001



Technical drawing from page 35

## Flat receptacle

	Typ-Nr.	
<b>Flat receptacle</b> 2.8 x 0.8 mm	<b>84-9420</b>	0.001



## Insulation sleeve

	Typ-Nr.	
<b>Insulation sleeve</b> for Flat receptacles 84-9420	<b>31-929</b>	0.001



## Plug

	Typ-Nr.	
<b>Plug</b>	<b>84-900</b>	0.001



for back protection IP67 of switching elements and illumination elements.  
Two plugs are necessary per element.

## Illumination

### Single-LED

The customer has to decide what series resistor shall be used to the LED

	Socket	Light colour	Operating voltage/-current	Typ-Nr.	
<b>Single-LED</b>	T1 Bi-Pin	blue	3.5 VDC, 20 mA	<b>10-2602.3206L</b>	0.001
		green	3.5 VDC, 20 mA	<b>10-2602.3205L</b>	0.001
		orange	2.1 VDC, 20 mA	<b>10-2602.3203L</b>	0.001
		red	2.1 VDC, 20 mA	<b>10-2602.3202L</b>	0.001
		white	3.5 VDC, 20 mA	<b>10-2602.3209L</b>	0.001
		yellow	2.2 VDC, 20 mA	<b>10-2602.3174D</b>	0.001



### Bi-colour LED

The customer has to decide what series resistor shall be used to the LED

	Socket	Light colour	Operating voltage/-current	Typ-Nr.	
<b>Bi-colour LED</b>	T1 Bi-Pin	red/green	1.9/3.5 VDC, 20 mA	<b>10-2603.320AL</b>	0.001
		yellow/green	2.0/3.2 VDC, 20 mA	<b>10-2603.320CL</b>	0.001



### Multi-LED

The customer has to decide what series resistor shall be used to the LED

	Socket	Light colour	Operating voltage/-current	Typ-Nr.	
<b>Multi-LED</b>	T1 Bi-Pin	yellow	12 VDC, 40 mA	<b>10-5609.3174D</b>	0.001





## Emergency-stop and Stop pushbutton

### Emergency-stop label

front panel thickness 3 mm max.

	Marking	Typ-Nr.	
<b>Emergency-stop label</b> 60 mm dia., yellow, Mounting hole size 22.5 mm dia.	ARRET D'URGENCE	<b>704.963.7</b>	0.011
	EMERGENCY STOP	<b>704.963.6</b>	0.011
	NOT AUS	<b>704.963.5</b>	0.011
	NOT HALT	<b>704.963.8</b>	0.011
90 mm dia., yellow, Mounting hole size 22.5 mm dia.	ARRET D'URGENCE	<b>704.963.2</b>	0.011
	EMERGENCY STOP	<b>704.963.1</b>	0.011
	NOT AUS	<b>704.963.0</b>	0.011
	NOT HALT	<b>704.963.3</b>	0.011



### Emergency-stop protective shroud

Front panel thickness 1 ... 3 mm

	Protective shroud	Marking	Typ-Nr.	Technical drawing	
<b>Emergency-stop protective shroud</b> 45 mm dia., IP 40, mounting hole 22.5 mm dia., with anti-twist device	Metal yellow RAL 1004	without	<b>84-909</b>	12	0.021
50 mm dia., IP 65, mounting hole 22.5 mm dia., with anti-twist device	Plastic yellow	EMERGENCY STOP	<b>84-902B</b>	14	0.006
		NOT - AUS	<b>84-902A</b>	14	0.006
		NOT - HALT	<b>84-902D</b>	14	0.006
		without	<b>84-902</b>	14	0.006



Please note: By using the protective shroud Typ-Nr. 84-909 the E-stop or Stop-Switch has to be mounted twisted by 180°. Consult the dimensional drawing therefore.  
Technical drawing from page 35

### Fixing nut

	Fixing nut	Typ-Nr.	
<b>Fixing nut</b> 28 mm dia., for limited-space applications	Plastic black	<b>84-905</b>	0.002
30 mm dia., standard delivery	Plastic black	<b>84-908</b>	0.002



## Emergency-stop enclosures

Bottom grey similar RAL 7035; cover lead-sealable, yellow similar RAL 1004

	Dimension	Typ-Nr.	Technical drawing	
<b>Emergency-stop enclosures</b> with mounting hole 22.5 mm dia., with anti-twist device	L 65 mm, W 65 mm, H 57 mm	<b>84-910</b>	11	0.099



Openings for cable gland M16 or M20.

Protection class IP 66.

Technical drawing from page 35

## Stop pushbutton enclosure

Grey similar RAL 7035; cover lead-sealable

	Dimension	Typ-Nr.	Technical drawing	
<b>Stop pushbutton enclosure</b> with mounting hole 1 x 22.5 mm dia., with anti-twist device	L 94 mm, W 94 mm, H 81 mm	<b>704.945.1</b>	2	0.211
with mounting hole 2 x 22.5 mm dia., with anti-twist device	L 130 mm, W 94 mm, H 81 mm	<b>704.945.2</b>	3	0.251
with mounting hole 3 x 22.5 mm dia., with anti-twist device	L 180 mm, W 94 mm, H 81 mm	<b>704.945.3</b>	4	0.313
with mounting hole 4 x 22.5 mm dia., with anti-twist device	L 180 mm, W 182 mm, H 110 mm	<b>704.945.4</b>	5	0.572
with mounting hole 6 x 22.5 mm dia., with anti-twist device	L 180 mm, W 182 mm, H 110 mm	<b>704.945.5</b>	6	0.568



Technical drawing from page 35

## Cable gland

	Typ-Nr.	
<b>Cable gland</b> M16, Plastic grey	<b>61-9481.6</b>	0.007
M20, Plastic grey	<b>704.945.6</b>	0.011



with traction relief; protection degree IP 68.

## Flat receptacle

	Typ-Nr.	
<b>Flat receptacle</b> 2.8 x 0.5 mm for Plug-in terminal	<b>31-946</b>	0.001



## Insulation sleeve

	Typ-Nr.	
<b>Insulation sleeve</b> for Flat receptacles 31-946	<b>31-929</b>	0.001



## Stop request pushbutton

### Housing, pole mounting 35 mm dia.

	Housing	Colour	Typ-Nr.	Technical drawing	
<b>Housing, pole mounting 35 mm dia.</b>	Plastic blue	RAL 5017 traffic blue	<b>84-9500.6A</b>	19	0.035
	Plastic grey	RAL 7016	<b>84-9500.8</b>	19	0.035
	Plastic yellow	RAL 1023	<b>84-9500.4</b>	19	0.035



Screws are not contained in the scope of supply.  
Technical drawing from page 35

### Housing, pole mounting 38 mm dia.

	Housing	Colour	Typ-Nr.	Technical drawing	
<b>Housing, pole mounting 38 mm dia.</b>	Plastic grey	RAL 7016	<b>84-9600.8</b>	20	0.030
	Plastic yellow	RAL 1023	<b>84-9600.4</b>	20	0.030



Screws are not contained in the scope of supply.  
Technical drawing from page 35

### Adaptor, reducing to 30 mm dia.

	Housing	Colour	Typ-Nr.	Technical drawing	
<b>Adaptor, reducing to 30 mm dia.</b> for housing, pole mounting 35 mm dia.	Plastic grey	RAL 7016	<b>84-9700.8</b>	23	0.024
	Plastic yellow	RAL 1023	<b>84-9700.4</b>	23	0.024



Technical drawing from page 35

## Adaptor, reducing to 25 mm dia.

	Housing	Colour	Typ-Nr.	Technical drawing	
<b>Adaptor, reducing to 25 mm dia.</b> for housing, pole mounting 35 mm dia.	Plastic grey	RAL 7016	<b>84-9300.8</b>	22	0.008
	Plastic yellow	RAL 1023	<b>84-9300.4</b>	22	0.008



Technical drawing from page 35

## Housing, wall mounting

	Housing	Colour	Typ-Nr.	Technical drawing	
<b>Housing, wall mounting</b>	Plastic grey	RAL 7016	<b>84-9800.8</b>	21	0.024
	Plastic yellow	RAL 1023	<b>84-9800.4</b>	21	0.024



Screws are not contained in the scope of supply.  
Technical drawing from page 35

## Assembling

### Lens remover

	Typ-Nr.	
<b>Lens remover</b>	<b>61-9730.0</b>	0.011



### Mounting tool

	Typ-Nr.	
<b>Mounting tool</b> for tightening or loosening of Emergency-stop and Stop-Switch fixing nut	<b>84-996</b>	0.014
for tightening or loosening of Fixing nut, Indicator and Pushbutton	<b>84-997</b>	0.027



### Dismantling tool

	Typ-Nr.	
<b>Dismantling tool</b> for actuator dismantling of switching- and illumination element and mounting flange	<b>84-998</b>	0.002



## Emergency-stop

### Switching system

The double-break switching system can be supplied for the following switching functions:

1 Normally closed, 2 Normally closed, 1 Normally closed + 1 Normally open.

The Normally closed contacts have forced opening according to EN IEC 60947-5-1

### Material

#### Connection cable

Polyvinylchloride (PVC), operating temperature up to +65 °C

#### Mushroom-head cap

Polybutylenterephthalate (PBT), as per UL 94 V0 (red items)

#### Actuator housing

Polyamide (PA 66), as per UL 94 V0, Flat ribbon cable-cover  
Polyamide (PA 6.6), as per UL 94 V0

#### Material of contact

Silver alloy gold plated

### Mechanical characteristics

#### Front panel thickness

Standard 1 ... 4 mm  
with E-stop protective shroud Typ-Nr. 84-902 1 ... 3 mm

#### Mounting hole

22.5 mm dia. as per EN IEC 60947-5-1 with anti-twist device

#### Terminals

Soldering terminals 2.8 x 0.5 mm (solderable), CuSn6 tin-plated  
Flat ribbon cable 2-, 4-, or 6-poles 0.35 mm<sup>2</sup> (AWG 22)

#### Tightening torque

Fixing nut 80 Ncm

#### Actuating force

22 N ±4 N

#### Actuating travel

approx. 4 mm to release the internal operation part

#### Mechanical lifetime

≥50.000 cycles of operations

### Electrical characteristics

#### Standards

The devices comply with : EN IEC 60947-5-1, EN IEC 60947-5-5 (Emergency-stop), DIN EN ISO 13850, EN IEC 60204

#### Illumination

LED red with pole reversal, constant current source

Operation Voltage 5 VDC ... 30 VDC  
Current consumption 9.7 mA ... 12.4 mA

#### Rated Operational Voltage $U_e$

250 VAC, as per EN IEC 60947-1

#### Rated Insulation Voltage $U_i$

250 V, as per EN IEC 60947-1

#### Rated Impulse Withstand Voltage $U_{imp}$

2.5 kV, as per EN IEC 60947-1

#### Contact resistance

New state ≤ 50 mΩ, as per DIN IEC 60512-2-3

#### Isolation resistance

>10<sup>11</sup> Ω between the open contacts at 500 VDC, as per DIN IEC 60512-2-10

#### Electrical life

≥50 000 cycles of operations (inductive cosφ 0.4), as per EN IEC 60947-5-1

Voltage	120 VAC	240 VAC	125 VDC	250 VDC
Current	3 A	1.5 A	0.55 A	0.27 A

Reduced load ≥50'000 cycles of operations (resistive)

Voltage	1 VAC/DC	42 VAC/DC
Current	100 mA	200 mA

#### Conventional free air thermal current $I_{th}$

5 A, as per EN IEC 60947-5-1

the maximum current in continuous operation and at ambient temperature must not exceed the quoted maximum values.

#### Switch rating

Switch rating AC with silver contact (gold plated), service category AC-15, as per EN IEC 60947-5-1

Voltage	120 VAC	240 VAC
Current	3 A	1.5 A

Switch rating DC for silver contact (gold plated), service category DC-13, as per EN IEC 60947-5-1 (inductive)

Voltage	12 VDC	24 VDC	48 VDC	60 VDC	125 VDC	250 VDC
Current <sub>Plug</sub>	5 A	4 A	2.1 A	1.7 A	0.55 A	0.27 A
Current <sub>Cable</sub>	3 A	3 A	2.1 A	1.7 A	0.55 A	0.27 A

#### Recommended minimum operational data

Silver contacts (gold plated)

Voltage	1 VAC/DC
Current	1 mA

#### Electric strength

500 VAC, 50 Hz, 1 min, as per DIN IEC 60512-2

#### Rated conditional short-circuit current

1000 A, type of short-circuit unit 6 A gG, as per EN IEC 60947-5-1

#### Protection class

Class II, as per EN IEC 60947-5

#### Overvoltage category

II, as per EN IEC 60947-1

#### Degree of pollution

3, as per EN IEC 60947-1

### Environmental conditions

#### Storage temperature

-25 °C ... +80 °C

#### Operating temperature

-25 °C ... +65 °C

#### Front protection

IP 65, as per EN IEC 60529

## Shock resistance

(semi-sinusoidal)

max. 150 m/s<sup>2</sup>, pulse width 11 ms, 3-axis, as per EN IEC 60068-2-27

## Vibration resistance

(sinusoidal)

max. 50 m/s<sup>2</sup> at 10 Hz ... 500 Hz, 10 cycles, 3-axis, as per EN IEC 60068-2-6

## Climate resistance

Damp heat, cyclic

96 hours, +25 °C / 97 %, +55 °C / 93 % relative humidity, as per EN IEC 60068-2-30

Damp heat, steady

56 days, +40 °C / 93 % relative humidity, as per EN IEC 60068-2-78

Dry heat

96 hours, +70 °C, as per EN IEC 60068-2-2

Low temperature

96 hours, -40 °C, as per EN IEC 60068-2-1

Saline mist

96 Stunden, +35 °C in chemical solution NaCl, as per EN IEC 60068-2-11

## Approvals

### Approbations

SEV  
UL

### Declaration of conformity

CE

## Switching element illuminated pushbutton

## Switching system

Short-travel switching system with 2 independent contact points and tactile operation.

Guarantees reliable switching even of very light loads.

Fitted with 1 normally open contact.

## Material

### Connection cable

Polyvinylchloride (PVC), short-time heat-resistant up to 105 °C

### Material of contact

Silver alloy gold plated

### Switching element

Thermoplastic polyester (PET, PBT), as per UL 94 V0 and Polyacetale (POM), as per UL 94 HB

## Mechanical characteristics

### Terminals

Plug-in terminals 2.8 x 0.8 mm (solderable)

Flat ribbon cable 0.5 mm<sup>2</sup>

PCB terminal

### Actuating force

4.0 N ±0.2 N (measured at the lens)

### Actuating travel

~0.5 mm

## Rebound time

≤1 ms

## Resistance to heat of soldering

260 °C, 5 s (PCB assembly)

350 °C, 10 s (when using a soldering iron)

as per EN IEC 60068-2-20

## Mechanical lifetime

≥1 million cycles of operations

## Electrical characteristics

### Illumination

Single-Chip or Multi-Chip LED, green, orange, red, yellow, white and blue

Operation Voltage 12 VDC 24 VDC

Current consumption 40 mA 20 mA

### Contact resistance

Starting value (initial) ≤100 mΩ, as per DIN IEC 60512-2

### Isolation resistance

≥1 G Ω between all terminals at 100 VDC, as per DIN IEC 60512-2

### Electrical life

as per EN IEC 60512-5

5 million	cycles of operation	24 VAC, 50 mA at 480 Ω
5 million	cycles of operation	24 VAC, 100 mA at 240 Ω
2 million	cycles of operation	42 VAC, 50 mA at 840 Ω
2 million	cycles of operation	42 VAC, 100 mA at 420 Ω
300 000	cycles of operation	42 VAC, 100 mA at cosφ 0,4
250 000	cycles of operation	42 VAC, 200 mA at cosφ 0,395

1 million	cycles of operation	12 VDC, 250 mA at 48 Ω
1 million	cycles of operation	24 VDC, 50 mA at 480 Ω
1 million	cycles of operation	24 VDC, 100 mA at 240 Ω
5 million	cycles of operation	42 VDC, 25 mA at 1680 Ω
1.5 million	cycles of operation	42 VDC, 50 mA at 840 Ω
100 000	cycles of operation	42 VDC, 100 mA at 420 Ω

500 000	cycles of operation	24 VDC, 200 mA at L/R=30 ms
300 000	cycles of operation	42 VDC, 100 mA at L/R=30 ms
100 000	cycles of operation	42 VDC, 200 mA at L/R=30 ms

### Switch rating

Voltage 50 mVAC/DC ... 42 VAC/DC

Current 10 uA ... 100 mA

Power max. 2 W

### Electric strength

500 VAC, 50 Hz, 1 min, as per DIN IEC 60512-2

## Environmental conditions

### Storage temperature

-40 °C ... +85 °C

### Operating temperature

-25 °C ... +70 °C

### Protection degree

Back protection:

IP 40, standard version

IP 67, fully sealed version, with mounted actuator only.

**Shock resistance**

(semi-sinusoidal)

max. 100 m/s<sup>2</sup>, pulse width 11 ms, 3-axis, as per EN IEC 60068-2-27

**Vibration resistance**

(sinusoidal)

max. 50 m/s<sup>2</sup> at 10 Hz ... 500 Hz, 10 cycles, 3-axis, as per EN IEC 60068-2-6

## Actuator

### Material

**Lens**

Polycarbonate (PC), as per UL 94 V2 or Aluminium anodised

**Actuator housing**

Polyetherimid (PEI), as per UL 94 V0 or Aluminium anodised

### Mechanical characteristics

**Mounting hole**

22.5 mm dia. and 30.5 mm dia.

**Tightening torque**

Fixing nut max. 80 Ncm

**Actuating force**

4.0 N ±0.2 N (measured at the lens)

**Actuating travel**

Total switching travel 1.2 mm

**Mechanical lifetime**

≥1 million cycles of operations

### Electrical characteristics

**Electrostatic breakdown value**

Plastic case ≥15 kV

Aluminium case ≥5 kV

as per IEC 61000-4-2, mounted in plastic front panel

### Environmental conditions

**Storage temperature**

-40 °C ... +85 °C

**Operating temperature**

-25 °C ... +70 °C

**Front protection**

IP 67 and IP40, as per EN IEC 60529

**Climate resistance**

Damp heat, cyclic

96 hours, +25 °C / 97 %, +55 °C / 93 % relative humidity, as per EN IEC 60068-2-30

Damp heat, state

56 days, +40 °C / 93 % relative humidity, as per EN IEC 60068-2-78

Rapid change of temperature

100 cycles, -40 °C ... +80 °C, as per EN IEC 60068-2-14

## Suppressor circuits

When switching inductive loads such as relays, DC motors, and DC solenoids, it is always important to absorb surges (e.g. with a diode) to protect the contacts. When these inductive loads are switched off, a counter emf can severely damage switch contacts and greatly shorten lifetime.

Fig. 1 shows an inductive load with a free-wheeling diode connected in parallel. This free-wheeling diode provides a path for the inductor current to flow when the current is interrupted by the switch. Without this free-wheeling diode, the voltage across the coil will be limited only by dielectric breakdown voltages of the circuit or parasitic elements of the coil. This voltage can be kilovolts in amplitude even when nominal circuit voltages are low (e.g. 12 VDC) see Fig. 2.

The free-wheeling diode should be chosen so that the reverse breakdown voltage is greater than the voltage driving the inductive load. The DC blocking voltage (VR) of the free-wheeling diode can be found in the datasheet of a diode. The forward current should be equal or greater than the maximum current flowing through the load.

**To get an efficient protection, the free-wheeling diode must be connected as close as possible to the inductive load!**

Switching with inductive load  
Fig. 1



Counter emf  
over load without free-wheeling diode  
Fig. 2

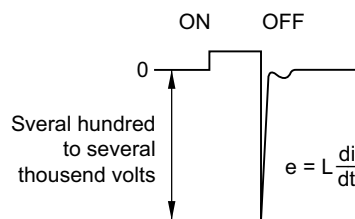



## Component layout

**1 Emergency-stop pushbutton, foolproof EN IEC 60947-5-5, complete page 7 | Stop pushbutton grey, complete page 8**

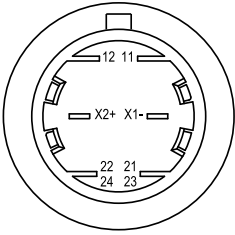

**2 Emergency-stop pushbutton, foolproof EN IEC 60947-5-5, complete page 7 | Stop pushbutton grey, complete page 8**

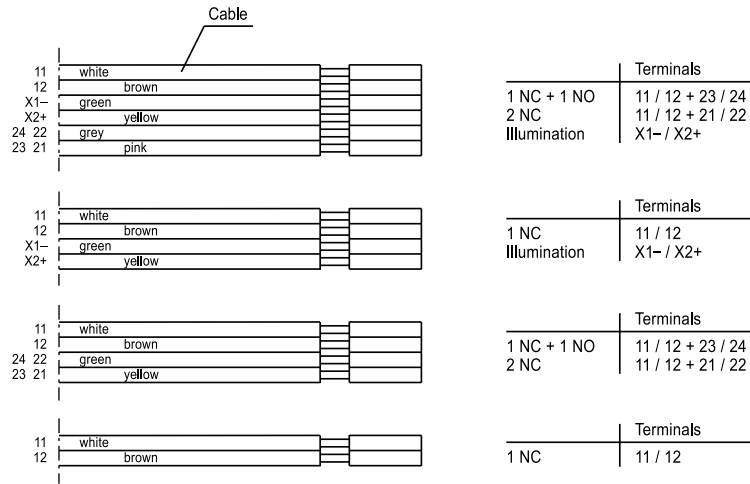
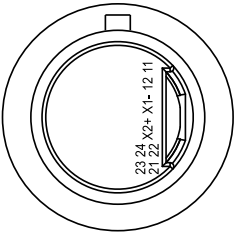

## 3 Illumination element PCB mounting page 21

### Single-LED

Drilling plan (Elementside)

- A Fixing holes for mounting flange (92-960.0)
- B Holes for LED
- C Holes for centering pins



### Bi-colour-LED

Drilling plan (Elementside)

- A Fixing holes for mounting flange (92-960.0)
- B Holes for Bi-colour LED:  
BA1 (green) + BA2 (yellow or red) = Anodes, BC = Cathode
- C Holes for centering pins



### Hyper mini SMD-LED

Drilling plan (Elementside)

- A Fixing holes for mounting flange (84-960.0)



Libraries for the PCB layout-system p-cad 200X see : [www.pcad.com/en/library](http://www.pcad.com/en/library) Third-party Libraries

## 4 Switching element PCB mounting illuminative page 21

### Single-LED

Drilling plan (Elementside)

- A Fixing holes for mounting flange (92-960.0)
- B Holes for LED
- C Holes for contact pins  
Pad max. Ø 2.5 mm  
Through-connection recommended



### Bi-colour-LED

Drilling plan (Elementside)

- A Fixing holes for mounting flange (92-960.0)
- B Holes for Bi-colour LED:  
BA1 (green) + BA2 (yellow or red) = Anodes, BK = Cathode
- C Holes for contact pins  
Pad max. Ø 2.5 mm  
Through-connection recommended



### Hyper mini SMD-LED

Drilling plan (Elementside)

- A Fixing holes for mounting flange (84-960.0)



Libraries for the PCB layout-system p-cad 200X see : [www.pcad.com/en/library](http://www.pcad.com/en/library) Third-party Libraries

## Mounting dimensions

1 Indicator actuator page 9 | Illuminated pushbutton actuator page 9 | Pushbutton actuator page 10 | Indicator actuator with ring illumination (illuminated bezel) page 10 | Pushbutton actuator with ring illumination (illuminated bezel) page 11 | Indicator actuator with ring illumination (illuminated multi-colour bezel) page 11 | Pushbutton actuator with ring illumination (illuminated multi-colour bezel) page 12



Hole spacing 31 mm min. by using blind plug 704.960.4

2 Emergency-stop pushbutton, foolproof EN IEC 60947-5-5, complete page 7 | Stop pushbutton grey, complete page 8



3 Illuminated pushbutton actuator page 9 | Pushbutton actuator page 10



## Technical drawing

### 1 Blind plug page 16



### 2 Stop pushbutton enclosure page 24



### 3 Stop pushbutton enclosure page 24



4 Stop pushbutton enclosure page 24



5 Stop pushbutton enclosure page 24



## 6 Stop pushbutton enclosure page 24



## 7 Legend frame page 15



## 8 Blind plug page 16



With this print version of the series 84, the panel thickness is reduced to 2.5 mm max.

## 9 Illumination element PCB mounting page 21



## 10 Mounting flange page 21



## 11 Emergency-stop enclosures page 24



## 12 Emergency-stop protective shroud page 23





13 Mounting flange page 21



14 Emergency-stop protective shroud page 23



15 Switching element PCB mounting illuminative page 21



16 Indicator actuator page 9 | Illuminated pushbutton actuator page 9 | Pushbutton actuator page 10 | Indicator actuator with ring illumination (illuminated bezel) page 10 | Pushbutton actuator with ring illumination (illuminated bezel) page 11 | Indicator actuator with ring illumination (illuminated multi-colour bezel) page 11 | Pushbutton actuator with ring illumination (illuminated multi-colour bezel) page 12

## Lenses



17 Emergency-stop pushbutton, foolproof EN IEC 60947-5-5, complete page 7 | Stop pushbutton grey, complete page 8



## 18 Illuminated pushbutton actuator page 9 | Pushbutton actuator page 10



## 19 Housing, pole mounting 35 mm dia. page 25



Please note: The cut-out of the pole must read min. 22 mm dia. and needs to be aligned with the switch!

20 Housing, pole mounting 38 mm dia. page 25



Please note: The cut-out of the pole must read min. 22 mm dia. and needs to be aligned with the switch!

21 Housing, wall mounting page 26



Please note: The cut-out of the wall must read min. 22 mm dia. and needs to be aligned with the switch!

22 Adaptor, reducing to 25 mm dia. page 26



23 Adaptor, reducing to 30 mm dia. page 25



## Circuit drawing

### 1 Illumination element with Bi-colour illumination page 18



### 2 Illumination element with Bi-colour illumination page 18



### 3 Switching element with Bi-colour illumination page 20



### 4 Illuminated pushbutton actuator page 9 | Pushbutton actuator page 10 | Pushbutton actuator with ring illumination (illuminated bezel) page 11 | Pushbutton actuator with ring illumination (illuminated multi-colour bezel) page 12



### 5 Illumination element page 17



### 6 Switching element non-illuminated page 20



### 7 Switching element illuminated page 19

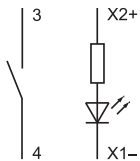

### 8 Emergency-stop pushbutton, foolproof EN IEC 60947-5-5, complete page 7 | Stop pushbutton grey, complete page 8



**9 Emergency-stop pushbutton, foolproof EN IEC 60947-5-5, complete page 7 | Stop pushbutton grey, complete page 8**



**10 Emergency-stop pushbutton, foolproof EN IEC 60947-5-5, complete page 7 | Stop pushbutton grey, complete page 8**



**11 Emergency-stop pushbutton, foolproof EN IEC 60947-5-5, complete page 7 | Stop pushbutton grey, complete page 8**



**12 Emergency-stop pushbutton, foolproof EN IEC 60947-5-5, complete page 7 | Stop pushbutton grey, complete page 8**



**13 Emergency-stop pushbutton, foolproof EN IEC 60947-5-5, complete page 7 | Stop pushbutton grey, complete page 8**



**14 Switching element PCB mounting illuminative page 21**



# Index from Typ-Nr.

Typ-Nr.	Page	Typ-Nr.	Page	Typ-Nr.	Page
10-2602.3174D	22	84-5030.0020	7	84-7124.400A	15
10-2602.3202L	22	84-5030.0040	7	84-7124.500A	15
10-2602.3203L	22	84-5031.2B20	7	84-7124.600A	15
10-2602.3205L	22	84-5031.2B40	7	84-7125.000	13
10-2602.3206L	22	84-5040.0020	7	84-7125.800	13
10-2602.3209L	22	84-5040.0040	7	84-7201.000	14
10-2603.320AL	22	84-5041.2B20	7	84-7201.200	14
10-2603.320CL	22	84-5041.2B40	7	84-7201.400	14
10-5609.3174D	22	84-5120.0020	7	84-7201.500	14
31-929	22	84-5120.0040	7	84-7201.600	14
31-929	25	84-5121.2B20	7	84-7201.800	14
31-946	24	84-5121.2B40	7	84-7202.000	14
61-9453.0	16	84-5130.0020	7	84-7202.000A	14
61-9481.6	24	84-5130.0040	7	84-7202.200	14
61-9707.7	13	84-5131.2B20	7	84-7202.200A	14
61-9730.0	26	84-5131.2B40	7	84-7202.400	14
61-9980.0	15	84-5140.0020	7	84-7202.400A	14
704.945.1	24	84-5140.0040	7	84-7202.500	14
704.945.2	24	84-5141.2B20	7	84-7202.500B	14
704.945.3	24	84-5141.2B40	7	84-7202.600	14
704.945.4	24	84-6820.0020	8	84-7202.600A	14
704.945.5	24	84-6820.0040	8	84-7202.800	14
704.945.6	24	84-6821.2B20	8	84-7202.800A	14
704.963.0	23	84-6821.2B40	8	84-7205.000	14
704.963.1	23	84-6830.0020	8	84-7205.000A	14
704.963.2	23	84-6830.0040	8	84-7205.200	14
704.963.3	23	84-6831.2B20	8	84-7205.200A	14
704.963.5	23	84-6831.2B40	8	84-7205.400	14
704.963.6	23	84-6840.0020	8	84-7205.400A	14
704.963.7	23	84-6840.0040	8	84-7205.500	14
704.963.8	23	84-6841.2B20	8	84-7205.500A	14
704.964.8	16	84-6841.2B40	8	84-7205.600	14
704.968.0	16	84-7111.200	13	84-7205.600A	14
704.968.1	16	84-7111.201	13	84-7205.800	14
84-0080.7	11	84-7111.202	13	84-7205.800A	14
84-0090.7	10	84-7111.203	13	84-7211.000	15
84-0100.0	9	84-7111.300	13	84-7211.200	15
84-0200.7	9	84-7111.301	13	84-7211.400	15
84-1081.7	12	84-7111.400	13	84-7211.500	15
84-1091.7	11	84-7111.401	13	84-7211.600	15
84-1101.0	10	84-7111.500	13	84-7211.800	15
84-1101.0	9	84-7111.501	13	84-7215.000	15
84-1201.0	10	84-7111.502	13	84-7215.200	15
84-1201.0	9	84-7111.503	13	84-7215.400	15
84-1201.2	10	84-7111.600	13	84-7215.500	15
84-1201.2	9	84-7111.601	13	84-7215.600	15
84-1201.4	10	84-7111.602	13	84-7215.800	15
84-1201.4	9	84-7111.603	13	84-8001.2320	17
84-1201.5	10	84-7111.700	13	84-8001.2340	17
84-1201.5	9	84-7111.701	13	84-8001.2620	17
84-1201.6	10	84-7111.702	13	84-8001.2640	17
84-1201.6	9	84-7111.703	13	84-8001.3320	17
84-1201.7	10	84-7114.600A	15	84-8001.3340	17
84-1201.7	9	84-7115.200	13	84-8001.3620	17
84-1221.7	10	84-7115.300	13	84-8001.3640	17
84-1221.7	9	84-7115.400	13	84-8001.4320	17
84-2101.0	10	84-7115.500	13	84-8001.4340	17
84-2101.0	9	84-7115.600	13	84-8001.4620	17
84-3100.0	9	84-7115.700	13	84-8001.4640	17
84-5020.0020	7	84-7121.000	13	84-8001.5320	17
84-5020.0040	7	84-7121.800	13	84-8001.5340	17
84-5021.2B20	7	84-7124.000A	15	84-8001.5620	17
84-5021.2B40	7	84-7124.200A	15	84-8001.5640	17

# Index from Typ-Nr.

Typ-Nr.	Page	Typ-Nr.	Page	Typ-Nr.	Page
84-8001.6320	17	84-996	26		
84-8001.6340	17	84-997	26		
84-8001.6620	17	84-998	26		
84-8001.6640	17	92-800.042	21		
84-8001.9320	17	92-851.342	21		
84-8001.9340	17	92-960.0	21		
84-8001.9620	17				
84-8001.9640	17				
84-8005.7620	18				
84-8005.7640	18				
84-8005.8620	18				
84-8005.8640	18				
84-8510.0020	20				
84-8510.0040	20				
84-8511.2320	19				
84-8511.2340	19				
84-8511.2620	19				
84-8511.2640	19				
84-8511.3320	19				
84-8511.3340	19				
84-8511.3620	19				
84-8511.3640	19				
84-8511.4320	19				
84-8511.4340	19				
84-8511.4620	19				
84-8511.4640	19				
84-8511.5320	19				
84-8511.5340	19				
84-8511.5620	19				
84-8511.5640	19				
84-8511.6320	19				
84-8511.6340	19				
84-8511.6620	19				
84-8511.6640	19				
84-8511.9320	19				
84-8511.9340	19				
84-8511.9620	19				
84-8511.9640	19				
84-8515.7640	20				
84-8515.8640	20				
84-900	22				
84-902	23				
84-902A	23				
84-902B	23				
84-902D	23				
84-905	23				
84-908	23				
84-909	23				
84-910	24				
84-9103.7	15				
84-9300.4	26				
84-9300.8	26				
84-9420	21				
84-9500.4	25				
84-9500.6A	25				
84-9500.8	25				
84-960.0	21				
84-9600.4	25				
84-9600.8	25				
84-9700.4	25				
84-9700.8	25				
84-9800.4	26				
84-9800.8	26				





	<b>EAO AG</b>
	Tannwaldstrasse 88 4601 Olten, Switzerland
<b>E-mail</b>	info@eao.com
<b>Website</b>	www.eao.com
	<b>Austria</b>
Phone	+49 201 85 87 0
Fax	+49 201 85 87 210
E-mail	sales.ede@eao.com
	<b>Belgium</b>
Phone	+32 3 777 82 36
Fax	+32 3 777 84 19
E-mail	sales.ebl@eao.com
	<b>China</b>
Phone	+852 27 86 91 41
Fax	+852 27 86 95 61
E-mail	sales.ehk@eao.com
	<b>France</b>
Phone	+33 1 64 43 37 37
Fax	+33 1 64 43 37 49
E-mail	sales.esa@eao.com
	<b>Germany</b>
Phone	+49 201 85 87 0
Fax	+49 201 85 87 210
E-mail	sales.ede@eao.com
	<b>Italy</b>
Phone	+39 035 481 0189
Fax	+39 035 481 3786
E-mail	sales.eit@eao.com
	<b>Japan</b>
Phone	+81 3 5444 5411
Fax	+81 3 5444 0345
E-mail	sales.esj@eao.com
	<b>Netherlands</b>
Phone	+31 78 653 17 00
Fax	+31 78 653 17 99
E-mail	sales.enl@eao.com
	<b>Sweden</b>
Phone	+46 8 683 86 60
Fax	+46 8 724 29 12
E-mail	sales.esw@eao.com
	<b>Switzerland</b>
Phone	+41 62 388 95 00
Fax	+41 62 388 95 55
E-mail	sales.ech@eao.com
	<b>United Kingdom</b>
Phone	+44 1444 236 000
Fax	+44 1444 236 641
E-mail	sales.euk@eao.com
	<b>USA</b>
Phone	+1 203 877 4577
Fax	+1 203 877 3694
E-mail	sales.eus@eao.com
	<b>Other Countries</b>
Phone	+41 62 286 92 10
Fax	+41 62 296 21 62
E-mail	info@eao.com

## Данный компонент на территории Российской Федерации

### Вы можете приобрести в компании MosChip.

Для оперативного оформления запроса Вам необходимо перейти по данной ссылке:

<http://moschip.ru/get-element>

Вы можете разместить у нас заказ для любого Вашего проекта, будь то серийное производство или разработка единичного прибора.

В нашем ассортименте представлены ведущие мировые производители активных и пассивных электронных компонентов.

Нашей специализацией является поставка электронной компонентной базы двойного назначения, продукции таких производителей как XILINX, Intel (ex.ALTERA), Vicor, Microchip, Texas Instruments, Analog Devices, Mini-Circuits, Amphenol, Glenair.

Сотрудничество с глобальными дистрибьюторами электронных компонентов, предоставляет возможность заказывать и получать с международных складов практически любой перечень компонентов в оптимальные для Вас сроки.

На всех этапах разработки и производства наши партнеры могут получить квалифицированную поддержку опытных инженеров.

Система менеджмента качества компании отвечает требованиям в соответствии с ГОСТ Р ИСО 9001, ГОСТ РВ 0015-002 и ЭС РД 009

### Офис по работе с юридическими лицами:

105318, г.Москва, ул.Щербаковская д.3, офис 1107, 1118, ДЦ «Щербаковский»

Телефон: +7 495 668-12-70 (многоканальный)

Факс: +7 495 668-12-70 (доб.304)

E-mail: [info@moschip.ru](mailto:info@moschip.ru)

Skype отдела продаж:

moschip.ru

moschip.ru\_4

moschip.ru\_6

moschip.ru\_9