



### Features

- 2" x 4" x 1.3" Package
- For 1U Applications
- 175W w/air, 120W convection cooled
- Universal Input 90-264Vac
- Average Efficiency meets Level V Requirements
- Approved to CSA/EN/IEC/UL60950, 2nd Edition
- 12V fan output
- Efficiency 90% typical at Full Load
- 3 Year Warranty
- RoHS Compliant



### Description

A highly dense 175Watts AC to DC power supply designed for industrial and ITE applications. With convection rating of 120 Watts, CINT1175 family leads the market in power density and low leakage makes it a perfect solution for lighting applications. With input & output monitoring alarms plus isolated 12V/0.4A fan, it is one the most feature rich supplies and can easily fit in 1U chassis. All 5 models are CE marked to low voltage directive and approved to ITE standards of EN60950, 2nd edition.

### Model Selection

| Model Number     | Volts | Output Current |            | Fan Output | Ripple & Noise**    | Total Regulation | OVP*** Threshold*** |
|------------------|-------|----------------|------------|------------|---------------------|------------------|---------------------|
|                  |       | w/200LFM air   | Convection |            |                     |                  |                     |
| CINT1175A1206K01 | 12V   | 14.6A          | 11.7A      | 12Vdc/0.4A | 0.5%RMS, 1.2% pk-pk | ±3%              | 14.0 ± 1.1V         |
| CINT1175A1506K01 | 15V   | 11.7A          | 9.3A       | 12Vdc/0.4A | 0.5%RMS, 1.0% pk-pk | ±3%              | 18.5 ± 1.5V         |
| CINT1175A2406K01 | 24V   | 7.3A           | 5.8A       | 12Vdc/0.4A | 0.5%RMS, 1.2% pk-pk | ±3%              | 28.0 ± 2.5V         |
| CINT1175A4806K01 | 48V   | 3.6A           | 2.9A       | 12Vdc/0.4A | 0.5%RMS, 1.0% pk-pk | ±3%              | 55.0 ± 4.0V         |
| CINT1175A5606K01 | 56V   | 3.1A           | 2.5A       | 12Vdc/0.4A | 0.5%RMS, 1.0% pk-pk | ±3%              | 59.0 ± 1.0V         |

Notes: \* Total convection power is 120 Watts.

\*\* Measured with noise probe directly across output terminals, and load terminated with 0.1µF ceramic and 10µF low ESR capacitors.

\*\*\* Output adjustment on 56V model will not exceed 56.2 volts.

### General Specifications

|                       |                                             |                     |                                                                                               |
|-----------------------|---------------------------------------------|---------------------|-----------------------------------------------------------------------------------------------|
| <b>AC Input</b>       | 100-240Vac, ±10%, 47-63Hz, 1Ø<br>120-370Vdc | <b>Turn On Time</b> | Less than 2 sec. @115Vac (inversely proportional to input voltage and thermistor temperature) |
| <b>Input Current</b>  | 115Vac: 2A, 230Vac: 1A                      | <b>Hold-up Time</b> | 16mS, typical                                                                                 |
| <b>Inrush Current</b> | 264Vac, cold start: will not exceed 50A     | <b>Signals</b>      | AC Power Fail, DC OK                                                                          |

## General Specifications (continued)

|                              |                                                                                                                                          |                                 |                                                                                                                              |
|------------------------------|------------------------------------------------------------------------------------------------------------------------------------------|---------------------------------|------------------------------------------------------------------------------------------------------------------------------|
| <b>Input Fuses</b>           | F1, F2: 4A, 250Vac fuses provided on all models                                                                                          | <b>Overload Protection</b>      | Hiccup Mode                                                                                                                  |
| <b>Earth Leakage Current</b> | <750 $\mu$ A@264Vac, 60Hz, NC                                                                                                            | <b>Short Circuit Protection</b> | Provided - no damage will occur if the output is shorted.                                                                    |
| <b>Efficiency</b>            | 90% typical at 115Vac                                                                                                                    | <b>Overvoltage Protection</b>   | OVP firing reduces output voltage to <50% of nominal in <50ms. See chart for trip range.                                     |
| <b>Output Power</b>          | 175W continuous, with 200 lfm airflow, 120W convection cooled – See chart for specific voltage model ratings.                            | <b>Switching Frequency</b>      | PFC: Fixed, 65kHz<br>Main Converter: Variable 35-200kHz, 65-70kHz at full load.                                              |
| <b>Transient Response</b>    | 50% load step. $\Delta i/\Delta t$ : <0.2A/ $\mu$ S<br>Max Volt Deviation = 3%                                                           | <b>Isolation</b>                | Input-Output: 4000Vac<br>Input-Ground: 1800Vac<br>Output-Ground: 1500Vac                                                     |
| <b>Ripple and Noise</b>      | See chart                                                                                                                                | <b>Operating Temperature</b>    | -10°C to +70°C<br>Start Up at -40°C, full load                                                                               |
| <b>Output Voltage</b>        | See chart                                                                                                                                | <b>Temperature Derating</b>     | Derate output power linearly above 50°C to 50% at 70°C                                                                       |
| <b>Voltage Adjustability</b> | +/-5% from nominal                                                                                                                       | <b>Storage Temperature</b>      | -40°C to +85°C                                                                                                               |
| <b>Minimum Load</b>          | Not required                                                                                                                             | <b>Altitude</b>                 | Operating: -500 to 10,000 ft.<br>Non-operating: -500 to 40,000 ft.                                                           |
| <b>Total Regulation</b>      | +/- 3%. See chart                                                                                                                        | <b>Relative Humidity</b>        | 5% to 95%, non-condensing                                                                                                    |
| <b>Vibration</b>             | Operating: 0.003g/Hz, 1.5grms overall, 3 axes, 10 min/axis<br>Non-Operating: 0.026g <sup>2</sup> /Hz, 5.0grms overall, 3 axes, 1 hr/axis | <b>Shock</b>                    | Operating: Half-sine, 20gpk, 10ms, 3 axes, 6 shocks total<br>Non-Operating: Half-sine, 40 gpk, 10 ms, 3 axes, 6 shocks total |
| <b>Dimensions</b>            | W: 2.0" x L: 4.0" x H: 1.3"                                                                                                              | <b>Safety Standards</b>         | EN/CSA/UL/IEC 60950-1, 2nd Edition                                                                                           |
| <b>Weight</b>                | 210g                                                                                                                                     | <b>MTBF</b>                     | 331,105 hours, 175W load, 110Vac input, 25°C ambient                                                                         |

## Auxiliary Signals

|                       |                                                                                                                  |               |                                                                                                      |
|-----------------------|------------------------------------------------------------------------------------------------------------------|---------------|------------------------------------------------------------------------------------------------------|
| <b>AC Power Fail:</b> | During normal operations, stays HIGH. Signal goes LOW with 5mS warning before loss of DC output from AC failure. | <b>DC OK:</b> | Open collector logic signal goes and stays HIGH 100mS to 500mS after main output reaches regulation. |
| <b>Inhibit:</b>       | Connect to inhibit pin to output common to inhibit the DC output.                                                |               |                                                                                                      |

### EMI / EMC Compliance

|                                         |                                                                                   |
|-----------------------------------------|-----------------------------------------------------------------------------------|
| Conducted Emissions                     | EN55011/22 Class B, FCC Part 15, Subpart B, Class B                               |
| Radiated Emissions                      | EN55011/22 Class A, FCC Part 15, Subpart B, Class A w/6db margin                  |
| Static Discharge Immunity               | EN61000-4-2, Criteria A, 6kV Contact Discharge, 8kV air discharge                 |
| Radiated RF Immunity                    | EN61000-4-3, 3V/m. Criteria A                                                     |
| EFT/Burst Immunity                      | EN61000-4-4, 2kV/5kHz, Criteria A                                                 |
| Line Surge Immunity                     | EN61000-4-5, 1kV differential, 2kV common-mode, Criteria A                        |
| Conducted RF Immunity                   | EN61000-4-6, 3Vrms, Criteria A                                                    |
| Power Frequency Magnetic Field Immunity | EN61000-4-8, 3A/m, Criteria A                                                     |
| Voltage Dip Immunity                    | EN61000-4-11, 0% Vin, 0.5cycle; 40% Vin, 5 cycles; 70% Vin, 25 cycles; Criteria A |
| Line Harmonic Emissions                 | EN61000-3-2, Class A, B, C, & D                                                   |
| Flicker Test                            | EN61000-3-3, Complies (dmax<6%)                                                   |

### Mechanical Drawing

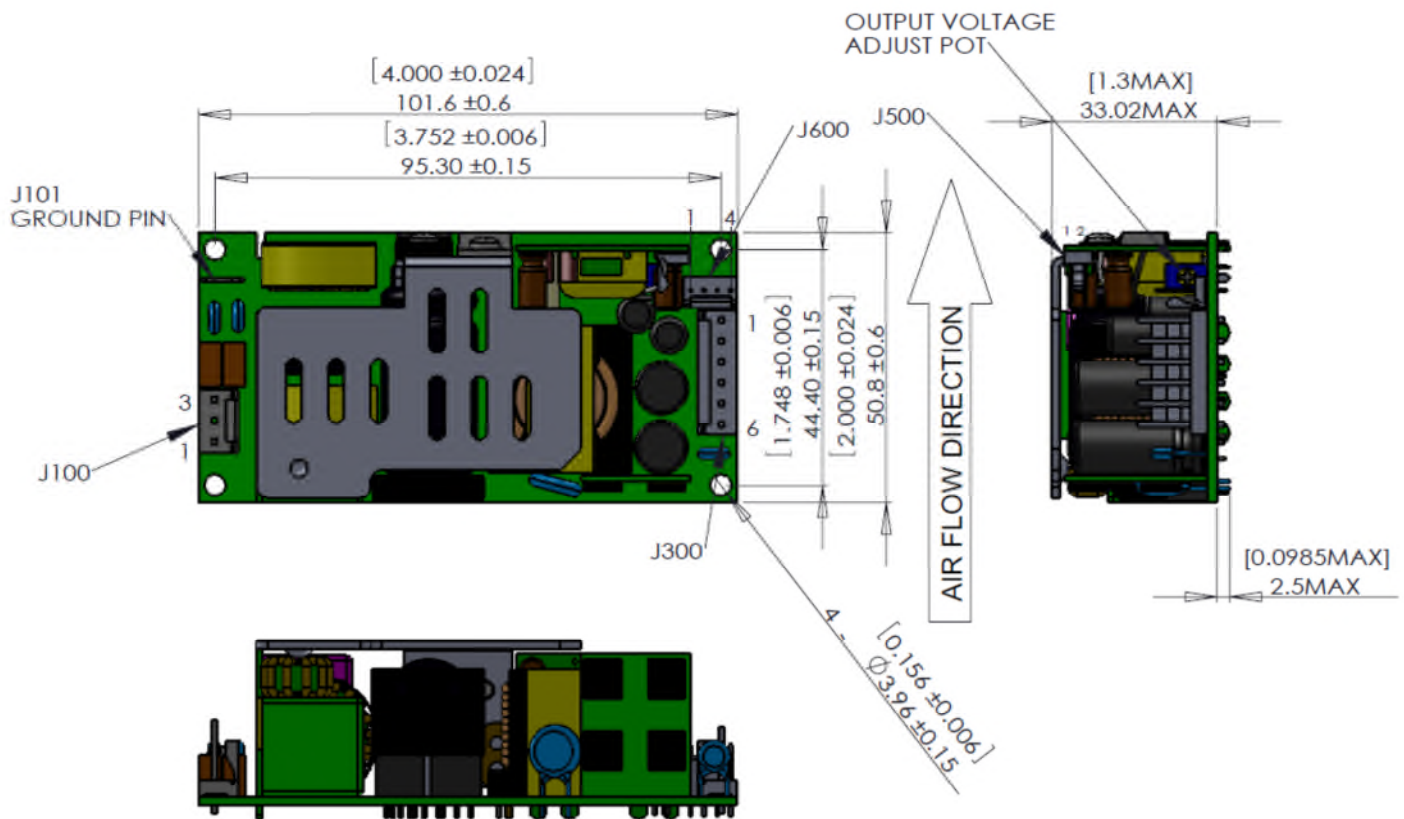

## Connector Information

| Input Connector J100                                      | Ground J101                            | DC Output Connector J300                                                            | Fan Output Connector J500                              | Signal Connector J600                                  |
|-----------------------------------------------------------|----------------------------------------|-------------------------------------------------------------------------------------|--------------------------------------------------------|--------------------------------------------------------|
| PIN 1) AC LINE<br>PIN 2) EMPTY<br>PIN 3) AC NEUTRAL       | 0.25" FASTON TAB                       | PIN 1) +Vout PIN 4) -Vout<br>PIN 2) +Vout PIN 5) -Vout<br>PIN 3) +Vout PIN 6) -Vout | PIN 1) +12Vfan<br>PIN 2) RTN                           | PIN 1) Inhibit<br>PIN 2) PF/DC OK<br>PIN 3, 4) Common  |
| Mating Connector:<br>Molex 09-50-3031<br>Pins= 08-52-0072 | Mating Connector:<br>Molex 01-90020009 | Mating Connector:<br>AMP 640250-6<br>Pins = 640252-1                                | Mating Connector:<br>Molex 1375820-2<br>Pins = 1375819 | Mating Connector:<br>Molex 1375820-4<br>Pins = 1375819 |

## Fan Output – J500

J500 provides a 12V@0.4mA output to support a system cooling fan. The fan output is always available when AC input is present, so it also can be used for a 12V standby output is so desired.

## AC Power Failure/DC OK and Inhibit Signals – J600

### AC Power Failure/DC OK

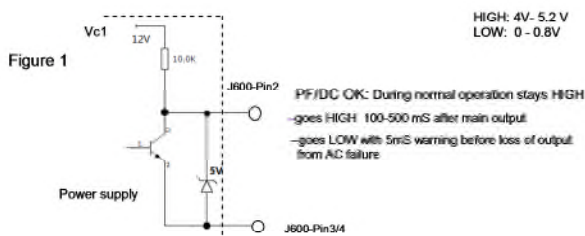

AC Power failure and DC OK signals use the same pin ,so the signals can be used as follows:

DC OK: Pin2 = HIGH & Pin1 = HIGH      AC Power Failure: Pin2 = LOW & Pin1 = LOW

### Inhibit

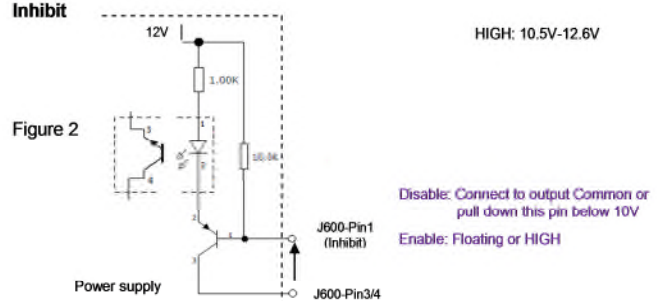

## Timing Sequence

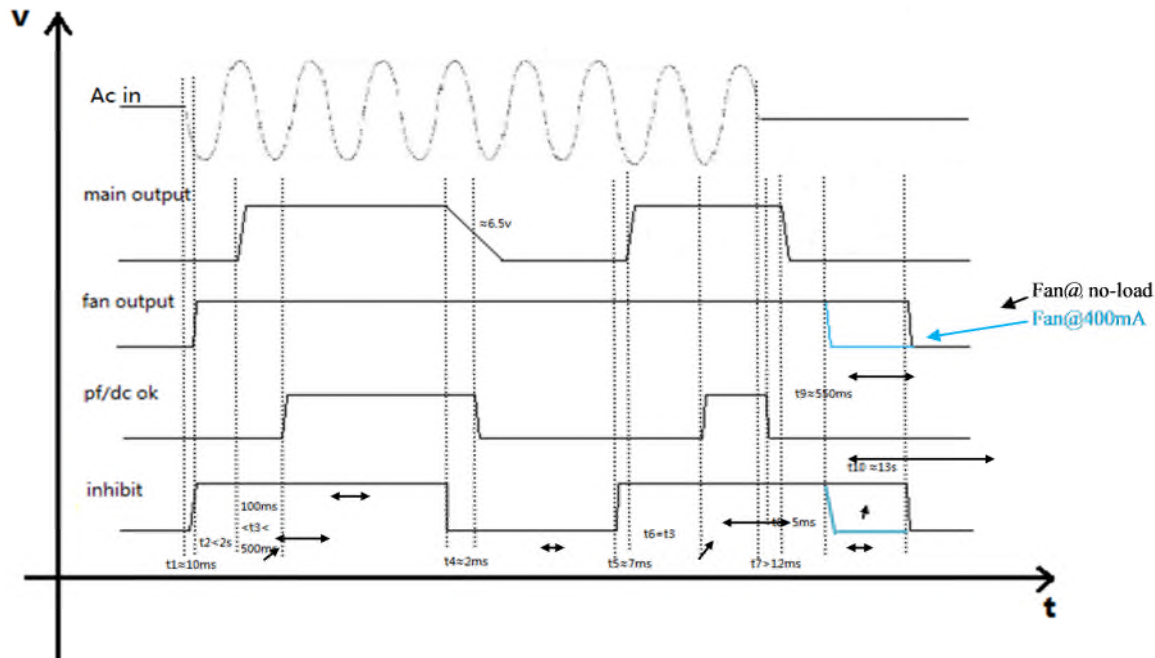

## Isolation Specifications

| Parameter                      | Conditions/Description                        | Min                        | Nom | Max | Units             |
|--------------------------------|-----------------------------------------------|----------------------------|-----|-----|-------------------|
| Insulation Safety Rating       | Input/Ground<br>Input/Output<br>Output/Ground | Basic<br>Reinforced<br>n/a |     |     |                   |
| Electric Strength Test Voltage | Input/Ground<br>Input/Output<br>Output/Ground | 1800<br>4000<br>1500       | -   | -   | Vac<br>Vac<br>Vac |

## Input Specifications

All specifications apply over specified input voltage, output load, and temperature range, unless otherwise noted.

| Parameter                 | Conditions/Description                                                                                                       | Min | Nom     | Max | Units |
|---------------------------|------------------------------------------------------------------------------------------------------------------------------|-----|---------|-----|-------|
| Input Voltage             |                                                                                                                              | 90  | 115/230 | 264 | Vac   |
| Turn-On Input Voltage     | Ramping up                                                                                                                   |     | 82.7    |     | Vac   |
| Turn-Off Input Voltage    | Ramping down                                                                                                                 |     | 67.0    |     | Vac   |
| Input Frequency           |                                                                                                                              | 47  | 50/60   | 63  | Hz    |
| Inrush Current Limitation | 264Vac, cold start                                                                                                           | -   | -       | 50  | A     |
| Power Factor              | $V_{i\ nom}, I_{o\ nom}$                                                                                                     | 0.9 | -       | -   |       |
| Efficiency                | $V_{i\ nom}, I_{o\ nom}$<br>CINT1175A1206K01<br>CINT1175A1506K01<br>CINT1175A2406K01<br>CINT1175A4806K01<br>CINT1175A5606K01 | -   | 90%     | -   | %     |

## Output Specifications

| Parameter                                            | Conditions/Description                                    | Min    | Nom       | Max         | Units          |
|------------------------------------------------------|-----------------------------------------------------------|--------|-----------|-------------|----------------|
| Output Voltage Setpoint Accuracy<br>CINT1175A1206K01 | $V_{i\ nom}, I_{o1}$ @ ADC, $TC = 25\ ^\circ C$           | -3     | -         | 3           | % $V_{o\ nom}$ |
| Output Voltage Setpoint Accuracy<br>CINT1175A1506K01 | $V_{i\ nom}, I_{o1}$ @ ADC, $TC = 25\ ^\circ C$           | -3     | -         | 3           | % $V_{o\ nom}$ |
| Output Voltage Setpoint Accuracy<br>CINT1175A2406K01 | $V_{i\ nom}, I_{o1}$ @ ADC, $TC = 25\ ^\circ C$           | -3     | -         | 3           | % $V_{o\ nom}$ |
| Output Voltage Setpoint Accuracy<br>CINT1175A4806K01 | $V_{i\ nom}, I_{o1}$ @ ADC, $TC = 25\ ^\circ C$           | -3     | -         | 3           | % $V_{o\ nom}$ |
| Output Voltage Setpoint Accuracy<br>CINT1175A5606K01 | $V_{i\ nom}, I_{o1}$ @ ADC, $TC = 25\ ^\circ C$           | -3     | -         | 3           | % $V_{o\ nom}$ |
| Output Current V1<br>Output Current V2               | CINT1175A1206K01                                          | 0<br>0 | 10.0<br>- | 14.6<br>0.4 | ADC<br>ADC     |
| Output Current V1<br>Output Current V2               | CINT1175A1506K01                                          | 0<br>0 | 8.0<br>-  | 11.7<br>0.4 | ADC<br>ADC     |
| Output Current V1<br>Output Current V2               | CINT1175A2406K01                                          | 0<br>0 | 5.0<br>-  | 7.3<br>0.4  | ADC<br>ADC     |
| Output Current V1<br>Output Current V2               | CINT1175A4806K01                                          | 0<br>0 | 2.5<br>-  | 3.6<br>0.4  | ADC<br>ADC     |
| Output Current V1<br>Output Current V2               | CINT1175A5606K01                                          | 0<br>0 | 2.1<br>-  | 3.1<br>0.4  | ADC<br>ADC     |
| Static Line Regulation V1                            | $V_{i\ min} - V_{i\ max}, V_{i\ nom}, 0-100\% I_{o\ nom}$ | -1     | -         | 1           | % $V_{o\ nom}$ |
| Static Load Regulation V1<br>(Droop Characteristic)  | $V_{i\ min} - V_{i\ max}, V_{i\ nom}, 0-100\% I_{o\ nom}$ | -3     | -         | 3           | % $V_{o\ nom}$ |

**Output Specifications (continued)**

| Parameter               | Conditions/Description                                                      | Min | Nom | Max | Units               |
|-------------------------|-----------------------------------------------------------------------------|-----|-----|-----|---------------------|
| Hold-Up Time            | Starting at $V_i = 230 \text{ VAC}$ , $P_o \text{ nom}$                     | -   | 16  | -   | ms                  |
| Dynamic Load Regulation | Load change =50%, $di/dt = 0.2\text{A}/\mu\text{S}$<br>voltage deviation 3% | 0   |     | 3   | % $V_o \text{ nom}$ |
| Start-Up Time           | $V_i \text{ nom}$ , $I_o \text{ nom}$                                       | 0   | -   | 2   | s                   |

**Protection**

All specifications apply over specified input voltage, output load, and temperature range, unless otherwise noted

| Parameter                   | Conditions/Description                                | Min             | Nom | Max | Units   |
|-----------------------------|-------------------------------------------------------|-----------------|-----|-----|---------|
| Input Fuse                  | Not user accessible                                   |                 |     |     |         |
| Input Transient Protection  | 2KV(CM) and 1KV(DM) surge                             |                 |     | 2   | KV (CM) |
| Output                      | No-load and short circuit proof                       | Hiccup or Latch |     |     |         |
|                             | short circuit proof                                   | Hiccup or Latch |     |     |         |
|                             | overload (latch style)                                | Hiccup          |     |     |         |
| Overvoltage Protection      | Latch style                                           | Latch           |     |     |         |
| Over temperature Protection | Automatic power shutdown at $T_C = 155^\circ\text{C}$ |                 |     |     |         |

**Characteristic Curves**

**Output vs. Temperature**

120W convection cooled and 175W continuous with 200 LFM airflow, Derating output power to 50% at  $70^\circ\text{C}$ .

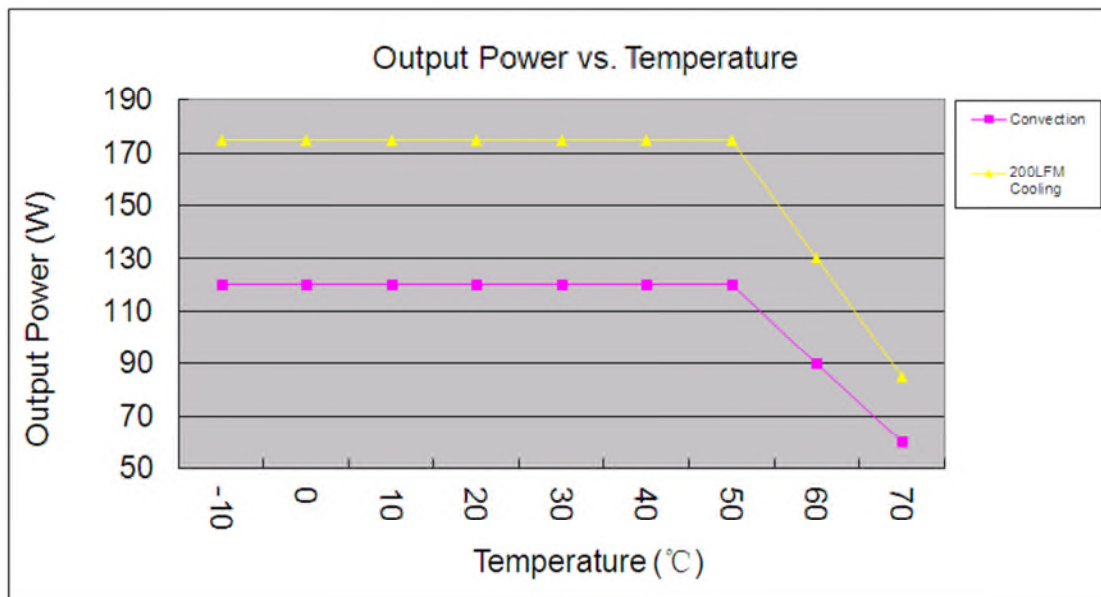

### Efficiency vs. Loading

The high efficiency is achieved by using LLC technology, PFC topology minimizing switching losses. Synchronous SCHOTTKY or ultra-fast diode is used as rectifier in CINT1175 family because of high output voltage level.

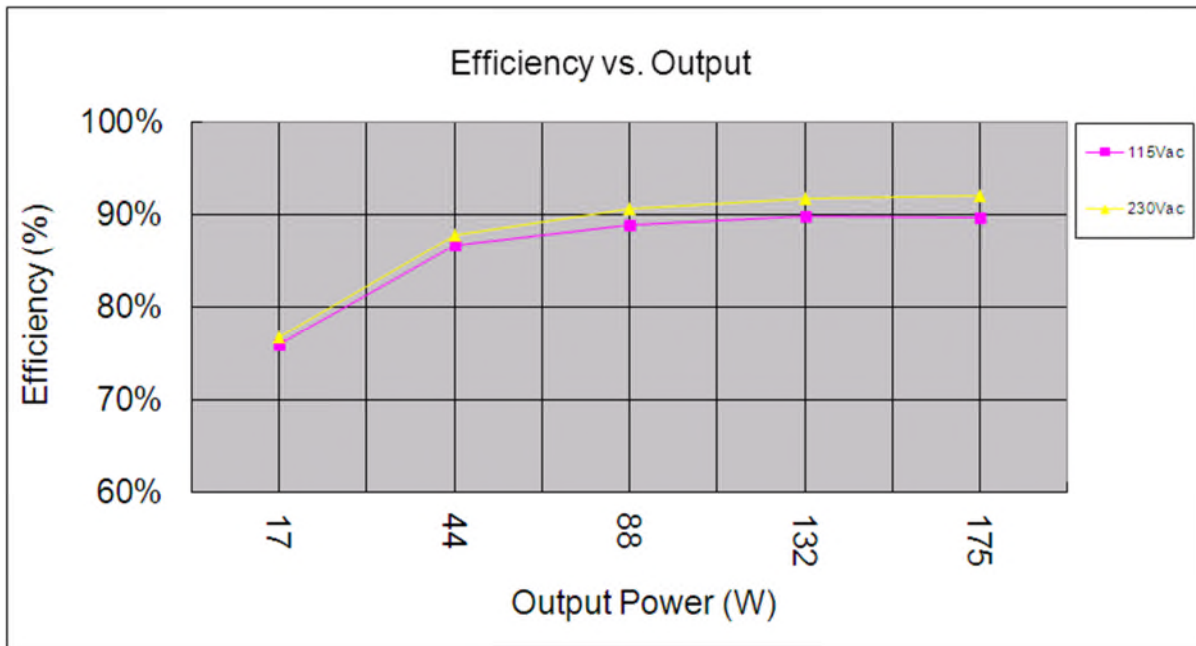

### Noise & Ripple

To verify that the output ripple and noise does not exceed the level specified in the product specification. Measured using a scope probe socket with 0.1uF ceramic and a 10uF electrolysis capacitor connected in parallel across it, BW limit with 20MHz.

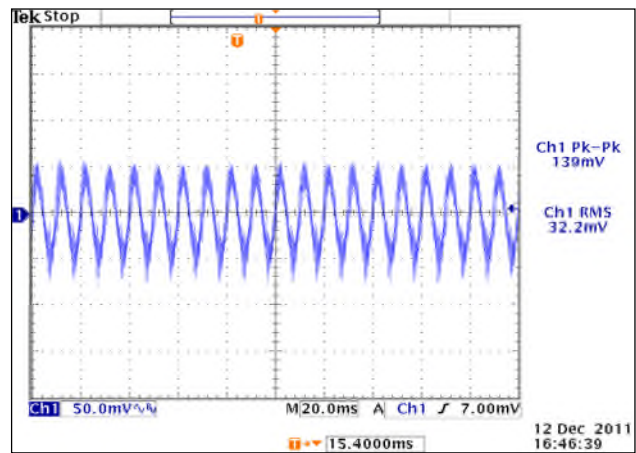
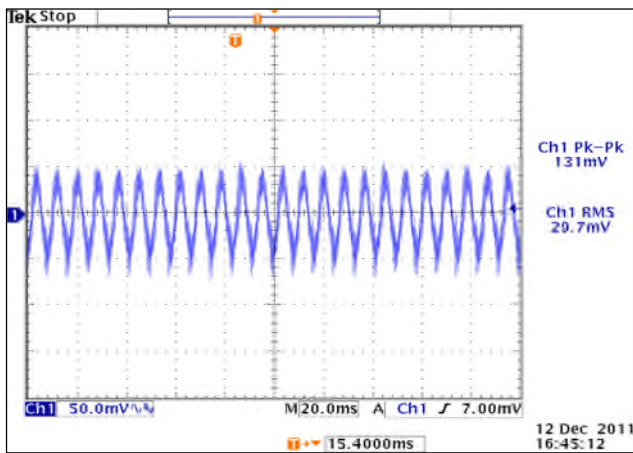

### Output Transient Response

50% load step within the regulation limits of minimum and maximum load,  $di/dt < 0.2A/\mu\text{Sec}$ . Recovery time not specified as there is no laps in regulation with a 50% Load Step. Maximum voltage deviation is 3%, This test is performed on the MAIN OUTPUT ONLY.

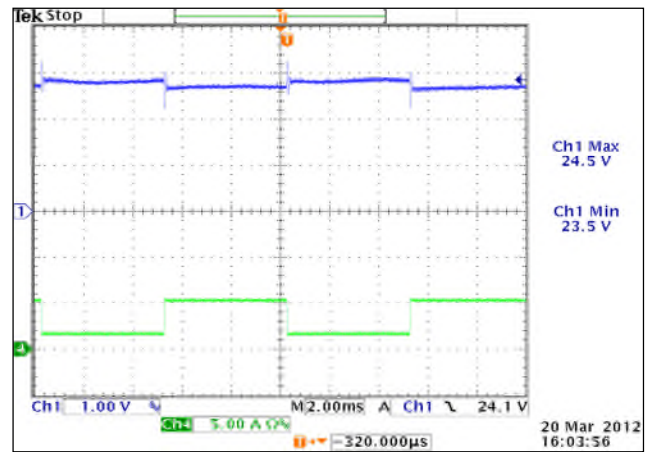
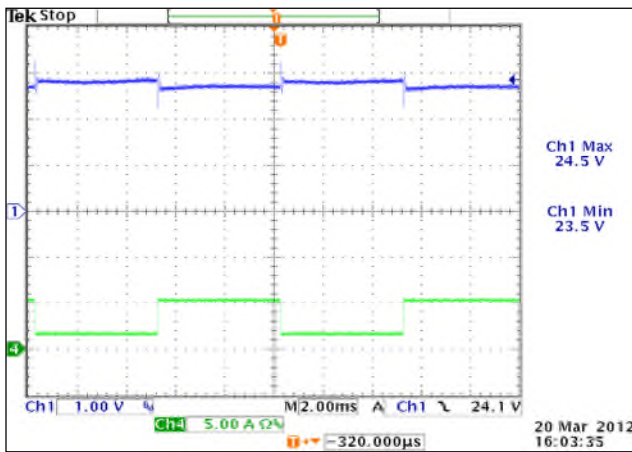

### Output Overload Characteristic

Supply shall protect itself against Overload conditions. The Power Supply shall recover from Overload Conditions without operator intervention.

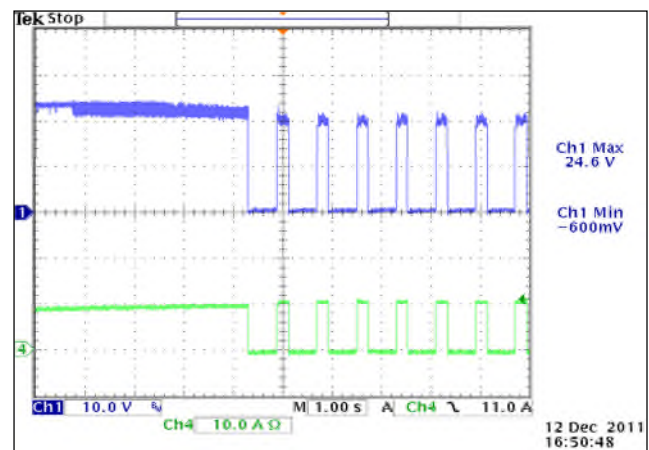
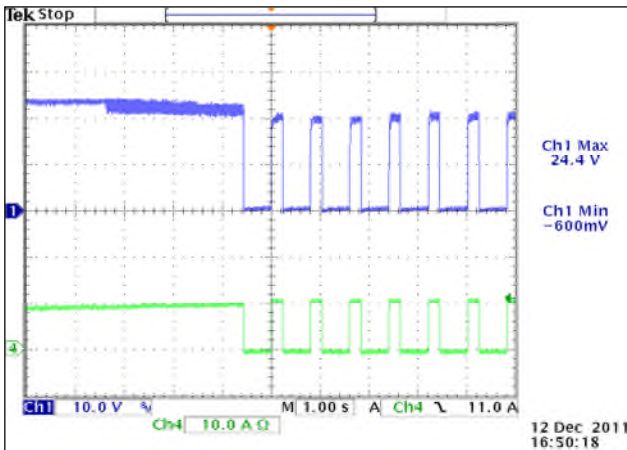

### Output Overshoot

When supply is turned on, off or when the load is stepped 100%, the Power Supply Overshoot/Undershoot shall not exceed minimum or maximum of output voltage regulation.

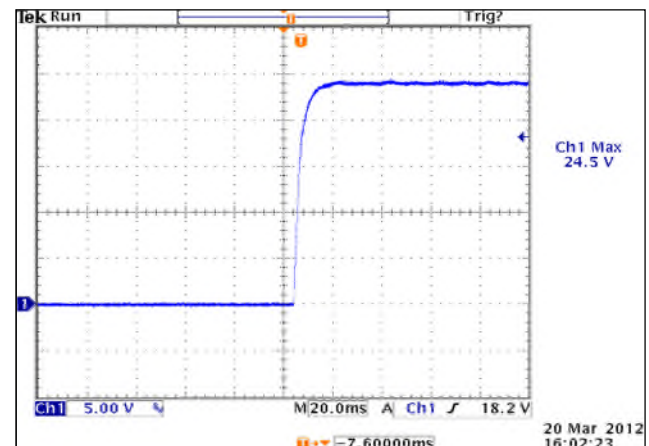
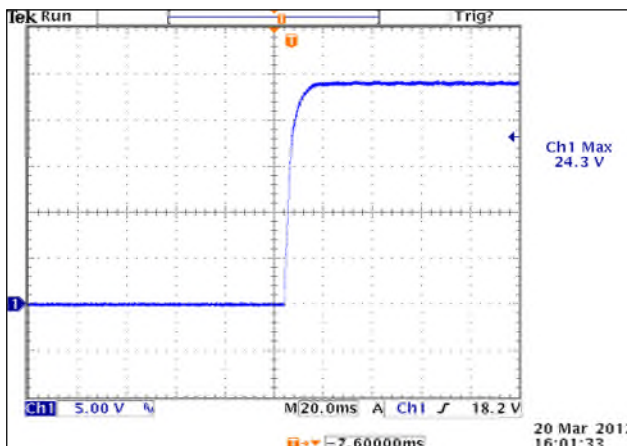



## Данный компонент на территории Российской Федерации

### Вы можете приобрести в компании MosChip.

Для оперативного оформления запроса Вам необходимо перейти по данной ссылке:

<http://moschip.ru/get-element>

Вы можете разместить у нас заказ для любого Вашего проекта, будь то серийное производство или разработка единичного прибора.

В нашем ассортименте представлены ведущие мировые производители активных и пассивных электронных компонентов.

Нашей специализацией является поставка электронной компонентной базы двойного назначения, продукции таких производителей как XILINX, Intel (ex.ALTERA), Vicor, Microchip, Texas Instruments, Analog Devices, Mini-Circuits, Amphenol, Glenair.

Сотрудничество с глобальными дистрибьюторами электронных компонентов, предоставляет возможность заказывать и получать с международных складов практически любой перечень компонентов в оптимальные для Вас сроки.

На всех этапах разработки и производства наши партнеры могут получить квалифицированную поддержку опытных инженеров.

Система менеджмента качества компании отвечает требованиям в соответствии с ГОСТ Р ИСО 9001, ГОСТ РВ 0015-002 и ЭС РД 009

### Офис по работе с юридическими лицами:

105318, г.Москва, ул.Щербаковская д.3, офис 1107, 1118, ДЦ «Щербаковский»

Телефон: +7 495 668-12-70 (многоканальный)

Факс: +7 495 668-12-70 (доб.304)

E-mail: [info@moschip.ru](mailto:info@moschip.ru)

Skype отдела продаж:

moschip.ru

moschip.ru\_4

moschip.ru\_6

moschip.ru\_9