



I6A Series DC/DC Power Modules 9-40V Input, 8A Output 75W 1/16th Brick Power Module With Polarity Inversion

Features

- Size – 33mm x 22.9 mm x 12.7 mm (1.3 in. x 0.9 in. x 0.5 in.)
- Maximum weight 15g (0.53 oz)
- Thru-hole pins 3.68mm (0.145")
- Industry standard 1/16th brick form factor
- Up to 75W of output power in high ambient temperature, low airflow environments with minimal power derating
- Polarity Inversion
- Wide output voltage adjustment range (-3.3V to -30V)
- Negative logic on/off
- Low noise
- Constant switching frequency
- Remote Sense
- Full, auto-recovery protection:
 - Input under voltage
 - Short circuit
 - Thermal limit
- ISO Certified manufacturing facilities

I6A24 power modules perform local voltage conversion from either a 12V or 24V bus. The i6A24008A033V utilizes a low component count that results in both a low cost structure and a high level of performance. The open-frame, compact, design features a low profile and weight that allow for extremely flexible and robust manufacturing processes. The high efficiency allows for the full output power to be available even in demanding thermal environments.

Optional Features

- Positive logic on/off
- Short 2.79mm (0.110") pin length
- Long 4.57mm (0.180") pin length



Advance Data Sheet: i6A Series – 1/16th brick Power Module

Ordering information:

Product Identifier	Package Size	Platform	Input Voltage	Output Current/Power	Units	Main Output Voltage	# of Outputs		Safety Class	Feature Set		RoHS Indicator
i	6	A	24	008	A	033	V	-	N	01	-	R
TDK Lambda	33mm x 22.9mm	I6A	9V to 40V	008 - 8	Amps	-3.3V to -30V	Single		N – negative output	See option table		R=RoHS 6 Compliant

Option Table:

Feature Set	Positive Logic On/Off	Negative Logic On/Off	0.145" Pin Length
-N00	X		X
-N01 (Preferred)		X	X

Product Offering:

Code	Input Voltage	Output Voltage	Output Current	Maximum Output Power	Efficiency
I6A24008A033V-NXX	9V-40V	-3.3V to -30V	8A	75W	94%



401 Mile Cars Way, Suite 125
National City, CA 91950
Phone (800)526-2324 Toll Free

Lambda.TechSupport@us.tdk-lambda.com
www.us.tdk-lambda.com/lp/

Mechanical Specification:

Dimensions are in mm [in]. Unless otherwise specified tolerances are: $x.x \pm 0.5$ [0.02], $x.xx \pm 0.25$ [0.010]

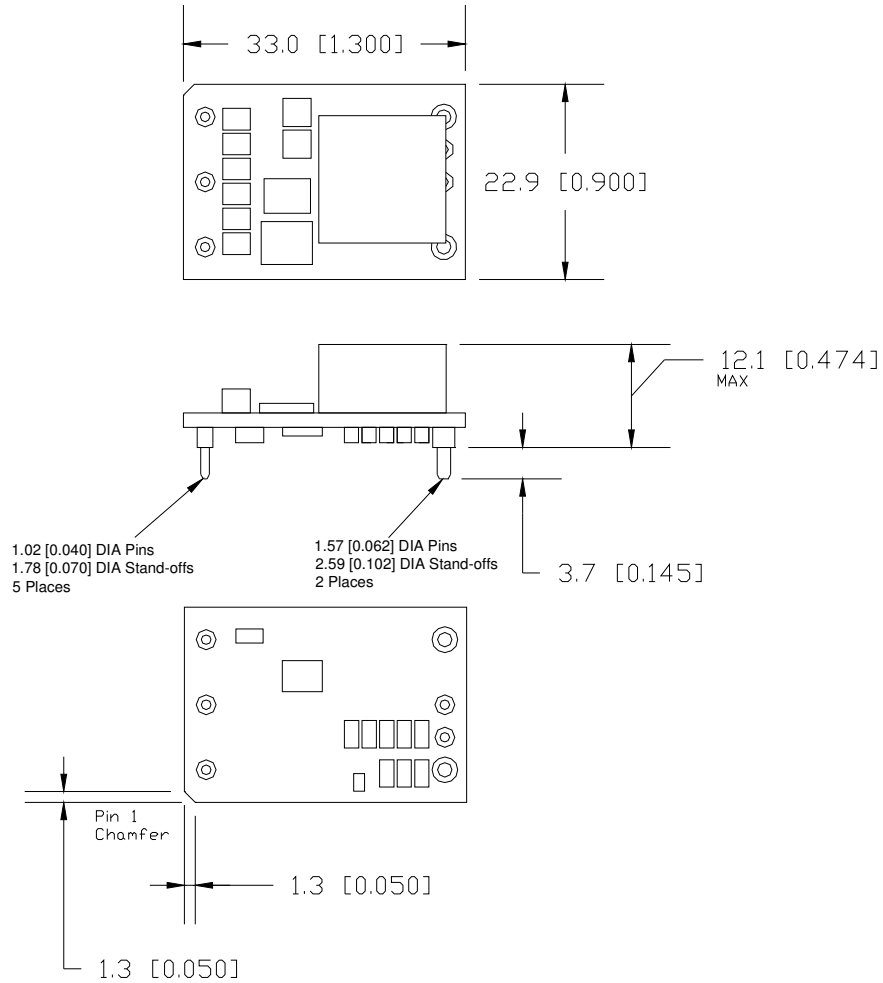

Recommended Hole Pattern – Standard (top view):

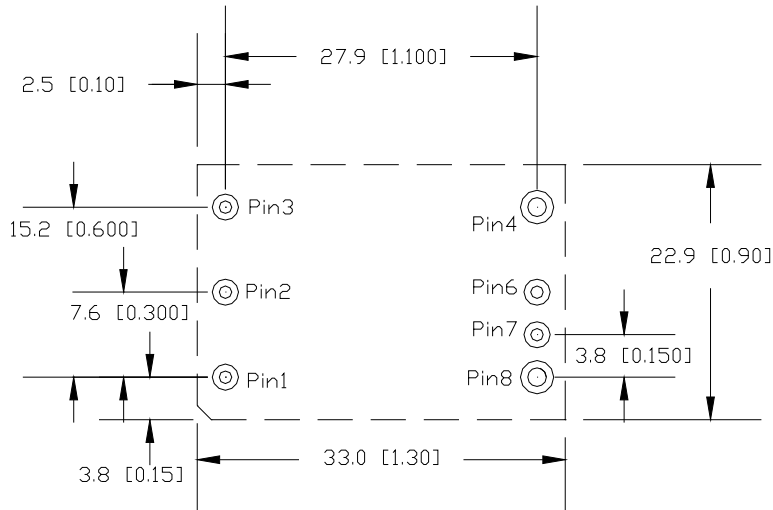

Pin Assignment:

PIN	FUNCTION	PIN	FUNCTION
1	Vin (+)	7	SENSE (+)
2	On/Off	8	GND
3	Vout (-)		
4	Vout (-)		
6	TRIM		

Pin base material is copper or brass with gold over nickel plating; the maximum module weight is 15g (0.53 oz.)

Advance Data Sheet: i6A Series – 1/16th brick Power Module

Absolute Maximum Ratings:

Stress in excess of Absolute Maximum Ratings may cause permanent damage to the device.

Characteristic	Min	Max	Unit	Notes & Conditions
Continuous Input Voltage	-0.25	50	Vdc	
Input Voltage and Output Voltage Summation		53	Vdc	Vout + Vin
Isolation Voltage	---	---	Vdc	None
Storage Temperature	-55	125	°C	
Operating Temperature Range (Tc)	-40	125*	°C	Measured at the location specified in the thermal measurement figure; maximum temperature varies with output current – see curve in the thermal performance section of the data sheet.

* Engineering estimate

Input Characteristics:

Unless otherwise specified, specifications apply over all rated Input Voltage, Resistive Load, and Temperature conditions.

Characteristic	Min	Typ	Max	Unit	Notes & Conditions
Operating Input Voltage	10	---	40	Vdc	
Maximum Input Current	---	---	15	A	Vin= 0 to Vin,max; Io=Io,max
Startup Delay Time from application of input voltage	---	4	---	mS	Vo=0 to 0.1*Vo,set; on/off=on, Io=Io,max, Tc=25°C
Startup Delay Time from on/off	---	4	---	mS	Vo=0 to 0.1*Vo,set; Vin=Vi,nom, Io=Io,max, Tc=25°C
Output Voltage Rise Time	---	10	---	mS	Io=Io,max, Tc=25°C, Vo=0.1 to 0.9*Vo,set
Input Ripple Rejection	---	50*	---	dB	@ 120 Hz
Turn on input voltage	---	8	---	V	
Turn off input voltage	---	7	9	V	

*Engineering Estimate

Caution: The power modules are not internally fused. An external input line normal blow fuse with a maximum value of 20A is required, see the Safety Considerations section of the data sheet.

Electrical Data:

Characteristic	Min	Typ	Max	Unit	Notes & Conditions
Output Voltage Initial Setpoint	-2.5	-	+2.5	%	$V_o=3.3V_{\text{setting}}$, $V_{in}=V_{in,nom}$; $I_o=I_o,max$; $T_c = 25^\circ C$
Output Voltage Tolerance	-4	-	+4	%	Over all rated input voltage, load, and temperature conditions to end of life
Efficiency					$V_{in}=12V$; $I_o=I_o,max$; $T_c=25^\circ C$
	$V_o = -3.3V$	---	90	---	%
	$V_o = -5V$	---	91	---	%
	$V_o = -12V$	---	93	---	%
	$V_o = -18V$	---	94	---	%
	$V_o = -28V$	---	94	---	%
Efficiency					$V_{in}=24V$; $I_o=I_o,max$; $T_c=25^\circ C$
	$V_o = -3.3V$	---	90	---	%
	$V_o = -5V$	---	92	---	%
	$V_o = -12 V$	---	94	---	%
	$V_o = -18V$	---	93.5	---	%
Line Regulation	---	0.5	---	%	$V_{in}=V_{in,min}$ to $V_{in,max}$
Load Regulation	---	0.6	---	%	$I_o=I_o,min$ to I_o,max
Output Current	0	---	8	A	Observe maximum power limit
Output Current Limiting Threshold	---	15	---	A	$V_o = 0.9 \cdot V_o,nom$, $T_c < T_c,max$
Short Circuit Current	---	0.5	---	A	$V_o = 0.25V$, $T_c = 25^\circ C$
Output Ripple and Noise Voltage	---	20	---	mVpp	Measured across one 0.1 uF ceramic capacitor and one 20uF ceramic capacitor – see input/output ripple measurement figure; BW = 20MHz.
Output Voltage Adjustment Range	-3.3	---	-30	V	Refer to output adjustment curve on page 10
Input and Output Voltage Summation	---	---	48	V	$ V_{in} + V_o $
Output Voltage Sense Range	---	---	5	%	
Dynamic Response: Recovery Time	---	200	---	uS	$di/dt = 1A/uS$, $V_{in}=V_{in,nom}$; $V_o=12V$, load step from 25% to 75% of I_o,max
Transient Voltage	---	200	---	mV	
Switching Frequency	---	400	---	kHz	Fixed
External Load Capacitance	200	---	1600*	uF	Maximum capacitor varies with output voltage, $C_{max} = 1600 - (47x V_{out})uF$
Vref	---	0.6	---	V	Required for trim calculation
F	---	36500	---	Ω	Required for trim calculation
G	---	511	---	Ω	Required for trim calculation

*Please contact TDK Lambda for technical support for very low esr capacitor banks or if higher capacitance is required

Electrical Characteristics:

Typical Efficiency vs. Input Voltage

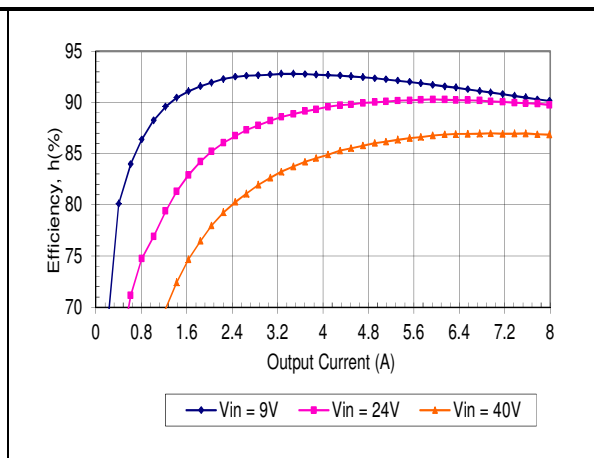
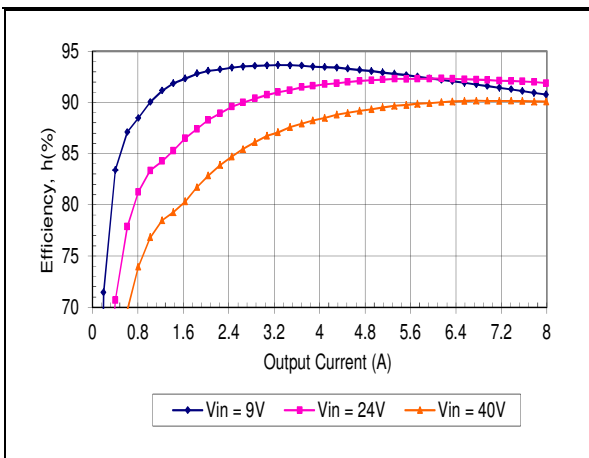
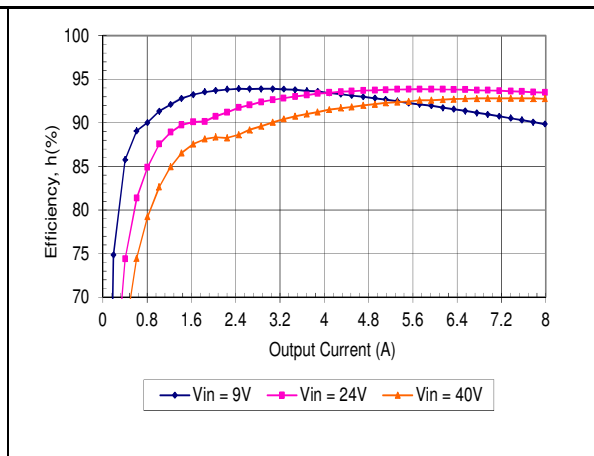
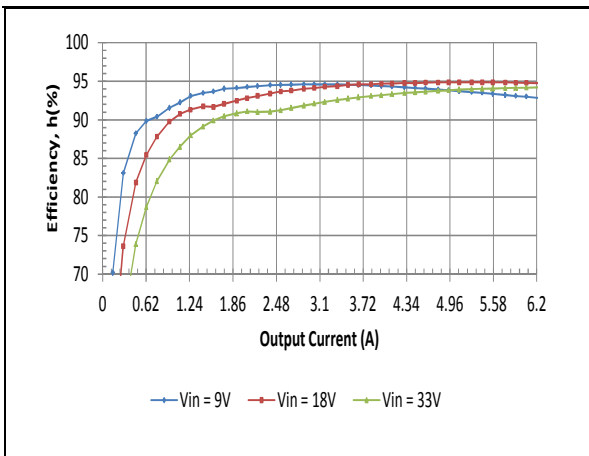
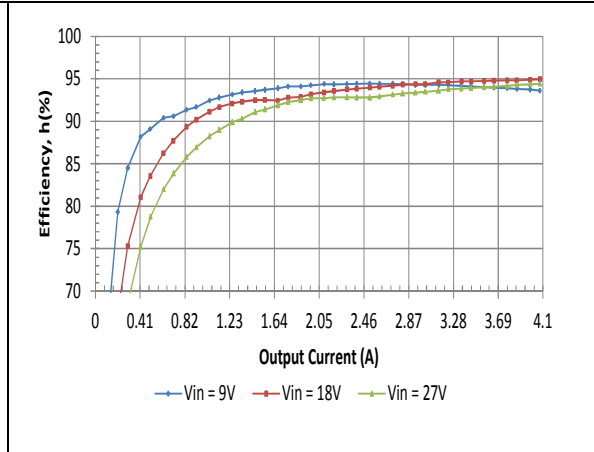
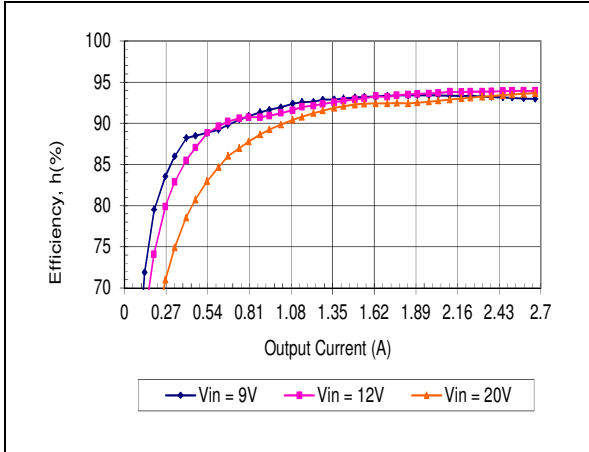

Electrical Characteristics:

Typical Power Dissipation vs. Input Voltage

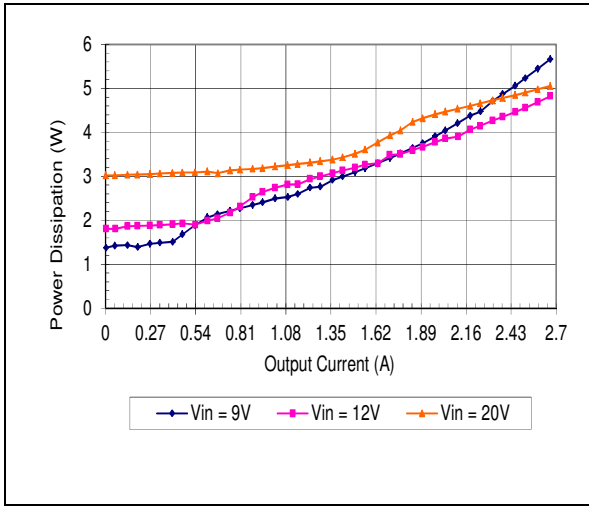

Vo = -28V

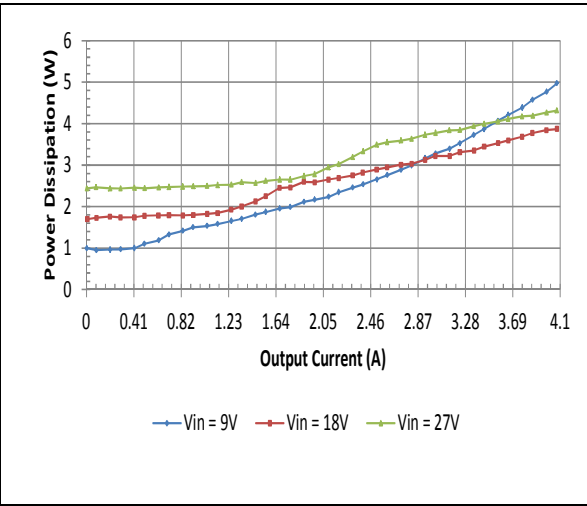

Vo = -18V

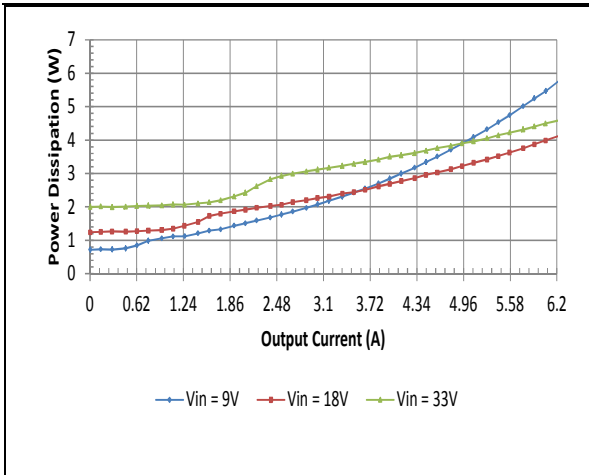

Vo = -12V

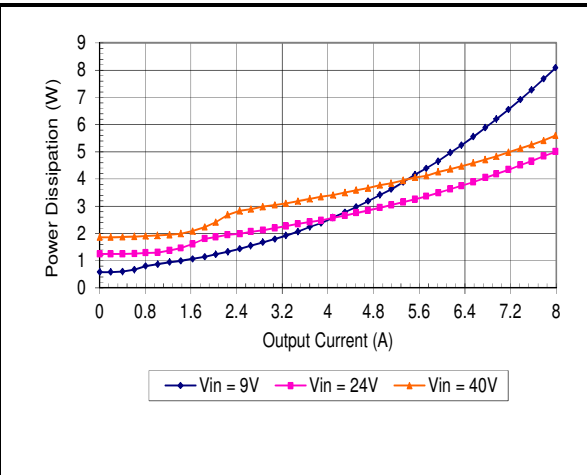

Vo = -9V

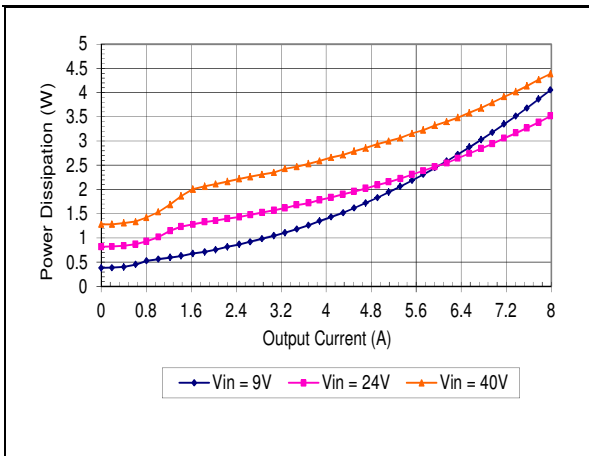

Vo = -5V

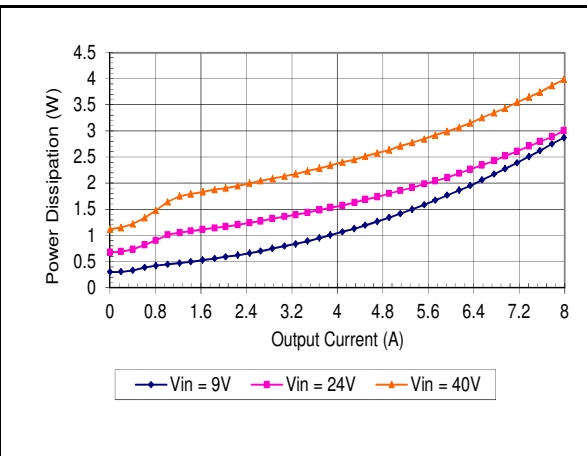

Vo = -3.3V

Electrical Characteristics:

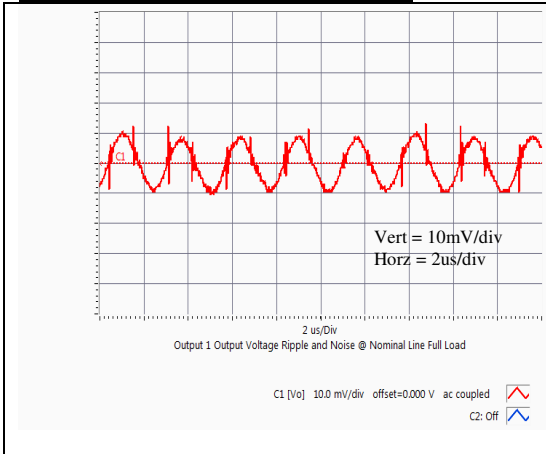

Vo=-12V Typical Output Ripple at nominal Input voltage and full load at Ta=25 degrees

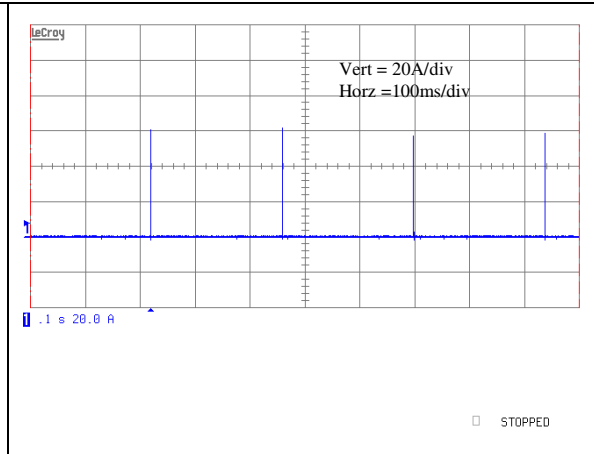

Typical Output Short Circuit Current – CH3, blue

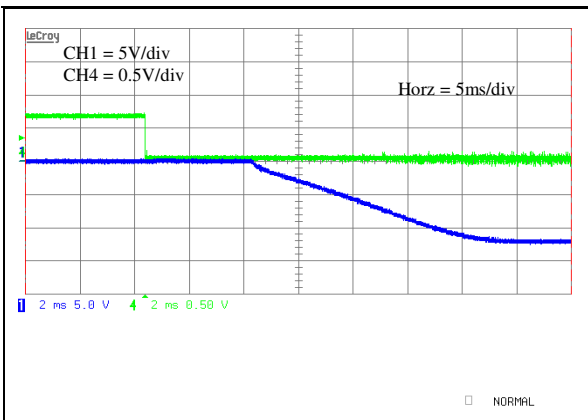

Vo=-12V Typical startup characteristic from on/off at full load. Ch1 - output voltage, Ch4 – on/off signal

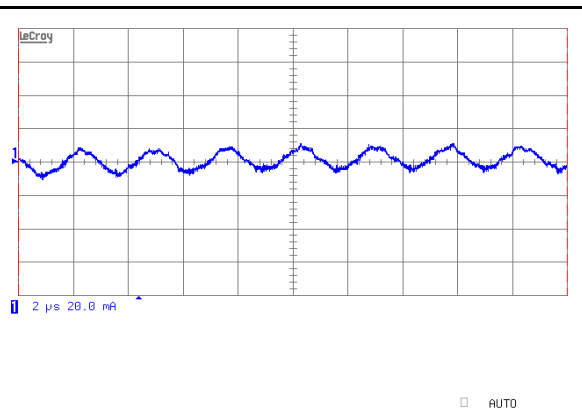

Vo=-12V Typical Input Ripple at nominal Input Voltage and full load at Ta=25 degrees. Input capacitors 1x 22uF ceramic and 1x100uF electrolytic

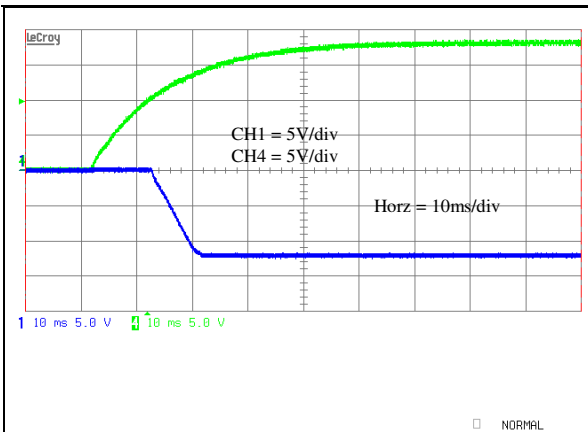

Vo=-12V Typical startup characteristic from input voltage application at full load. Ch1 - output voltage, Ch4 – input voltage

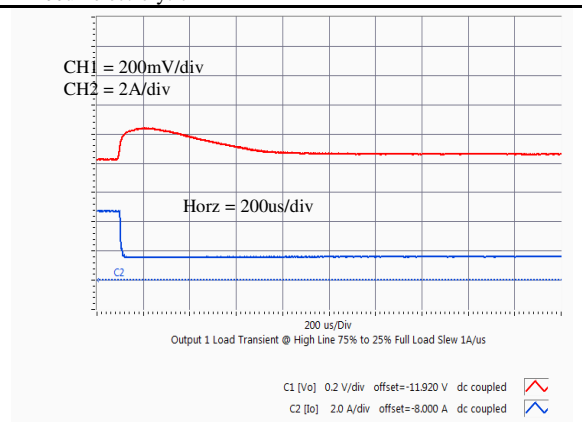

Vo=-12V Typical output voltage transient response to load step from 75% to 25% of full load with output current slew rate of 1A/uS. (Cext = 200uF)

Electrical Characteristics (continued):

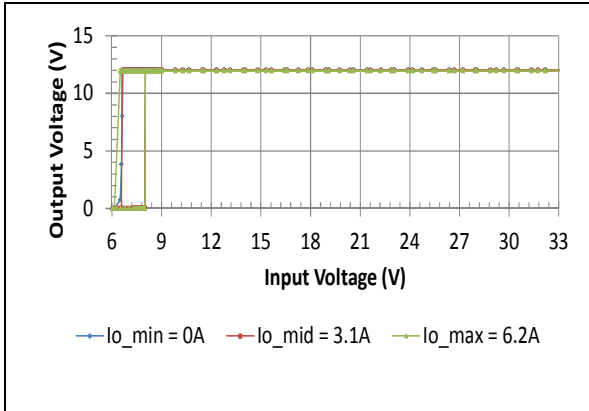

Vo=-12V Typical Output Voltage vs. Input Voltage Characteristics

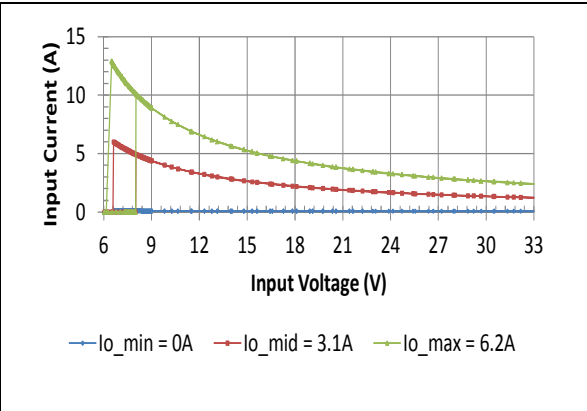

Vo=-12V Typical Input Current vs. Input Voltage Characteristics

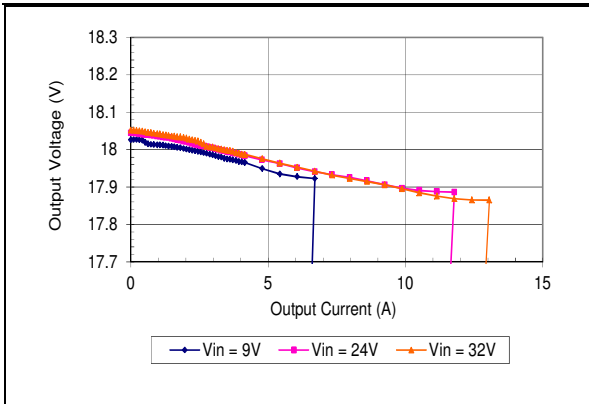

Vo=-18V Typical Current Limit Characteristics

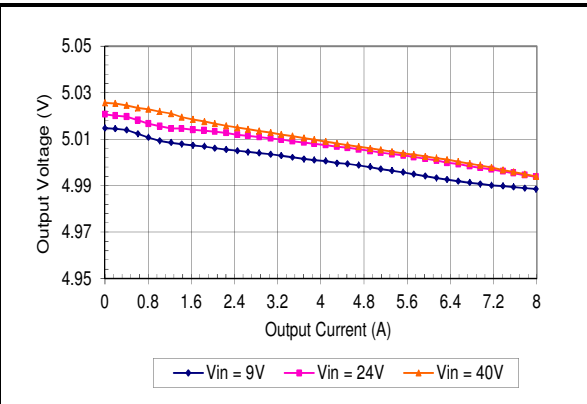

Vo=-5V Typical load regulation

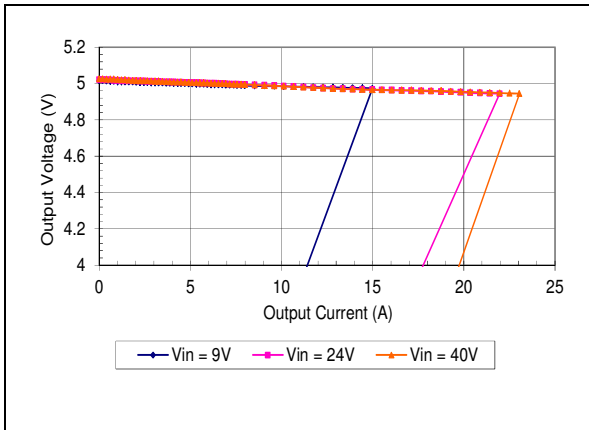

Vo=-5V Typical Current Limit Characteristics

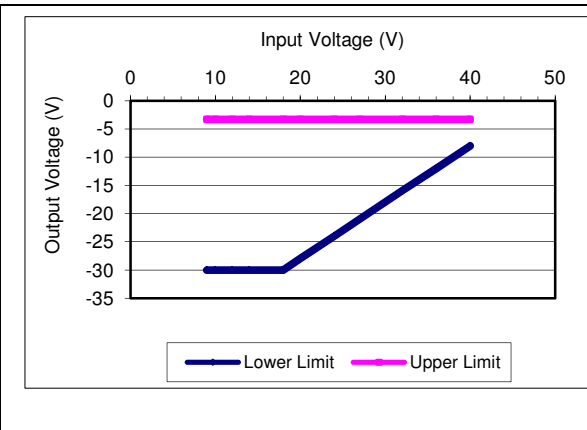

Output Voltage versus Input Voltage Operating Range

Thermal Performance:

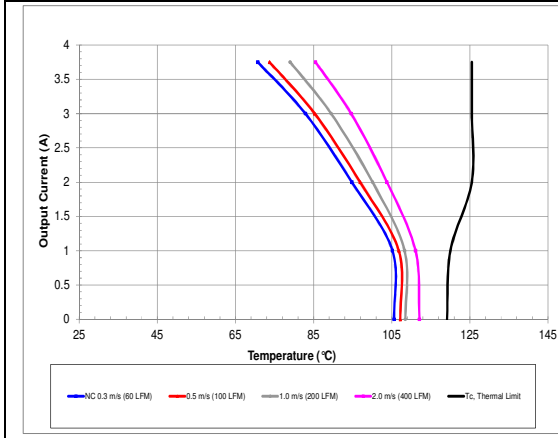

Vo=-24V, Vin=15V maximum output current vs. ambient temperature for natural convection (60lfm) to 400lfm with airflow from pin 8 to pin 4.

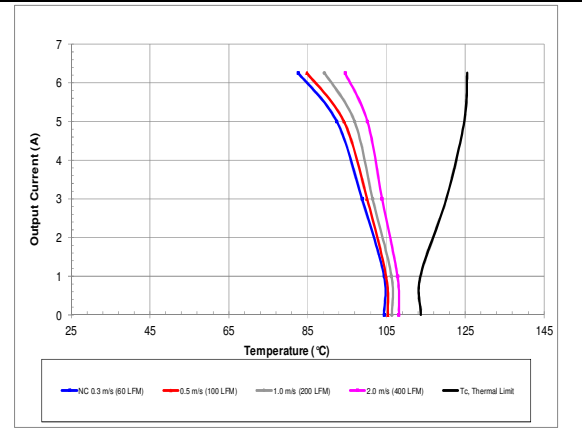

Vo=-12V, Vin=20V maximum output current vs. ambient temperature for natural convection (60lfm) to 400lfm with airflow from pin 8 to pin 4.

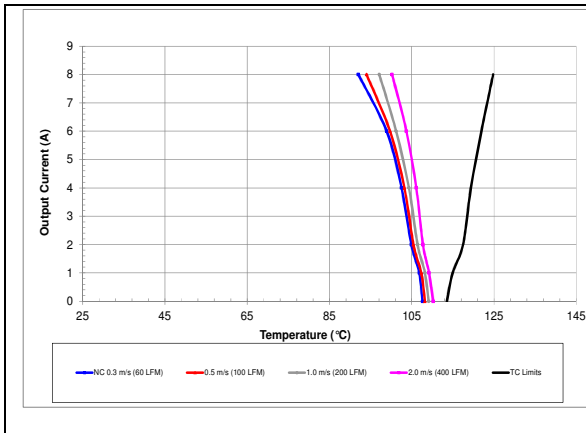

Vo=-5V, Vin=24V maximum output current vs. ambient temperature for natural convection (60lfm) to 400lfm with airflow from pin 8 to pin 4.

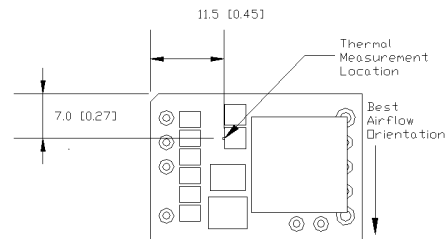

i6A24008A033V thermal measurement location – top view

The thermal curves provided are based upon measurements made in TDK Lambda's experimental test setup that is described in the Thermal Management section. Due to the large number of variables in system design, TDK Lambda recommends that the user verify the module's thermal performance in the end application. The critical component should be thermo coupled and monitored, and should not exceed the temperature limit specified in the derating curve above. It is critical that the thermocouple be mounted in a manner that gives direct thermal contact or significant measurement errors may result. TDK Lambda can provide modules with a thermocouple pre-mounted to the critical component for system verification tests.

Thermal Management:

An important part of the overall system design process is thermal management; thermal design must be considered at all levels to ensure good reliability and lifetime of the final system. Superior thermal design and the ability to operate in severe application environments are key elements of a robust, reliable power module.

A finite amount of heat must be dissipated from the power module to the surrounding environment. This heat is transferred by the three modes of heat transfer: convection, conduction and radiation. While all three modes of heat transfer are present in every application, convection is the dominant mode of heat transfer in most applications. However, to ensure adequate cooling and proper operation, all three modes should be considered in a final system configuration.

The open frame design of the power module provides an air path to individual components. This air path improves convection cooling to the surrounding environment, which reduces areas of heat concentration and resulting hot spots.

Test Setup: The thermal performance data of the power module is based upon measurements obtained from a wind tunnel test with the setup shown in the wind tunnel figure. This thermal test setup replicates the typical thermal environments encountered in most modern electronic systems with distributed power architectures. The electronic equipment in networking, telecom, wireless, and advanced computer systems operates in similar environments and utilizes vertically mounted PCBs or circuit cards in cabinet racks.

The power module, as shown in the figure, is mounted on a printed circuit board (PCB) and is vertically oriented within the wind tunnel. The cross section of the airflow passage is rectangular. The spacing between the top of the module and a parallel facing PCB is kept at a constant (0.5 in). The power module's orientation with respect to the airflow direction can have a significant impact on the module's thermal performance.

Thermal Derating: For proper application of the power module in a given thermal environment, output current derating curves are provided as a design guideline on the Thermal Performance section for the

power module of interest. The module temperature should be measured in the final system configuration to ensure proper thermal management of the power module. For thermal performance verification, the module temperature should be measured at the component indicated in the thermal measurement location figure on the thermal performance page for the power module of interest. In all conditions, the power module should be operated below the maximum operating temperature shown on the derating curve. For improved design margins and enhanced system reliability, the power module may be operated at temperatures below the maximum rated operating temperature.

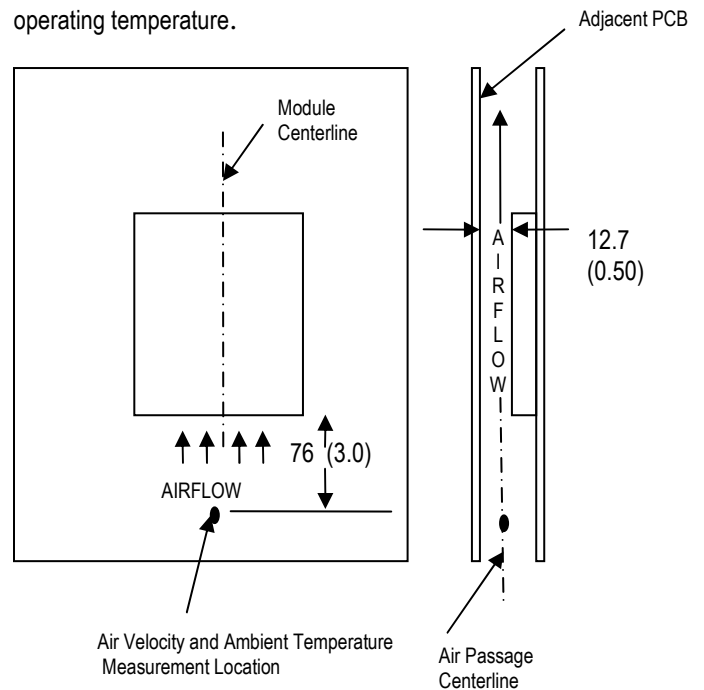

Wind Tunnel Test Setup Figure Dimensions are in millimeters and (inches).

Heat transfer by convection can be enhanced by increasing the airflow rate that the power module experiences. The maximum output current of the power module is a function of ambient temperature (T_{AMB}) and airflow rate as shown in the thermal performance figures on the thermal performance page for the power module of interest. The curves in the figures are shown for natural convection through 2 m/s (400 ft/min). The data for the natural convection condition has been collected at 0.3 m/s (60 ft/min) of airflow, which is the typical airflow generated by other heat dissipating components in many of the systems that these types of modules are used in. In the final system configurations, the airflow rate for the natural convection condition can vary due to temperature gradients from other heat dissipating components.

Operating Information:

Over-Current Protection: The power modules have short circuit protection to protect the module during severe overload conditions. During overload conditions, the power modules may protect themselves by entering a hiccup current limit mode. The modules will operate normally once the output current returns to the specified operating range. Long term operation outside the rated conditions and prior to the hiccup protection engaging is not recommended unless measures are taken to ensure the module's thermal limits are being observed.

Remote On/Off: - The power modules have an internal remote on/off circuit. The user must supply compatible switch between the GND pin and the on/off pin. The maximum voltage generated by the power module at the on/off terminal is $V_{in,max}$. The maximum allowable leakage current of the switch is 10 μ A. The switch must be capable of maintaining a low signal $V_{on/off} < 0.25V$ while sinking 1mA.

The standard on/off logic is negative logic. In the circuit configuration shown the power module will turn on if the external switch is on and it will be off if the switch is off and the on/off pin is open. If the negative logic feature is not being used, terminal 2 should be connected to ground. A voltage source should not be applied to the on/off terminal.

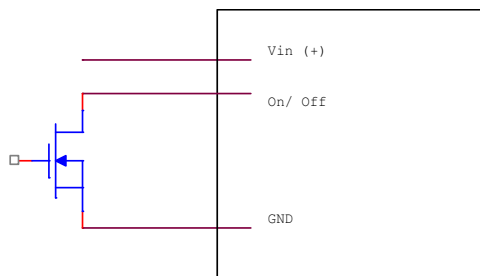

On/Off Circuit for positive or negative logic

An optional positive logic is available. In the circuit configuration shown the power module will turn on if the external switch is off and it will be off if the external switch is on. If the negative logic feature is not being used, terminal 2 should be left open.

Remote Sense: The power modules feature remote sense to compensate for the effect of output distribution drops. The output voltage sense range defines the maximum voltage allowed between the output power terminal (pin 8) and output sense terminal (pin 7), and it is found on the electrical data page for the power module of interest. If the remote sense feature is not being used, the Sense terminal should be connected to the GND terminal.

The magnitude of the output voltage at the V_o terminal can be increased by either the remote sense or the output voltage adjustment feature. The maximum voltage increase allowed is the larger of the remote sense range or the output voltage adjustment range; it is not the sum of both. As the output voltage increases due to the use of the remote sense, the maximum output current may need to be decreased for the power module to remain below its maximum power rating.

Output Voltage Adjustment: The output voltage of the power module may be adjusted by using an external resistor connected between the V_{out} trim terminal and $V_{out}(-)$ terminal. Care should be taken to avoid injecting noise into the power module's trim pin.

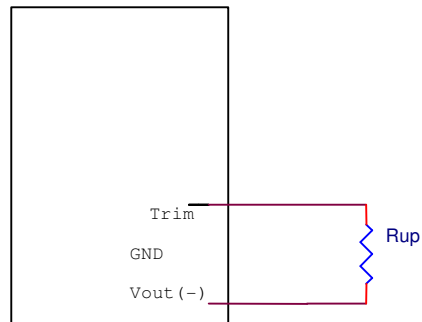

Circuit to increase output voltage

With a resistor between the trim and $V_{out}(-)$ terminals, the output voltage is adjusted up. To adjust the output voltage from $V_{o,nom}$ to $V_{o,up}$ the trim resistor should be chosen according to the following equation:

$$R_u := \left(\frac{V_{ref} \cdot F}{V_{oup} - V_{onom}} \right) - G$$

The values of V_{ref} , G and F are found in the electrical data section for the power module of interest.

The maximum power available from the power module is fixed. As the output voltage is trimmed up, the maximum output current must be decreased to maintain the maximum rated power of the module.

e.g. $V_o = 5V$

$$R_u := \left(\frac{0.636500}{5 - 0.6} \right) - 511$$

Vout (V)	Ru (Kohm)
3.3	7.6
5	4.47
9.6	1.92
12	1.41
18	0.75

EMC Considerations: TDK Lambda power modules are designed for use in a wide variety of systems and applications. For assistance with designing for EMC compliance, please contact TDK Lambda technical support.

Input Impedance:

The source impedance of the power feeding the DC/DC converter module will interact with the DC/DC converter. To minimize the interaction, low-esr capacitors should be located at the input to the module. It is recommended that a 22uF ceramic input capacitor be placed as close as possible to the module. Data is provided on the electrical characteristics page, showing the typical input ripple voltage with 100uF electrolytic capacitor.

Reliability:

The power modules are designed using TDK Lambda's stringent design guidelines for component derating, product qualification, and design reviews. The MTBF is calculated to be greater than 10 million hours at full output power and $T_a = 40^\circ C$ using the Telcordia SR-332 calculation method.

Quality:

TDK Lambda's product development process incorporates advanced quality planning tools such as FMEA and Cpk analysis to ensure designs are robust and reliable. All products are assembled at ISO certified assembly plant

Input/Output Ripple and Noise Measurements:

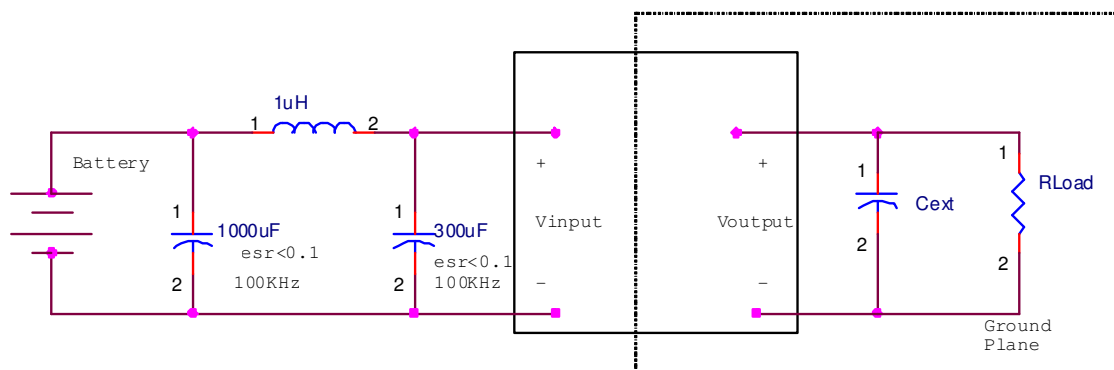

The input reflected ripple is measured with a current probe and oscilloscope. The ripple current is the current through the 1uH inductor.

The output ripple measurement is made approximately 9 cm (3.5 in.) from the power module using an oscilloscope and BNC socket. The capacitor Cext is located about 5 cm (2 in.) from the power module; its value varies from code to code and is found on the electrical data page for the power module of interest under the ripple & noise voltage specification in the Notes & Conditions column.



Advance Data Sheet: i6A Series – 1/16th brick Power Module

Safety Considerations:

As of the publishing date, certain safety agency approvals may have been received on the i6A series and others may still be pending. Check with TDK Lambda for the latest status of safety approvals on the i6A product line.

For safety agency approval of the system in which the DC-DC power module is installed, the power module must be installed in compliance with the creepage and clearance requirements of the safety agency.

To preserve maximum flexibility, the power modules are not internally fused. An external input line normal

blow fuse with a maximum value of 20A is required by safety agencies. A lower value fuse can be selected based upon the maximum dc input current and maximum inrush energy of the power module.

Warranty:

TDK Lambda's comprehensive line of power solutions includes efficient, high-density DC-DC converters. TDK Lambda offers a three-year limited warranty. Complete warranty information is listed on our web site or is available upon request from TDK Lambda.



401 Mile Cars Way, Suite 125
National City, CA 91950
Phone (800)526-2324 Toll Free

Lambda.TechSupport@us.tdk-lambda.com
www.us.tdk-lambda.com/lp/

Information furnished by TDK Lambda is believed to be accurate and reliable. However, TDK Lambda assumes no responsibility for its use, nor for any infringement of patents or other rights of third parties, which may result from its use. No license is granted by implication or otherwise under any patent or patent rights of TDK Lambda. TDK components are not designed to be used in applications, such as life support systems, wherein failure or malfunction could result in injury or death. All sales are subject to TDK Lambda's Terms and Conditions of Sale, which are available upon request. Specifications are subject to change without

Данный компонент на территории Российской Федерации

Вы можете приобрести в компании MosChip.

Для оперативного оформления запроса Вам необходимо перейти по данной ссылке:

<http://moschip.ru/get-element>

Вы можете разместить у нас заказ для любого Вашего проекта, будь то серийное производство или разработка единичного прибора.

В нашем ассортименте представлены ведущие мировые производители активных и пассивных электронных компонентов.

Нашей специализацией является поставка электронной компонентной базы двойного назначения, продукции таких производителей как XILINX, Intel (ex.ALTERA), Vicor, Microchip, Texas Instruments, Analog Devices, Mini-Circuits, Amphenol, Glenair.

Сотрудничество с глобальными дистрибьюторами электронных компонентов, предоставляет возможность заказывать и получать с международных складов практически любой перечень компонентов в оптимальные для Вас сроки.

На всех этапах разработки и производства наши партнеры могут получить квалифицированную поддержку опытных инженеров.

Система менеджмента качества компании отвечает требованиям в соответствии с ГОСТ Р ИСО 9001, ГОСТ РВ 0015-002 и ЭС РД 009

Офис по работе с юридическими лицами:

105318, г.Москва, ул.Щербаковская д.3, офис 1107, 1118, ДЦ «Щербаковский»

Телефон: +7 495 668-12-70 (многоканальный)

Факс: +7 495 668-12-70 (доб.304)

E-mail: info@moschip.ru

Skype отдела продаж:

moschip.ru

moschip.ru_4

moschip.ru_6

moschip.ru_9