

RF POWER MOSFET N-CHANNEL ENHANCEMENT MODE

300V 750W 40MHz

The ARF1505 is an RF power transistor designed for off-line 300V operation in very high power scientific, commercial, medical and industrial RF power generator and amplifier applications up to 40 MHz.

- **Specified 300 Volt, 27.12 MHz Characteristics:**
 - Output Power = 750 Watts.
 - Gain = 17dB (Class C)
 - Efficiency > 75%
- **High Performance Power RF Package.**
- **Very High Breakdown for Improved Ruggedness.**
- **Low Thermal Resistance.**
- **Nitride Passivated Die for Improved Reliability.**
- **RoHS Compliant** 

MAXIMUM RATINGS

 All Ratings: $T_C = 25^\circ\text{C}$ unless otherwise specified.

Symbol	Parameter	ARF1505	UNIT
V_{DSS}	Drain-Source Voltage	1200	Volts
I_D	Continuous Drain Current @ $T_C = 25^\circ\text{C}$	25	Amps
V_{GS}	Gate-Source Voltage	± 30	Volts
P_D	Total Device Dissipation @ $T_C = 25^\circ\text{C}$	1500	Watts
T_J, T_{STG}	Operating and Storage Junction Temperature Range	-55 to 175	°C
T_L	Lead Temperature: 0.063" from Case for 10 Sec.	300	

STATIC ELECTRICAL CHARACTERISTICS

Symbol	Characteristic / Test Conditions	MIN	TYP	MAX	UNIT
BV_{DSS}	Drain-Source Breakdown Voltage ($V_{GS} = 0V, I_D = 250 \mu\text{A}$)	1200			Volts
$V_{DS(ON)}$	On State Drain Voltage ^① ($I_{D(ON)} = 12.5A, V_{GS} = 10V$)		8	9.5	
I_{DSS}	Zero Gate Voltage Drain Current ($V_{DS} = V_{DSS}, V_{GS} = 0V$)			100	μA
	Zero Gate Voltage Drain Current ($V_{DS} = 0.8 V_{DSS}, V_{GS} = 0V, T_C = 125^\circ\text{C}$)			1000	
I_{GSS}	Gate-Source Leakage Current ($V_{GS} = \pm 30V, V_{DS} = 0V$)			± 400	nA
g_{fs}	Forward Transconductance ($V_{DS} = 25V, I_D = 12.5A$)	5.5	6		mhos
$V_{isolation}$	RMS Voltage (60Hz Sinewave from terminals to mounting surface for 1 minute)	TBD			Volts
$V_{GS(TH)}$	Gate Threshold Voltage ($V_{DS} = V_{GS}, I_D = 50mA$)	3		5	Volts

THERMAL CHARACTERISTICS

Symbol	Characteristic (per package unless otherwise noted)	MIN	TYP	MAX	UNIT
$R_{\theta JC}$	Junction to Case			0.10	°C/W
$R_{\theta JHS}$	Junction to Sink (Use High Efficiency Thermal Joint Compound and Planar Heat Sink Surface.)		0.16		



CAUTION: These Devices are Sensitive to Electrostatic Discharge. Proper Handling Procedures Should Be Followed.

Symbol	Characteristic	Test Conditions	MIN	TYP	MAX	UNIT
C_{iss}	Input Capacitance	$V_{GS} = 0V$ $V_{DS} = 200V$ $f = 1\text{ MHz}$		5400	6500	pF
C_{oss}	Output Capacitance			300	400	
C_{rss}	Reverse Transfer Capacitance			125	160	
$t_{d(on)}$	Turn-on Delay Time	$V_{GS} = 15V$ $V_{DD} = 0.5 V_{DSS}$ $I_D = I_{D[Cont.]}$ @ 25°C $R_G = 1.6\Omega$		8		ns
t_r	Rise Time			5		
$t_{d(off)}$	Turn-off Delay Time			25		
t_f	Fall Time			13		

FUNCTIONAL CHARACTERISTICS

Symbol	Characteristic	Test Conditions	MIN	TYP	MAX	UNIT
G_{PS}	Common Source Amplifier Power Gain	$f = 27.12\text{ MHz}$	15	17		dB
η	Drain Efficiency	$V_{GS} = 0V$ $V_{DD} = 300V$ $P_{out} = 750W$	70	75		%
Ψ	Electrical Ruggedness VSWR 10:1		No Degradation in Output Power			

① Pulse Test: Pulse width < 380 μs, Duty Cycle < 2%.

Microsemi reserves the right to change, without notice, the specifications and information contained herein.

Per transistor section unless otherwise specified.

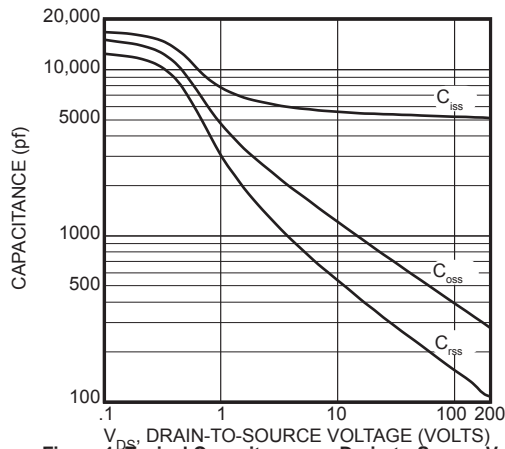

Figure 1, Typical Capacitance vs. Drain-to-Source Voltage

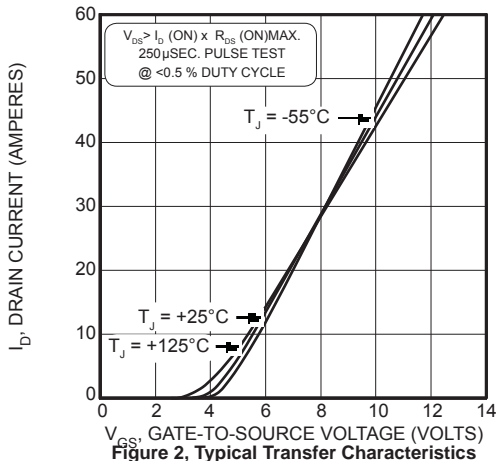

Figure 2, Typical Transfer Characteristics

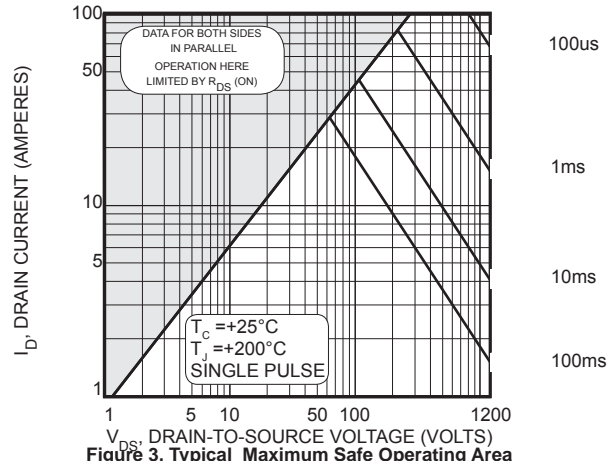

Figure 3, Typical Maximum Safe Operating Area

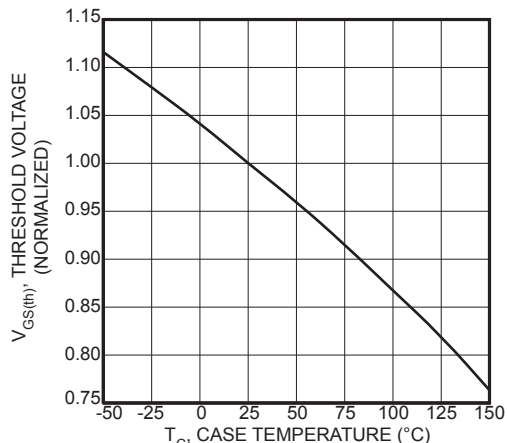

Figure 4, Typical Threshold Voltage vs Temperature

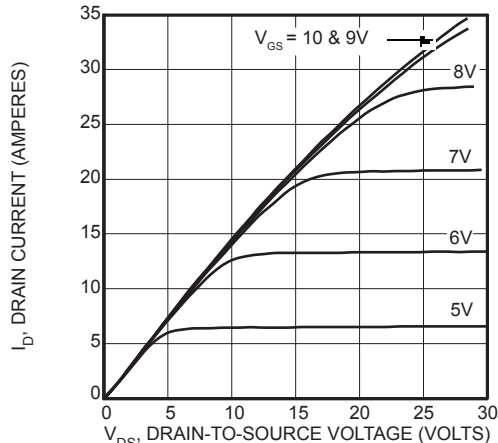

Figure 5, Typical Output Characteristics

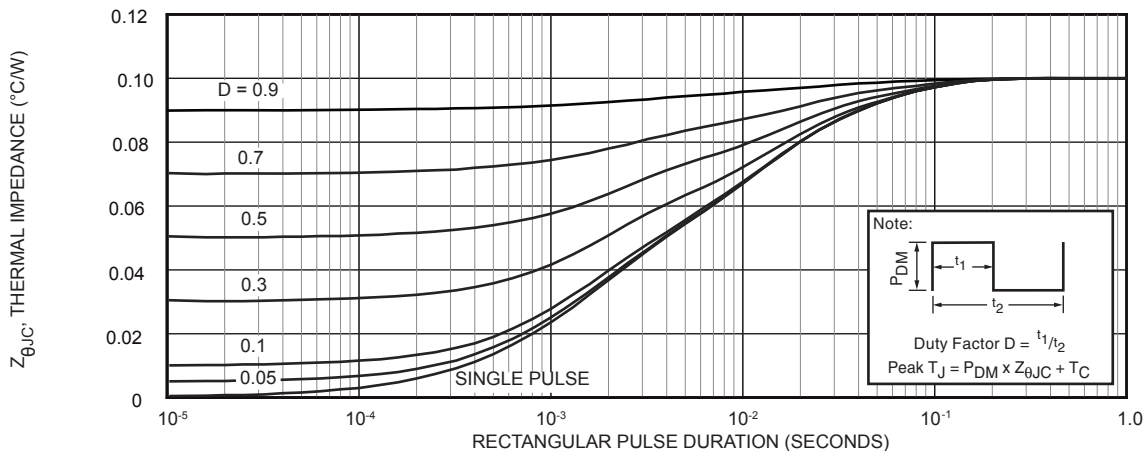

Figure 6, Maximum Effective Transient Thermal Impedance, Junction-to-Case vs. Pulse Duration

TYPICAL LARGE SIGNAL
INPUT - OUTPUT
IMPEDANCE
CHARACTERISTICS

F (MHz)	Z _{in} (Ω)	Z _{OL} (Ω)
2.0	5.4 - j 9.6	46 - j 10.5
13.5	0.30 - j 1.2	16.4 - j 23
27	0.26 + j .58	4.9 - j 14.6
40	0.36 + j 1.6	2.3 - j 10.3

Z_{in} - Gate shunted with 25Ω
Z_{OL} - Conjugate of optimum
load for 750 Watts output
I_{DQ} = 100mA
V_{dd} = 300V

Thermal Considerations and Package Mounting:

The rated 1500W power dissipation is only available when the package mounting surface is at 25°C and the junction temperature is 175°C. The thermal resistance between junctions and case mounting surface is 0.10°C/W. When installed, an additional thermal impedance of 0.06°C/W between the package base and the mounting surface is smooth and flat. Thermal joint compound must be used to reduce the effects of small surface irregularities. The heatsink should incorporate a copper heat spreader to obtain best results.

The package is designed to be clamped to a heatsink. A clamped joint maintains the required mounting pressure while allowing for thermal expansion of both the device and the heat sink. A simple clamp, and two 6-32 (M3.5) screws can provide the minimum 125 lb. required mounting force. T=4-6 in-lb. Please refer to App Note 1802 "Mounting Instructions for Flangeless Packages."

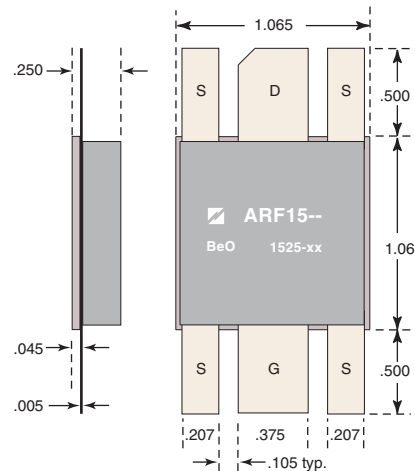
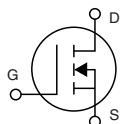
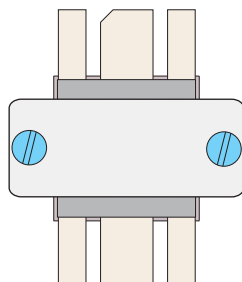
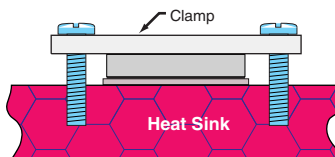

HAZARDOUS MATERIAL WARNING

The ceramic portion of the device between leads and mounting surface is beryllium oxide, BeO. Beryllium oxide dust is toxic when inhaled. Care must be taken during handling and mounting to avoid damage to this area. These devices must never be thrown away with general industrial or domestic waste.

ARF1505 -- 27.12 MHz Test Circuit

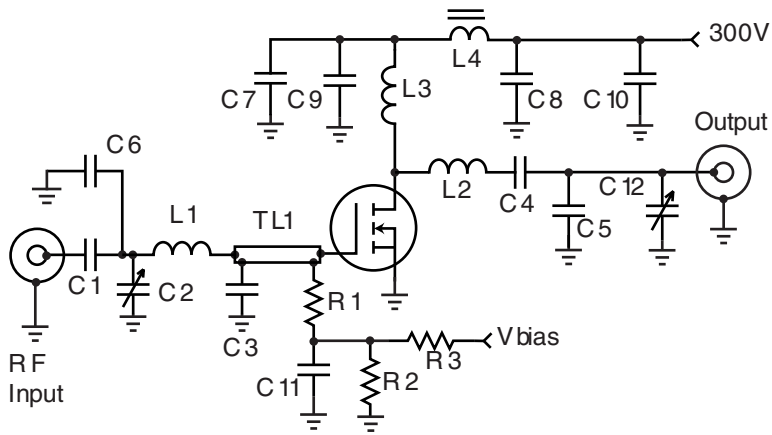

- C1, C7, C8, C11 .047mF 500V cerami disc
- C2, C12 Arco 465 75-380pF mica trimmer
- C3 2x 4700pF ATC 700B
- C4, C9-C10 8200pF 500V NPO ceramic
- C5 200pF ATC 100E
- C6 150pF ATC 700B
- L1 90nH 4t # 18 0.25" d .25" l
- L2 200nH - 3t # 8 1" dia 1" l
- L3 6μH - 22t # 24 enam 0.5" dia
- L4 500nH 2t on 850μ .5" bead
- R1-R3 1KΩ 1/4W
- TL1 .112" x 1" (50Ω) Stripline

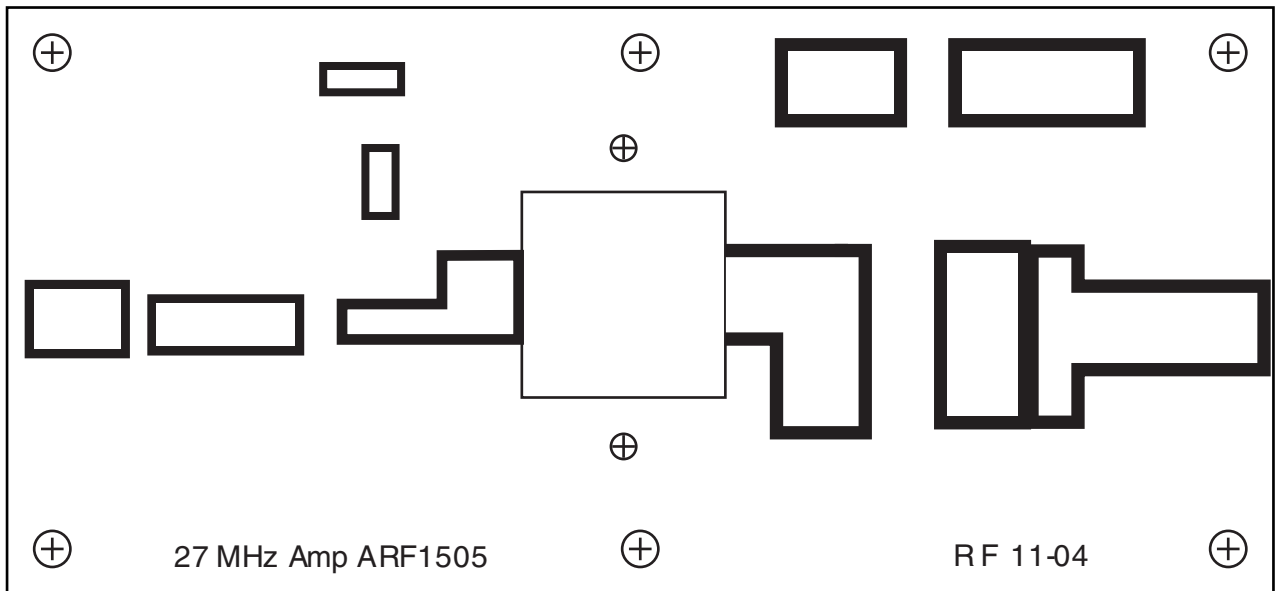
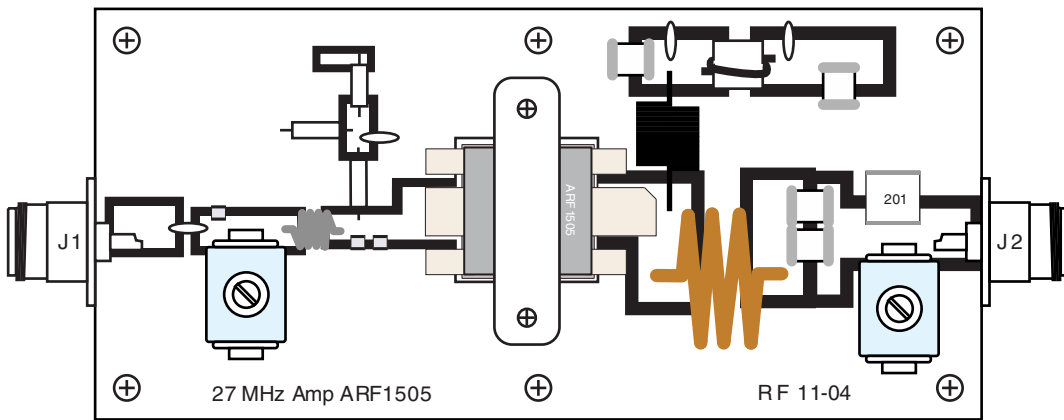

Данный компонент на территории Российской Федерации

Вы можете приобрести в компании MosChip.

Для оперативного оформления запроса Вам необходимо перейти по данной ссылке:

<http://moschip.ru/get-element>

Вы можете разместить у нас заказ для любого Вашего проекта, будь то серийное производство или разработка единичного прибора.

В нашем ассортименте представлены ведущие мировые производители активных и пассивных электронных компонентов.

Нашей специализацией является поставка электронной компонентной базы двойного назначения, продукции таких производителей как XILINX, Intel (ex.ALTERA), Vicor, Microchip, Texas Instruments, Analog Devices, Mini-Circuits, Amphenol, Glenair.

Сотрудничество с глобальными дистрибьюторами электронных компонентов, предоставляет возможность заказывать и получать с международных складов практически любой перечень компонентов в оптимальные для Вас сроки.

На всех этапах разработки и производства наши партнеры могут получить квалифицированную поддержку опытных инженеров.

Система менеджмента качества компании отвечает требованиям в соответствии с ГОСТ Р ИСО 9001, ГОСТ РВ 0015-002 и ЭС РД 009

Офис по работе с юридическими лицами:

105318, г.Москва, ул.Щербаковская д.3, офис 1107, 1118, ДЦ «Щербаковский»

Телефон: +7 495 668-12-70 (многоканальный)

Факс: +7 495 668-12-70 (доб.304)

E-mail: info@moschip.ru

Skype отдела продаж:

moschip.ru

moschip.ru_4

moschip.ru_6

moschip.ru_9