



TO-92S



Pin Definition:

1. V_{CC}
2. GND
3. Output

SOT-23



Pin Definition:

1. V_{CC}
2. Output
3. GND

Description

TSH190, Hall-Effect sensor, designed for electronic commutation of brush-less DC motor applications. The device includes an on-chip Hall voltage generator for magnetic sensing, a comparator that amplifies the Hall Voltage, and a Schmitt trigger to provide switching hysteresis for noise rejection, open collector output. An internal band gap regulator is used to provide temperature compensated supply voltage for internal circuits and allows a wide operating supply range. The device is identical except for magnetic switch points. A south pole of sufficient strength will turn the output on. The North Pole is necessary to turn the output off. An on-board regulator permits operation with supply voltages of 4V to 30 V.

Features

- Optimized for BLDC motor applications
- High Peak Voltage of 65V
- 100% tested at 125°C
- Temperature compensation function

Ordering Information

Part No.	Package	Packing
TSH190CT B0G	TO-92S	1Kpcs / Bulk Bag
TSH190CX RFG	SOT-23	3Kpcs / 7" Reel

Note: "G" denote for Halogen Free Product

Application

- High temperature Fan motor
- 3 phase BLDC motor application
- Fan motor application
- Speed sensing
- Revolution counting
- E-Bike

Absolute Maximum Rating (T_a = 25°C unless otherwise noted)

Characteristics	Limit	Value	Unit
Supply voltage	V _{CC}	65	V
Output Voltage	V _{OUT}	65	V
Reverse voltage	V _{CC/OUT}	-32	V
Magnetic flux density		Unlimited	Gauss
Output current	I _{OUT}	25	mA
Operating Temperature Range	T _{OPR}	-40 to +125	°C
Storage temperature range	T _{STG}	-55 to +150	°C
Maximum Junction Temp	T _J	150	°C
Thermal Resistance - Junction to Ambient	TO-92S	θ _{JA}	°C/W
	SOT-23		
Thermal Resistance - Junction to Case	TO-92S	θ _{JC}	°C/W
	SOT-23		
Package Power Dissipation	TO-92S	P _D	mW
	SOT-23		

Note: Do not apply reverse voltage to V_{CC} and V_{OUT} Pin, It may be caused for Miss function or damaged device.

Block Diagram

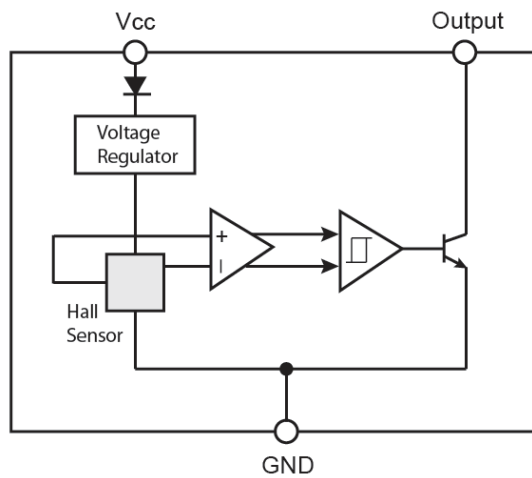

Typical Application Circuit

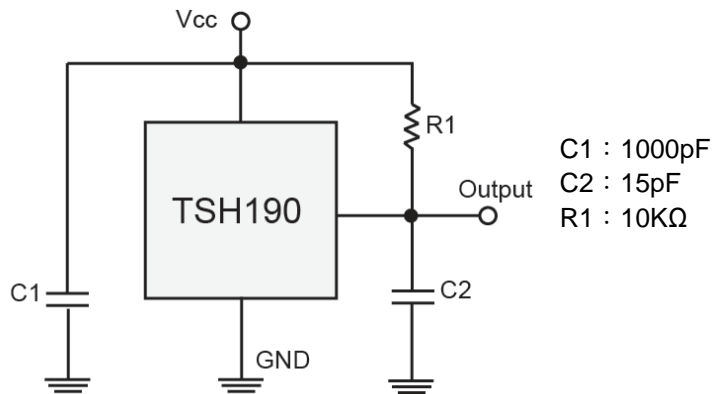

Electrical Specifications (DC Operating Parameters : $T_A=+25^{\circ}\text{C}$, $V_{CC}=12\text{V}$)

Parameters	Test Conditions	Min	Typ	Max	Units
Supply Voltage	Operating	4	--	30	V
Supply Current	$B < B_{OP}$	--	3	8	mA
Output Saturation Voltage	$I_{OUT} = 5\text{mA}$, $B > B_{OP}$	--	--	500	mV
Output Leakage Current	I_{OFF} $B < B_{RP}$, $V_{OUT} = 24\text{V}$	--	--	10	uA
Output Rise Time	$R_L = 820\Omega$, $C_L = 20\text{pF}$	--	1.5	--	uS
Output Fall Time	$R_L = 820\Omega$; $C_L = 20\text{pF}$	--	1.5	--	uS

Magnetic Specifications

Parameters	Test Conditions	Min	Typ	Max	Units
Operate Point		10	--	110	Gauss
Release Point		-110	--	-10	Gauss
Hysteresis		--	100	--	Gauss

Note: 1G (Gauss) = 0.1mT (millitesta)

Output Behavior versus Magnetic Pole

DC Operating Parameters: $T_A = -40$ to 125°C , $V_{CC} = 4$ to 30V

Parameter	Package	Test condition	OUT
North pole	TO-92S	$B > B_{OP}$	Open
South pole	TO-92S	$B < B_{RP}$	Low
North pole	SOT-23	$B > B_{OP}$	Low
South pole	SOT-23	$B < B_{RP}$	Open

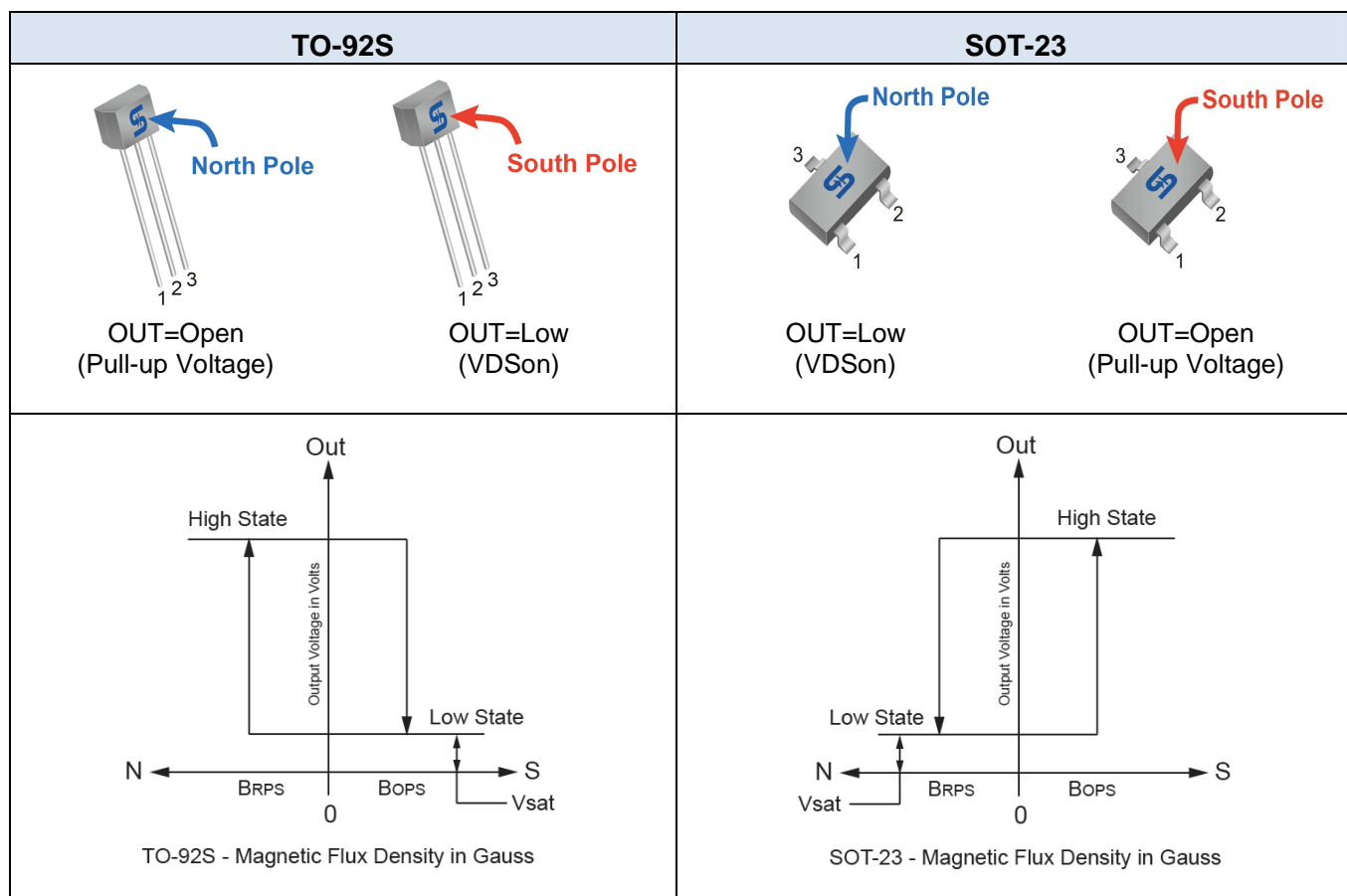

Characteristic Performance

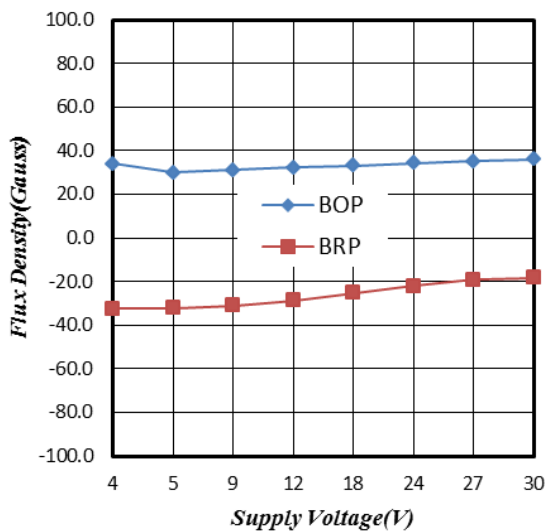

Figure 1. Supply Voltage vs. Flux Density

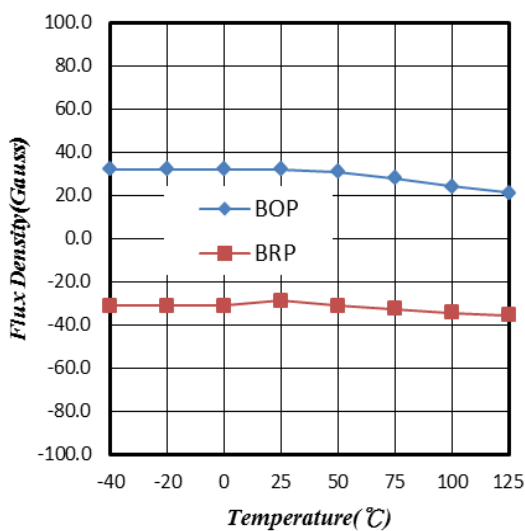

Figure 2. Temperature vs. Flux Density

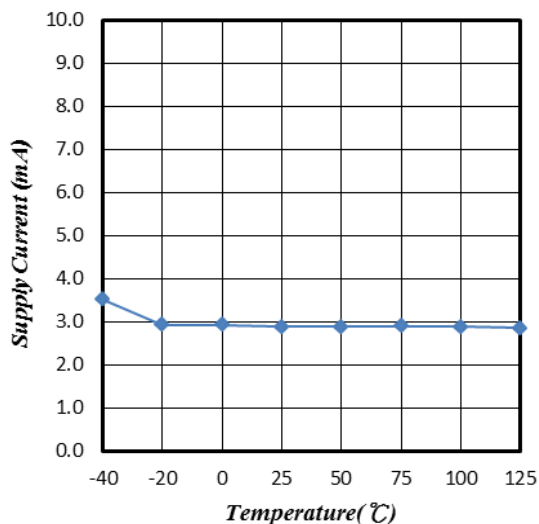

Figure 3. Supply Current vs. Temperature

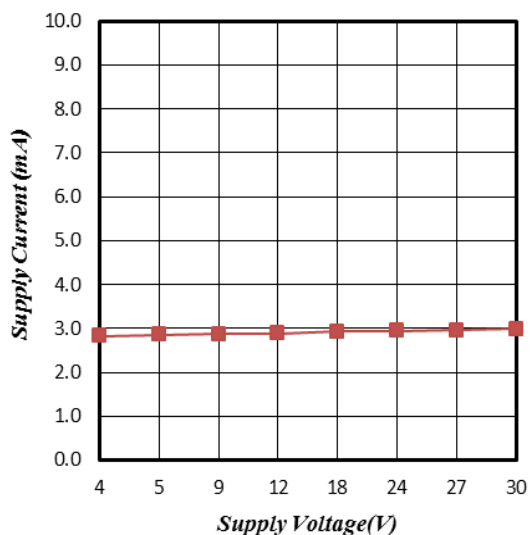

Figure 4. Supply Current vs. Supply Voltage

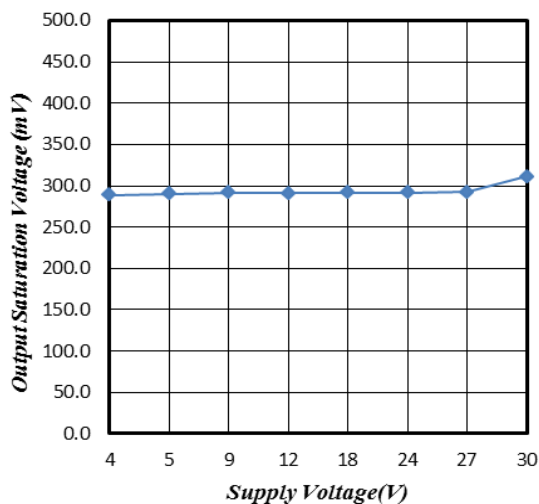

Figure 5. Supply Voltage vs. Saturation Voltage

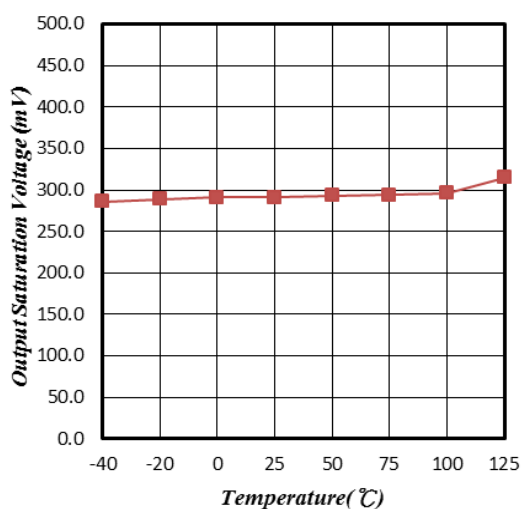

Figure 6. Saturation Voltage vs. Temperature

Characteristic Performance

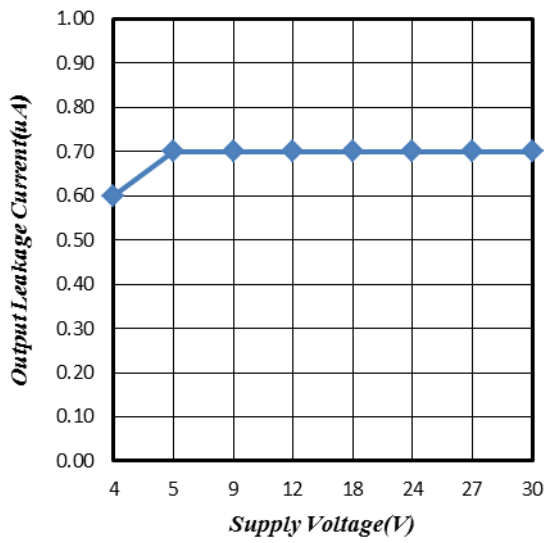

Figure 7. Supply Voltage vs. Leakage Current

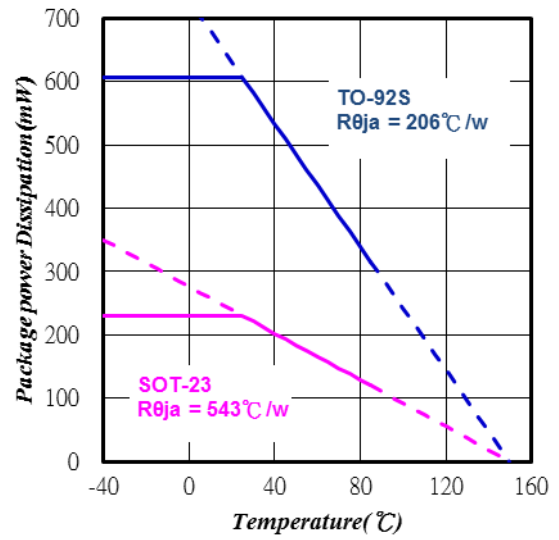
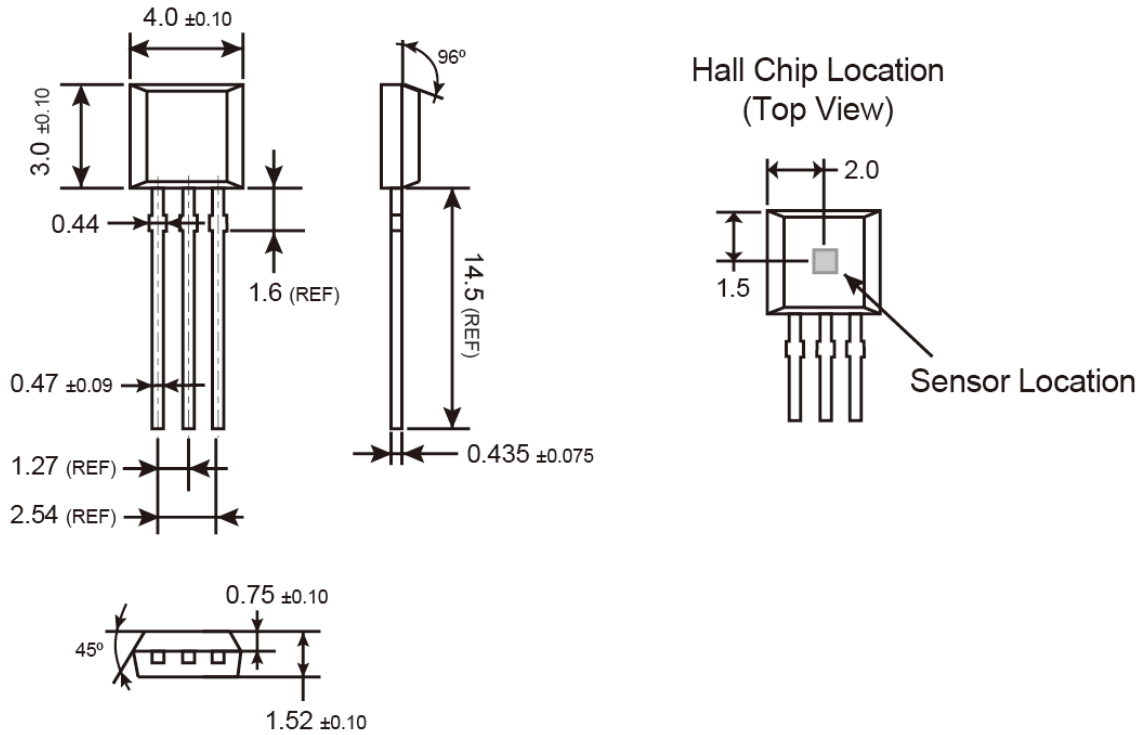

Figure 8. Temperature vs. Power Dissipation

TO-92S Mechanical Drawing



Unit: Millimeters

Marking Diagram

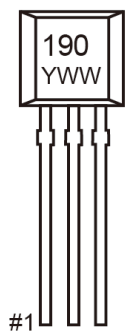

190 = Device Code
Y = Year Code
WW = Week Code (01~52)

SOT-23 Mechanical Drawing

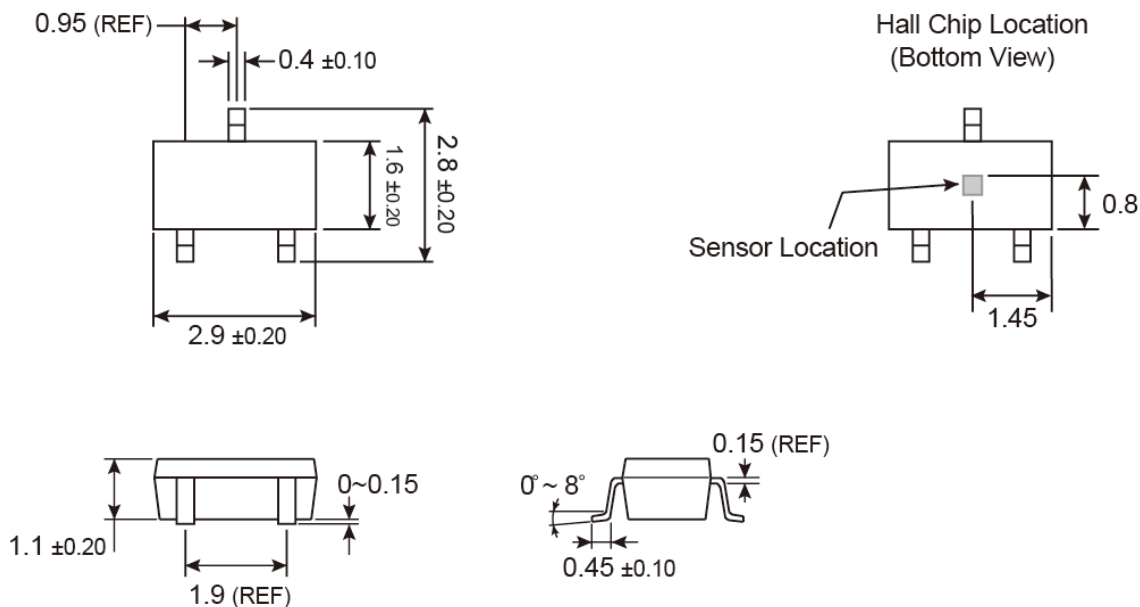

Unit: Millimeters

Marking Diagram

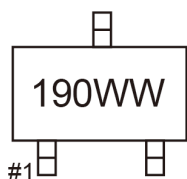

190 = Device Code
WW = Week Code Table

week	1	2	3	4	5	6	7	8	9	10	11	12	13
code	OA	OB	OC	OD	OE	OF	OG	OH	OI	OJ	OK	OL	OM
week	14	15	16	17	18	19	20	21	22	23	24	25	26
code	ON	OO	OP	OQ	OR	OS	OT	OU	OV	OW	OX	OY	OZ
week	27	28	29	30	31	32	33	34	35	36	37	38	39
code	PA	PB	PC	PD	PE	PF	PG	PH	PI	PJ	PK	PL	PM
week	40	41	42	43	44	45	46	47	48	49	50	51	52
code	PN	PO	PP	PQ	PR	PS	PT	PU	PV	PW	PX	PY	PZ

Notice

Specifications of the products displayed herein are subject to change without notice. TSC or anyone on its behalf, assumes no responsibility or liability for any errors or inaccuracies.

Information contained herein is intended to provide a product description only. No license, express or implied, to any intellectual property rights is granted by this document. Except as provided in TSC's terms and conditions of sale for such products, TSC assumes no liability whatsoever, and disclaims any express or implied warranty, relating to sale and/or use of TSC products including liability or warranties relating to fitness for a particular purpose, merchantability, or infringement of any patent, copyright, or other intellectual property right.

The products shown herein are not designed for use in medical, life-saving, or life-sustaining applications. Customers using or selling these products for use in such applications do so at their own risk and agree to fully indemnify TSC for any damages resulting from such improper use or sale.

Данный компонент на территории Российской Федерации

Вы можете приобрести в компании MosChip.

Для оперативного оформления запроса Вам необходимо перейти по данной ссылке:

<http://moschip.ru/get-element>

Вы можете разместить у нас заказ для любого Вашего проекта, будь то серийное производство или разработка единичного прибора.

В нашем ассортименте представлены ведущие мировые производители активных и пассивных электронных компонентов.

Нашей специализацией является поставка электронной компонентной базы двойного назначения, продукции таких производителей как XILINX, Intel (ex.ALTERA), Vicor, Microchip, Texas Instruments, Analog Devices, Mini-Circuits, Amphenol, Glenair.

Сотрудничество с глобальными дистрибьюторами электронных компонентов, предоставляет возможность заказывать и получать с международных складов практически любой перечень компонентов в оптимальные для Вас сроки.

На всех этапах разработки и производства наши партнеры могут получить квалифицированную поддержку опытных инженеров.

Система менеджмента качества компании отвечает требованиям в соответствии с ГОСТ Р ИСО 9001, ГОСТ РВ 0015-002 и ЭС РД 009

Офис по работе с юридическими лицами:

105318, г.Москва, ул.Щербаковская д.3, офис 1107, 1118, ДЦ «Щербаковский»

Телефон: +7 495 668-12-70 (многоканальный)

Факс: +7 495 668-12-70 (доб.304)

E-mail: info@moschip.ru

Skype отдела продаж:

moschip.ru

moschip.ru_4

moschip.ru_6

moschip.ru_9