

## Sensor/Actuator cable - SAC-5P-MINMR/0,6-440/MINFR PWR - 1443860

Please be informed that the data shown in this PDF Document is generated from our Online Catalog. Please find the complete data in the user's documentation. Our General Terms of Use for Downloads are valid (<http://download.phoenixcontact.com>)



Power cable, 5-pos., gray PUR/PVC, 1.5 mm<sup>2</sup>, angled 7/8" 16UNF male plug to angled 7/8" 16UNF female plug, length: 0.6 m

### Product Features

- ✓ Easy and safe: 100% electrically tested plug-in components
- ✓ Robust connectors in size 7/8"-16UNF
- ✓ High-performance: connectors and cables with a large conductor cross section for power supply



### Key commercial data

|                      |          |
|----------------------|----------|
| Packing unit         | 1 1      |
| Custom tariff number | 85444290 |
| Country of origin    | Germany  |

### Technical data

#### Dimensions

|                 |       |
|-----------------|-------|
| Length of cable | 0.6 m |
|-----------------|-------|

#### Ambient conditions

|                                 |                                  |
|---------------------------------|----------------------------------|
| Ambient temperature (operation) | -40 °C ... 90 °C (Plug / socket) |
| Degree of protection            | IP65                             |
|                                 | IP67                             |
|                                 | IP68                             |

#### General

|                       |         |
|-----------------------|---------|
| Rated current at 40°C | 10 A    |
| Rated voltage         | 600 V   |
| Number of positions   | 5       |
| Contact resistance    | ≤ 5 mΩ  |
| Insulation resistance | ≥ 10 MΩ |

## Sensor/Actuator cable - SAC-5P-MINMR/0,6-440/MINFR PWR - 1443860

### Technical data

#### General

|   |                  |
|---|------------------|
| Coding  | A - standard     |
| Status display  | No               |
| Surge voltage category  | II               |
| Pollution degree  | 3                |
| Structure of individual litz in acc. with VDE 0295 / smallest wire diameter | VDE 0295 class 5 |
| Insertion/withdrawal cycles   | 100              |

#### Material

|   |                              |
|---|------------------------------|
| Inflammability class according to UL 94 | HB                           |
| Contact material                        | CuZn                         |
| Contact surface material                | AU                           |
| Contact carrier material                | PA 66                        |
| Material of grip body                   | TPU                          |
| Material, knurls                        | Zinc die-cast, nickel-plated |

#### Cable

|   |  |
|---|--|
| Cable type                                    | PUR/PVC gray                                     |
| Cable abbreviation                            | 11Y-JZ   |
| AWG signal line                               | 16   |
| Wire colors                                   | Black 1, black 2, black 3, black 4, green/yellow |
| Overall twist                                 | 5 cores, twisted                                 |
| External sheath, color                        | Gray RAL 7001                                    |
| External cable diameter                       | 9.70 mm  |
| Smallest bending radius, fixed installation   | 73 mm  |
| Smallest bending radius, movable installation | 145.5 mm   |
| Cable weight                                  | 140 kg/km  |
| Outer sheath, material                        | PUR  |
| Conductor material                            | Bare Cu litz wires                               |
| Flame resistance                              | According to UL VW1                              |
|   | IEC 60332-1-2                                    |
| Ambient temperature (operation)               | -40 °C ... 90 °C (cable, fixed installation)     |
|   | 5 °C ... 90 °C (cable, flexible installation)    |

### Classifications

#### eCl@ss

|            |          |
|------------|----------|
| eCl@ss 4.0 | 27060306 |
| eCl@ss 4.1 | 27060306 |

# Sensor/Actuator cable - SAC-5P-MINMR/0,6-440/MINFR PWR - 1443860

## Classifications

### eCl@ss

|            |          |
|------------|----------|
| eCl@ss 5.0 | 27061801 |
| eCl@ss 5.1 | 27061801 |
| eCl@ss 6.0 | 27279218 |
| eCl@ss 7.0 | 27279218 |
| eCl@ss 8.0 | 27279218 |

### ETIM

|          |          |
|----------|----------|
| ETIM 2.0 | EC000830 |
| ETIM 3.0 | EC001855 |
| ETIM 4.0 | EC001855 |
| ETIM 5.0 | EC001855 |

### UNSPSC

|               |          |
|---------------|----------|
| UNSPSC 6.01   | 31251501 |
| UNSPSC 7.0901 | 31251501 |
| UNSPSC 11     | 31251501 |
| UNSPSC 12.01  | 31251501 |
| UNSPSC 13.2   | 31251501 |

## Approvals

### Approvals

---

#### Approvals

UL Listed / cUL Listed / GOST / cULus Listed

---

#### Ex Approvals

---

#### Approvals submitted

---

#### Approval details

# Sensor/Actuator cable - SAC-5P-MINMR/0,6-440/MINFR PWR - 1443860

## Approvals

|                    |       |
|--------------------|-------|
| UL Listed          |       |
|                    |       |
| Nominal current IN | 10 A  |
| Nominal voltage UN | 600 V |

|                    |       |
|--------------------|-------|
| cUL Listed         |       |
|                    |       |
| Nominal current IN | 10 A  |
| Nominal voltage UN | 600 V |

|      |  |
|------|--|
| GOST |  |
|------|--|

|              |  |
|--------------|--|
| cULus Listed |  |
|--------------|--|

## Accessories

### Accessories

#### Conductor marking

Insert label - PABA WH/15 - 1013151



Insert label, Strip, white, Unlabeled, Can be labeled with: Plotter, Mounting type: Thread on, Cable diameter: 0.6-50 mm, Lettering field: 15 x 4 mm

## Sensor/Actuator cable - SAC-5P-MINMR/0,6-440/MINFR PWR - 1443860

### Accessories

Insert label - PABA YE/15 - 1013698



Insert label, Strip, yellow, Unlabeled, Can be labeled with: Plotter, Mounting type: Thread on, Cable diameter: 0.6-50 mm, Lettering field: 15 x 4 mm

---

Insert label - PABA RD/15 - 1013944



Insert label, Strip, red, Unlabeled, Can be labeled with: Plotter, Mounting type: Thread on, Cable diameter: 0.6-50 mm, Lettering field: 15 x 4 mm

---

### Marker carrier cable

Conductor marker carrier - PATO 2/15 - 1013122



Conductor marker carrier, transparent, Unlabeled, Mounting type: Clip on, Cable diameter: 2.8-4.4 mm, Lettering field: 4 x 15 mm

---

Conductor marker carrier - PATO 3/15 - 1013135



Conductor marker carrier, transparent, Unlabeled, Mounting type: Clip on, Cable diameter: 4.4-6.7 mm, Lettering field: 4 x 15 mm

---

Conductor marker carrier - PATO 4/15 - 1013148



Conductor marker carrier, transparent, Unlabeled, Mounting type: Clip on, Cable diameter: 6.7-10 mm, Lettering field: 4 x 15 mm

---

## Sensor/Actuator cable - SAC-5P-MINMR/0,6-440/MINFR PWR - 1443860

### Accessories

#### Marker pen

Marker pen - B-STIFT - 1051993



Marker pen, for manual labeling of unprinted Zack strips, smear-proof and waterproof, line thickness 0.5 mm

---

#### Protective cap

Sealing cap - PROT-MINFS-PA-CHAIN - 1430912

7/8" sealing cap made of plastic with fixing band, for sensor cables, for 7/8" connectors



Screw plug - PROT-MINMS-PA-CHAIN - 1430925

7/8" sealing cap made of plastic with fixing band, for sensor cables, for 7/8" sockets



#### Screwdriver tools

Adapter insert - TSD-M SAC-BIT ADAPTER - 1212600



Adapter bit for TSD-M...torque tools, E6.3-1/4" drive with 4 mm hexagon to accommodate SAC bits

---

# Sensor/Actuator cable - SAC-5P-MINMR/0,6-440/MINFR PWR - 1443860

## Accessories

Adapter - SAC BIT MIN-D25 - 1212512



SAC nut, for assembling 7/8" connectors, with 4 mm hexagonal drive

---

## Torque tool

Torque screwdriver - TSD 08 SAC - 1212597



Torque screw driver with preset torque of 0.8 Nm, with 4 mm hexagon for accommodating SAC bits, two-component handle with non-slip grip

---

Torque screwdriver - TSD-M 1,2NM - 1212224



Torque screw driver, accuracy as per EN ISO 6789 standard, adjustable from 0.3 - 1.2 Nm

---

## Drawings

Schematic diagram



Pin assignment, plug, 7/8"-16UNF, 5-pos., view of male side

Schematic diagram

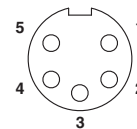

Pin assignment, socket, 7/8"-16UNF, 5-pos., view of female side

# Sensor/Actuator cable - SAC-5P-MINMR/0,6-440/MINFR PWR - 1443860

Cable cross section

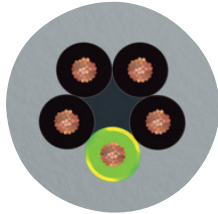

PUR/PVC gray [440]

Dimensioned drawing

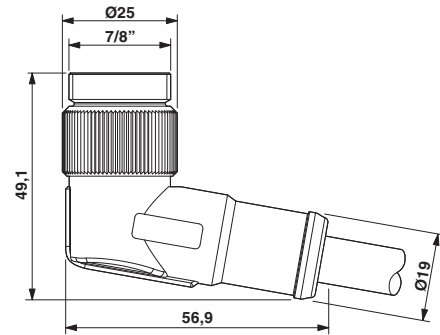

7/8"-16UNF plug, angled

Dimensioned drawing

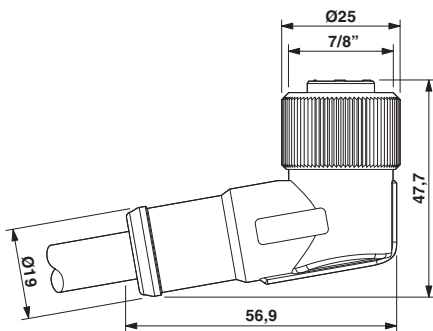

7/8"-16UNF socket, angled

Circuit diagram



Contact assignment of the 7/8" connector and the 7/8" socket



## Данный компонент на территории Российской Федерации

### Вы можете приобрести в компании MosChip.

Для оперативного оформления запроса Вам необходимо перейти по данной ссылке:

<http://moschip.ru/get-element>

Вы можете разместить у нас заказ для любого Вашего проекта, будь то серийное производство или разработка единичного прибора.

В нашем ассортименте представлены ведущие мировые производители активных и пассивных электронных компонентов.

Нашей специализацией является поставка электронной компонентной базы двойного назначения, продукции таких производителей как XILINX, Intel (ex.ALTERA), Vicor, Microchip, Texas Instruments, Analog Devices, Mini-Circuits, Amphenol, Glenair.

Сотрудничество с глобальными дистрибьюторами электронных компонентов, предоставляет возможность заказывать и получать с международных складов практически любой перечень компонентов в оптимальные для Вас сроки.

На всех этапах разработки и производства наши партнеры могут получить квалифицированную поддержку опытных инженеров.

Система менеджмента качества компании отвечает требованиям в соответствии с ГОСТ Р ИСО 9001, ГОСТ РВ 0015-002 и ЭС РД 009

### Офис по работе с юридическими лицами:

105318, г.Москва, ул.Щербаковская д.3, офис 1107, 1118, ДЦ «Щербаковский»

Телефон: +7 495 668-12-70 (многоканальный)

Факс: +7 495 668-12-70 (доб.304)

E-mail: [info@moschip.ru](mailto:info@moschip.ru)

Skype отдела продаж:

moschip.ru

moschip.ru\_4

moschip.ru\_6

moschip.ru\_9