

Reduce inventory levels and cost by stocking actuators and base switches separately.

**Contura II, III, IV, V, X, XI, XII Base switches separately:** specify V with code selections 2-8 in the ordering schemes.

**Contura II, III, IV, V Actuator only:** VV with code A or C for selection 9, & with selections 10-14 in the ordering schemes.

**Panel Seal: VPS**

**Contura II, III, IV, V Actuator only:** VV with code A, C, E, G or P for selection 9 & with selections 10-14 in the ordering schemes.

**Contura X, XI, XII actuators with lenses separately:** VV with code selections 9-14 in the ordering schemes.

### Contura X & XI actuators without lenses separately:

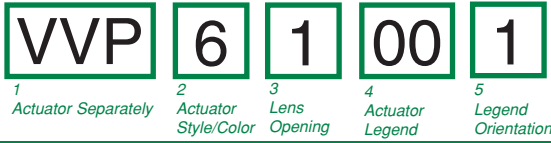

<b>1 CONTURA X &amp; XI ACTUATOR SEPARATELY</b> VVP								
<b>2 ACTUATOR STYLE &amp; COLOR</b>								
	Black	Gray	White	Red				
Contura X	1	2	3	4				
Contura XI	6	7	8	9				
<b>3 LENS OPENING FOR<sup>1</sup></b>								
1	One bar lens	4	Two Square lens					
2	One bar lenses	5	Square lens on top/ bar lens on bottom (Contura X only)					
3	One Square lens							
<b>4 ACTUATOR LENS OR BODY LEGEND</b>								
00 - No Legend this location								
11	ON	12	OFF	13	I	14	O	
	OFF		ON		O		I	
15	O	16	O	17	O	18	I	O
	F		N		N		F	
	F		F		F			
For additional legend options & codes, see page 69 of this catalog								
<b>5 LEGEND ORIENTATION<sup>2</sup></b>								
0	No legend							
1	Orientation 1							
2	Orientation 2							
3	Orientation 3							
4	Orientation 4							

### Contura X, XI & XII top piece of 2-piece lens separately:

<b>VVT 1</b>		<b>1 TOP OF LENS SEPARATELY</b> VVT
1	2	
Lens Separately	Color	
<b>2 COLOR</b>		
1	2	3
Clear	Smoke	White

### Contura X, XI & XII actuator lens assembly:

actuator stem      top lens

posts mount toward actuator stem      bottom lens

two piece lens assembly

1 piece lens/bar lens are positioned the same as bottom lens for assembly, minus the top lens. Lenses snap in from bottom.

- NOTES**
- 1 If actuator lens opening for 2 bar or 2 square lenses, legend orientation 0, 1, or 2 must be chosen.
  - 2 Center of actuator marking not available for Contura XII.
  - 3 Legend is not available for bar style lens.
  - 4 Not recommended with neon lamps.
  - 5 Must also order top piece of 2 piece square lens separately.

### Contura XII actuators without lenses separately:

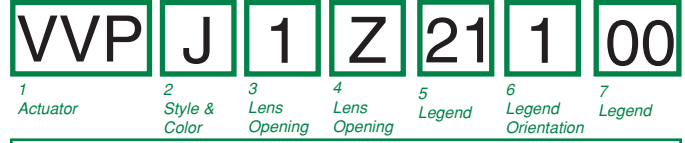

<b>1 CONTURA XII ACTUATOR SEPARATELY</b> VVP										
<b>2 ACTUATOR STYLE &amp; COLOR</b>										
J	K	N	M							
Black	Gray	White	Red							
<b>3,4 LENS OPENING FOR</b>										
Z	1	2								
No lens	Bar lens	Square lens								
<b>5, 7 LENS OR BODY LEGEND<sup>2</sup></b>										
00	no legend	21	OFF	22	ON	23	O	24	I	
		25	O	26	O	27	O	28	I	
			F		F		N			
For additional legend options & codes, see page 69 of this catalog.										
<b>6 LEGEND ORIENTATION<sup>3</sup></b>										
0	No legend									
1	Orientation 1									
2	Orientation 2									

### Contura X, XI & XII actuator lens assembly separately:

<b>VVL 2 1 00 0</b>								
1	2	3	4	5				
Lens Separately	Lens Style	Lens Color	Legend	Legend Orientation				
<b>1 CONTURA X, XI &amp; XII LENS SEPARATELY</b> VVL								
<b>2 LENS STYLE<sup>3</sup></b>								
1	2	3						
Bar lens	One Piece Square lens	Bottom of Two-Piece Square lens <sup>5</sup>						
<b>3 TRANSLUCENT LENS COLOR</b>								
1	2	3	4	5	6			
Clear	White	Amber	Green <sup>4</sup>	Red	Blue <sup>4</sup>			
<b>4 LENS OR BODY LEGEND<sup>2</sup></b>								
00	No legend							
21	OFF	22	ON	23	O	24	I	
	25	O	26	O	27	O	28	I
		F		N				
For additional legend options & codes, see page 69 of this catalog.								
<b>5 LEGEND ORIENTATION<sup>3</sup></b>								
0	No legend							
1	Orientation 1							
2	Orientation 2							
3	Orientation 3							
4	Orientation 4							

## Easily integrate Contura products into your system, with Contura Accessories

### Contura Connectors

Q.C. SELECTION GUIDE					
COMPANY SERIES	PART NO		WIRE RANGE		ORIENTATION
	PLAIN BRASS	TIN PLATED BRASS	AWG	MM (REF)	
PACKARD 58 SERIES	02965580		12	3.0	B
	02965471	12010601	(2)16-14	(2)1.0-2.0	
	02965470		16-14	1.0-2.0	
	02965469	06288318	20-18	.5-.8	
PACKARD METRI-PACK 630 SERIES		12084590	12	3.0	A
		12052224	12	3.0	
		12015870	16-14	1.0-2.0	
		12020035	(2)22-18	(2).5-.8	
	12015832	12015869	20-18	.5-.8	
		12052222	20-22	.35-.5	
AMP 250 SERIES FASTIN-FASTON	60253-1	60253-2	16-12 (2) 16	1.3-3 (2) 1.3	B
	42100-1	42100-2	18-14	.8-2	
	60295-1	60295-2	22-18	.3-.9	

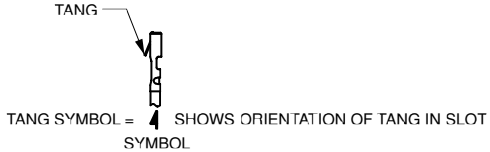

**NOTE:** Consult Delphi Packard and/or Amp or actual part numbers and availability.  
AMP is a registered trademark of AMP Inc. Harrisburg, PA  
Delphi Packard is a registered trademark of Delphi-Packard Electrical Systems Warren, Ohio

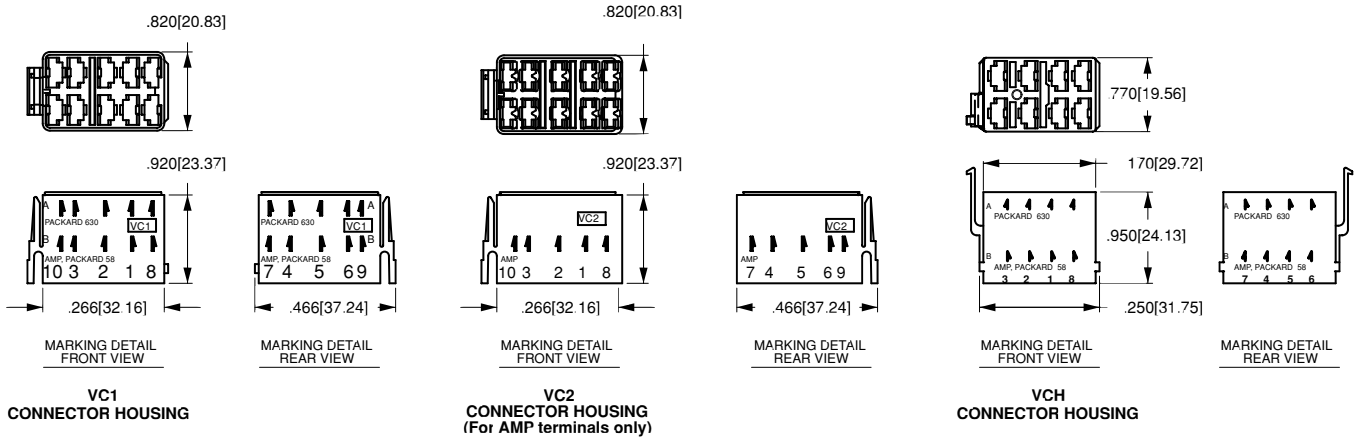

### Contura X Boot

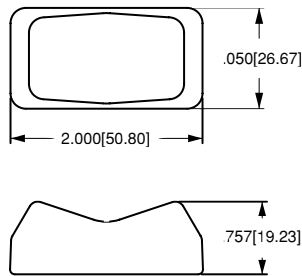

VB1-01  
CONTURA X BOOT

### Contura II, III, IV & V Actuator Removal Tool

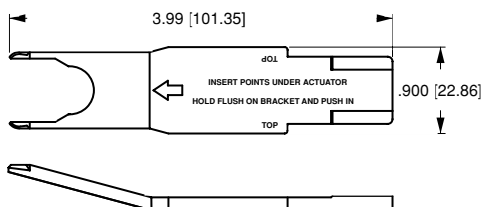

VRT  
ACTUATOR REMOVAL  
TOOL  
(For flush bracket)



## Contura Mounting Panels

### Dimensional Specifications: in. [mm]

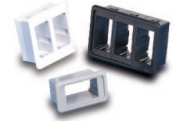
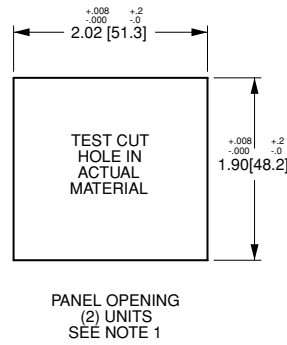
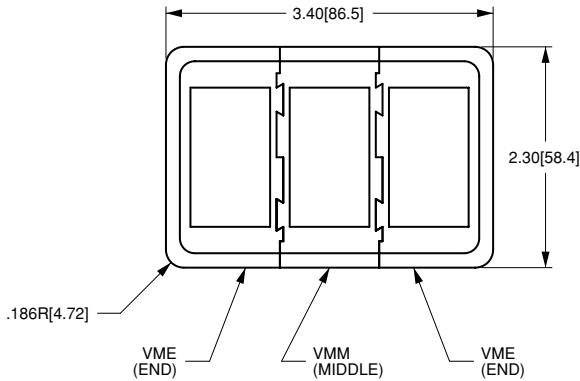

PANEL THICKNESS:  
TOLERANCE:

- .062[1.57]
- .093[2.36]
- .125[3.17]
- .187[4.75]
- .250[6.35]
- .375[9.52]

**NOTES:**

1. FOR ADDITIONAL UNITS, ADD 1.03 [26.2] PER UNIT.
2. FOR MORE THAN 2 V-SERIES SWITCHES, ADD MIDDLE SECTION.

## Contura Hole Plug

### Dimensional Specifications; in. [mm]

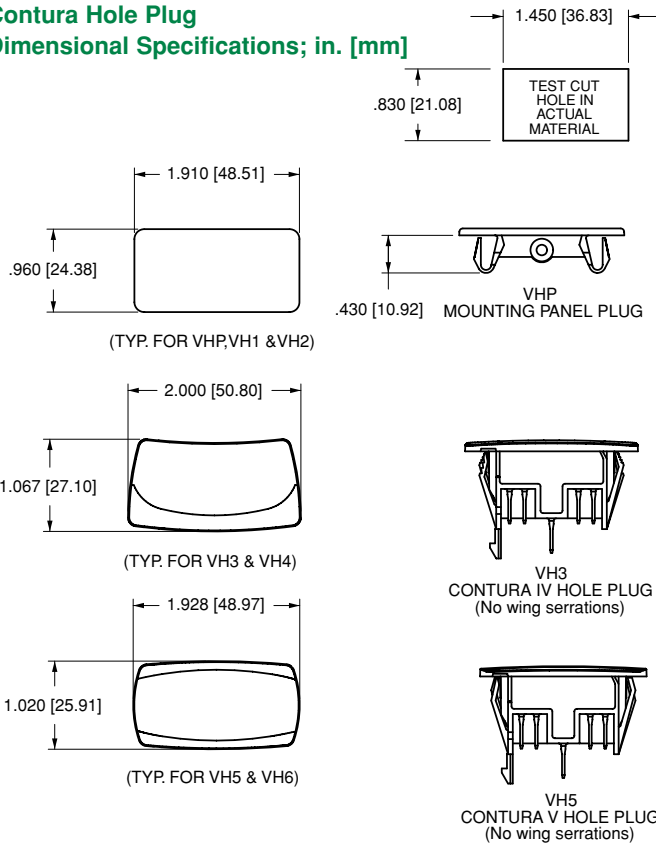

VHP  
MOUNTING PANEL PLUG

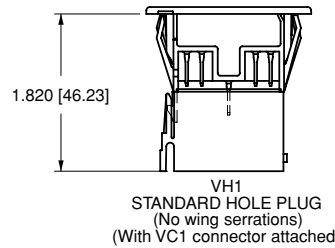

VH2  
STANDARD HOLE PLUG  
(With wing serrations)

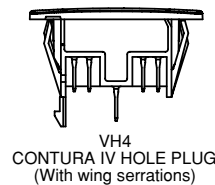
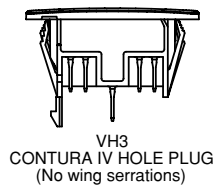

DETAIL VIEW  
VH1, VH3 & VH5  
HOLE PLUGS  
(No wing serrations  
for ease of removal)

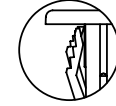
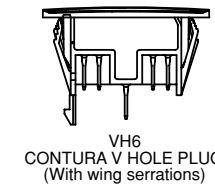
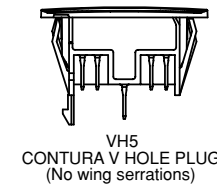

DETAIL VIEW  
VH2, VH4 & VH6  
HOLE PLUGS  
(With wing serrations)

## Additional V-Series Ratings

- |   |   |
|---|---|
| <p><b>1</b> .4VA @ 28VDC Resistive</p> <p><b>4</b> 10A 250VAC 1/2 HP, 15A 125 VAC 1/2 H, No Agency Listings</p> <p><b>5</b> 10A 250VAC 1/2 HP, 15A 125 VAC 1/2 HP, UL Recognized, CSA Certified</p> <p><b>6*</b> 15A 125VAC 1/2 HP, 12(2)A 125 VAC <math>\mu</math> T85</p> <p><b>7*</b> 15A 125VAC 1/2 HP, 12(6)A 125 VAC T85</p> <p><b>8*</b> 10A 250VAC, 15A 125VAC, 1/2 HP 125-250VAC, 12(2)A 250 VAC <math>\mu</math> T85</p> <p><b>9*</b> 10A 250VAC, 15A 125VAC, 1/2 HP 125-250VAC, 12(6)A 250 VAC T85</p> <p><b>B</b> 15A 24V</p> <p><b>C</b> 20A 18V</p> <p><b>D</b> 20A 12V</p> <p><b>E</b> 20A 14V, 10A 14VT (circuits 1, 4, A, &amp; D only)</p> <p><b>F</b> 10A 14V, 6A, 14VT (circuit G only)</p> <p><b>G</b> 20A 6V</p> <p><b>H</b> 20A 3V</p> | <p><b>L</b> 15A 125 VAC, 10A 250VAC, 1/2 HP 125-250 VAC; 6A 125 VAC L</p> <p><b>M</b> .4VA/20A 12V (combi-contact)<br/>(combination gold/silver contacts for borderline dry circuit applications)</p> <p><b>N</b> .4VA/15A 24V (combi-contact)<br/>(combination gold/silver contacts for borderline dry circuit applications)</p> |
|---|---|

**NOTES**

Consult factory to determine availability for individual circuits.  
 \* Ratings 6 - 9 are UL, CSA, VDE, DEMKO, SEMKO, NEMKO, FIMKO & BEAB certified, require terminations A or B for double pole circuits, & are not available with illumination circuits 4, 8, D, J, N, & T or with wire lead or solder lug terminations. Circuits 1, 4, A & D are not available with rating 6 & 8. Rating 7 & 9 only available with circuits 1, 4, A & D. Circuits 2, 3, 5, 7, 8, K, L are 1/2 HP 250VAC only with rating 8. Ratings 6 & 7 must specify lamp code 1 (125VAC neon). Ratings 8 & 9 must specify lamp code 2 (250VAC neon). Rating L available with circuits 1, 4, A & D only.

## Данный компонент на территории Российской Федерации

### Вы можете приобрести в компании MosChip.

Для оперативного оформления запроса Вам необходимо перейти по данной ссылке:

<http://moschip.ru/get-element>

Вы можете разместить у нас заказ для любого Вашего проекта, будь то серийное производство или разработка единичного прибора.

В нашем ассортименте представлены ведущие мировые производители активных и пассивных электронных компонентов.

Нашей специализацией является поставка электронной компонентной базы двойного назначения, продукции таких производителей как XILINX, Intel (ex.ALTERA), Vicor, Microchip, Texas Instruments, Analog Devices, Mini-Circuits, Amphenol, Glenair.

Сотрудничество с глобальными дистрибьюторами электронных компонентов, предоставляет возможность заказывать и получать с международных складов практически любой перечень компонентов в оптимальные для Вас сроки.

На всех этапах разработки и производства наши партнеры могут получить квалифицированную поддержку опытных инженеров.

Система менеджмента качества компании отвечает требованиям в соответствии с ГОСТ Р ИСО 9001, ГОСТ РВ 0015-002 и ЭС РД 009

### Офис по работе с юридическими лицами:

105318, г.Москва, ул.Щербаковская д.3, офис 1107, 1118, ДЦ «Щербаковский»

Телефон: +7 495 668-12-70 (многоканальный)

Факс: +7 495 668-12-70 (доб.304)

E-mail: [info@moschip.ru](mailto:info@moschip.ru)

Skype отдела продаж:

moschip.ru

moschip.ru\_4

moschip.ru\_6

moschip.ru\_9