

# 3M™ Pak 20 Wiremount Socket

2 mm × 2 mm for 1 mm Pitch Cable

1522 Series



- Industry standard compatible
- Mates with Pak 20 (2 mm x 2 mm) grid pin strips
- Low profile
- Preassembled covers
- Available with or without strain relief
- Available with optional centerbump polarity feature
- RoHS Compliant. See the Regulatory Information Appendix (RIA) in the “RoHS compliance” section of [www.3Mconnectors.com](http://www.3Mconnectors.com) for compliance information (RIA E1 & C1 apply)

Date Modified: July 19, 2012

TS-0523-E  
Sheet 1 of 3

## Physical

### Insulation:

Material: Glass Filled Polyester (PBT)

Flammability: UL 94V-0

Color: Gray

### Contact:

Material: Copper Alloy

### Plating:

Underplating and U-Slot: 50 -150 μ” [ 1.27-3.81 μm ] Nickel - QQ-N-290, Class 2

Wiping Area: Gold, ASTM B488-01, Class C

Wire Accommodation: 28 AWG Stranded

**Marking:** 3M Logo, Part Identification Number and Orientation Triangle

Note: The location and thickness of the contact plating is determined by the part number. Refer to ordering information.

## Electrical

**Current Rating:** 4.75 A, 1 Line Powered  
2.00 A, 6 Adjacent Lines Powered  
1.25 A, All Lines Powered

Rating Conditions: EIA-364-070 Method 2, 30°C maximum temperature rise, 20% derated. Reference appropriate 3M Product Specification for detailed current derating curves.

**Insulation Resistance:**  $> 1 \times 10^9 \Omega$  at 500 V<sub>DC</sub>

**Withstanding Voltage:** 500 V<sub>RMS</sub> at Sea Level

## Environmental

**Temperature Rating:** -55°C to +105°C

UL File No.: E68080

RoHS = Directive 2002/95/EC,  
Restriction of the Use of Certain Hazardous Substances in Electrical and Electronic Equipment

# 3M™ Pak 20 Wiremount Socket

2 mm × 2 mm for 1 mm Pitch Cable

1522 Series

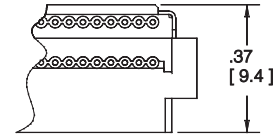
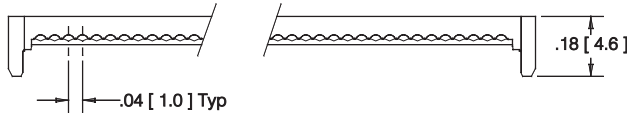
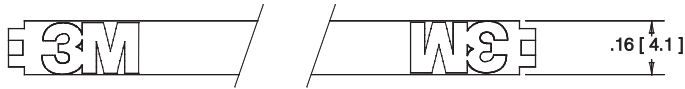

**Assembled Height with Strain Relief**

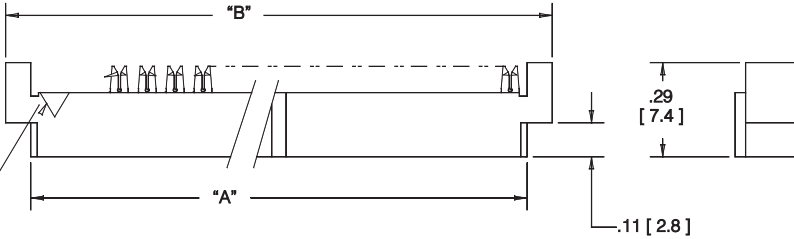

Delta Indicates Position No. 1

Optional Center Bump Polarity Feature

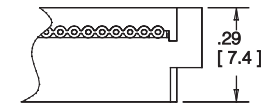
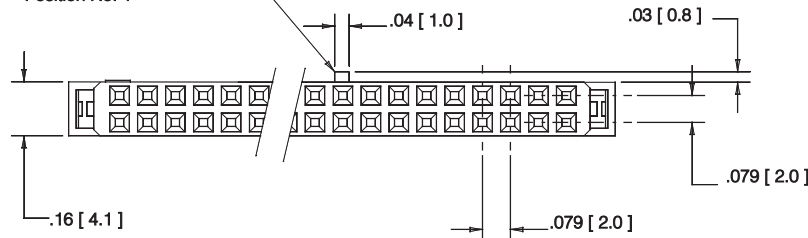

**Assembled Height without Strain Relief**

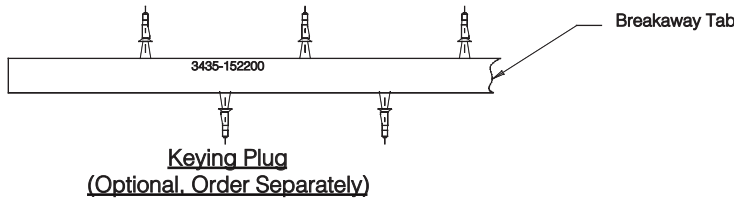

	Inch (mm)		
	Tolerance Unless Noted		
	.0	.00	.000
Inch	±.1	±.01	±.005

[ ] Dimensions for Reference only

## Ordering Information

**Socket**  
**1522XX - 0XXXXX** RIA (E1 & C1 Apply)

Contact Quantity: \_\_\_\_\_  
 (See Table 1)

- 0 = Preassembled Closed Cover, on even row side
- 1 = Preassembled Open Cover
- 2 = Preassembled Closed Cover, on odd row side

- 0 = No Polarization
- 1 = Center Bump

- Plating
- GB = 30 μ" [ 0.76 μm ] Avg Gold
- GG = 15 μ" [ 0.38 μm ] Avg Gold
- 0 = No Strain Relief
- 3 = With Strain Relief

**Strain Relief**  
**3448-1522XX**

Contact Quantity \_\_\_\_\_  
 (See Table 1)

**Gold Keying Plug**

3435-152200  
 Order Separately

Application Tools: 3640 press (or equivalent), 3443-118 locator plate, 3442-9 platen

TS-0523-E  
 Sheet 2 of 3

# 3M™ Pak 20 Wiremount Socket

2 mm × 2 mm for 1 mm Pitch Cable

1522 Series



Table 1		
Contact Quantity	Dimensions	
	A	B
10	.45 [ 11.4 ]	.59 [ 15.0 ]
12	.53 [ 13.4 ]	.67 [ 17.0 ]
20	.84 [ 21.3 ]	.99 [ 25.1 ]
26	1.08 [ 27.4 ]	1.22 [ 31.0 ]
40	1.63 [ 41.4 ]	1.77 [ 45.0 ]
44	1.79 [ 45.5 ]	1.93 [ 49.0 ]
50	2.03 [ 51.3 ]	2.17 [ 55.0 ]

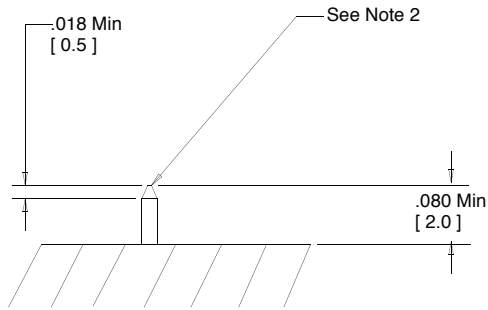

### Mating Pin Detail

Inch (mm)			
Tolerance Unless Noted			
	.0	.00	.000
Inch	± .1	± .01	± .005

[ ] Dimensions for Reference only

**Notes:**

1. Measured at tip.
2. Tapered pin tip configuration recommended.

TS-0523-E  
Sheet 3 of 3

**Important Notice**

All statements, technical information, and recommendations related to 3M's products are based on information believed to be reliable, but the accuracy or completeness is not guaranteed. Before using this product, you must evaluate it and determine if it is suitable for your intended application. You assume all risks and liability associated with such use. Any statements related to the product which are not contained in 3M's current publications, or any contrary statements contained on your purchase order shall have no force or effect unless expressly agreed upon, in writing, by an authorized officer of 3M.

**Warranty; Limited Remedy; Limited Liability.**

This product will be free from defects in material and manufacture for a period of one (1) year from the time of purchase. **3M MAKES NO OTHER WARRANTIES INCLUDING, BUT NOT LIMITED TO, ANY IMPLIED WARRANTY OF MERCHANTABILITY OR FITNESS FOR A PARTICULAR PURPOSE.** If this product is defective within the warranty period stated above, your exclusive remedy shall be, at 3M's option, to replace or repair the 3M product or refund the purchase price of the 3M product. **Except where prohibited by law, 3M will not be liable for any indirect, special, incidental or consequential loss or damage arising from this 3M product, regardless of the legal theory asserted.**

**3M Electronics Solutions Division**

6801 River Place Blvd.  
Austin, TX 78726-9000  
U.S.A.  
1-800-225-5373  
[www.3Mconnectors.com](http://www.3Mconnectors.com)

Please recycle. Printed in USA.  
© 3M 2012. All rights reserved.  
RIA-2217B-E

3M is a trademark of 3M Company.

## Данный компонент на территории Российской Федерации

### Вы можете приобрести в компании MosChip.

Для оперативного оформления запроса Вам необходимо перейти по данной ссылке:

<http://moschip.ru/get-element>

Вы можете разместить у нас заказ для любого Вашего проекта, будь то серийное производство или разработка единичного прибора.

В нашем ассортименте представлены ведущие мировые производители активных и пассивных электронных компонентов.

Нашей специализацией является поставка электронной компонентной базы двойного назначения, продукции таких производителей как XILINX, Intel (ex.ALTERA), Vicor, Microchip, Texas Instruments, Analog Devices, Mini-Circuits, Amphenol, Glenair.

Сотрудничество с глобальными дистрибьюторами электронных компонентов, предоставляет возможность заказывать и получать с международных складов практически любой перечень компонентов в оптимальные для Вас сроки.

На всех этапах разработки и производства наши партнеры могут получить квалифицированную поддержку опытных инженеров.

Система менеджмента качества компании отвечает требованиям в соответствии с ГОСТ Р ИСО 9001, ГОСТ РВ 0015-002 и ЭС РД 009

### Офис по работе с юридическими лицами:

105318, г.Москва, ул.Щербаковская д.3, офис 1107, 1118, ДЦ «Щербаковский»

Телефон: +7 495 668-12-70 (многоканальный)

Факс: +7 495 668-12-70 (доб.304)

E-mail: [info@moschip.ru](mailto:info@moschip.ru)

Skype отдела продаж:

moschip.ru

moschip.ru\_4

moschip.ru\_6

moschip.ru\_9