

SERIES 58
Single Deck, Antistatic

LOCK FEATURES

- Minimum Space Behind Panel
- 15,000 Vdc Static Protection
- 5 Tumbler-Plate Security
- In-Panel Key Recoding

SWITCH FEATURES

- Economical
- Solder Lug or PC Mount
- 36°, 45°, 60°, or 90° Throws
- 1 or 2 Poles Per Switch
- Up to 10 Positions for 1 Pole
- 200 mA for 25,000 Cycles

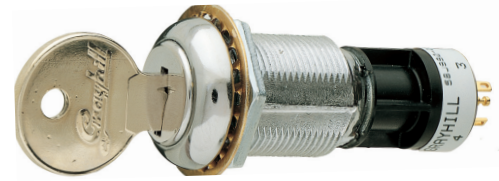

DIMENSIONS in inches (and millimeters)

Standard Style

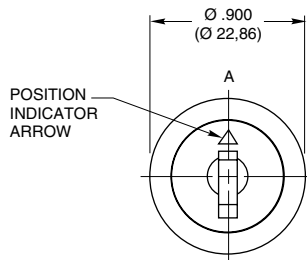

Keyslot is shown in switch position 1. Key removal position A. Key is inserted cut edge down.

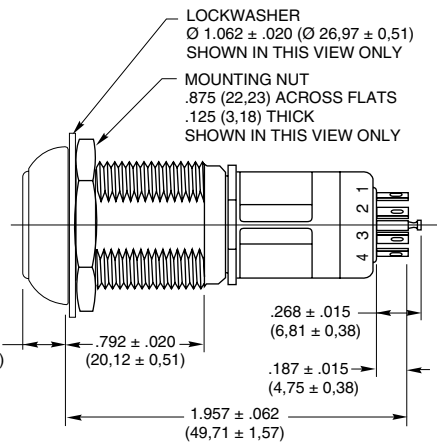

36°, 45°, 60°, or 90° Angle of Throw

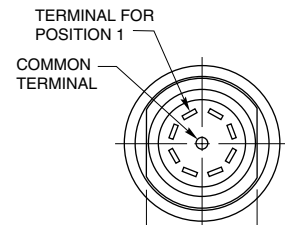

.625 ± .010 (15.88 ± 0.25)

All terminals are provided regardless of the number of active switch positions.

PC Mount Style

Dimensions not shown are the same as above.

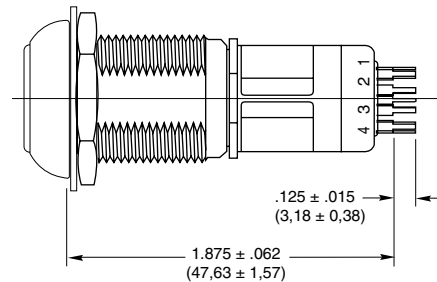
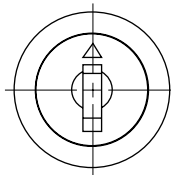

36°, 45°, 60°, or 90° Angle of Throw

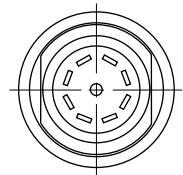

Grayhill part number and date code marked on label. Customer part number marked on request.

TERMINAL DETAIL

Solder Lug

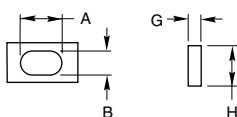

A = .064 ± .005 (1.63 ± 0.13)
B = .032 ± .004 (0.81 ± 0.10)

Solder Lug Common

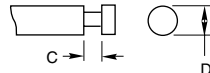

C = .050 ± .010 (1.27 ± 0.25)
D = .062 Ø ± .002 (1.57 Ø ± 0.05)

PC Mount

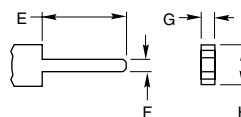

E = .125 ± .015 (3.18 ± 0.38)
F = .020 ± .003 (0.51 ± 0.08)

G = .020 ± .003 (0.51 ± 0.08)
H = .062 ± .004 (1.57 ± 0.10)

RECOMMENDED PANEL CUT

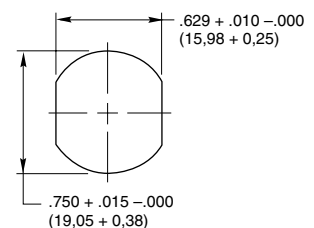

CIRCUITRY

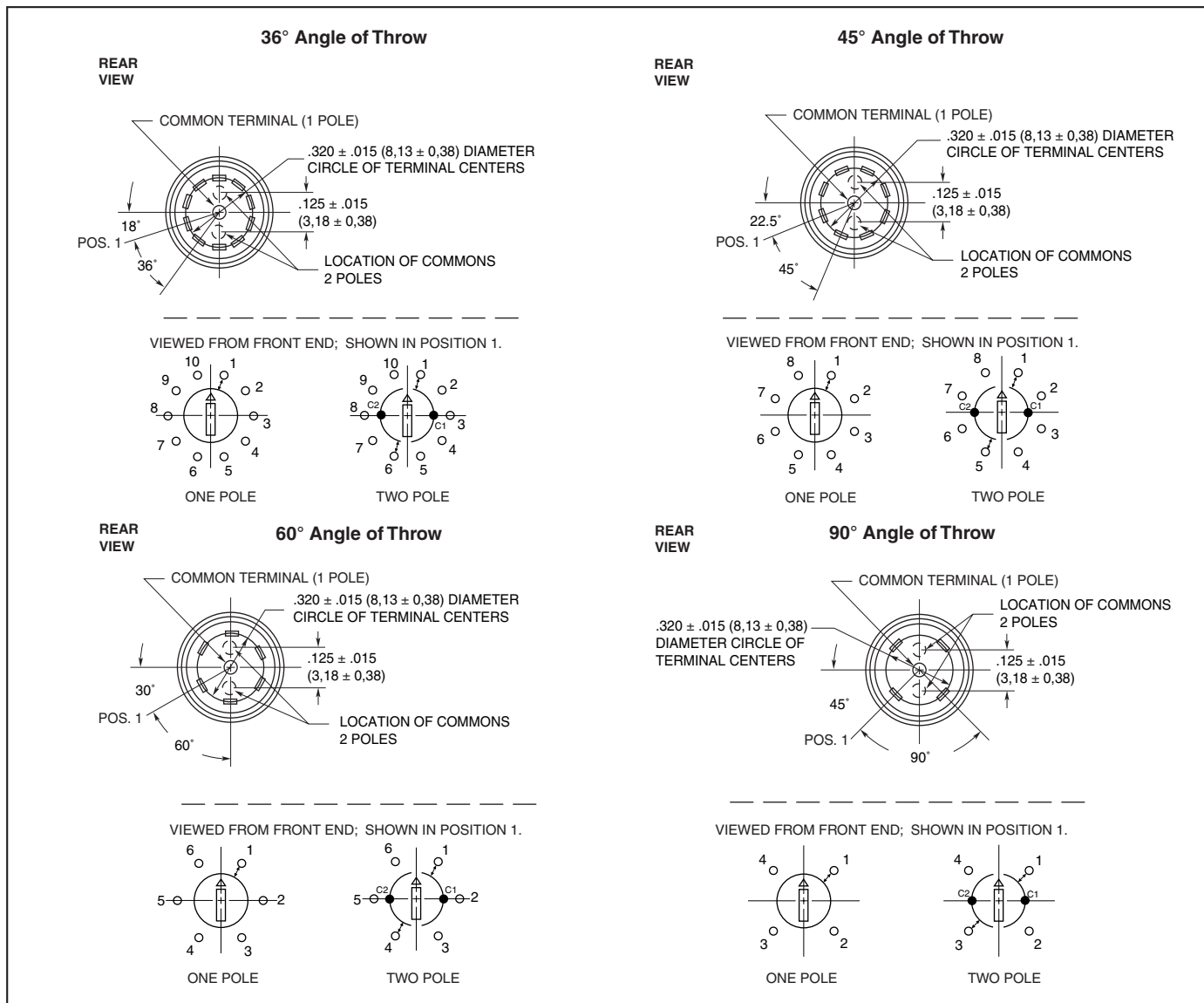

Rotary Switches

LOCK SPECIFICATIONS

General Characteristics

Mounting: By bushing, nut and lockwasher
Keying: All locks keyed alike except by special order

Orientation of Keylock Switch: Lock flats on both sides with key upright (cut side down) in position 1.

Key Removals:

- 36° Throw Switch At every position or At 0° & 180°
- 45° Throw Switch At every position or At 0°, 90°, 180°, 270°
- 60° Throw Switch At every position or At 0°, 180°
- 90° Throw Switch At every position or At 0°, 180°

Optional pulls Contact Grayhill

Materials & Finishes

- Keys:** Brass; 2 supplied
- Lock Barrel & Plug:** Zinc, clear chromate
- Lockwasher:** Steel, tin zinc plated
- Mounting Nut:** Steel, nickel-plated
- Tumbler Plates:** Brass

SWITCH SPECIFICATIONS

Electrical Characteristics

Chart is shown for non-shorting contacts and resistive load and for the life limiting criteria indicated below. The data for the curve was measured at sea level, 25°C and 68% relative humidity. Contact Grayhill for more information

if any of the following is true: life limiting criteria are more critical than those listed; more cycles of operation are required; a larger make and break current is required; the operating environment includes elevated temperatures or reduced pressures.

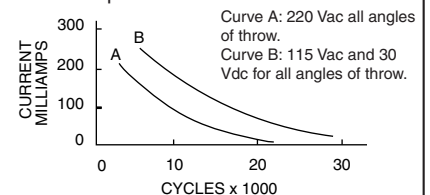

SWITCH SPECIFICATIONS *Continued*

<p>Contact Resistance: Initially: less than 10 mΩ End of life: less than 50 mΩ</p> <p>Insulation Resistance: (Between mutually insulated parts) Initially: 50,000 MΩ Minimum: 10,000 MΩ</p> <p>Breakdown Voltage: (Between mutually insulated parts) more than 600 Vac</p> <p>Life Expectancy: Per chart; cycle is 1 rotation thru all active positions plus a full return.</p> <p>Carry Current: 6A; maximum temperature rise 20°C</p>	<p>Anti-Static Voltage: Anti-static types tested to withstand 15,000 Vdc</p> <p>Mechanical Characteristics Switching Mode: Shorting (make before break) or non-shorting (break before make) as limited by the Choices chart</p> <p>Type of Contact: Wiping</p> <p>Number of Terminals: All switches are provided with the full circle of terminals regardless of the number of active positions</p> <p>Stop Strength: 1.70 Nm maximum (15.0 in-lbs)</p> <p>Switching Torque: 8 to 16 in-ozs</p>	<p>Materials and Finishes Switch Base: Thermoset plastic Switch Housing: Nylon Detent Rotor: Nylon Detent Balls: Steel, nickel-plated Detent Springs, and Contact Springs: Stainless steel Common Ring: Brass, gold plate over silver plate Terminals: Brass, gold over silver and nickel plate Rotor Contact: Precious metal, gold alloy</p>
--	--	--

CHOICES AND LIMITATIONS

Lock Style and Description*	Switch Style and Description	Angle of Throw	No. Of Decks	Poles/ Deck	Positions Per Pole**	Shorting or Non-Shrtg.
Series 58J Switches						
J4: Standard—Key pulls at Position 1 and at 90 Degree Increments	A = Standard, Solder Lugs P = Standard, PC Mount	45°	1	1 2	02 to 08 02 to 04	N or S N or S
		36°	1	1 2	02 to 10 02 to 05	N or S N or S
J8: Standard—Key Pulls at Each Position	A = Standard, Solder Lugs P = Standard, PC Mount	45°	1	1 2	02 to 08 02 to 04	N or S N or S
		90°	1	1 2	02 to 04 02	N N
		36°	1	1 2	02 to 10 02 to 05	N or S N or S
J9: Standard—Key Pulls at Position 1 and at 180 Degrees	A = Standard, Solder Lugs P = Standard, PC Mount	45°	1	1 2	02 to 08 02 to 04	N or S N or S
		60°	1	1 2	02 to 06 02 to 03	N N
		90°	1	1 2	02 to 04 02	N N
		36°	1	1 2	02 to 10 02 to 05	N or S N or S

*Standard Keylock has anti-static protection. All keylock versions available without anti-static protection, with a reduced overall body length. Contact Grayhill for more information.

**For single pole switches with maximum positions, specify continuous rotation or fixed stop when ordering.

ORDERING INFORMATION

Series
Lock Style: per Choices Chart J4, J8, J9
Switch Style: per Choices Chart A or P
Angle of Throw: 36, 45, 60 or 90 (per Choices chart)
Number of Decks: 01
Poles per Deck: = 1 or 2 (per Choices chart)
Positions per Pole: 02 thru 10 (per Choices chart)
Type of Contacts: (per Choices chart)
 N = Non-shorting
 S = Shorting
Stop Arrangement Suffix:
 (needed only for 1-pole switches with maximum positions)
 F = Fixed stop between last and first positions
 *Leave blank for continuous rotation

58J8A36-01-1-10N-F

Available from your local Grayhill Distributor. For prices and discounts, contact a local Sales Office, an authorized local Distributor or Grayhill.

Данный компонент на территории Российской Федерации

Вы можете приобрести в компании MosChip.

Для оперативного оформления запроса Вам необходимо перейти по данной ссылке:

<http://moschip.ru/get-element>

Вы можете разместить у нас заказ для любого Вашего проекта, будь то серийное производство или разработка единичного прибора.

В нашем ассортименте представлены ведущие мировые производители активных и пассивных электронных компонентов.

Нашей специализацией является поставка электронной компонентной базы двойного назначения, продукции таких производителей как XILINX, Intel (ex.ALTERA), Vicor, Microchip, Texas Instruments, Analog Devices, Mini-Circuits, Amphenol, Glenair.

Сотрудничество с глобальными дистрибьюторами электронных компонентов, предоставляет возможность заказывать и получать с международных складов практически любой перечень компонентов в оптимальные для Вас сроки.

На всех этапах разработки и производства наши партнеры могут получить квалифицированную поддержку опытных инженеров.

Система менеджмента качества компании отвечает требованиям в соответствии с ГОСТ Р ИСО 9001, ГОСТ РВ 0015-002 и ЭС РД 009

Офис по работе с юридическими лицами:

105318, г.Москва, ул.Щербаковская д.3, офис 1107, 1118, ДЦ «Щербаковский»

Телефон: +7 495 668-12-70 (многоканальный)

Факс: +7 495 668-12-70 (доб.304)

E-mail: info@moschip.ru

Skype отдела продаж:

moschip.ru

moschip.ru_4

moschip.ru_6

moschip.ru_9