

Trench gate field-stop IGBT, H series 600 V, 14 A high speed

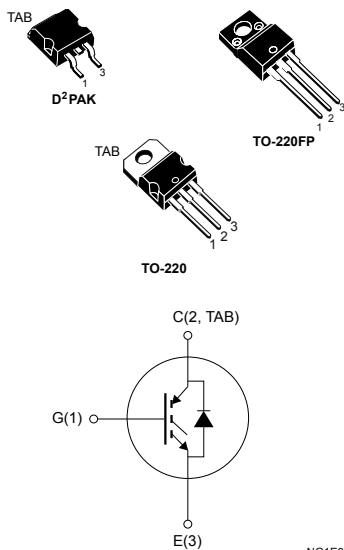

Features

- High speed switching
- Tight parameters distribution
- Safe paralleling
- Low thermal resistance
- Short-circuit rated
- Ultrafast soft recovery antiparallel diode

Applications

- Motor control
- UPS, PFC

Description

These devices are IGBTs developed using an advanced proprietary trench gate field-stop structure. These devices are part of the H series of IGBTs, which represents an optimum compromise between conduction and switching losses to maximize the efficiency of high switching frequency converters. Furthermore, a slightly positive $V_{CE(sat)}$ temperature coefficient and very tight parameter distribution result in safer paralleling operation.

Product status link

[STGB15H60DF](#)
[STGF15H60DF](#)
[STGP15H60DF](#)

1 Electrical ratings

Table 1. Absolute maximum ratings

Symbol	Parameter	Value		Unit
		D ² PAK, TO-220	TO-220FP	
V _{CES}	Collector-emitter voltage (V _{GE} = 0 V)	600		V
I _C	Continuous collector current at T _C = 25 °C	30	30 ⁽¹⁾	A
	Continuous collector current at T _C = 100 °C	15	15 ⁽¹⁾	
I _{CP} ⁽²⁾	Pulsed collector current	60	60	A
V _{GE}	Gate-emitter voltage	±20		V
I _F	Continuous forward current T _C = 25 °C	30	30 ⁽¹⁾	A
	Continuous forward current at T _C = 100 °C	15	15 ⁽¹⁾	
I _{FP} ⁽²⁾	Pulsed forward current	60	60	A
V _{ISO}	Insulation withstand voltage (RMS) from all three leads to external heat sink (t = 1 s; T _C = 25 °C)		2500	V
P _{TOT}	Total power dissipation at T _C = 25 °C	115	30	W
T _{STG}	Storage temperature range	-55 to 150		°C
T _J	Operating junction temperature range	-55 to 175		

1. Limited by maximum junction temperature.
2. Pulse width limited by maximum junction temperature.

Table 2. Thermal data

Symbol	Parameter	Value		Unit
		D ² PAK, TO-220	TO-220FP	
R _{thJC}	Thermal resistance junction-case IGBT	1.3	5	°C/W
R _{thJC}	Thermal resistance junction-case diode	2.78	6.25	°C/W
R _{thJA}	Thermal resistance junction-ambient	62.5	62.5	°C/W

2 Electrical characteristics

$T_C = 25\text{ °C}$ unless otherwise specified.

Table 3. Static

Symbol	Parameter	Test conditions	Min.	Typ.	Max.	Unit
$V_{(BR)CES}$	Collector-emitter breakdown voltage	$V_{GE} = 0\text{ V}$, $I_C = 2\text{ mA}$	600			V
$V_{CE(sat)}$	Collector-emitter saturation voltage	$V_{GE} = 15\text{ V}$, $I_C = 15\text{ A}$		1.6	2.0	V
		$V_{GE} = 15\text{ V}$, $I_C = 15\text{ A}$ $T_J = 125\text{ °C}$		1.7		
		$V_{GE} = 15\text{ V}$, $I_C = 15\text{ A}$ $T_J = 175\text{ °C}$		1.8		
$V_{GE(th)}$	Gate threshold voltage	$V_{CE} = V_{GE}$, $I_C = 1\text{ mA}$	5.0	6.0	7.0	V
I_{CES}	Collector cut-off current	$V_{CE} = 600\text{ V}$ $V_{GE} = 0\text{ V}$			25	μA
I_{GES}	Gate-emitter leakage current	$V_{GE} = \pm 20\text{ V}$ $V_{CE} = 0\text{ V}$			± 250	nA

Table 4. Dynamic

Symbol	Parameter	Test conditions	Min.	Typ.	Max.	Unit
C_{ies}	Input capacitance	$V_{CE} = 25\text{ V}$, $f = 1\text{ MHz}$, $V_{GE} = 0\text{ V}$	-	1952	-	μF
C_{oes}	Output capacitance			78		
C_{res}	Reverse transfer capacitance			45		
Q_g	Total gate charge	$V_{CC} = 480\text{ V}$, $I_C = 15\text{ A}$, $V_{GE} = 0\text{ to }15\text{ V}$ (see Figure 33. Gate charge test circuit)	-	81	-	nC
Q_{ge}	Gate-emitter charge			8		
Q_{gc}	Gate-collector charge			42		

Table 5. Switching characteristics (inductive load)

Symbol	Parameter	Test conditions	Min.	Typ.	Max.	Unit
$t_{d(on)}$	Turn-on delay time	$V_{CE} = 400\text{ V}$, $I_C = 15\text{ A}$, $R_G = 10\ \Omega$, $V_{GE} = 15\text{ V}$ (see Figure 32. Test circuit for inductive load switching and Figure 34. Switching waveform)		24.5	-	ns
t_r	Current rise time			8.2		
$(di/dt)_{on}$	Turn-on current slope			1470		
$t_{d(on)}$	Turn-on delay time	$V_{CE} = 400\text{ V}$, $I_C = 15\text{ A}$, $R_G = 10\ \Omega$, $V_{GE} = 15\text{ V}$ $T_J = 175\text{ °C}$ (see Figure 32. Test circuit for inductive load switching and Figure 34. Switching waveform)		25	-	ns
t_r	Current rise time			9		
$(di/dt)_{on}$	Turn-on current slope			1370		

Symbol	Parameter	Test conditions	Min.	Typ.	Max.	Unit
$t_{r(Voff)}$	Off voltage rise time	$V_{CE} = 400\text{ V}$, $I_C = 15\text{ A}$, $R_G = 10\ \Omega$, $V_{GE} = 15\text{ V}$ (see Figure 32. Test circuit for inductive load switching and Figure 34. Switching waveform)		18		ns
$t_{d(off)}$	Turn-off delay time			118		
t_f	Current fall time			69		
$t_{r(Voff)}$	Off voltage rise time	$V_{CE} = 400\text{ V}$, $I_C = 15\text{ A}$, $R_G = 10\ \Omega$, $V_{GE} = 15\text{ V}$ $T_J = 175\text{ }^\circ\text{C}$ (see Figure 32. Test circuit for inductive load switching and Figure 34. Switching waveform)		27	-	ns
$t_{d(off)}$	Turn-off delay time			124		
t_f	Current fall time			101		
t_{sc}	Short-circuit withstand time	$V_{CC} \leq 360\text{ V}$, $V_{GE} = 15\text{ V}$, $R_G = 10\ \Omega$	3	5	-	μs

Table 6. Switching energy (inductive load)

Symbol	Parameter	Test conditions	Min.	Typ.	Max.	Unit
$E_{on}^{(1)}$	Turn-on switching energy	$V_{CE} = 400\text{ V}$, $I_C = 15\text{ A}$, $R_G = 10\ \Omega$, $V_{GE} = 15\text{ V}$ (see Figure 32. Test circuit for inductive load switching)		136		μJ
$E_{off}^{(2)}$	Turn-off switching energy			207		
E_{is}	Total switching energy			343		
$E_{on}^{(1)}$	Turn-on switching energy	$V_{CE} = 400\text{ V}$, $I_C = 15\text{ A}$, $R_G = 10\ \Omega$, $V_{GE} = 15\text{ V}$ $T_J = 175\text{ }^\circ\text{C}$ (see Figure 32. Test circuit for inductive load switching)	-	224	-	μJ
$E_{off}^{(2)}$	Turn-off switching energy			329		
E_{is}	Total switching energy			553		

1. Including the reverse recovery of the diode.
2. Including the tail of the collector current.

Table 7. Collector-emitter diode

Symbol	Parameter	Test conditions	Min.	Typ.	Max.	Unit
V_F	Forward on-voltage	$I_F = 15\text{ A}$	-	1.8	2.2	V
		$I_F = 15\text{ A}$, $T_J = 175\text{ }^\circ\text{C}$		1.3		
t_{rr}	Reverse recovery time	$V_r = 60\text{ V}$; $I_F = 15\text{ A}$; $di_F/dt = 100\text{ A}/\mu\text{s}$ (see Figure 35. Diode reverse recovery waveform)		103		ns
Q_{rr}	Reverse recovery charge			128		nC
I_{rrm}	Reverse recovery current			2.5		A
t_{rr}	Reverse recovery time	$V_r = 60\text{ V}$; $I_F = 15\text{ A}$; $di_F/dt = 100\text{ A}/\mu\text{s}$ $T_J = 175\text{ }^\circ\text{C}$ (see Figure 35. Diode reverse recovery waveform)	-	182		ns
Q_{rr}	Reverse recovery charge			437		nC
I_{rrm}	Reverse recovery current			4.8		A

2.1 Electrical characteristics (curves)

Figure 1. Power dissipation vs case temperature for D²PAK and TO-220

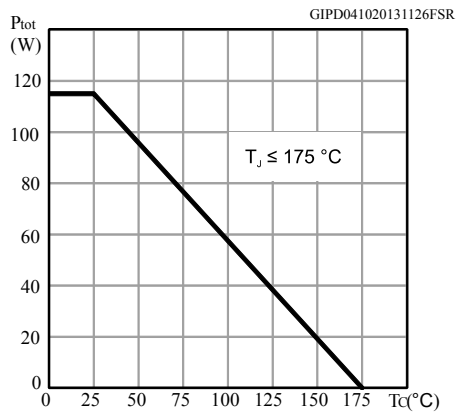

Figure 2. Collector current vs case temperature for D²PAK and TO-220

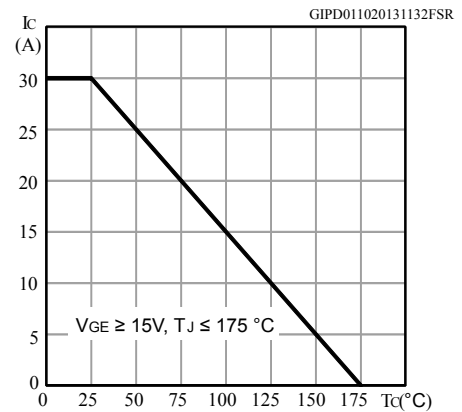

Figure 3. Power dissipation vs case temperature for TO-220FP

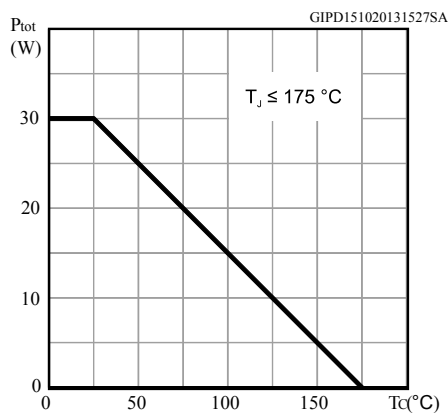

Figure 4. Collector current vs case temperature for TO-220FP

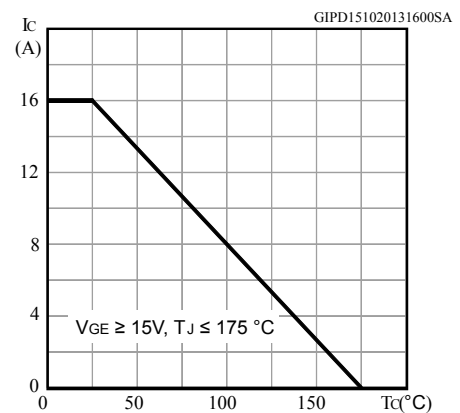

Figure 5. Output characteristics (T_J = 25°C)

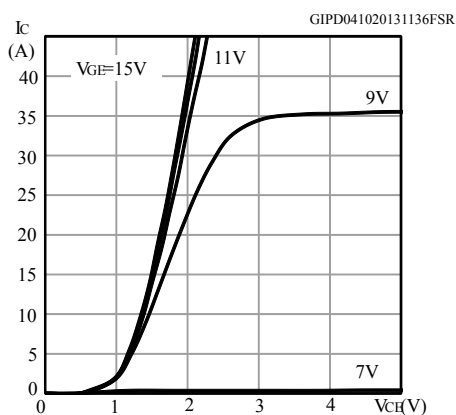

Figure 6. Output characteristics (T_J = 175°C)

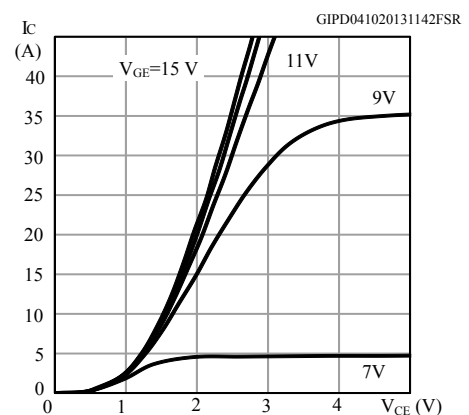

Figure 7. $V_{CE(sat)}$ vs junction temperature

Figure 8. $V_{CE(sat)}$ vs collector current

Figure 9. Collector current vs switching frequency for D²PAK and TO-220

Figure 10. Collector current vs switching frequency for TO-220FP

Figure 11. Forward bias safe operating area for D²PAK and TO-220

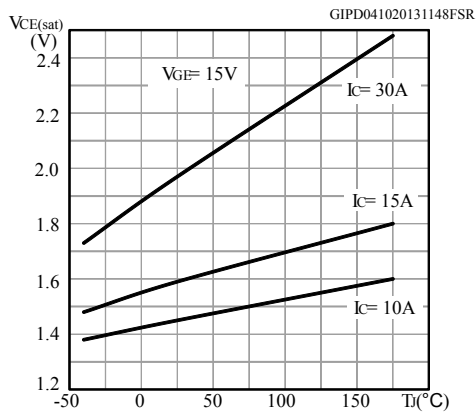
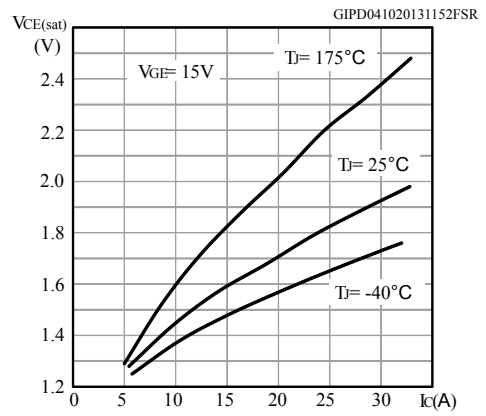
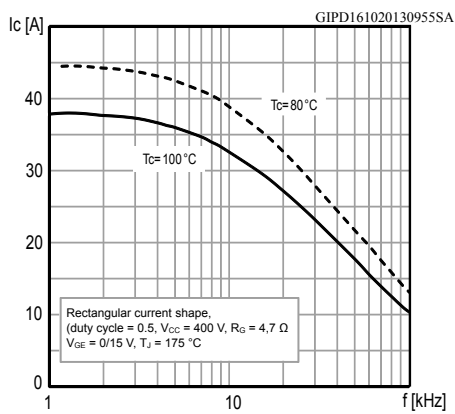
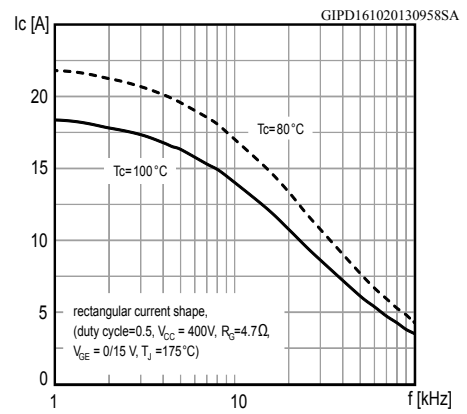
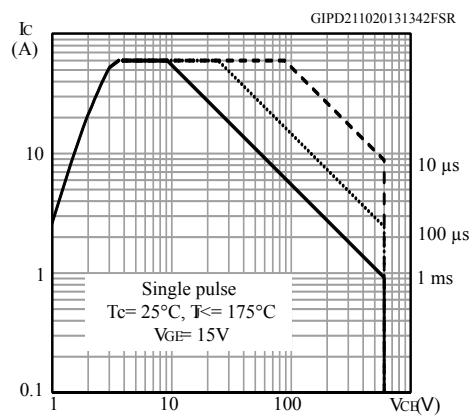
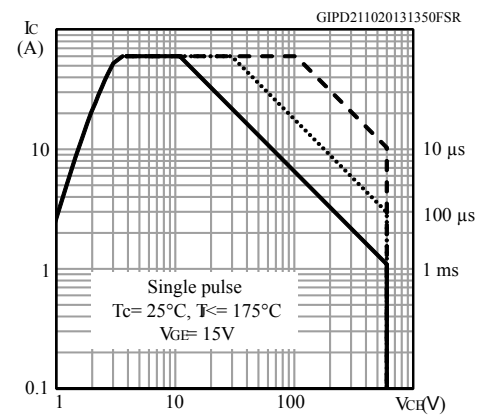
Figure 12. Forward bias safe operating area for TO-220FP

Figure 13. Transfer characteristics

Figure 14. Diode V_F vs forward current

Figure 15. Normalized $V_{GE(th)}$ vs junction temperature

Figure 16. Normalized $V_{(BR)CES}$ vs junction temperature

Figure 17. Capacitance variation

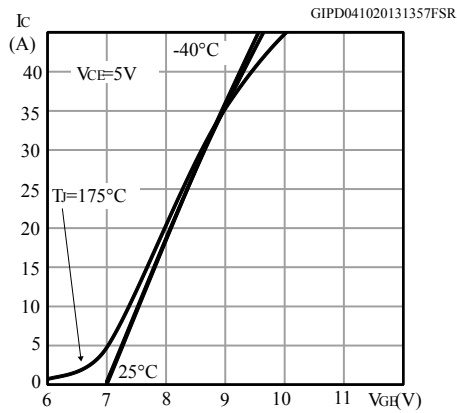
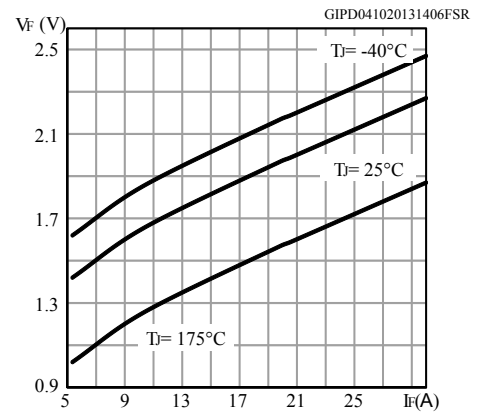
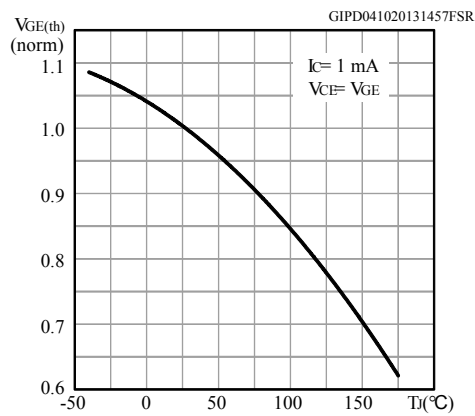
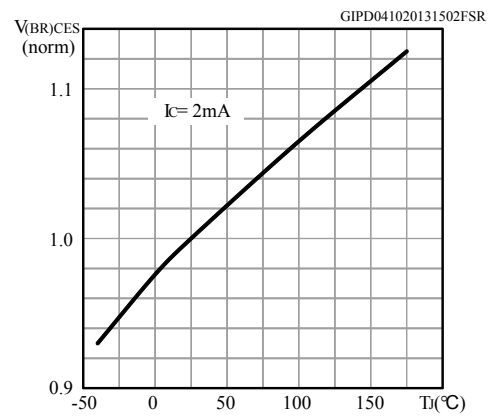
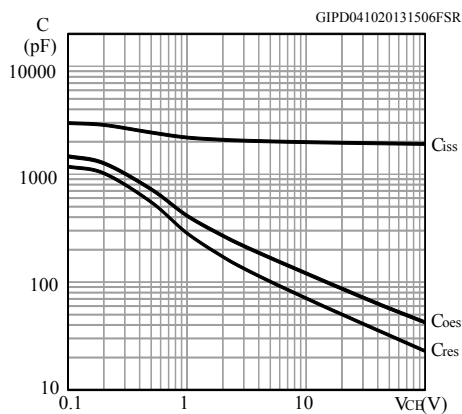
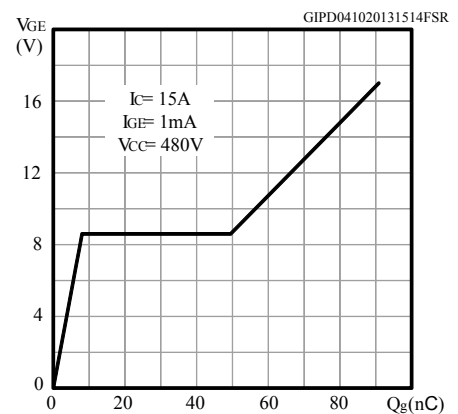
Figure 18. Gate charge vs gate-emitter voltage

Figure 19. Switching energy vs collector current

Figure 20. Switching energy vs gate resistance

Figure 21. Switching energy vs temperature

Figure 22. Switching energy vs collector-emitter voltage

Figure 23. Short-circuit time and current vs VGE

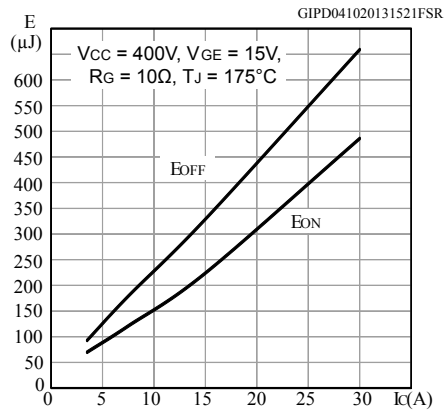
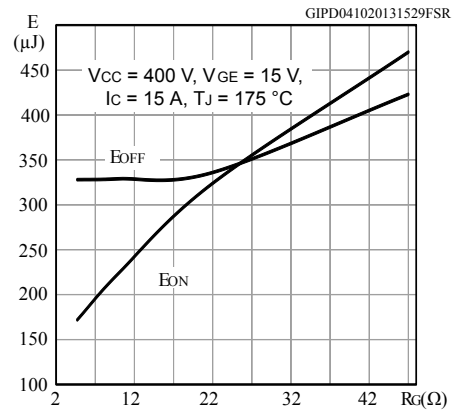
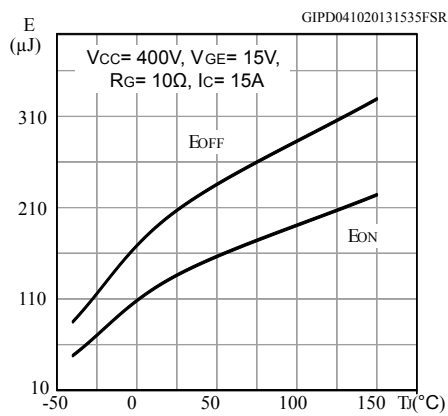
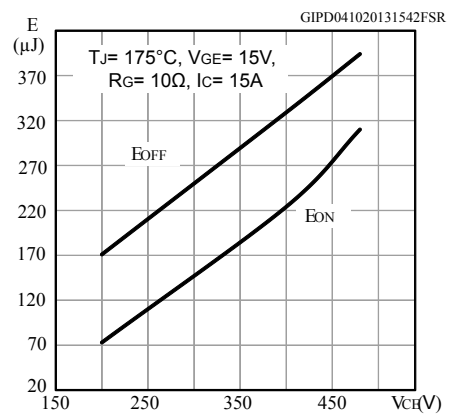
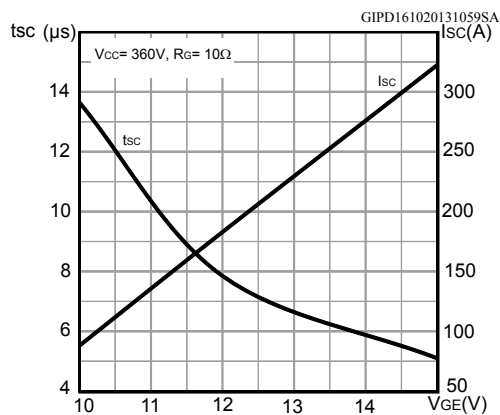
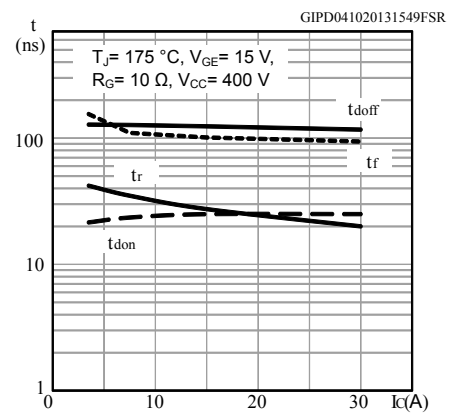
Figure 24. Switching times vs collector current

Figure 25. Switching times vs gate resistance

Figure 26. Reverse recovery current vs diode current slope

Figure 27. Reverse recovery time vs diode current slope

Figure 28. Reverse recovery charge vs diode current slope

Figure 29. Reverse recovery energy vs diode current slope

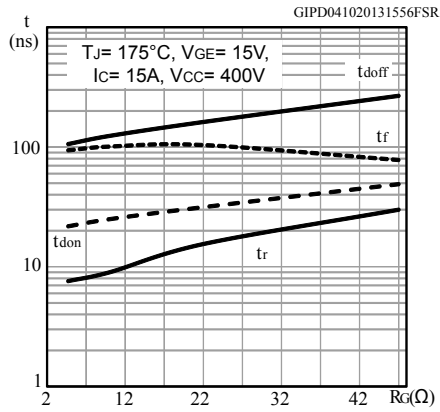
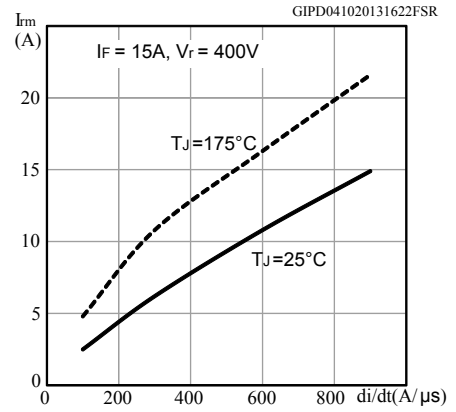
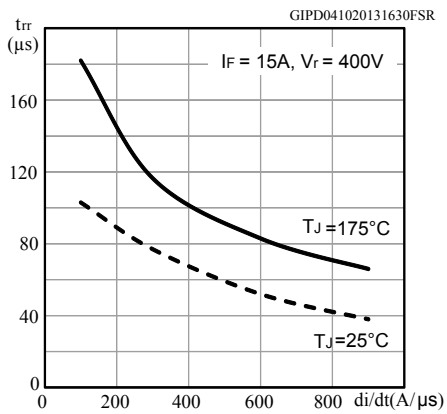
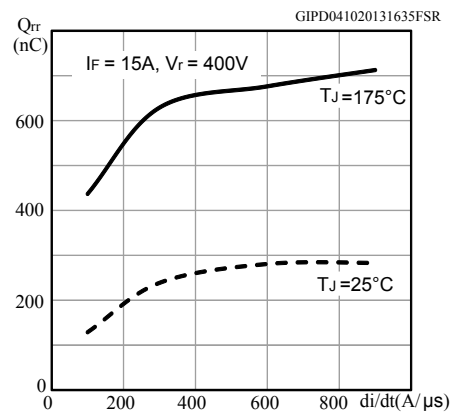
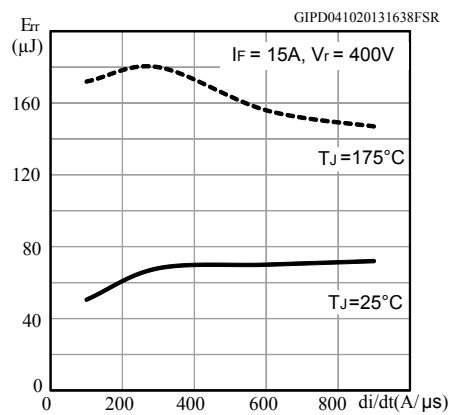
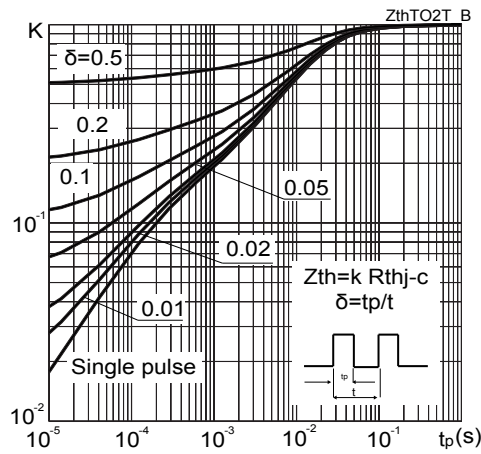
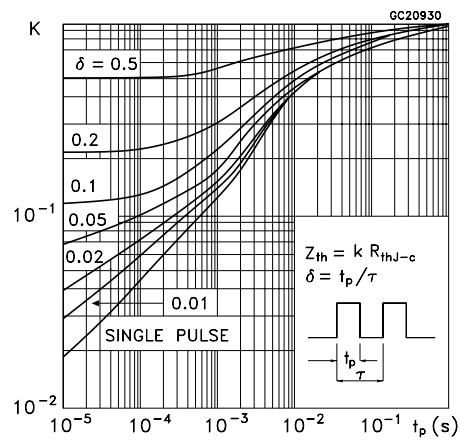
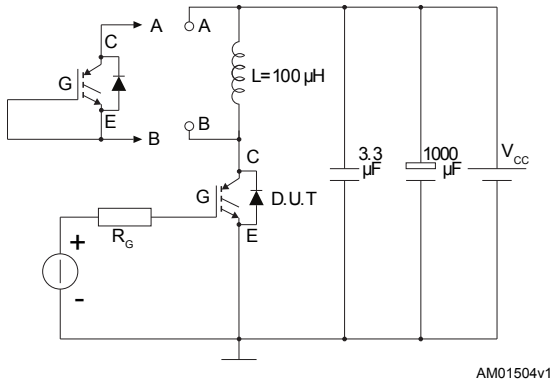
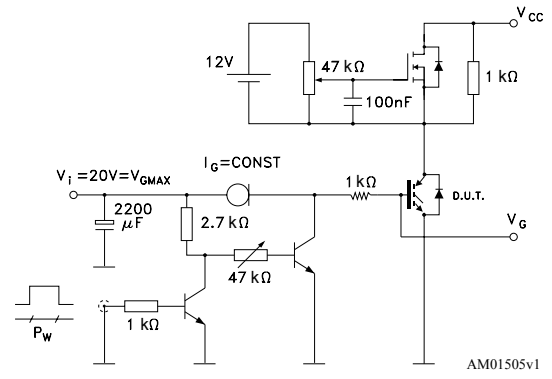
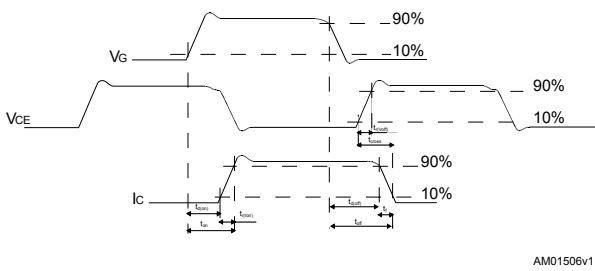
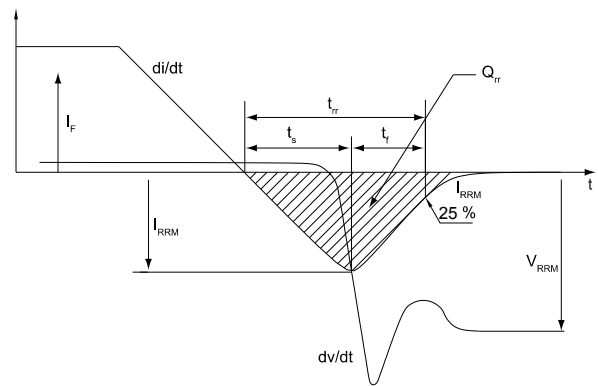
Figure 30. Thermal impedance for IGBT

Figure 31. Thermal impedance for diode

3 Test circuits

Figure 32. Test circuit for inductive load switching

Figure 33. Gate charge test circuit

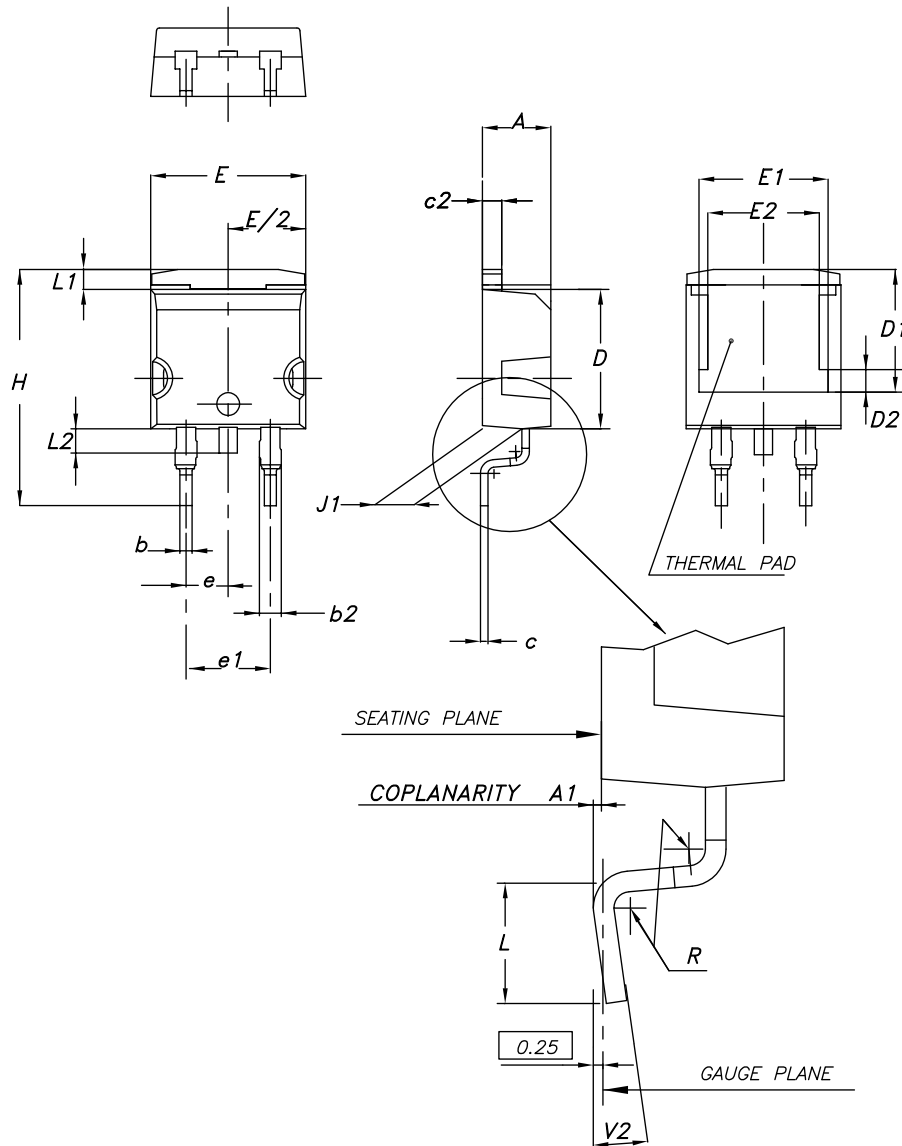
Figure 34. Switching waveform

Figure 35. Diode reverse recovery waveform

4 Package information

In order to meet environmental requirements, ST offers these devices in different grades of **ECOPACK** packages, depending on their level of environmental compliance. ECOPACK specifications, grade definitions and product status are available at: www.st.com. ECOPACK is an ST trademark.

4.1 D²PAK (TO-263) type A2 package information
Figure 36. D²PAK (TO-263) type A2 package outline

0079457_A2_25

Table 8. D²PAK (TO-263) type A2 package mechanical data

Dim.	mm		
	Min.	Typ.	Max.
A	4.40		4.60
A1	0.03		0.23
b	0.70		0.93
b2	1.14		1.70
c	0.45		0.60
c2	1.23		1.36
D	8.95		9.35
D1	7.50	7.75	8.00
D2	1.10	1.30	1.50
E	10.00		10.40
E1	8.70	8.90	9.10
E2	7.30	7.50	7.70
e		2.54	
e1	4.88		5.28
H	15.00		15.85
J1	2.49		2.69
L	2.29		2.79
L1	1.27		1.40
L2	1.30		1.75
R		0.40	
V2	0°		8°

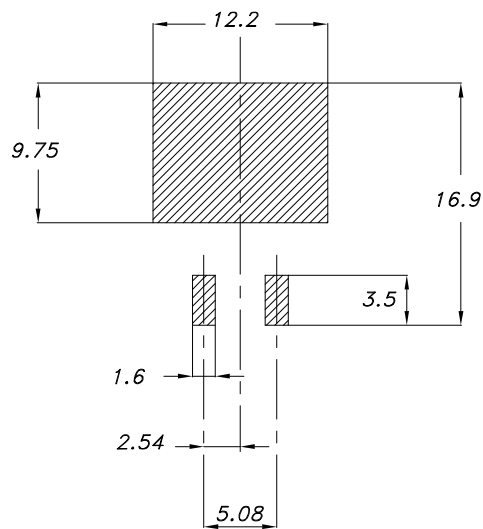
Figure 37. D²PAK (TO-263) recommended footprint (dimensions are in mm)

Footprint

4.2 D²PAK packing information

Figure 38. D²PAK tape outline

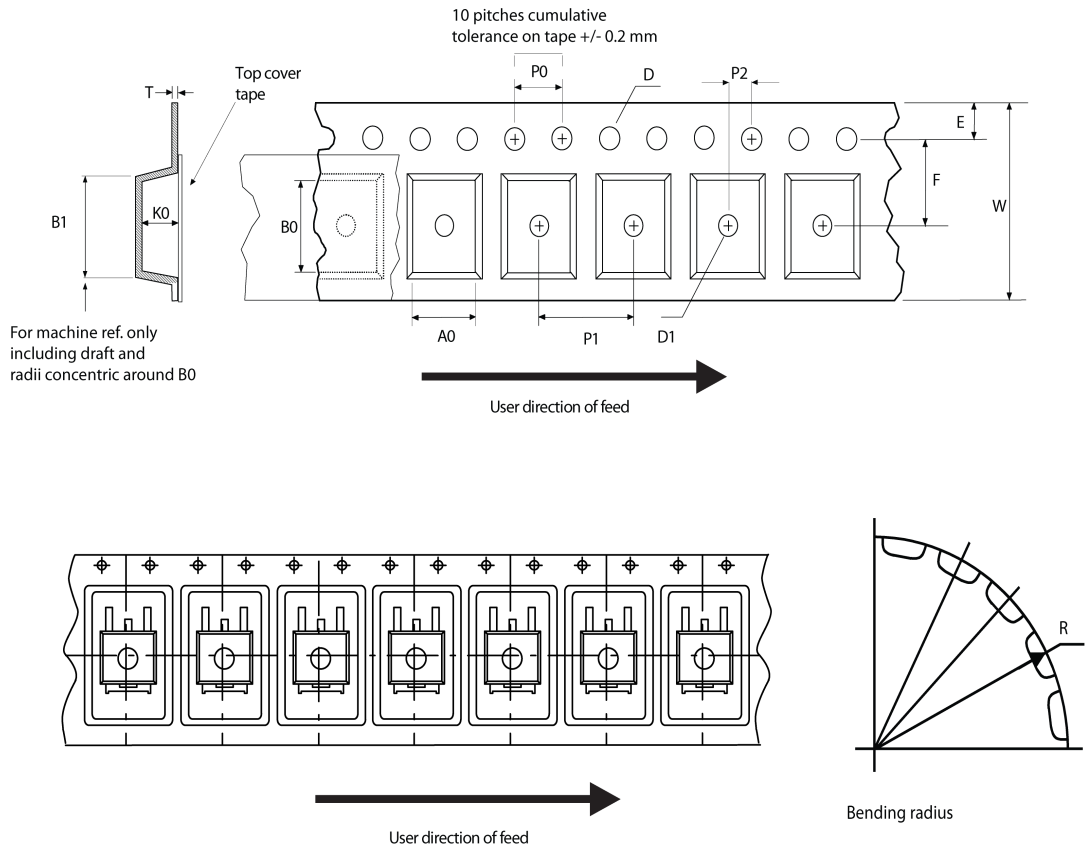

AM08852v1

Figure 39. D²PAK reel outline



AM06038v1

Table 9. D²PAK tape and reel mechanical data

Tape			Reel		
Dim.	mm		Dim.	mm	
	Min.	Max.		Min.	Max.
A0	10.5	10.7	A		330
B0	15.7	15.9	B	1.5	
D	1.5	1.6	C	12.8	13.2
D1	1.59	1.61	D	20.2	
E	1.65	1.85	G	24.4	26.4
F	11.4	11.6	N	100	
K0	4.8	5.0	T		30.4
P0	3.9	4.1			
P1	11.9	12.1	Base quantity		1000
P2	1.9	2.1	Bulk quantity		1000
R	50				
T	0.25	0.35			
W	23.7	24.3			

4.3 TO-220FP package information

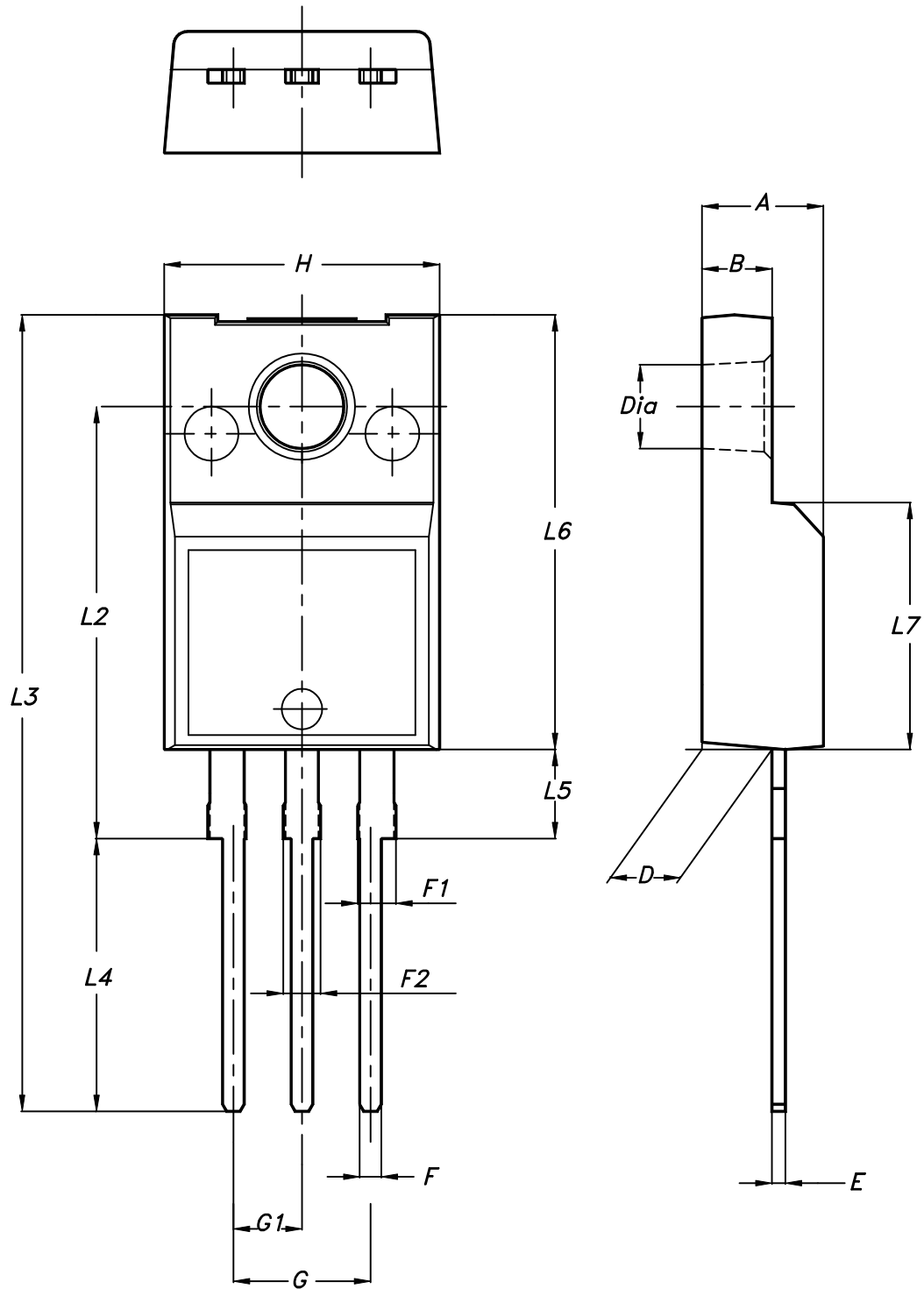
Figure 40. TO-220FP package outline



7012510_Rev_12_B

Table 10. TO-220FP package mechanical data

Dim.	mm		
	Min.	Typ.	Max.
A	4.4		4.6
B	2.5		2.7
D	2.5		2.75
E	0.45		0.7
F	0.75		1
F1	1.15		1.70
F2	1.15		1.70
G	4.95		5.2
G1	2.4		2.7
H	10		10.4
L2		16	
L3	28.6		30.6
L4	9.8		10.6
L5	2.9		3.6
L6	15.9		16.4
L7	9		9.3
Dia	3		3.2

4.4 TO-220 type A package information

Figure 41. TO-220 type A package outline

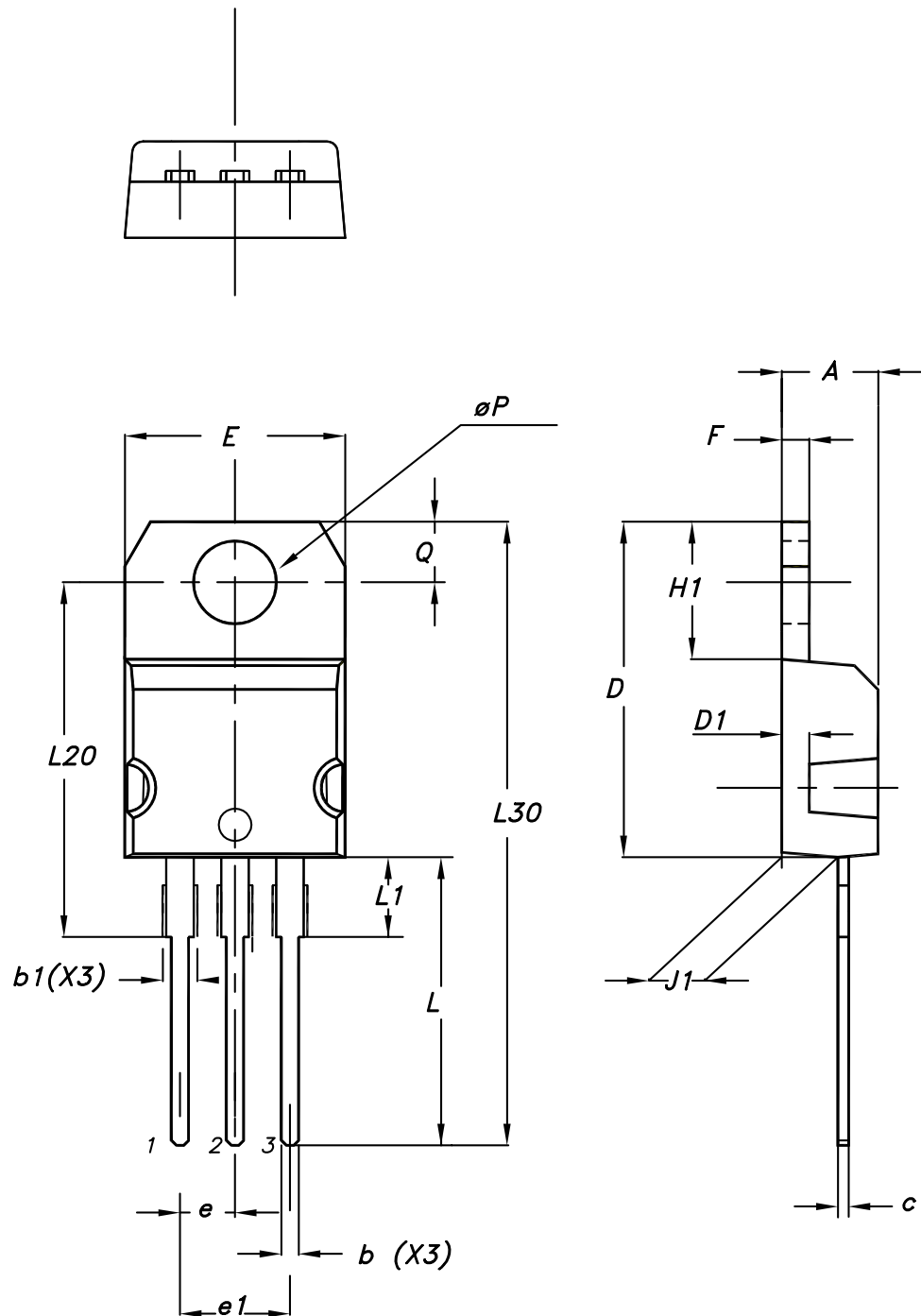

0015988_typeA_Rev_22

Table 11. TO-220 type A package mechanical data

Dim.	mm		
	Min.	Typ.	Max.
A	4.40		4.60
b	0.61		0.88
b1	1.14		1.55
c	0.48		0.70
D	15.25		15.75
D1		1.27	
E	10.00		10.40
e	2.40		2.70
e1	4.95		5.15
F	1.23		1.32
H1	6.20		6.60
J1	2.40		2.72
L	13.00		14.00
L1	3.50		3.93
L20		16.40	
L30		28.90	
øP	3.75		3.85
Q	2.65		2.95

5 Ordering information

Table 12. Order codes

Order code	Marking	Package	Packing
STGB15H60DF	GB15H60DF	D ² PAK	Tape and reel
STGF15H60DF	GF15H60DF	TO-220FP	Tube
STGP15H60DF	GP15H60DF	TO-220	

Revision history

Table 13. Document revision history

Date	Version	Changes
12-Aug-2013	1	Initial release.
17-Oct-2013	2	Document status promoted from preliminary to production data. Added <i>Section 2.1: Electrical characteristics (curves)</i> . Minor text changes.
09-Apr-2019	3	Updated applications and description on cover page. Updated Section 4 Package information . Minor text changes.

Contents

1	Electrical ratings	2
2	Electrical characteristics	3
2.1	Electrical characteristics (curves)	5
3	Test circuits	11
4	Package information	12
4.1	D ² PAK (TO-263) type A2 package information	12
4.2	D ² PAK packing information	14
4.3	TO-220FP package information	16
4.4	TO-220 type A package information	18
5	Ordering information	21
	Revision history	22

IMPORTANT NOTICE – PLEASE READ CAREFULLY

STMicroelectronics NV and its subsidiaries (“ST”) reserve the right to make changes, corrections, enhancements, modifications, and improvements to ST products and/or to this document at any time without notice. Purchasers should obtain the latest relevant information on ST products before placing orders. ST products are sold pursuant to ST’s terms and conditions of sale in place at the time of order acknowledgement.

Purchasers are solely responsible for the choice, selection, and use of ST products and ST assumes no liability for application assistance or the design of Purchasers’ products.

No license, express or implied, to any intellectual property right is granted by ST herein.

Resale of ST products with provisions different from the information set forth herein shall void any warranty granted by ST for such product.

ST and the ST logo are trademarks of ST. For additional information about ST trademarks, please refer to www.st.com/trademarks. All other product or service names are the property of their respective owners.

Information in this document supersedes and replaces information previously supplied in any prior versions of this document.

© 2019 STMicroelectronics – All rights reserved

Данный компонент на территории Российской Федерации

Вы можете приобрести в компании MosChip.

Для оперативного оформления запроса Вам необходимо перейти по данной ссылке:

<http://moschip.ru/get-element>

Вы можете разместить у нас заказ для любого Вашего проекта, будь то серийное производство или разработка единичного прибора.

В нашем ассортименте представлены ведущие мировые производители активных и пассивных электронных компонентов.

Нашей специализацией является поставка электронной компонентной базы двойного назначения, продукции таких производителей как XILINX, Intel (ex.ALTERA), Vicor, Microchip, Texas Instruments, Analog Devices, Mini-Circuits, Amphenol, Glenair.

Сотрудничество с глобальными дистрибьюторами электронных компонентов, предоставляет возможность заказывать и получать с международных складов практически любой перечень компонентов в оптимальные для Вас сроки.

На всех этапах разработки и производства наши партнеры могут получить квалифицированную поддержку опытных инженеров.

Система менеджмента качества компании отвечает требованиям в соответствии с ГОСТ Р ИСО 9001, ГОСТ РВ 0015-002 и ЭС РД 009

Офис по работе с юридическими лицами:

105318, г.Москва, ул.Щербаковская д.3, офис 1107, 1118, ДЦ «Щербаковский»

Телефон: +7 495 668-12-70 (многоканальный)

Факс: +7 495 668-12-70 (доб.304)

E-mail: info@moschip.ru

Skype отдела продаж:

moschip.ru

moschip.ru_4

moschip.ru_6

moschip.ru_9