

MAXIM

MAX9700B Evaluation Kit

General Description

The MAX9700B evaluation kit (EV kit) is a fully assembled and tested circuit board that uses the MAX9700B filterless class D amplifier to drive a mono bridge-tied-load (BTL) speaker in portable audio applications. Designed to operate from a 2.5V to 5.5V DC power supply, the EV kit is capable of delivering 1.2W into an 8Ω load.

The EV kit accepts differential or single-ended input signals. The EV kit provides an option to select between different switching frequency modes of operation. The MAX9700B EV kit also evaluates the MAX9700A/MAX9700C/MAX9700D and the MAX9712.

Ordering Information

PART	TEMP RANGE	IC PACKAGE
MAX9700BEVKIT	0°C to +70°C	10 TDFN-EP*

*EP = Exposed paddle.

Features

- ◆ Filterless Operation Passes FCC Radiated Emissions
- ◆ Evaluates the MAX9700A/B/C/D or MAX9712 (with IC Replacement)
- ◆ 2.5V to 5.5V Single-Supply Operation
- ◆ Up to 94% Efficiency
- ◆ Drives 1.2W into 8Ω Speaker at 1% THD+N
- ◆ Differential or Single-Ended Inputs
- ◆ Selectable Switching Frequency
- ◆ 0.1μA Shutdown Current
- ◆ Small 10-Pin TDFN Package
- ◆ Also Available in 10-Pin μMAX and 12-Bump UCSP™ Packages
- ◆ Fully Assembled and Tested

UCSP is a trademark of Maxim Integrated Products, Inc.

Component List

DESIGNATION	QTY	DESCRIPTION
A1	0	Not installed, MAX9700BEUB (10-pin μMAX)
A2	0	Not installed, MAX9700BEBC-T (12-bump UCSP)
C1, C2	2	0.1μF ±10%, 25V X7R ceramic capacitors (0603) TDK C1608X7R1E104K
C3	1	10μF ±20%, 6.3V X5R ceramic capacitor (0805) TDK C2012X5R0J106M
C4	0	Not installed, capacitor (0805)
C5, C6	2	1μF ±10%, 10V X5R ceramic capacitors (0603) TDK C1608X5R1A105K
C7, C8, C9, C11–C14	0	Not installed, capacitors (0603)
C10	1	100pF ±5%, 50V C0G ceramic capacitor (0603) TDK C1608C0G1H101J

DESIGNATION	QTY	DESCRIPTION
JU1	1	3-pin header
JU2	1	5-pin header
JU3	1	2-pin header
L1, L2	0	Not installed, inductors recommended TOKO D53LC series
L3, L4, L5	3	Ferrite beads 100Ω at 100MHz, 50mΩ DCR, 3A (0603) TDK MPZ1608S101A
R1	1	49.9Ω ±1% resistor (0603)
R2, R3	0	Not installed, resistors (0603)
T1	0	Not installed, common-mode choke 50VDC, 1ADC 800Ω at 100MHz recommended TDK ACM4532-801-2P-X
U1	1	MAX9700BETB (10-pin TDFN, 3mm x 3mm x 0.8mm))
None	3	Shunts (JU1, JU2, JU3)
None	1	MAX9700B PC board

Evaluates: MAX9700A/B/C/D/MAX9712

MAX9700B Evaluation Kit

Component Suppliers

SUPPLIER	PHONE	FAX	WEBSITE
TDK	847-803-6100	847-390-4405	www.component.tdk.com
TOKO	847-297-0070	847-699-1194	www.tokoam.com

Note: Please indicate that you are using the MAX9700B when contacting these component suppliers.

Quick Start

The MAX9700B EV kit is fully assembled and tested. Follow the steps listed below to verify board operation.

Do not turn on the power supply until all connections are completed.

Recommended Equipment:

- 2.5V to 5.5V, 1A power supply
- Audio source (i.e. CD player, cassette player)
- 8Ω speaker

Procedures:

- 1) Install a shunt across pins 1 and 2 of jumper JU1 (EV kit ON).
- 2) Install a shunt across pins 1 and 2 of jumper JU2 (internal oscillator set to spread-spectrum mode).
- 3) Verify that no shunt is across jumper JU3 (differential input mode).
- 4) Connect the 8Ω speaker across the OUT+ and OUT- test points.
- 5) Connect the positive terminal of the power supply to the VDD pad and the power-supply ground terminal to the GND pad.
- 6) Connect the audio source across the INPUT+ and INPUT- pads.
- 7) Turn on the power supply.
- 8) Turn on the audio source.

Detailed Description

The MAX9700B EV kit features the MAX9700B filterless class D amplifier IC, designed to drive a BTL mono speaker in portable audio applications. The EV kit operates from a DC power supply that can provide 2.5V to 5.5V and 1A of current. The EV kit accepts a differential or single-ended audio input. The audio input source is amplified to drive 1.2W into an 8Ω speaker.

The EV kit provides three sets of differential outputs. The device outputs (OUT+/-) can be connected directly to a speaker load without any filtering. However, a filter can be added to ease evaluation. The filtered outputs (FOUTPUT+/-) require installation of filtering components L1, L2, C7, C8, C9, C13, C14, R2, and R3. When an LCR filter is required, remove C11, C12, and T1,

short T1-1 to T1-4, and short T1-2 to T1-3. See Table 1 for the suggested filtering component values for an 8Ω load and a 30kHz cutoff frequency.

Table 1. Suggested Filtering Components for an 8Ω Load and 30kHz Cut-Off

COMPONENT	VALUE
L1, L2	15μH
C7, C8	0.033μF
C9	0.15μF
C13, C14	0.068μF
R2, R3	22Ω

The MAX9700B is designed to pass FCC Class-B RF emissions without additional filtering when using 10cm of cable to connect the speaker. In applications where more margin and/or cable length are required, output capacitors C11, C12 and common-mode choke T1 can be added to reduce radiated emission. Connect the speaker to output +/- test points. Table 2 lists the cable length verses the required output components.

Table 2. Cable Length vs. Suggested Output Components

CABLE LENGTH X (CM)	OUTPUT CAPACITOR C11 AND C12	COMMON-MODE CHOKE T1	LCR FILTER L1, L2, C7, C8, C9, C13, C14, R2, R3
X < 10	—	—	—
10 < X < 15	Required (100pF)	—	—
15 < X < 30	Required (100pF)	Required	—
X > 30	—	—	Required*

*When an LCR filter is required, remove C11, C12 and T1, short T1-1 to T1-4, short T1-2 to T1-3.

MAX9700B Evaluation Kit

Jumper Selection Shutdown Mode ($\overline{\text{SHDN}}$)

Jumper JU1 controls the shutdown pin ($\overline{\text{SHDN}}$) of the MAX9700B IC. See Table 3 for shunt positions.

Table 3. JU1 Jumper Selection

SHUNT POSITION	EV KIT FUNCTION
1-2 ($\overline{\text{SHDN}}$ = high)	EV kit enabled
2-3 ($\overline{\text{SHDN}}$ = low)	Shutdown mode
None. External controller connected to $\overline{\text{SHDN}}$ pad (TTL).	$\overline{\text{SHDN}}$ driven by external controller. Shutdown is active low.

Switching Frequency Mode (Sync)

Jumper JU2 provides an option to select the switching frequency of the MAX9700B IC. See Table 4 for the various shunt positions.

Table 4. JU2 Jumper Selection

SHUNT POSITION	MAX9700B SYNC PIN	INTERNAL OSCILLATOR FREQUENCY
1-2 (default)	SYNC pin = high	Spread-Spectrum Mode. Set at a switching frequency $f_{\text{sw}} = 1.22\text{MHz} \pm 120\text{kHz}$
1-3	SYNC pin = floating	Set at $f_{\text{NOM}} = 1.45\text{MHz}$
1-4	SYNC pin = external TTL-compatible clock input. External clock input connected to SYNC (TTL).	Synchronized to the incoming TTL-compatible clock frequency
1-5	SYNC = low	Set at the nominal

Input Mode

Jumper JU3 provides an option to select between a differential or single-ended input mode for the EV kit. See Table 5 for shunt positions.

Table 5. JU3 Jumper Selection

SHUNT POSITION	EV KIT INPUT MODE
None (default)	Differential Input Mode
Installed (IN- pad connected to GND)	Single-Ended Input Mode

Evaluating the MAX9700A/MAX9700C/MAX9700D and the MAX9712

The MAX9700B EV kit can evaluate the MAX9700A, MAX9700C, MAX9700D, and the MAX9712. To evaluate a different IC, replace U1 with the desired part. Refer to the MAX9700 or the MAX9712 data sheets for additional information.

Evaluates: MAX9700A/B/C/D/MAX9712

MAX9700B Evaluation Kit

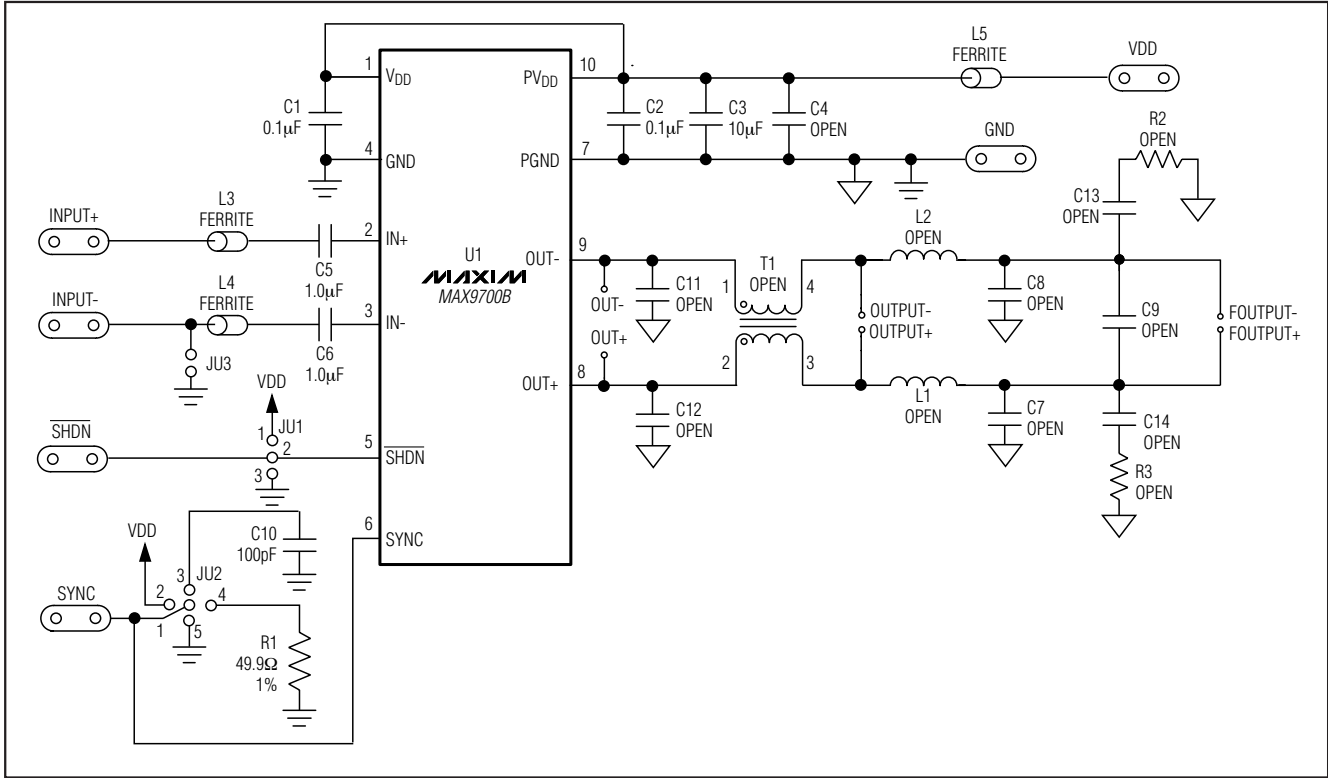

Figure 1. MAX9700B EV Kit Schematic

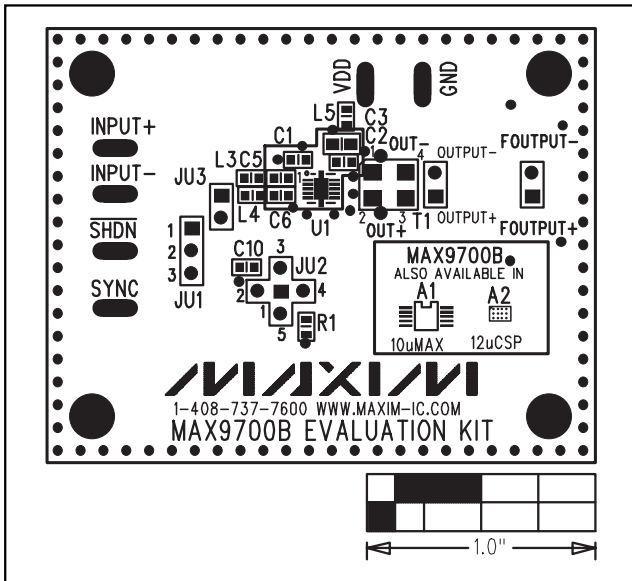

Figure 2. MAX9700B EV Kit Component Placement Guide—Component Side

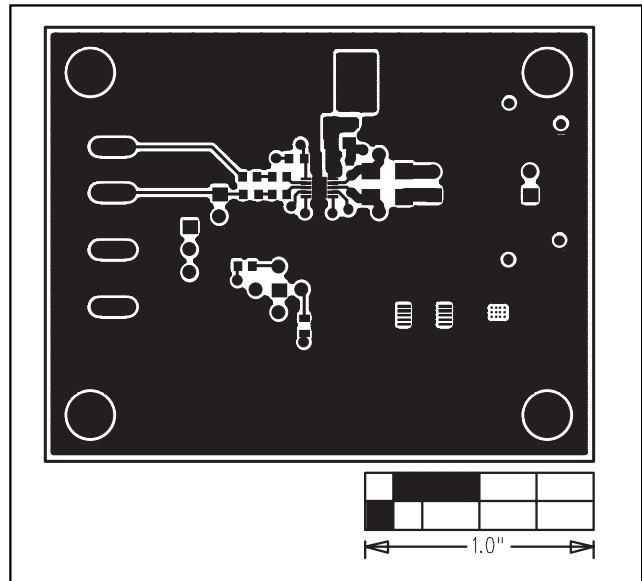

Figure 3. MAX9700B EV Kit PC Board Layout—Component Side

MAX9700B Evaluation Kit

Evaluates: MAX9700A/B/C/D/MAX9712

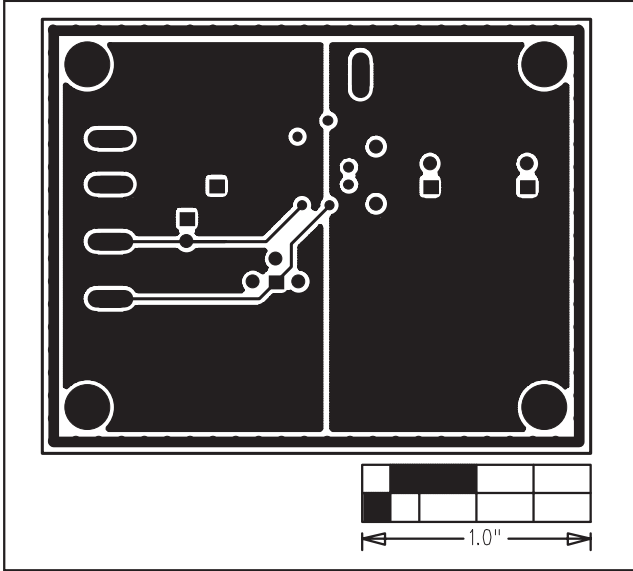

Figure 4. MAX9700B EV Kit PC Board Layout—GND Layer 2

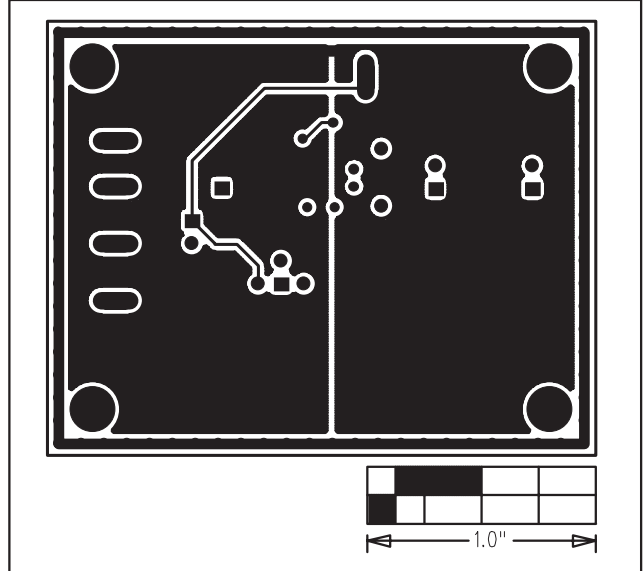

Figure 5. MAX9700B EV Kit PC Board Layout—GND Layer 3

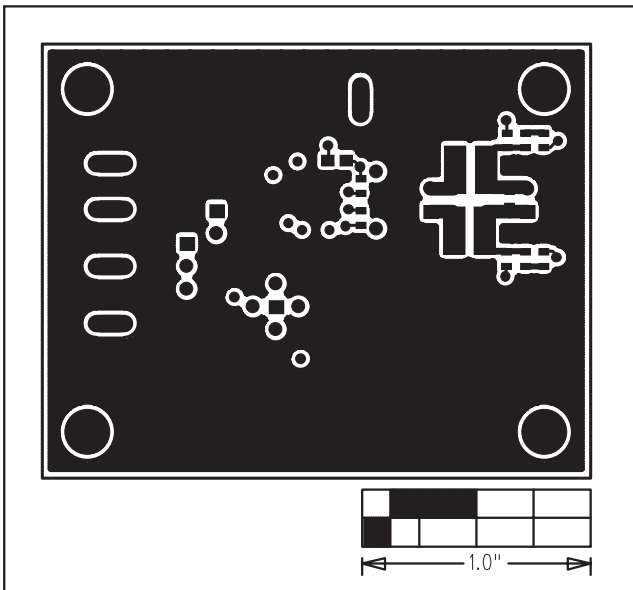

Figure 6. MAX9700B EV Kit PC Board Layout—Solder Side

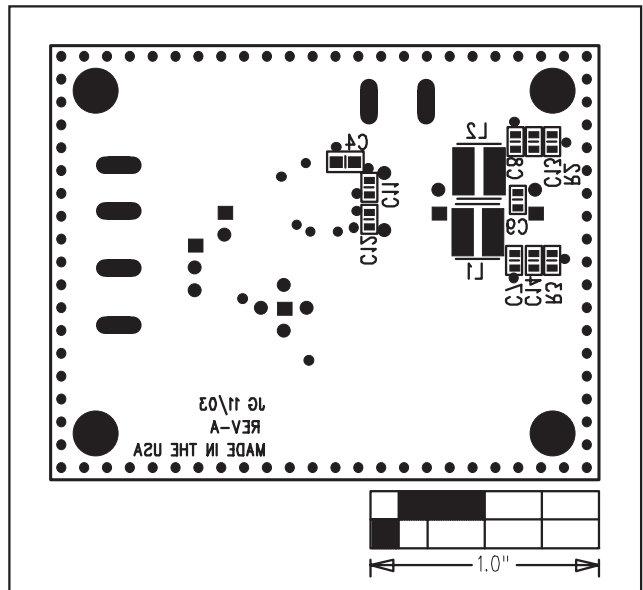

Figure 7. MAX9700B EV Kit Component Placement Guide—Solder Side

Maxim cannot assume responsibility for use of any circuitry other than circuitry entirely embodied in a Maxim product. No circuit patent licenses are implied. Maxim reserves the right to change the circuitry and specifications without notice at any time.

Maxim Integrated Products, 120 San Gabriel Drive, Sunnyvale, CA 94086 408-737-7600 _____ 5

Данный компонент на территории Российской Федерации

Вы можете приобрести в компании MosChip.

Для оперативного оформления запроса Вам необходимо перейти по данной ссылке:

<http://moschip.ru/get-element>

Вы можете разместить у нас заказ для любого Вашего проекта, будь то серийное производство или разработка единичного прибора.

В нашем ассортименте представлены ведущие мировые производители активных и пассивных электронных компонентов.

Нашей специализацией является поставка электронной компонентной базы двойного назначения, продукции таких производителей как XILINX, Intel (ex.ALTERA), Vicor, Microchip, Texas Instruments, Analog Devices, Mini-Circuits, Amphenol, Glenair.

Сотрудничество с глобальными дистрибьюторами электронных компонентов, предоставляет возможность заказывать и получать с международных складов практически любой перечень компонентов в оптимальные для Вас сроки.

На всех этапах разработки и производства наши партнеры могут получить квалифицированную поддержку опытных инженеров.

Система менеджмента качества компании отвечает требованиям в соответствии с ГОСТ Р ИСО 9001, ГОСТ РВ 0015-002 и ЭС РД 009

Офис по работе с юридическими лицами:

105318, г.Москва, ул.Щербаковская д.3, офис 1107, 1118, ДЦ «Щербаковский»

Телефон: +7 495 668-12-70 (многоканальный)

Факс: +7 495 668-12-70 (доб.304)

E-mail: info@moschip.ru

Skype отдела продаж:

moschip.ru

moschip.ru_4

moschip.ru_6

moschip.ru_9