

# Tall Stacker Connector: BTB

00-9148



AVX extends their range of board-to-board stacker connectors used to connect two PCB's, with a new tall version 00-9148. This new connector is designed to connect 2 parallel boards using a 1-piece connector design for board spacing of 8mm in a double row configuration offering 8 positions at 1mm pitch. With a rated current of 1A continuous through each contact.

Flexible tooling means that versions for board spacing between 4-12mm can be accommodated, with single row (4-16 positions) or double row (8-32 positions) options all on the same 1mm contact pitch. Options can also include bosses for mechanical stability, if required.

The connector is designed for surface mounting and supplied in tape and reel packaging. It mates with gold plated pads on the mating board surface. The tall stacker connector 00-9148 is suitable for wide range of applications including harsh environments such as those encountered in the automotive industry. It is a cost effective, reliable and robust BTB solution proven over time with 50 mating operations, high temperature nylon plastic and gold plated beryllium copper contacts for RoHS soldering.

This connector can be also customized to suit your application, with various number of rows / positions or stacking heights.

## APPLICATIONS

- Automotive applications such as entertainment systems
- Handheld/portable devices requiring docking or cradle charging
- Patient monitoring or portable medical electronics
- Industrial devices requiring pluggable or programming modules
- Internet appliances requiring battery back-up

## FEATURES AND BENEFITS

- Reduced assembly time
- Only one part to purchase and stock
- Extremely robust when subjected to shock and vibration
- Helps reduce tolerance accumulation within system
- Many options for customized versions

## ELECTRICAL

- Current Rating: 1 Amp continuous through all contacts
- Voltage Rating: 125 VAC

## ENVIRONMENTAL

- Operating Temperature: -40°C to +125°C

## MECHANICAL

- Insulator Material: High Temperature Plastic to UL94V0
- Contact Material: Beryllium Copper
- Plating: Gold on Nose, Pure Tin SMT terminations over base Nickel
- Durability: 50 Cycles

## HOW TO ORDER

**00**  
Prefix  
Board to  
Board  
Connector

**9148**  
Series

**008**  
Number  
of Ways  
008 = 8

**080**  
Stacking Height  
080 = 8mm

**2**  
Number of Rows  
2 = Double Row

**X**  
With or Without  
Boss  
0 = Without Boss

**X**  
With or Without Boss  
Plating Option  
6 = 0.25µm Gold on Nose, Standard  
8 = 0.80µm Gold on Nose,  
Special order only



# Tall Stacker Connector: BTB

00-9148

## 8-WAY – 8MM STACKING HEIGHT

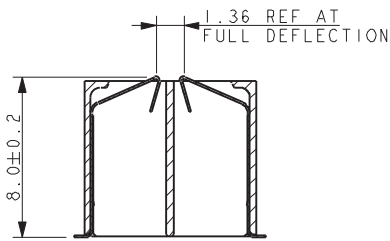
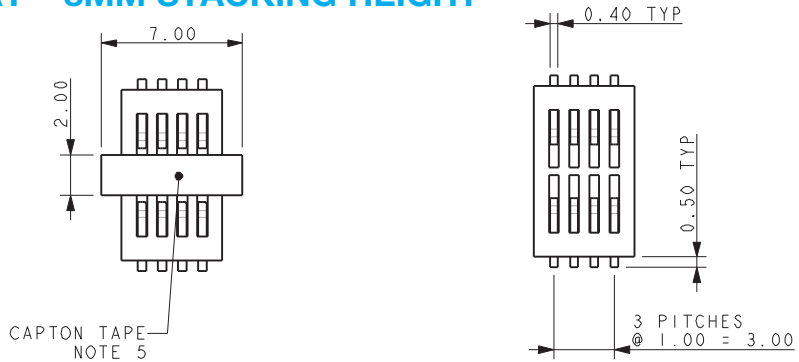
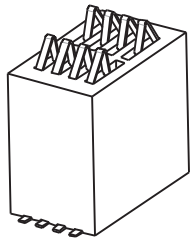

**SECTION ON A-A FULL DEFLECTION**

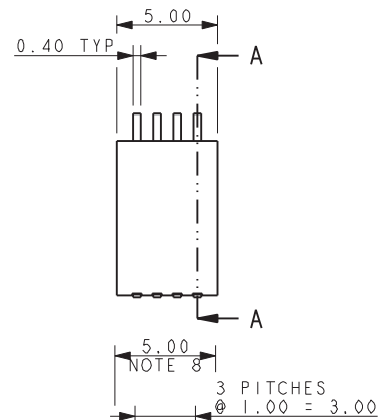
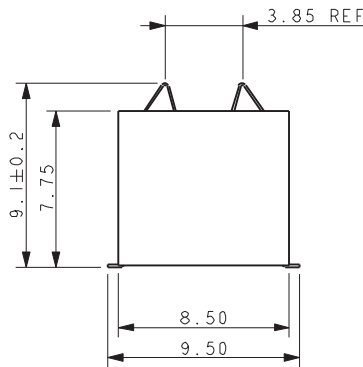

## PACKING DETAILS

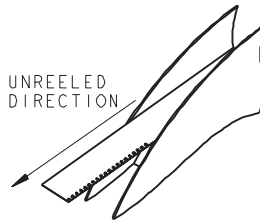
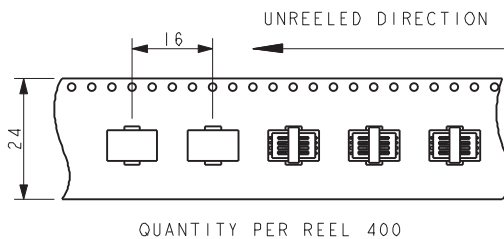

8 PADS 0.6 x 1.25

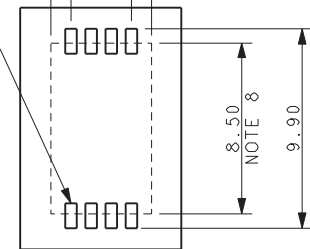

**SMT PCB FOOTPRINT**

### NOTES:

- SALES DRAWING FOR 8 WAY DOUBLE ROW STACKER AVX SERIES 9148.
- FOR PRODUCT SPECIFICATION REFER TO ELCO SPEC 201-01-173.
- MATERIALS:  
INSULATOR: NYLON 46, CLASS FILLED, UL94 V0. COLOR BLACK  
CONTACT: BERYLLIUM COPPER STRIP 0.1mm THICK  
PLATING: 1.00µm MAX NICKEL ALL OVER, 2.00-4.00 µm PURE TIN TAIL 0.25 µm GOLD NOSE STANDARD (REFER TO PAGE 1).
- PART TO BE PACKED IN TAPE AND REEL. QTY PER REEL: 400.
- SUPPLIED WITH CATON TAPE TO AID PICK AND PLACE, TO BE REMOVED AFTER RE-FLOW OPERATION.
- GENERAL TOLERANCE ±0.20 (UNLESS OTHERWISE STATED).
- PCB STACKED HEIGHT 8.00±0.20.
- CONNECTOR OUTLINE.

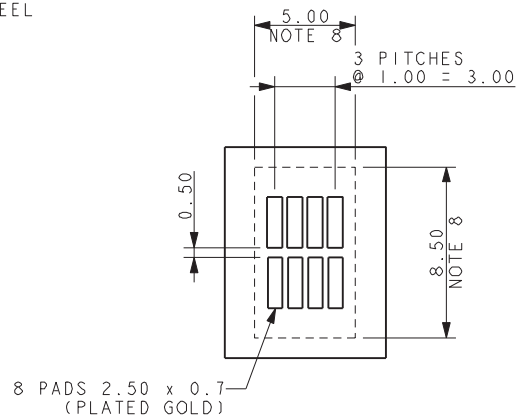

**MATING PCB LAYOUT**

## Данный компонент на территории Российской Федерации

### Вы можете приобрести в компании MosChip.

Для оперативного оформления запроса Вам необходимо перейти по данной ссылке:

<http://moschip.ru/get-element>

Вы можете разместить у нас заказ для любого Вашего проекта, будь то серийное производство или разработка единичного прибора.

В нашем ассортименте представлены ведущие мировые производители активных и пассивных электронных компонентов.

Нашей специализацией является поставка электронной компонентной базы двойного назначения, продукции таких производителей как XILINX, Intel (ex.ALTERA), Vicor, Microchip, Texas Instruments, Analog Devices, Mini-Circuits, Amphenol, Glenair.

Сотрудничество с глобальными дистрибьюторами электронных компонентов, предоставляет возможность заказывать и получать с международных складов практически любой перечень компонентов в оптимальные для Вас сроки.

На всех этапах разработки и производства наши партнеры могут получить квалифицированную поддержку опытных инженеров.

Система менеджмента качества компании отвечает требованиям в соответствии с ГОСТ Р ИСО 9001, ГОСТ РВ 0015-002 и ЭС РД 009

### Офис по работе с юридическими лицами:

105318, г.Москва, ул.Щербаковская д.3, офис 1107, 1118, ДЦ «Щербаковский»

Телефон: +7 495 668-12-70 (многоканальный)

Факс: +7 495 668-12-70 (доб.304)

E-mail: [info@moschip.ru](mailto:info@moschip.ru)

Skype отдела продаж:

moschip.ru

moschip.ru\_4

moschip.ru\_6

moschip.ru\_9