

SSL - Discrete Wire IDC



Series 9177



The 917X series of surface mount Insulation Displacement Connectors (IDC) were developed to meet the harsh automotive and industrial market applications for connecting individual wires directly to a PCB ranging from 14 AWG to 28 AWG. This industry proven contact system has been tested to automotive levels of shock, vibration, and temperature cycling to prove their reliability and robustness. The simplicity of inserting a wire into the connector with a small tool allows a wide range of devices to be connected to the PCB without soldering. In SSL applications specifically, these connectors are used to bring power and signal onto the PCB or are used to daisy chain multiple boards together in a long string. While the IDC contact provides a gas-tight connection to conductor of the wire, the housing has been designed to grab the insulation of the wire to provide a positive strain relief even in the harshest conditions. In case of repair, the wires can be removed and replace up to three times.

The 9177 series accepts 14 AWG to 20 AWG wires with an insulation diameter ranging from 2.75mm to 4.25mm. These dual contact connectors support a 15 amp current rating with two large SMT solder tails per wire to provide maximum stability on the PCB. Available in 1p-3p configuration, these connectors can be end stackable for higher pin counts.

APPLICATIONS

- Connecting discrete wire components directly to the PCB
- Bringing power and signals onto a PCB
- Daisy chaining PCB's together to create a continuous string of boards
- Application Notes: refer to 201-01-124

FEATURES AND BENEFITS

- IDC contact provides a gas-tight connection to the PCB for long term reliability
- Connector housing captures the wire insulation for positive strain relief
- Tested to automotive levels on shock, vibration and temperature cycling for reliability
- Low and high volume assembly tools to match production volumes
- Reduced total applied cost versus solder or crimp processes
- High temperature insulator capable to 260°C reflow soldering processes

ELECTRICAL

- Current Rating: 15 Amp / Contact
- Voltage Rating: 600 VAC

ENVIRONMENTAL

- Operating Temperature: -40°C to +125°C

MECHANICAL

- Insulator Material: Nylon 46: UL94V0
- Contact Material: Phosphor Bronze
- Plating: Tin over Nickel
- Durability: 3 Cycles

HOW TO ORDER

00
Prefix

9177
Series

00X
Number of Ways

| Code | No of Ways | Details |
|------|------------|---------|
| 001 | 1 | Page 62 |
| 002 | 2 | Page 63 |
| 003 | 3 | Page 64 |

00X
Wire Gauge Size

| Code | Accepted Wire Gauge | Wire Insulation |
|------|---------------------|-----------------|
| 001 | 14 AWG | Ø 4.25 |
| 012 | 16 AWG | Ø 3.50 |
| 022 | 18 AWG | Ø 3.50 |
| 033 | 20 AWG | Ø 2.75 |

X
Insulator Color

| Code | Color | Application |
|------|-------|-------------|
| 0 | Black | Industrial |
| 1 | White | Lighting |

06
Plating Option
06 = Pure Tin all over

Certification: UL File #E320991



SSL - Discrete Wire IDC



Series 9177

14-20 AWG 1 WAY IDC CONNECTOR



NOTES:

1. CONNECTOR FOR IDC WIRE TO BOARD CONNECTION.
2. CONTACT MATERIAL: PHOSPHORE BRONZE.
INSULATION MATERIAL: HIGH TEMPERATURE NYLON 46.
COLOR REFER TO PAGE 61.
3. CONNECTOR DESIGNED TO ACCEPT BETWEEN 14 AND 20 GAUGE STRANDED WIRE.
4. ALL DIMENSIONS FOR REFERENCE UNLESS OTHERWISE STATED.
5. FOR FULL PRODUCT SPECIFICATION REFER TO ELCO SPEC 201-01-109.
6. FOR PCB SPACE RESTRICTED BY ASSEMBLY TOOLING REFER TO PAGE 65.



| Code | Accepted Wire Gauge | A | Wire Insulation | B |
|------|---------------------|------|-----------------|------|
| 001 | 14 Gauge Stranded | 1.10 | Ø 4.25 max | 4.25 |
| 012 | 16 Gauge Stranded | 0.82 | Ø 3.50 max | 3.50 |
| 022 | 18 Gauge Stranded | 0.72 | Ø 3.50 max | 3.50 |
| 033 | 20 Gauge Stranded | 0.60 | Ø 2.75 max | 2.75 |



SMT PCB LAYOUT

PURE TIN PADS



PACKING DETAILS

| | |
|----------|-------|
| REEL QTY | 400 |
| LEADER | 500MM |
| TRAILER | 400MM |
| REEL/BOX | 4 |
| PACK QTY | 1600 |

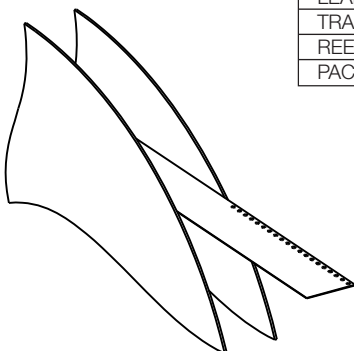

SSL - Discrete Wire IDC



Series 9177

14-20 AWG 2 WAY IDC CONNECTOR



NOTES:

- CONNECTOR FOR IDC WIRE TO BOARD CONNECTION.
- CONTACT MATERIAL: PHOSPHORE BRONZE.
INSULATION MATERIAL: HIGH TEMPERATURE NYLON 46.
COLOR REFER TO PAGE 61.
- CONNECTOR DESIGNED TO ACCEPT BETWEEN 14 AND 20 GAUGE STRANDED WIRE.
- ALL DIMENSIONS FOR REFERENCE UNLESS OTHERWISE STATED.
- FOR FULL PRODUCT SPECIFICATION REFER TO ELCO SPEC 201-01-109.
- FOR PCB SPACE RESTRICTED BY ASSEMBLY TOOLING REFER TO PAGE 65.



| Code | Accepted Wire Gauge | A | Wire Insulation | B |
|------|---------------------|------|-----------------|------|
| 001 | 14 Gauge Stranded | 1.10 | Ø 4.25 max | 4.25 |
| 012 | 16 Gauge Stranded | 0.82 | Ø 3.50 max | 3.50 |
| 022 | 18 Gauge Stranded | 0.72 | Ø 3.50 max | 3.50 |
| 033 | 20 Gauge Stranded | 0.60 | Ø 2.75 max | 2.75 |



SMT PCB LAYOUT

PURE TIN PADS



PACKING DETAILS

| | |
|----------|-------|
| REEL QTY | 400 |
| LEADER | 500MM |
| TRAILER | 400MM |
| REEL/BOX | 4 |
| PACK QTY | 1600 |



SSL - Discrete Wire IDC



Series 9177

14-20 AWG 3 WAY IDC CONNECTOR

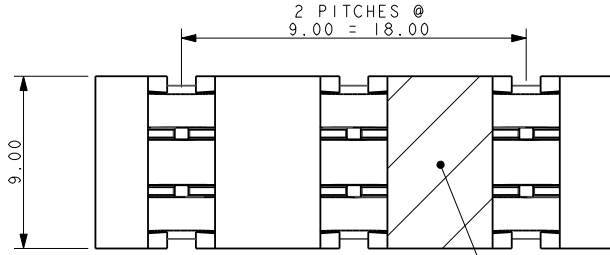

NOTES:

1. CONNECTOR FOR IDC WIRE TO BOARD CONNECTION.
2. CONTACT MATERIAL: PHOSPHORE BRONZE.
INSULATION MATERIAL: HIGH TEMPERATURE NYLON 46.
COLOR REFER TO PAGE 61.
3. CONNECTOR DESIGNED TO ACCEPT BETWEEN 14 AND 20 GAUGE STRANDED WIRE.
4. ALL DIMENSIONS FOR REFERENCE UNLESS OTHERWISE STATED.
5. FOR FULL PRODUCT SPECIFICATION REFER TO ELCO SPEC 201-01-109.
6. FOR PCB SPACE RESTRICTED BY ASSEMBLY TOOLING REFER TO PAGE 65.



PICK UP AREA 4.75 x 9.00mm MIN

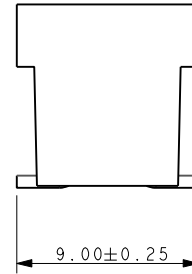

| Code | Accepted Wire Gauge | A | Wire Insulation | B |
|------|---------------------|------|-----------------|------|
| 001 | 14 Gauge Stranded | 1.10 | Ø 4.25 max | 4.25 |
| 012 | 16 Gauge Stranded | 0.82 | Ø 3.50 max | 3.50 |
| 022 | 18 Gauge Stranded | 0.72 | Ø 3.50 max | 3.50 |
| 033 | 20 Gauge Stranded | 0.60 | Ø 2.75 max | 2.75 |



SMT PCB LAYOUT

PURE TIN PADS



PACKING DETAILS

| | |
|----------|-------|
| REEL QTY | 400 |
| LEADER | 500MM |
| TRAILER | 400MM |
| REEL/BOX | 4 |
| PACK QTY | 1600 |



SSL - Discrete Wire IDC



Series 9177

INSERTION TOOLING – REQUIRES HAND PRESS WITH FLAT ROCK PLATES

1 WAY

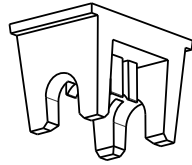

2 WAY

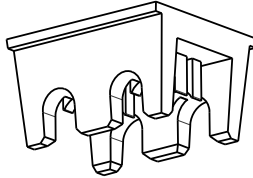

3 WAY

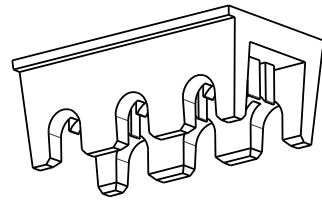

HIGH PRODUCTION

| No. of Ways | Max Insulation Dia (AWG) | Tool Part Number |
|-------------|--------------------------|---------------------|
| 1 | 4.25 (14) | 06 9177 7017 01 001 |
| | 3.50 (16-18) | 06 9177 7017 02 001 |
| | 2.75 (20) | 06 9177 7017 03 001 |
| 2 | 4.25 (14) | 06 9177 7017 01 002 |
| | 3.50 (16-18) | 06 9177 7017 02 002 |
| | 2.75 (20) | 06 9177 7017 03 002 |
| 3 | 4.25 (14) | 06 9177 7017 01 003 |
| | 3.50 (16-18) | 06 9177 7017 02 003 |
| | 2.75 (20) | 06 9177 7017 03 003 |

MEDIUM PRODUCTION Plastic

| No. of Ways | Max Insulation Dia (AWG) | Tool Part Number |
|-------------|--------------------------|---------------------|
| 1 | 4.25 (14) | 06 9177 7016 01 001 |
| | 3.50 (16-18) | 06 9177 7016 02 001 |
| | 2.75 (20) | 06 9177 7016 03 001 |
| 2 | 4.25 (14) | 06 9177 7016 01 002 |
| | 3.50 (16-18) | 06 9177 7016 02 002 |
| | 2.75 (20) | 06 9177 7016 03 002 |
| 3 | 4.25 (14) | 06 9177 7016 01 003 |
| | 3.50 (16-18) | 06 9177 7016 02 003 |
| | 2.75 (20) | 06 9177 7016 03 003 |

The assembly tooling restricts the available space/component heights on the PCB.
For details see below.

NOTES:

1. ALL DIMENSIONS FOR REFERENCE DIMENSIONS.
2. MAXIMUM COMPONENT HEIGHT 0.80MM IN THIS AREA.
3. MAXIMUM COMPONENT HEIGHT 11.00 MM IN THIS AREA.
4. THE SAME RESTRICTIONS APPLY TO ALL WIRE INSULATION DIAMETERS.

INSERTION TOOLING – PCB RESTRICTED AREAS FOR ASSEMBLY TOOLING

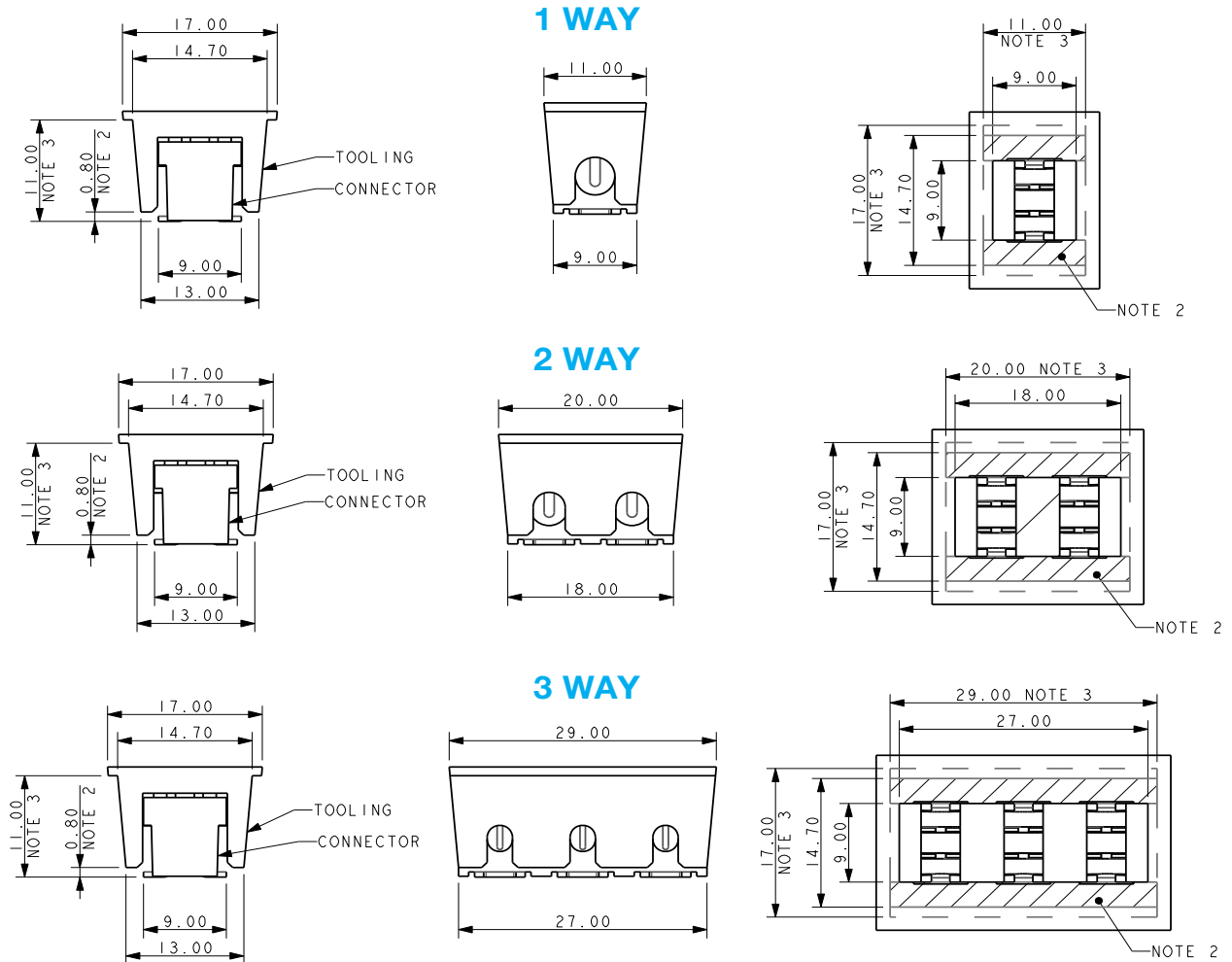

Данный компонент на территории Российской Федерации

Вы можете приобрести в компании MosChip.

Для оперативного оформления запроса Вам необходимо перейти по данной ссылке:

<http://moschip.ru/get-element>

Вы можете разместить у нас заказ для любого Вашего проекта, будь то серийное производство или разработка единичного прибора.

В нашем ассортименте представлены ведущие мировые производители активных и пассивных электронных компонентов.

Нашей специализацией является поставка электронной компонентной базы двойного назначения, продукции таких производителей как XILINX, Intel (ex.ALTERA), Vicor, Microchip, Texas Instruments, Analog Devices, Mini-Circuits, Amphenol, Glenair.

Сотрудничество с глобальными дистрибьюторами электронных компонентов, предоставляет возможность заказывать и получать с международных складов практически любой перечень компонентов в оптимальные для Вас сроки.

На всех этапах разработки и производства наши партнеры могут получить квалифицированную поддержку опытных инженеров.

Система менеджмента качества компании отвечает требованиям в соответствии с ГОСТ Р ИСО 9001, ГОСТ РВ 0015-002 и ЭС РД 009

Офис по работе с юридическими лицами:

105318, г.Москва, ул.Щербаковская д.3, офис 1107, 1118, ДЦ «Щербаковский»

Телефон: +7 495 668-12-70 (многоканальный)

Факс: +7 495 668-12-70 (доб.304)

E-mail: info@moschip.ru

Skype отдела продаж:

moschip.ru

moschip.ru_4

moschip.ru_6

moschip.ru_9