



### »» Features

- ISO 280 footprint design.
- High temperature endurance up to 125 degree C.
- Optional SPNC, SPNO, SPDT contact configurations.
- Optional to be equipped with protection diode or resistor.
- Available for dust cover type, skirted cover flanged cover, and weather proof versions.
- Comply with RoHS-Directive 2002/95/EC, and ELV-Directive 2000/53/EC.

### »» Type List

Terminal style	Contact form	Enclosure style		
		Dust cover	Flux tight	Sealed type washable
Socket terminal	1A (SPNO)	898-1AH-D	898-1AH-C	898-1AH-S
		898H-1AH-D	898H-1AH-C	898H-1AH-S
	1C (SPDT)	898-1CH-D	898-1CH-C	898-1CH-S
		898H-1CH-D	898H-1CH-C	898H-1CH-S

Terminal style	Contact form	Enclosure style	
		Flanged cover (dust cover)	Flanged cover (flux tight)
Socket terminal	1A (SPNO)	898-1AH-D1	898-1AH-C1
		898H-1AH-D1	898H-1AH-C1
	1C (SPDT)	898-1CH-D1	898-1CH-C1
		898H-1CH-D1	898H-1CH-C1

Terminal style	Contact form	Enclosure style	
		Steel bracket (dust cover)	Steel bracket (flux tight)
Socket terminal	1A (SPNO)	898-1AH-D1S	898-1AH-C1S
		898H-1AH-D1S	898H-1AH-C1S
	1C (SPDT)	898-1CH-D1S	898-1CH-C1S
		898H-1CH-D1S	898H-1CH-C1S

Terminal style	Contact form	Designation (provided with)	Enclosure style	
			Steel bracket (dust cover with shroud)	Steel bracket (dust cover with weather proof)
Socket terminal	1C (SPDT)	Resistor	898H-1CH-D1SF-R1	898H-1CH-D1SW-R1



### Ordering Information

898      H   -  1CH   -  C   -  R1      001  
 1        2        3        4        5        6

- |                                                                                                                                                                                                                                                                                                                                                                                                                                                                                                        |                                                                                                                                                                                                                                                                                                                                                                                                                                                                                                                                              |
|--------------------------------------------------------------------------------------------------------------------------------------------------------------------------------------------------------------------------------------------------------------------------------------------------------------------------------------------------------------------------------------------------------------------------------------------------------------------------------------------------------|----------------------------------------------------------------------------------------------------------------------------------------------------------------------------------------------------------------------------------------------------------------------------------------------------------------------------------------------------------------------------------------------------------------------------------------------------------------------------------------------------------------------------------------------|
| <p>1. 898 -- Basic series designation</p> <p>2. Blank -- Standard type<br/>H -- High power type</p> <p>3. 1AH -- Single pole normally open, contact material AgSnO<br/>1BH -- Single pole normally closed, contact material AgSnO<br/>1CH -- Single pole double throw, contact material AgSnO</p> <p>4. D -- Dust cover<br/>C -- Flux tight<br/>S -- Sealed type washable<br/>D1 -- Flanged cover (dust cover)<br/>C1 -- Flanged cover (flux tight)<br/>S1 -- Flanged cover (sealed type washable)</p> | <p>D1S -- Steel bracket (dust cover)<br/>C1S -- Steel bracket (flux tight)<br/>S1S -- Steel bracket (sealed type washable)<br/>D1SF -- Steel bracket (Dust cover with shroud)<br/>D1SW -- Steel bracket (Dust cover with weather proof)</p> <p>5. Blank -- Standard type<br/>R1 -- Coil parallel with resistor 1/2W for 12V 680Ω, 24V 2700Ω</p> <p>6. Blank -- Standard type<br/>001 -- Coil parallel with diode IN4007 the positive pole on # 85 terminal<br/>002 -- Coil parallel with diode IN4007 the negative pole on # 85 terminal</p> |
|--------------------------------------------------------------------------------------------------------------------------------------------------------------------------------------------------------------------------------------------------------------------------------------------------------------------------------------------------------------------------------------------------------------------------------------------------------------------------------------------------------|----------------------------------------------------------------------------------------------------------------------------------------------------------------------------------------------------------------------------------------------------------------------------------------------------------------------------------------------------------------------------------------------------------------------------------------------------------------------------------------------------------------------------------------------|

### Contact Rating

Resistive load	898 1A	898 1B	898 1C
	40A 14VDC	40A 14VDC	NO : 30A 14VDC NC : 20A 14VDC
	898H 1A	898H 1B	898H 1C
	50A 14VDC 20A 28VDC	40A 14VDC 15A 28VDC	NO: 50A 14VDC, 20A 28VDC NC: 30A 14VDC, 15A 28VDC

### Coil Rating (DC)

Rated voltage (V)	Rated current ±10 % at 23°C (mA)	Coil resistance ±10 % at 23°C (Ω)	Max. continuous voltage at 85°C <sup>(1)</sup>	Pick up voltage(Max) at 23°C	Drop out voltage(Min) at 23°C	Power consumption at rated voltage
12	133	90	120 % of rated voltage	65 % of rated voltage	10 % of rated voltage	approx. 1.6W
24	66.7	360				

Notes : (1) Without switching the load.

### »» Specification

Contact material	AgSnO alloy	
Contact voltage drop <sup>(1)</sup>	Typ. 50mV at 10A	
Insulation resistance <sup>(1)</sup>	20MΩ Min. (DC 500V)	
Operate time <sup>(1)</sup>	20ms Max.	
Release time <sup>(1)</sup>	20ms Max.	
Dielectric strength <sup>(1)</sup>	Between open contact	: AC 500V , 50/60Hz 1 min.
	Between contact and coil	: AC 500V , 50/60Hz 1 min.
Vibration resistance	Operating extremes	10~55Hz , amplitude 2mm
Shock resistance	Operating extremes	10G
	Damage limits	100G
Life expectancy	Mechanical	10,000,000 operations (frequency 18,000 operations/hr)
	Electrical	100,000 operations (frequency 1,200 operations/hr)
Temperature range	Operating	-40~+125°C (no freezing)
Weight	Approx. 40 g	

Note : (1) initial value

### »» Outline Dimensions

#### ◆ 898,898H(C,D,S)



#### ◆ 898,898H(C1,D1,S1)

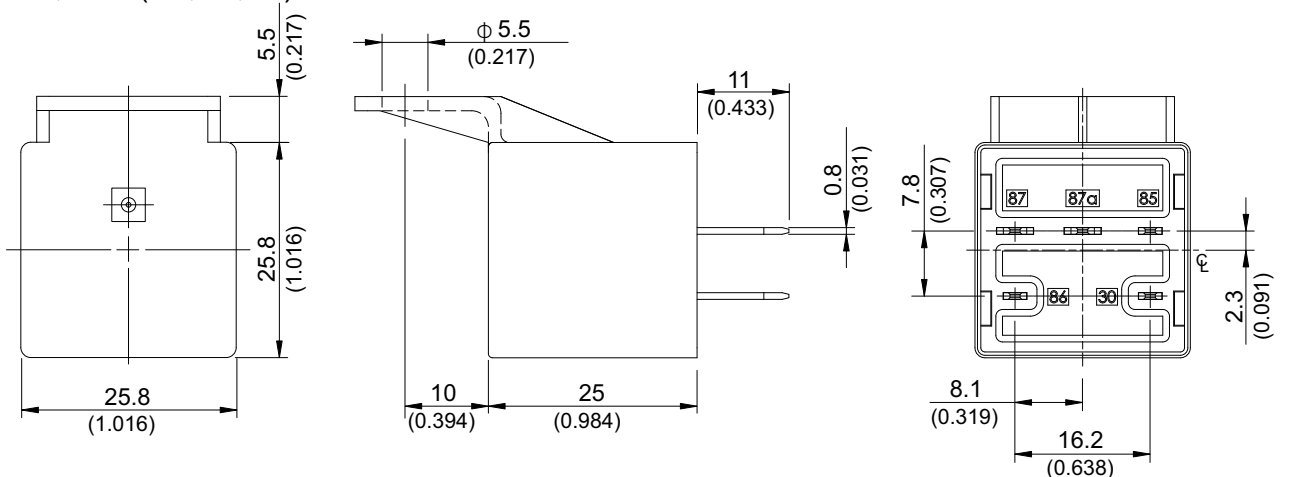

**◆ 898, 898H (C1S, D1S, S1S)**

**◆ 898H (D1SW)**

**◆ 898H (D1SF)**

## »» Wiring Diagram

BOTTOM VIEW

1A



1B



1C

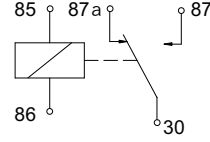

R1

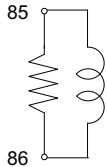

001

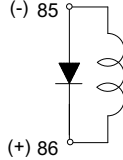

002

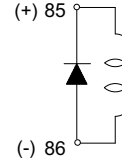

## »» Engineering Data

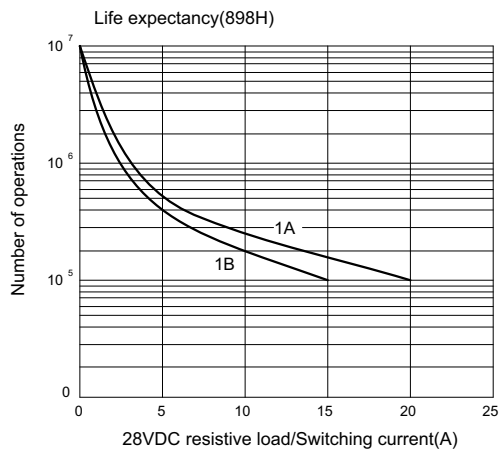
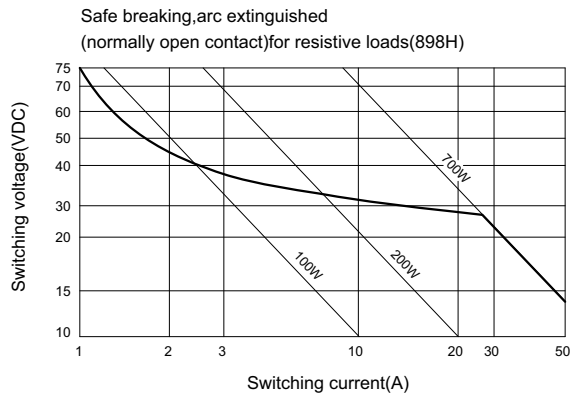

## Данный компонент на территории Российской Федерации

### Вы можете приобрести в компании MosChip.

Для оперативного оформления запроса Вам необходимо перейти по данной ссылке:

<http://moschip.ru/get-element>

Вы можете разместить у нас заказ для любого Вашего проекта, будь то серийное производство или разработка единичного прибора.

В нашем ассортименте представлены ведущие мировые производители активных и пассивных электронных компонентов.

Нашей специализацией является поставка электронной компонентной базы двойного назначения, продукции таких производителей как XILINX, Intel (ex.ALTERA), Vicor, Microchip, Texas Instruments, Analog Devices, Mini-Circuits, Amphenol, Glenair.

Сотрудничество с глобальными дистрибьюторами электронных компонентов, предоставляет возможность заказывать и получать с международных складов практически любой перечень компонентов в оптимальные для Вас сроки.

На всех этапах разработки и производства наши партнеры могут получить квалифицированную поддержку опытных инженеров.

Система менеджмента качества компании отвечает требованиям в соответствии с ГОСТ Р ИСО 9001, ГОСТ РВ 0015-002 и ЭС РД 009

### Офис по работе с юридическими лицами:

105318, г.Москва, ул.Щербаковская д.3, офис 1107, 1118, ДЦ «Щербаковский»

Телефон: +7 495 668-12-70 (многоканальный)

Факс: +7 495 668-12-70 (доб.304)

E-mail: [info@moschip.ru](mailto:info@moschip.ru)

Skype отдела продаж:

moschip.ru

moschip.ru\_4

moschip.ru\_6

moschip.ru\_9