

# Universal Programmable Clock Generator (UPCG)

## Features

- Spread spectrum, VCXO, and frequency select
- Input frequency range:
  - Crystal: 8–30 MHz
  - CLKIN: 0.5–100 MHz
- Output frequency:
  - Commercial: 1–200 MHz
  - Industrial: 1–166 MHz
- Integrated phase-locked loop
- Low jitter, high accuracy outputs
- 3.3 V operation
- 8-pin SOIC package

## Functional Description

The CY22800 is a multi-function clock generator that supports various applications in consumer and communications markets. The device uses the Cypress proprietary PLL along with spread spectrum and VCXO technology to make it one of the most versatile clock synthesizers in the marketplace. The CY22800 is a field-programmable synthesizer that can be programmed using an easy-to-use programmer dongle, CY36800, with one of many predefined configuration files for fast sample generation of prototype builds. The CY22800 is a reprogrammable device that can be programmed up to 100 times. The latest configurations available for this device are summarized in [CY22800 Configurations on page 5](#).

For a complete list of related documentation, click [here](#).

## Logic Block Diagram

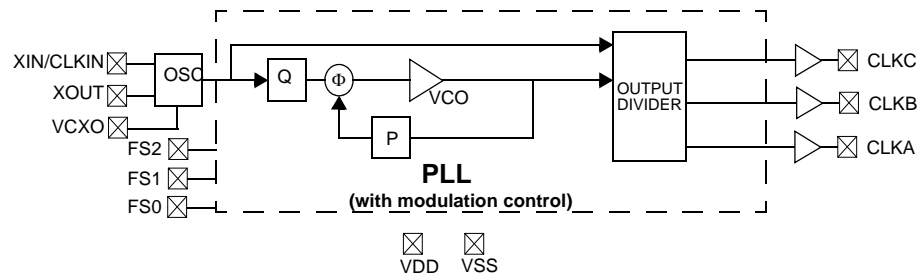

## Contents

<b>Pin Configurations</b> .....	<b>3</b>	<b>Test Circuit</b> .....	<b>13</b>
<b>Pin Definitions</b> .....	<b>3</b>	<b>Timing Definitions</b> .....	<b>13</b>
<b>Spread Spectrum Clock Generation (SSCG)</b> .....	<b>4</b>	<b>Ordering Information</b> .....	<b>14</b>
<b>VCXO</b> .....	<b>4</b>	Ordering Code Definitions .....	14
VCXO Profile .....	4	<b>Package Diagram</b> .....	<b>15</b>
<b>CY22800 Configurations</b> .....	<b>5</b>	<b>Acronyms</b> .....	<b>16</b>
<b>Cypress Programmable Clocks</b> .....	<b>10</b>	<b>Document Conventions</b> .....	<b>16</b>
<b>Absolute Maximum Conditions</b> .....	<b>11</b>	Units of Measure .....	16
<b>Recommended Operating Conditions</b> .....	<b>11</b>	<b>Document History Page</b> .....	<b>17</b>
<b>Pullable Crystal Specifications</b>		<b>Sales, Solutions, and Legal Information</b> .....	<b>18</b>
<b>for VCXO Application ONLY</b> .....	<b>11</b>	Worldwide Sales and Design Support .....	18
<b>Recommended Crystal Specifications</b>		Products .....	18
<b>for ALL other Applications</b> .....	<b>12</b>	PSoC Solutions .....	18
<b>DC Electrical Specifications</b> .....	<b>12</b>		
<b>AC Electrical Characteristics (<math>V_{DD} = 3.3\text{ V}</math>)</b> .....	<b>12</b>		

## Pin Configurations

Figure 1. CY22800 8-Pin SOIC (150 Mils) Pinout

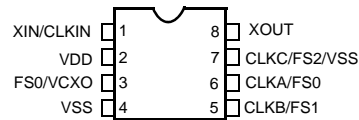

## Pin Definitions

Name	Pin Number	Description
XIN	1	Reference input; crystal or external clock
VDD	2	3.3 V voltage supply
FS0/VCXO	3	Frequency select 0/VCXO analog control voltage <sup>[1]</sup>
VSS	4	Ground
CLKB/FS1	5	Clock output B/frequency select 1 <sup>[1]</sup>
CLKA/FS0	6	Clock output A/frequency select 0 <sup>[1]</sup>
CLKC/FS2/VSS	7	Clock output C/frequency select 2/VSS <sup>[1]</sup>
XOUT	8	Reference output (No Connect when the reference is a clock)

**Note**

1. Pin definition changes for different configurations. Refer to the specific one-page data sheet for more details.

### Spread Spectrum Clock Generation (SSCG)

The CY22800 can generate spread spectrum clocks (SSCG) to reduce EMI found in today's high-speed digital electronic systems.

The device uses proprietary spread spectrum clock (SSC) technology to synthesize and modulate the frequency of the input clock. By modulating the frequency of the clock, the measured EMI at the fundamental and harmonic frequencies is greatly reduced. This reduction in radiated energy can significantly reduce the cost of complying with regulatory agency (EMC) requirements and improve time to market without degrading system performance.

The CY22800 uses a preprogrammed configuration of memory arrays to synthesize output frequency and offers eight different spread percentages (refer to the [CY22800 Configurations on page 5](#) – Code numbers -015 to -022), and an additional option to turn the spread on and off.

For the above-mentioned configurations, the modulation frequency varies with the reference frequency as follows:

$$f_{\text{mod}} = \frac{f_{\text{ref}}}{1000}$$

### VCXO

One of the key components of the CY22800 device is the VCXO. The VCXO is used to "pull" the reference crystal higher or lower in order to lock the system frequency to an external source. This

is ideal for applications where the output frequency needs to track along with an external reference frequency that is constantly shifting.

A special pullable crystal must be used in order to have adequate VCXO pull range. Pullable Crystal specifications are included in this data sheet.

### VCXO Profile

Figure 2 shows an example of what a VCXO profile looks like. The analog voltage input is on the X-axis and the PPM range is on the Y-axis. An increase in the VCXO input voltage results in a corresponding increase in the output frequency. This has the effect of moving the PPM from a negative to positive offset.

Figure 2. VCXO Profile

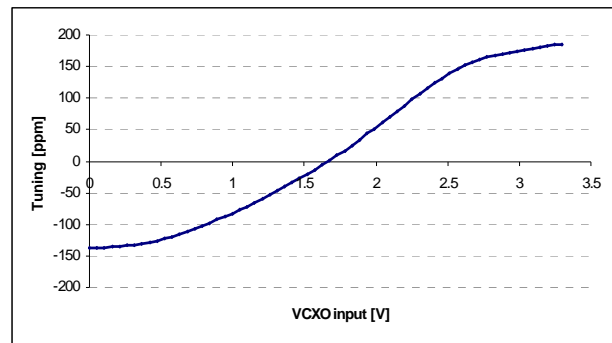

**CY22800 Configurations**

Code #	Code name	Input Freq. (MHz)	Output Freq. (MHz)	SS	VCXO
<b>Commercial Temperature Range</b>					
CY22800-001A	X2 Multiplier	CLKIN: 0.5–100 XTAL: 8–30	CLKA: 1–200 or REFOUT	N	N
CY22800-002A	X3 Multiplier	CLKIN: 0.5–66.66 XTAL: 8–30	CLKA: 1.5–200 or REFOUT	N	N
CY22800-003A	X4 Multiplier	CLKIN: 0.5–50 XTAL: 8–30	CLKA: 2–200 or REFOUT	N	N
CY22800-004A	X5 Multiplier	CLKIN: 0.5–40 XTAL: 8–30	CLKA: 2.5–200 or REFOUT	N	N
CY22800-005A	X6 Multiplier	CLKIN: 0.5–33.33 XTAL: 8–30	CLKA: 3–200 CLKB: REFOUT	N	N
CY22800-006A	X8 Multiplier	CLKIN: 0.5–25 XTAL: 8–25	CLKA: 4–200 CLKB: REFOUT	N	N
CY22800-007A	Clock multiplier for consumer & communication applications	14.318 <sup>[2]</sup>	CLKA: 33.33, 66.66, 50, 75, 80, 100, 133.33 See D/S	N	N
CY22800-008A	Clock multiplier for consumer & communication applications	14.318 <sup>[2]</sup>	CLKA: 12, 24, 48, 60, 62.5, 106.25, 125 See D/S	N	N
CY22800-009A	Clock multiplier for consumer & communication applications	20 <sup>[2]</sup>	CLKA: 33.33, 66.66, 50, 75, 80, 100, 133.33 See D/S	N	N
CY22800-010A	Clock multiplier for consumer & communication applications	20 <sup>[2]</sup>	CLKA: 12, 24, 48, 60, 62.5, 106.25, 125 See D/S	N	N
CY22800-011A	Clock multiplier for consumer & communication applications	25 <sup>[2]</sup>	CLKA: 33.33, 66.66, 50, 75, 80, 100, 133.33 See D/S	N	N
CY22800-012A	Clock multiplier for consumer & communication applications	25 <sup>[2]</sup>	CLKA: 12, 24, 48, 60, 62.5, 106.25, 125 See D/S	N	N
CY22800-013A	Clock multiplier for consumer & communication applications	27 <sup>[2]</sup>	CLKA: 33.33, 66.66, 50, 75, 80, 100, 133.33 See D/S	N	N
CY22800-014A	Clock multiplier for consumer & communication applications	27 <sup>[2]</sup>	CLKA: 12, 24, 48, 60, 62.5, 106.25, 125 See D/S	N	N

**Note**

2. Fixed CLKIN/Xtal frequency. Refer to the one page data sheet corresponding to the Code # for detailed input and output ranges.

**CY22800 Configurations** *(continued)*

Code #	Code name	Input Freq. (MHz)	Output Freq. (MHz)	SS	VCXO
CY22800-015A	Spread spectrum for consumer and communication applications	CLKIN: 25.0–100.0 XTAL: 25.0–30.0	CLKA: REF (spread $\pm 0.25\%$ or off) CLKB: REF or REF/2 (spread $\pm 0.25\%$ or off)	Y	N
CY22800-016A	Spread spectrum for consumer and communication applications	CLKIN: 25.0–100.0 XTAL: 25.0–30.1	CLKA: REF (spread $\pm 0.5\%$ or off) CLKB: REF or REF/2 (spread $\pm 0.5\%$ or off)	Y	N
CY22800-017A	Spread spectrum for consumer and communication applications	CLKIN: 25.0–100.0 XTAL: 25.0–30.0	CLKA: REF (spread $\pm 0.75\%$ or off) CLKB: REF or REF/2 (spread $\pm 0.75\%$ or off)	Y	N
CY22800-018A	Spread spectrum for consumer and communication applications	CLKIN: 25.0–100.0 XTAL: 25.0–30.3	CLKA: REF (spread $\pm 1.0\%$ or off) CLKB: REF or REF/2 (spread $\pm 1.0\%$ or off)	Y	N
CY22800-019A	Spread spectrum for consumer and communication applications	CLKIN: 25.0–100.0 XTAL: 25.0–30.0	CLKA: REF (spread $\pm 1.25\%$ or off) CLKB: REF or REF/2 (spread $\pm 1.25\%$ or off)	Y	N
CY22800-020A	Spread spectrum for consumer and communication applications	CLKIN: 25.0–100.0 XTAL: 25.0–30.0	CLKA: REF (spread $\pm 1.5\%$ or off) CLKB: REF or REF/2 (spread $\pm 1.5\%$ or off)	Y	N
CY22800-021A	Spread spectrum for consumer and communication applications	CLKIN: 25.0–100.0 XTAL: 25.0–30.1	CLKA: REF (spread $\pm 1.75\%$ or off) CLKB: REF or REF/2 (spread $\pm 1.75\%$ or off)	Y	N
CY22800-022A	Spread spectrum for consumer and communication applications	CLKIN: 25.0–100.0 XTAL: 25.0–30.0	CLKA: REF (spread $\pm 2.0\%$ or off) CLKB: REF or REF/2 (spread $\pm 2.0\%$ or off)	Y	N
CY22800-023A	MPEG-2 clock generator for DTV and STB w/ VCXO	XTAL: 13.5	CLKA: 27 CLKB: 54 CLKC: 27	N	Y
CY22800-024A	MPEG-2 clock generator for DTV and STB w/ VCXO	XTAL: 13.5	CLKA: 13.5 CLKB: 54 CLKC: 27	N	Y
CY22800-025A	MPEG-2 clock generator for DTV and STB w/ VCXO	XTAL: 13.5/27.0 (Selectable)	CLKB: 27, 27	N	Y
CY22800-026A	MPEG-2 clock generator for DTV and STB w/ VCXO	XTAL: 13.5/27.0 (Selectable)	CLKB: 27, 27 CLKC: 27, 27	N	Y
CY22800-027A	MPEG-2 clock generator for DTV and STB w/ VCXO	XTAL: 27	CLKB: 27, 27 CLKC: 27, 27.027 (–1 ppm)	N	Y
CY22800-028A	MPEG-2 clock generator for DTV and STB w/ VCXO	XTAL: 27	CLKB: 27, 27 CLKC: 27, 27.027 (0 ppm)	N	Y
CY22800-029A	HDTV, STB clock generator (USB/Ethernet/iLink clock)	XTAL/CLKIN: 27	CLKA: 24.576, 25, 20, 48 CLKB: 27	N	N
CY22800-030A	HDTV, STB clock generator (Ethernet/PCI/Microprocessor clock)	XTAL/CLKIN: 27	CLKA: 25, 20 CLKB: 27 CLKC: 33.33, 66.66	N	N
CY22800-031A	HDTV, STB clock generator (PCI/Microprocessor clock)	XTAL/CLKIN: 48	CLKA: 33.33, 66.66, 100, 133.33 CLKB: 48	N	N
CY22800-032A	HDTV, STB clock generator (pixel clocks)	XTAL/CLKIN: 27	CLKA: 74.25, 74.175824, 148.5, 148.351648 CLKB: 27	N	N
CY22800-033A	Audio clock generator for HDTV & STB (256fs)	XTAL/CLKIN: 27	CLKA: (32K, 44.1K, 48K) $\times$ 256 CLKB: 27	N	N

**CY22800 Configurations** *(continued)*

Code #	Code name	Input Freq. (MHz)	Output Freq. (MHz)	SS	VCXO
CY22800-034A	Audio clock generator for HDTV & STB (384fs)	XTAL/CLKIN: 27	CLKA: (32K, 44.1K, 48K) x 384 CLKB: 27	N	N
CY22800-035A	Audio clock generator for HDTV & STB (512fs)	XTAL/CLKIN: 27	CLKA: (32K, 44.1K, 48K) x 512 CLKB: 27	N	N
CY22800-036A	Audio clock generator for HDTV & STB (768fs)	XTAL/CLKIN: 27	CLKA: (32K, 44.1K, 48K) x 768 CLKB: 27	N	N
CY22800-037A	Spread spectrum clock generator for PCI and ASIC	XTAL/CLKIN: 14.31818	CLKA: 33.33, 66.66, 100, 133.33 (-0.5% or off)	Y	N
CY22800-038A	Spread spectrum clock generator for PCI and ASIC	XTAL/CLKIN: 14.31818	CLKA: 33.33, 66.66, 100, 133.33 (-1.0% or off)	Y	N
CY22800-039A	Spread spectrum clock generator for PCI and ASIC	XTAL/CLKIN: 14.31818	CLKA: 33.33, 66.66, 100, 133.33 (±0.25% or off)	Y	N
CY22800-040A	Spread spectrum clock generator for PCI and ASIC	XTAL/CLKIN: 14.31818	CLKA: 33.33, 66.66, 100, 133.33 (±0.5% or off)	Y	N
CY22800-041A	Spread spectrum clock generator for Audio / Video Applications	XTAL/CLKIN: 27	CLKA: 33, 66 (spread -0.5% or off) CLKB: 27	Y	N
CY22800-042A	Spread spectrum clock generator for Audio / Video Applications	XTAL/CLKIN: 27	CLKA: 33, 66 (spread -1.0% or off) CLKB: 27	Y	N
CY22800-043A	Spread spectrum clock generator for Audio / Video Applications	XTAL/CLKIN: 27	CLKA: 33, 66 (spread ±0.25% or off) CLKB: 27	Y	N
CY22800-044A	Spread spectrum clock generator for Audio / Video Applications	XTAL/CLKIN: 27	CLKA: 33, 66 (spread ±0.5% or off) CLKB: 27	Y	N
CY22800-045A	Spread spectrum clock generator with Multiplier option	CLKIN: 35-100	CLKA: x1, x2, x4 or /2 (spread -0.5%) CLKB: REFOUT	Y	N
CY22800-046A	Spread spectrum clock generator with Multiplier option	CLKIN: 35-100	CLKA: x1, x2, x4 or /2 (spread -1.0%) CLKB: REFOUT	Y	N
CY22800-047A	Spread spectrum clock generator with Multiplier option	CLKIN: 35-100	CLKA: x1, x2, x4 or /2 (spread -1.5%) CLKB: REFOUT	Y	N
CY22800-048A	Spread spectrum clock generator with Multiplier option	CLKIN: 35-100	CLKA: x1, x2, x4 or /2 (spread -2.0%) CLKB: REFOUT	Y	N
CY22800-049A	Spread spectrum clock generator with Multiplier option	CLKIN: 35-100	CLKA: x1, x2, x4 or /2 (spread -2.5%) CLKB: REFOUT	Y	N
CY22800-050A	Spread spectrum clock generator for PCI and ASIC	XTAL/CLKIN: 14.31818	CLKA: 33.33, 66.66, 100, 133.33 (-1.5% or off)	Y	N
CY22800-051A	x10 Multiplier	CLKIN: 0.5-20 XTAL: 8-20	CLKA: 5-200 CLKB: REFOUT	N	N
CY22800-052A	x12 Multiplier	CLKIN: 0.5-16.66 XTAL: 8-16.66	CLKA: 6-200.0 CLKB: REFOUT	N	N
CY22800-053A	x15 Multiplier	CLKIN: 0.5-13.33 XTAL: 8-13.33	CLKA: 7.5-200 CLKB: REFOUT	N	N
CY22800-054A	x20 Multiplier	CLKIN: 0.5-10 XTAL: 8-10	CLKA: 10-200 CLKB: REFOUT	N	N
CY22800-055A	x25 Multiplier	CLKIN: 0.5-8 XTAL: 8	CLKA: 12.5-200 CLKB: REFOUT	N	N

**CY22800 Configurations** *(continued)*

Code #	Code name	Input Freq. (MHz)	Output Freq. (MHz)	SS	VCXO
CY22800-056A	2/3 Multiplier	CLKIN: 2.5–133 XTAL: 8–30	CLKA: 1.67–88.67 CLKB: REFOUT	N	N
CY22800-057A	4/3 Multiplier	CLKIN: 2–100 XTAL: 8–30	CLKA: 2.66–133.33 CLKB: REFOUT	N	N
CY22800-058A	3/4 Multiplier	CLKIN: 3.5–133 XTAL: 8–30	CLKA: 2.625–99.75 CLKB: REFOUT	N	N
CY22800-059A	3/2 Multiplier	CLKIN: 1.5–133 XTAL: 8–30	CLKA: 2.25–199.5 CLKB: REFOUT	N	N
CY22800-060A	2/5 Multiplier	CLKIN: 5–133 XTAL: 8–30	CLKA: 2–53.2 CLKB: REFOUT	N	N
CY22800-061A	3/5 Multiplier	CLKIN: 3.5–133 XTAL: 8–30	CLKA: 2.1–80 CLKB: REFOUT	N	N
CY22800-062A	5/6 Multiplier	CLKIN: 3–80 XTAL: 8–30	CLKA: 2.5–66.67 CLKB: REFOUT	N	N
CY22800-063A	6/5 Multiplier	CLKIN: 2–66.67 XTAL: 8–30	CLKA: 2.4–80 CLKB: REFOUT	N	N
CY22800-064A	5/8 Multiplier	CLKIN: 2.5–80 XTAL: 8–30	CLKA: 1.56–50 CLKB: REFOUT	N	N
CY22800-065A	8/5 Multiplier	CLKIN: 2–50 XTAL: 8–30	CLKA: 3.2–80 CLKB: REFOUT	N	N
CY22800-066A	Spread spectrum clock generator for Audio / Video Applications	XTAL/CLKIN: 27	CLKA: 33, 66 (spread –1.5% or off) CLKB: 27	Y	N
CY22800-067A	5/4 Multiplier	CLKIN: 5–133 XTAL: 8–30	CLKA: 6–166 CLKB: REFOUT	N	N
CY22800-068A	4/5 Multiplier	CLKIN: 5–33 XTAL: 8–30	CLKA: 4–106 CLKB: REFOUT	N	N
CY22800-069A	66/64 Multiplier	CLKIN: 5–133 XTAL: 8–30	CLKA: 5–137 CLKB: REFOUT	N	N
CY22800-070A	64/66 Multiplier	CLKIN: 5–133 XTAL: 8–30	CLKA: 5–129 CLKB: REFOUT	N	N
CY22800-071A	255/238 Multiplier	CLKIN: 5–133 XTAL: 8–30	CLKA: 5–142 CLKB: REFOUT	N	N
CY22800-072A	238/255 Multiplier	CLKIN: 5–133 XTAL: 8–30	CLKA: 5–124 CLKB: REFOUT	N	N
CY22800-073A	3-Output Fanout Buffer	CLKIN: 1–133 XTAL: 8–30	CLKA = CLKB = CLKC: REFOUT	N	N
CY22800-074A	X2 Multiplier with Fanout and REFOUT	CLKIN: 9–100 XTAL: 9–30	CLKA = CLKC: 18–200 CLKB: REFOUT	N	N
CY22800-075A	X3 Multiplier with Fanout and REFOUT	CLKIN: 6–66 XTAL: 8–30	CLKA = CLKC: 18–200 CLKB: REFOUT	N	N
CY22800-076A	X4 Multiplier with Fanout and REFOUT	CLKIN: 5–50 XTAL: 8–30	CLKA = CLKC: 20–200 CLKB: REFOUT	N	N
CY22800-077A	/2 Clock Divider	CLKIN: 0.5–133 XTAL: 8–30	CLKA: 0.25–66.5 CLKB = CLKC: 0.25–66.5 or off	N	N
CY22800-078A	/3 Clock Divider	CLKIN: 0.5–133 XTAL: 8–30	CLKA: 0.17–44.3 CLKB = CLKC: 0.17–44.3 or off	N	N
CY22800-079A	/4 Clock Divider	CLKIN: 0.5–133 XTAL: 8–30	CLKA: 0.125–33.25 CLKB = CLKC: 0.125–33.25 or off	N	N
CY22800-080A	/5 Clock Divider	CLKIN: 0.5–133 XTAL: 8–30	CLKA: 0.1–26.6 CLKB = CLKC: 0.1–26.6 or off	N	N



**CY22800 Configurations** *(continued)*

Code #	Code name	Input Freq. (MHz)	Output Freq. (MHz)	SS	VCXO
CY22800-081A	/6 Clock Divider	CLKIN: 0.5–133 XTAL: 8–30	CLKA: 0.083–22.2 CLKB = CLKC: 0.083–22.2 or off	N	N
CY22800-082A	/7 Clock Divider	CLKIN: 0.5–133 XTAL: 8–30	CLKA: 0.071–19 CLKB = CLKC: 0.071–19 or off	N	N
CY22800-083A	/8 Clock Divider	CLKIN: 0.5–133 XTAL: 8–30	CLKA: 0.063–16.6 CLKB = CLKC: 0.063–v16.6 or off	N	N
CY22800-084A	/9 Clock Divider	CLKIN: 0.5–133 XTAL: 8–30	CLKA: 0.056–14.8 CLKB = CLKC: 0.056–14.8 or off	N	N
CY22800-085A	/10 Clock Divider	CLKIN: 0.5–133 XTAL: 8–30	CLKA: 0.05–13.3 CLKB = CLKC: 0.05–13.3 or off	N	N
<b>Industrial Temperature Range</b>					
CY22800-115A	Spread spectrum for consumer and communication applications	CLKIN: 25– 82.5 XTAL: 25–30	CLKA: REF (spread $\pm 0.25\%$ or off) CLKB: REF or REF/2 (spread $\pm 0.25\%$ or off)	Y	N
CY22800-116A	Spread spectrum for consumer and communication applications	CLKIN: 25–82.5 XTAL: 25–30	CLKA: REF (spread $\pm 0.5\%$ or off) CLKB: REF or REF/2 (spread $\pm 0.5\%$ or off)	Y	N
CY22800-117A	Spread spectrum for consumer and communication applications	CLKIN: 25–82.5 XTAL: 25 - 30	CLKA: REF (spread $\pm 0.75\%$ or off) CLKB: REF or REF/2 (spread $\pm 0.75\%$ or off)	Y	N
CY22800-118A	Spread spectrum for consumer and communication applications	CLKIN: 25–82.5 XTAL: 25–30	CLKA: REF (spread $\pm 1.0\%$ or off) CLKB: REF or REF/2 (spread $\pm 1.0\%$ or off)	Y	N
CY22800-119A	Spread spectrum for consumer and communication applications	CLKIN: 25–82.5 XTAL: 25–30	CLKA: REF (spread $\pm 1.25\%$ or off) CLKB: REF or REF/2 (spread $\pm 1.25\%$ or off)	Y	N
CY22800-120A	Spread spectrum for consumer and communication applications	CLKIN: 25–82.5 XTAL: 25–30	CLKA: REF (spread $\pm 1.5\%$ or off) CLKB: REF or REF/2 (spread $\pm 1.5\%$ or off)	Y	N
CY22800-121A	Spread spectrum for consumer and communication applications	CLKIN: 25–82.5 XTAL: 25–30	CLKA: REF (spread $\pm 1.75\%$ or off) CLKB: REF or REF/2 (spread $\pm 1.75\%$ or off)	Y	N
CY22800-145A	Spread spectrum clock generator with Multiplier option	CLKIN: 35–82.5	CLKA: $\times 1, \times 2, \times 4$ or /2 (spread $-0.5\%$ ) CLKB: REFOUT	Y	N
CY22800-146A	Spread spectrum clock generator with Multiplier option	CLKIN: 35–82.5	CLKA: $\times 1, \times 2, \times 4$ or /2 (spread $-1.0\%$ ) CLKB: REFOUT	Y	N
CY22800-147A	Spread spectrum clock generator with Multiplier option	CLKIN: 35–82.5	CLKA: $\times 1, \times 2, \times 4$ or /2 (spread $-1.5\%$ ) CLKB: REFOUT	Y	N
CY22800-148A	Spread spectrum clock generator with Multiplier option	CLKIN: 35–82.5	CLKA: $\times 1, \times 2, \times 4$ or /2 (spread $-2.0\%$ ) CLKB: REFOUT	Y	N
CY22800-151A	$\times 10$ Multiplier	CLKIN: 0.5–16.5 XTAL: 8–16.5	CLKA: 5–165 CLKB: REFOUT	N	N
CY22800-152A	$\times 12$ Multiplier	CLKIN: 0.5–13.75 XTAL: 8–13.75	CLKA: 6–165 CLKB: REFOUT	N	N
CY22800-153A	$\times 15$ Multiplier	CLKIN: 0.5–11 XTAL: 8–11	CLKA: 7.5–165 CLKB: REFOUT	N	N

**CY22800 Configurations** (continued)

Code #	Code name	Input Freq. (MHz)	Output Freq. (MHz)	SS	VCXO
CY22800-154A	x20 Multiplier	CLKIN: 0.5–8.25 XTAL: 8–8.25	CLKA: 10–165 CLKB: REFOUT	N	N
CY22800-155A	x25 Multiplier	CLKIN: 0.5–6.6 XTAL: 8–6.6	CLKA: 12.5–165 CLKB: REFOUT	N	N
CY22800-156A	2/3 Multiplier	CLKIN: 2.5–82.5 XTAL: 8–30	CLKA: 1.67–55 CLKB: REFOUT	N	N
CY22800-157A	4/3 Multiplier	CLKIN: 1.5–82.5 XTAL: 8–27.5	CLKA: 2–110 CLKB: REFOUT	N	N
CY22800-158A	3/4 Multiplier	CLKIN: 3.5–110 XTAL: 8–30	CLKA: 2.625–82.5 CLKB: REFOUT	N	N
CY22800-159A	3/2 Multiplier	CLKIN: 1.5–110 XTAL: 8–27.5	CLKA: 2.25–165 CLKB: REFOUT	N	N
CY22800-160A	2/5 Multiplier	CLKIN: 5–133 XTAL: 8–30	CLKA: 2–53.2 CLKB: REFOUT	N	N
CY22800-161A	3/5 Multiplier	CLKIN: 3.5–110 XTAL: 8–30	CLKA: 2.1–66 CLKB: REFOUT	N	N
CY22800-162A	5/6 Multiplier	CLKIN: 3–66 XTAL: 8–30	CLKA: 2.5–55 CLKB: REFOUT	N	N
CY22800-163A	6/5 Multiplier	CLKIN: 2–55 XTAL: 8–30	CLKA: 2.4–66 CLKB: REFOUT	N	N
CY22800-164A	5/8 Multiplier	CLKIN: 2.5–80 XTAL: 8–30	CLKA: 1.56–50 CLKB: REFOUT	N	N
CY22800-165A	8/5 Multiplier	CLKIN: 2–41.25 XTAL: 8–30	CLKA: 3.2–66 CLKB: REFOUT	N	N

Cypress offers a wide range of programmable clock synthesizers that can be used to generate any other frequencies not covered by the CY22800. [Cypress Programmable Clocks](#) summarizes all Cypress programmable devices including CY22800.

**Cypress Programmable Clocks**

Part # <sup>[3]</sup>	No. of PLL	Input Freq.	Output Freq.	Package	No. of Outputs	Spread Spectrum	VCXO	I <sup>2</sup> C
CY22800	1	0.5–100	up to 200	8-pin SOIC	up to 3	Yes	Yes	No
CY22801	1	0.5–133	up to 200	8-pin SOIC	up to 3	No	No	No
CY22050	1	1–133	0.08–200	16-pin TSSOP	up to 6	No	No	No
CY22150	1	1–133	0.08–200	16-pin TSSOP	up to 6	No	No	Yes
CY25100	1	8–166	3–200	8-pin SOIC / 8-pin TSSOP	up to 2	Yes	No	No
CY25200	1	3–166	3–200	16-pin TSSOP	up to 6	Yes	No	No
CY241V08	1	27/13.5	27/13.5	8-pin SOIC	up to 2	No	Yes	No
CY22392	3	1–166	up to 200	16-pin TSSOP	up to 6	No	No	No
CY22381	3	1–166	up to 200	8-pin SOIC	up to 3	No	No	No
CY22393	3	1–166	up to 200	16-pin TSSOP	up to 6	No	No	Yes
CY22394/5	3	1–166	up to 200	16-pin TSSOP	up to 5	No	No	No
CY22388/89/91	4	1–100	1–166	16-pin TSSOP / 20-pin TSSOP, 32-pin QFN	up to 8	No	Yes	No

**Note**

3. CY3672 can be used to program the clock devices listed in [Cypress Programmable Clocks](#).

### Absolute Maximum Conditions

Parameter	Description	Min	Max	Unit
V <sub>DD</sub>	Supply voltage	-0.5	4.6	V
T <sub>S</sub>	Storage temperature	-65	125	°C
T <sub>J</sub>	Junction temperature	-	125	°C
	Digital inputs	V <sub>SS</sub> - 0.3	V <sub>DD</sub> + 0.3	V
	Digital outputs referred to V <sub>DD</sub>	V <sub>SS</sub> - 0.3	V <sub>DD</sub> + 0.3	V
	Electro-static discharge	2	-	kV

### Recommended Operating Conditions

Parameter	Description	Min	Typ	Max	Unit
V <sub>DD</sub>	Operating voltage	3.14	3.3	3.47	V
T <sub>A</sub>	Ambient temperature, commercial grade	0	-	70	°C
	Ambient temperature, industrial grade	-40	-	85	°C
C <sub>LOAD</sub>	Max. load capacitance on the CLK output	-	-	15	pF
f <sub>REF</sub> <sup>[4]</sup>	Reference frequency	0.5	-	100	MHz
t <sub>PU</sub>	Power up time for all V <sub>DDs</sub> to reach minimum specified voltage (power ramps must be monotonic)	0.05	-	500	ms

### Pullable Crystal Specifications for VCXO Application Only

Parameter	Name	Min	Typ	Max	Unit
C <sub>LNOM</sub>	Crystal load capacitance	-	14	-	pF
R <sub>1</sub>	Equivalent series resistance	-	-	25	Ω
R <sub>3</sub> /R <sub>1</sub>	Ratio of third overtone mode ESR to Fundamental Mode ESR. Ratio used because typical R <sub>1</sub> values are much less than the maximum spec	3	-	-	-
DL	Crystal drive level. No external series resistor assumed	-	0.5	2	mW
F <sub>3SEPHI</sub>	Third overtone separation from 3 × F <sub>NOM</sub> (High Side)	300	-	-	ppm
F <sub>3SEPLO</sub>	Third overtone separation from 3 × F <sub>NOM</sub> (Low Side)	-	-	-150	ppm
C <sub>0</sub>	Crystal shunt capacitance	-	-	7	pF
C <sub>0</sub> /C <sub>1</sub>	Ratio of Shunt to motional capacitance	180	-	250	
C <sub>1</sub>	Crystal motional capacitance	14.4	18	21.6	fF

**Note**

4. Configuration dependent, see the one-page documents.

**Recommended Crystal Specifications for All other Applications**

Parameter	Name	Description	Min	Typ	Max	Unit
F <sub>NOM</sub>	Nominal crystal frequency	Parallel resonance, fundamental mode, and AT cut	8	–	30	MHz
C <sub>LNOM</sub>	Nominal load capacitance		–	12	–	pF
R <sub>1</sub>	Equivalent series resistance (ESR)	Fundamental mode	–	35	50	Ω
DL	Crystal drive level	No external series resistor assumed	–	0.5	2	mW

**DC Electrical Specifications**

Parameter	Name	Description	Min	Typ	Max	Unit
I <sub>OH</sub>	Output high current	V <sub>OH</sub> = V <sub>DD</sub> – 0.5 V, V <sub>DD</sub> = 3.3 V (source)	12	24	–	mA
I <sub>OL</sub>	Output low current	V <sub>OL</sub> = 0.5 V, V <sub>DD</sub> = 3.3 V (sink)	12	24	–	mA
C <sub>IN1</sub>	Input capacitance	All input pins except XIN and XOUT	–	–	7	pF
C <sub>IN2</sub>	Input capacitance	XIN and XOUT pins for non-VCXO applications	–	24	–	pF
I <sub>IH</sub>	Input high current	V <sub>IH</sub> = V <sub>DD</sub>	–	5	10	μA
I <sub>IL</sub>	Input low current	V <sub>IL</sub> = 0 V	–	–	50	μA
f <sub>ΔXO</sub>	VCXO pullability range		±150	–	–	ppm
V <sub>VCXO</sub>	VCXO input range		0	–	V <sub>DD</sub>	V
V <sub>IH</sub>	Input high voltage	CMOS levels, 70% of V <sub>DD</sub>	0.7	–	–	V <sub>DD</sub>
V <sub>IL</sub>	Input low voltage	CMOS levels, 30% of V <sub>DD</sub>	–	–	0.3	V <sub>DD</sub>

**AC Electrical Characteristics (V<sub>DD</sub> = 3.3 V)**

Parameter	Name	Description	Min	Typ	Max	Unit
DC	Output duty cycle	Duty cycle is defined in <a href="#">Figure 4</a> , 50% of V <sub>DD</sub>	45	50	55	%
t <sub>3</sub>	Rising edge slew rate	Output clock rise time, 20%–80% of V <sub>DD</sub>	0.8	1.4	–	V/ns
t <sub>4</sub>	Falling edge slew rate	Output clock fall time, 80%–20% of V <sub>DD</sub>	0.8	1.4	–	V/ns
t <sub>10</sub>	PLL Lock Time		–	–	3	ms

## Test Circuit

**Figure 3. Test Circuit Diagram**

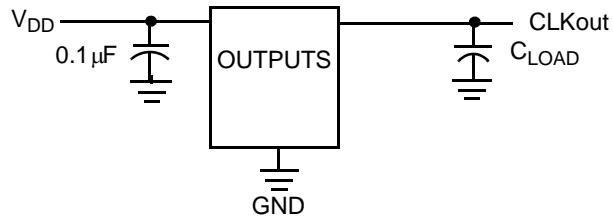

## Timing Definitions

**Figure 4. Duty Cycle Definition;  $DC = t2/t1$**

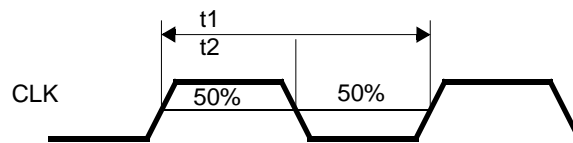

**Figure 5. Rise and Fall Time Definitions**

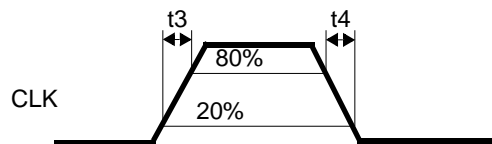

**Ordering Information**

Ordering Code	Package Type	Operating Range	Operating Voltage
CY22800KFXC	8-pin SOIC	Commercial	3.3 V
CY22800KFXCT	8-pin SOIC – Tape and Reel	Commercial	3.3 V
CY22800KFXI	8-pin SOIC	Industrial	3.3 V
CY22800KFXIT	8-pin SOIC – Tape and Reel	Industrial	3.3 V

**Ordering Code Definitions**

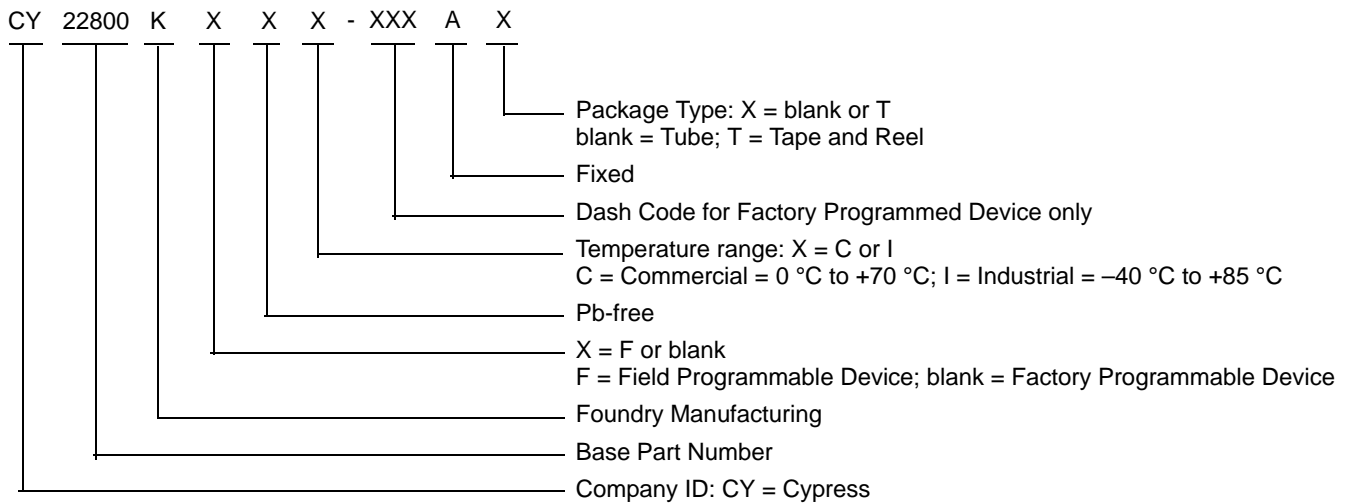

Package Diagram

Figure 6. 8-pin SOIC (150 Mils) S08.15/SZ08.15 Package Outline, 51-85066

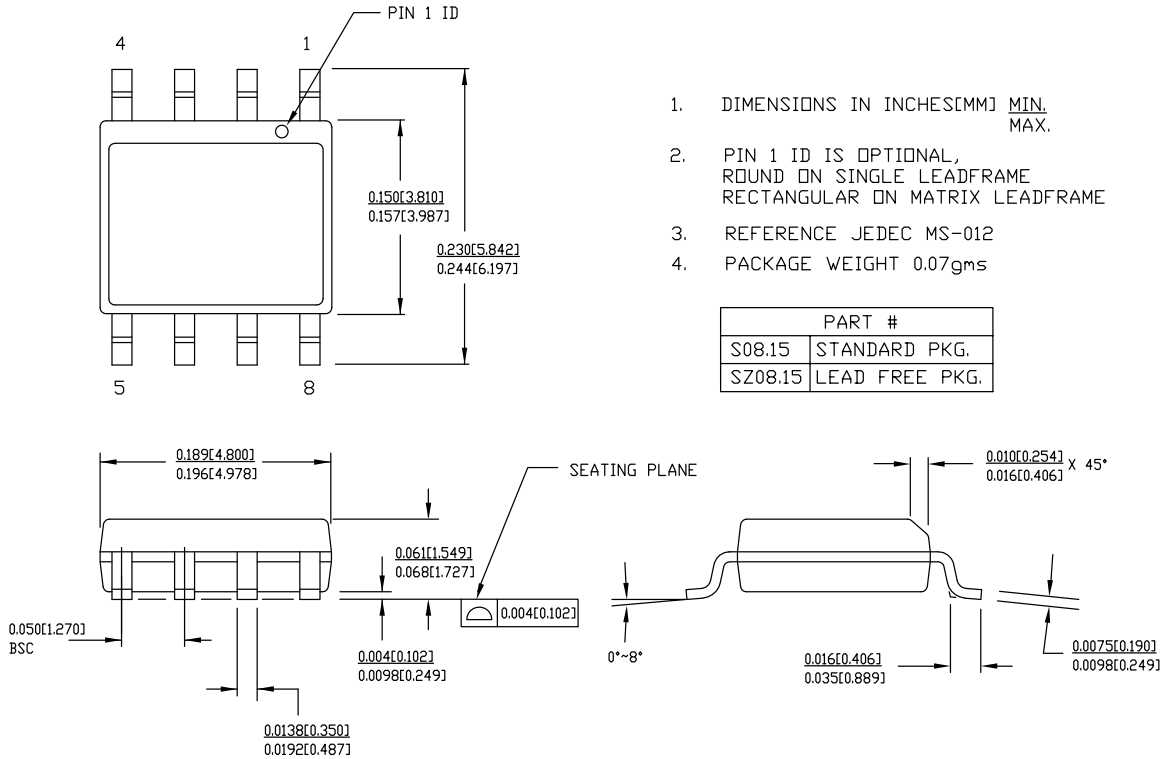

PART #	
S08.15	STANDARD PKG.
SZ08.15	LEAD FREE PKG.

51-85066 \*F

## Acronyms

**Table 1. Acronyms used in this Document**

Acronym	Description
ASIC	application-specific integrated circuit
CMOS	complementary metal oxide semiconductor
DTV	digital television
EMC	electromagnetic compatibility
EMI	electromagnetic interference
ESR	equivalent series resistance
HDTV	high-definition television
PCI	peripheral component interface
PLL	phase-locked loop
QFN	quad flat no-lead
SOIC	small outline integrated circuit
SSC	supervisory system call
SSCG	spread spectrum clock generator
STB	set-top box
TSSOP	thin-shrink small outline package
UPCG	universal programmable clock generator
VCXO	voltage controlled crystal oscillator

## Document Conventions

### Units of Measure

**Table 2. Units of Measure**

Symbol	Unit of Measure
°C	degree Celsius
fF	femtofarad
kV	kilovolt
MHz	megahertz
μA	microampere
μF	microfarad
mA	milliampere
ms	millisecond
mW	milliwatt
ns	nanosecond
Ω	ohm
ppm	parts per million
%	percent
pF	picofarad
V	volt



Document History Page

Document Title: CY22800, Universal Programmable Clock Generator (UPCG) Document Number: 001-07704				
Rev.	ECN No.	Orig. of Change	Submission Date	Description of Change
**	478688	KKVTMP	07/10/2006	New data sheet
*A	1063800	KKVTMP	05/20/2007	Updated <a href="#">Features</a> (Added Industrial Temperature information). Updated <a href="#">Functional Description</a> (Updated the sentence to read as “The CY22800 is a reprogrammable device that can be programmed up to 100 times.”). Updated <a href="#">CY22800 Configurations</a> (Added Industrial Temperature information and also some more codes and their respective details). Updated <a href="#">Cypress Programmable Clocks</a> (Added CY22801 and its details). Updated <a href="#">Recommended Operating Conditions</a> (Added Industrial Temperature information). Updated <a href="#">Pullable Crystal Specifications for VCXO Application ONLY</a> (Changed unit for C <sub>1</sub> parameter from pF to fF). Updated <a href="#">Ordering Information</a> (Added Industrial Temperature information).
*B	2440628	AESA	05/25/2008	Updated Note 3. Added part numbers CY22800FXCT, CY22800FXIT, CY22800KFXC, CY22800KFXCT, CY22800KFXI, and CY22800KFXIT in <a href="#">Ordering Information</a> . Added Note “Not recommended for new designs.” below <a href="#">Ordering Information</a> . Updated template.
*C	2897294	KVM	03/22/2010	Removed part numbers CY22800FXC, CY22800FXCT, CY22800FXI and CY22800FXIT from the <a href="#">Ordering Information</a> . Removed Note “Not recommended for new designs.” below <a href="#">Ordering Information</a> . Updated <a href="#">Package Diagram</a> . Updated copyright section.
*D	3349379	PURU	08/26/2011	Removed Benefits section on page 1. Updated <a href="#">Package Diagram</a> . Added <a href="#">Ordering Code Definitions</a> . Added <a href="#">Acronyms</a> and <a href="#">Units of Measure</a> .
*E	3471796	PURU	12/21/2011	Replaced all instances of CYTRA-102004-00 with CY22800 across the document.
*F	4491759	XHT	9/8/2014	Sunset review, updated package revision
*G	4576237	XHT	11/21/2014	Added related documentation hyperlink in page 1. Updated the Output Frequency for the following parts in <a href="#">Cypress Programmable Clocks</a> table: CY22800, CY22801, CY22392, CY22381, CY22393, CY22394/5, and CY22388/89/91.

## Sales, Solutions, and Legal Information

### Worldwide Sales and Design Support

Cypress maintains a worldwide network of offices, solution centers, manufacturer's representatives, and distributors. To find the office closest to you, visit us at [Cypress Locations](#).

### Products

<a href="#">Automotive</a>	<a href="http://cypress.com/go/automotive">cypress.com/go/automotive</a>
<a href="#">Clocks &amp; Buffers</a>	<a href="http://cypress.com/go/clocks">cypress.com/go/clocks</a>
<a href="#">Interface</a>	<a href="http://cypress.com/go/interface">cypress.com/go/interface</a>
<a href="#">Lighting &amp; Power Control</a>	<a href="http://cypress.com/go/powerpsoc">cypress.com/go/powerpsoc</a> <a href="http://cypress.com/go/plc">cypress.com/go/plc</a>
<a href="#">Memory</a>	<a href="http://cypress.com/go/memory">cypress.com/go/memory</a>
<a href="#">Optical &amp; Image Sensing</a>	<a href="http://cypress.com/go/image">cypress.com/go/image</a>
<a href="#">PSoC</a>	<a href="http://cypress.com/go/psoc">cypress.com/go/psoc</a>
<a href="#">Touch Sensing</a>	<a href="http://cypress.com/go/touch">cypress.com/go/touch</a>
<a href="#">USB Controllers</a>	<a href="http://cypress.com/go/USB">cypress.com/go/USB</a>
<a href="#">Wireless/RF</a>	<a href="http://cypress.com/go/wireless">cypress.com/go/wireless</a>

### PSoC Solutions

[psoc.cypress.com/solutions](http://psoc.cypress.com/solutions)  
PSoC 1 | PSoC 3 | PSoC 5

---

© Cypress Semiconductor Corporation, 2006-2014. The information contained herein is subject to change without notice. Cypress Semiconductor Corporation assumes no responsibility for the use of any circuitry other than circuitry embodied in a Cypress product. Nor does it convey or imply any license under patent or other rights. Cypress products are not warranted nor intended to be used for medical, life support, life saving, critical control or safety applications, unless pursuant to an express written agreement with Cypress. Furthermore, Cypress does not authorize its products for use as critical components in life-support systems where a malfunction or failure may reasonably be expected to result in significant injury to the user. The inclusion of Cypress products in life-support systems application implies that the manufacturer assumes all risk of such use and in doing so indemnifies Cypress against all charges.

Any Source Code (software and/or firmware) is owned by Cypress Semiconductor Corporation (Cypress) and is protected by and subject to worldwide patent protection (United States and foreign), United States copyright laws and international treaty provisions. Cypress hereby grants to licensee a personal, non-exclusive, non-transferable license to copy, use, modify, create derivative works of, and compile the Cypress Source Code and derivative works for the sole purpose of creating custom software and or firmware in support of licensee product to be used only in conjunction with a Cypress integrated circuit as specified in the applicable agreement. Any reproduction, modification, translation, compilation, or representation of this Source Code except as specified above is prohibited without the express written permission of Cypress.

Disclaimer: CYPRESS MAKES NO WARRANTY OF ANY KIND, EXPRESS OR IMPLIED, WITH REGARD TO THIS MATERIAL, INCLUDING, BUT NOT LIMITED TO, THE IMPLIED WARRANTIES OF MERCHANTABILITY AND FITNESS FOR A PARTICULAR PURPOSE. Cypress reserves the right to make changes without further notice to the materials described herein. Cypress does not assume any liability arising out of the application or use of any product or circuit described herein. Cypress does not authorize its products for use as critical components in life-support systems where a malfunction or failure may reasonably be expected to result in significant injury to the user. The inclusion of Cypress' product in a life-support systems application implies that the manufacturer assumes all risk of such use and in doing so indemnifies Cypress against all charges.

Use may be limited by and subject to the applicable Cypress software license agreement.

## Данный компонент на территории Российской Федерации

### Вы можете приобрести в компании MosChip.

Для оперативного оформления запроса Вам необходимо перейти по данной ссылке:

<http://moschip.ru/get-element>

Вы можете разместить у нас заказ для любого Вашего проекта, будь то серийное производство или разработка единичного прибора.

В нашем ассортименте представлены ведущие мировые производители активных и пассивных электронных компонентов.

Нашей специализацией является поставка электронной компонентной базы двойного назначения, продукции таких производителей как XILINX, Intel (ex.ALTERA), Vicor, Microchip, Texas Instruments, Analog Devices, Mini-Circuits, Amphenol, Glenair.

Сотрудничество с глобальными дистрибьюторами электронных компонентов, предоставляет возможность заказывать и получать с международных складов практически любой перечень компонентов в оптимальные для Вас сроки.

На всех этапах разработки и производства наши партнеры могут получить квалифицированную поддержку опытных инженеров.

Система менеджмента качества компании отвечает требованиям в соответствии с ГОСТ Р ИСО 9001, ГОСТ РВ 0015-002 и ЭС РД 009

### Офис по работе с юридическими лицами:

105318, г.Москва, ул.Щербаковская д.3, офис 1107, 1118, ДЦ «Щербаковский»

Телефон: +7 495 668-12-70 (многоканальный)

Факс: +7 495 668-12-70 (доб.304)

E-mail: [info@moschip.ru](mailto:info@moschip.ru)

Skype отдела продаж:

moschip.ru

moschip.ru\_4

moschip.ru\_6

moschip.ru\_9