

## INTRODUCTIONS

1. Direct PC board mounting for easy installation and space saving.
2. ME2: UL.

ME3D:  
 ME3:  
 ME3G:  
 ME3B:  
 ME3DA/GA:  
 15ME2/ME3:  
 02ME4E2:  
 ME4/P: UL, CSA, TUV

UL, CSA, VDE,

## COMPONENTS

PART NO.	C1 (uF)	L1 (mH)	PART NO.	C1 (uF)	L1 (mH)
01ME2	0.1	3.7	03ME3G-R/(S)	0.1	2.5
01ME3/(S)	0.033	5	03ME4/P	0.47	15
02ME3G/(S)	0.1	7	06ME2	0.1	0.4
02ME3GA/(S)			06ME3/(S)	0.033	0.6
02ME3G-R/(S)	0.47	25	06ME3D/(S)	0.047	0.53
02ME4E1			06ME3DA/(S)		
*02ME4E2	0.22	25	06ME3G/(S)	0.1	0.8
*02MP1		20	06ME3GA/(S)		
*02MP2		25	06ME3G-R(S)		
03ME2	0.1	1.3	10ME2	0.1	0.1
03ME2A	0.1	2.5	10ME3/(S)	0.033	0.18
03ME3/(S)	0.033	2.3	10ME3G/(S)	0.1	0.2
03ME3G/(S)	0.1	2.5	10ME3		
*03ME3GA/(S)			** 15ME2	0.1	0.12
*03ME3B			** 15ME3/(S)		
03ME3DA/(S)	0.047	1.2			
03ME3D/(S)					

- \* UL, CSA approved to 2.5A 115/250VAC
- 03ME3D/(S): 03ME3D, 03ME3D(S)
- VDE, SEV, SEMKO approved to 10A/250VAC

## MINIMUM INSERTION LOSS IN dB

COMMON MODE (L-G) IN 50 OHM SYSTEM															
TYPE	CURRENT RATING	FREQUENCY-MHz						TYPE	CURRENT RATING	FREQUENCY-MHz					
		.15	.50	1.0	5.0	10	30			.15	50	1.0	5.0	10	30
01ME2	1A	27	37	42	44	45	35	03ME3G	3A	20	25	30	38	40	40
01ME3/(S)	1A	25	35	40	40	40	40	03ME3GA	3A	20	23	30	40	40	40
02ME3G/(S)	2A	28	35	28	38	40	40	06ME2	6A	12	18	20	35	40	50
02ME3GA/(S)	2A	20	25	35	40	40	40	06ME3	6A	12	20	25	40	45	45
02ME4E1	2A	35	45	45	35	35	35	06ME3D	6A	10	20	20	30	35	40
02ME4E2	2.5/2A	30	40	40	35	35	40	06ME3DA	6A	8	10	15	30	30	40
02ME4/P	2A	35	45	45	35	35	35	06ME3G	6A	10	15	20	35	40	40
02MP1	2.5/2A	45	60	60	45	40	25	06ME3GA	6A	10	15	20	30	35	40
02MP2	2.5/2A	50	55	55	50	40	25	10ME3/(S)	10A	4	10	15	30	38	45
03ME2	3A	15	28	32	45	45	50	10ME3G/(S)	10A	4	10	13	28	35	40
03ME3	3A	22	30	35	45	45	48	15ME2	15A/10A	2	8	10	20	25	40
03ME3B	3A	12	20	28	40	40	40	15ME3/(S)	15A/10A	2	8	10	20	25	40
03ME3D	3A	18	28	39	48	48	55								
03ME3DA	3A	15	25	30	40	40	45								
03ME4/P	3A	30	40	40	35	35	35								

## SPECIFICATIONS

1. Maximum leakage current each  
 line-to-ground @ 115VAC 60Hz: 0.20mA  
 0.45mA (02ME4E1)  
 @ 250VAC 50Hz: 0.40mA  
 0.80mA (02ME4E1)
2. Hipot rating (one minute)  
 line-to-ground: 2250VDC  
 line-to-line: 1450VDC
3. Operating frequency: 50/60Hz
4. Rated voltage: 115/250VAC

## ELECTRICAL SCHEMATIC

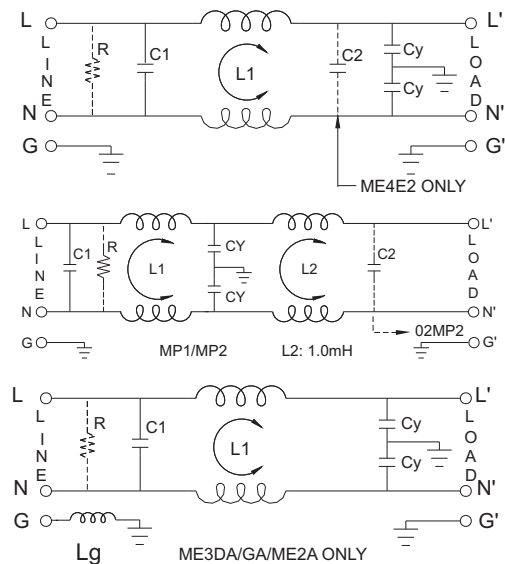

- R: 1MΩ(ME3)      C2: 0.1μF(ME4E2/MP2)
- R: 560KΩ(ME4)    R: 330KΩ(ME4E2)
- Cy: 2200pF
- Cy: 4700pF(ME4/E1)
- Lg: 18.3μH (2A/GA/DA)

### INSERTION LOSS (TYPICAL)

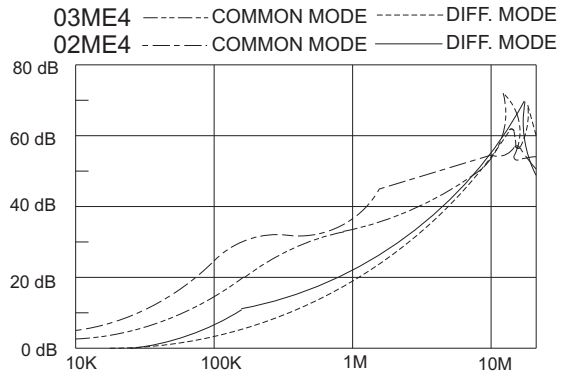
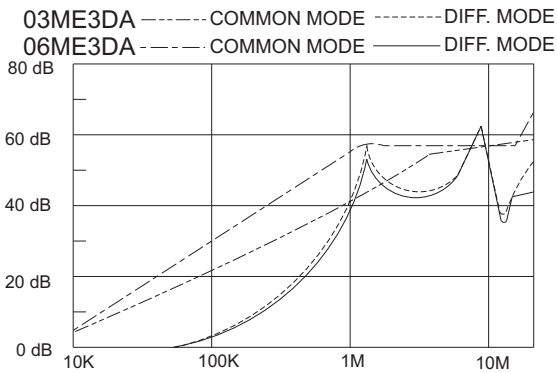
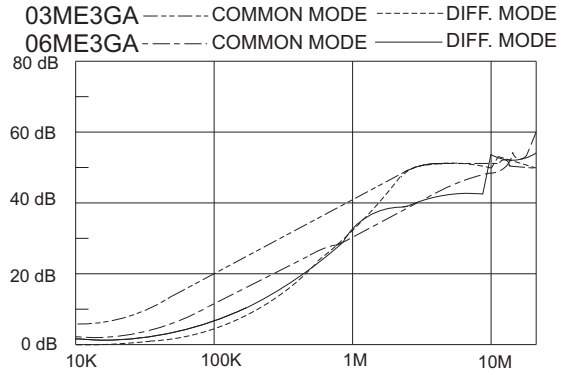
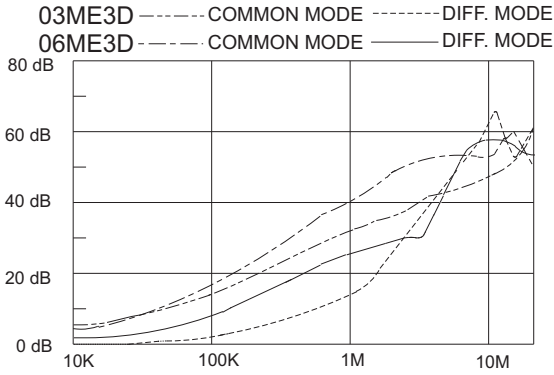
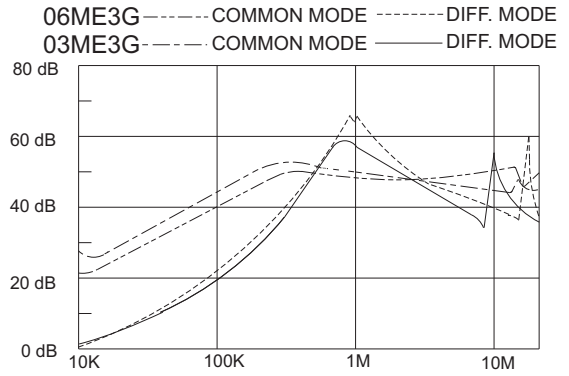
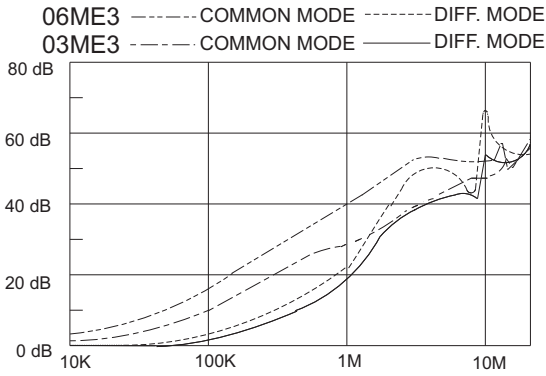

### MECHANICAL CONSTRUCTION



ME2/ME2A

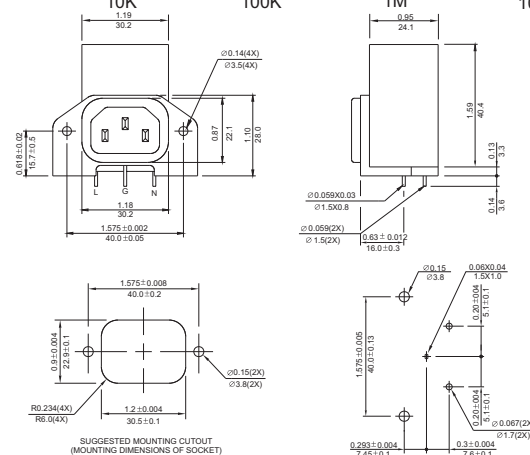

UNIT: INCH  
mm



◆ **Proposal of installation for ME3 series please follow these steps to install:**

1. Insert filter to PCB and soldering.
2. Screw panel and filter on PCB.
3. Assemble case with PCB with panel and filter.

Note: - Socket of filter should be assembled with mounting hole of case tightly for easy insertion of power cord.  
 - Screw from the outside of case to fix filter for more secured assembly (optional).



ME3

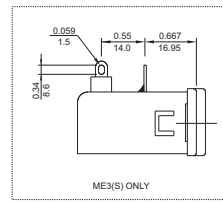

ME3DA

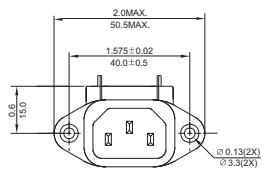
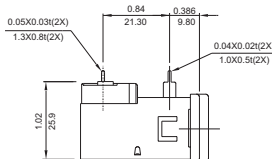
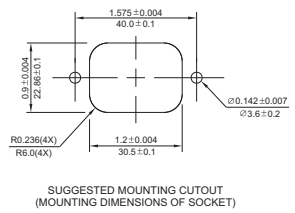

ME4E

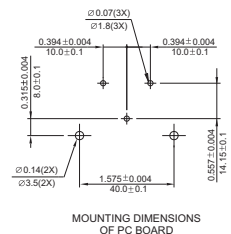
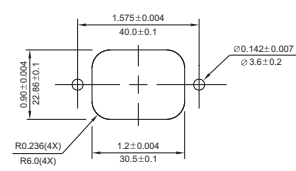
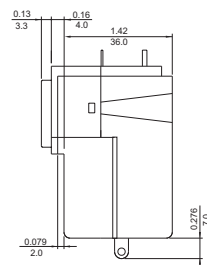
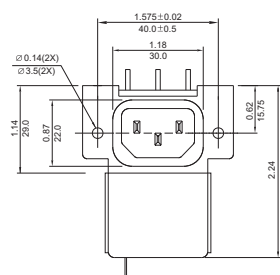

SUGGESTED MOUNTING CUTOUT (MOUNTING DIMENSIONS OF SOCKET)

MOUNTING DIMENSIONS OF PC BOARD

UNIT: INCH  
mm

IEC INLET PC BOARD MOUNTING FILTERS

## Данный компонент на территории Российской Федерации

### Вы можете приобрести в компании MosChip.

Для оперативного оформления запроса Вам необходимо перейти по данной ссылке:

<http://moschip.ru/get-element>

Вы можете разместить у нас заказ для любого Вашего проекта, будь то серийное производство или разработка единичного прибора.

В нашем ассортименте представлены ведущие мировые производители активных и пассивных электронных компонентов.

Нашей специализацией является поставка электронной компонентной базы двойного назначения, продукции таких производителей как XILINX, Intel (ex.ALTERA), Vicor, Microchip, Texas Instruments, Analog Devices, Mini-Circuits, Amphenol, Glenair.

Сотрудничество с глобальными дистрибьюторами электронных компонентов, предоставляет возможность заказывать и получать с международных складов практически любой перечень компонентов в оптимальные для Вас сроки.

На всех этапах разработки и производства наши партнеры могут получить квалифицированную поддержку опытных инженеров.

Система менеджмента качества компании отвечает требованиям в соответствии с ГОСТ Р ИСО 9001, ГОСТ РВ 0015-002 и ЭС РД 009

### Офис по работе с юридическими лицами:

105318, г.Москва, ул.Щербаковская д.3, офис 1107, 1118, ДЦ «Щербаковский»

Телефон: +7 495 668-12-70 (многоканальный)

Факс: +7 495 668-12-70 (доб.304)

E-mail: [info@moschip.ru](mailto:info@moschip.ru)

Skype отдела продаж:

moschip.ru

moschip.ru\_4

moschip.ru\_6

moschip.ru\_9