

Safety Interlock Switches

MC-S Series



Rev. 9.10

Compact Coded Magnetic Safety Interlock Switch and Control Unit

- Dual channel, fully monitored system; meets Category 3 when single MC-S Series switch and control unit are used; MC-S6 meets Category 4
- External Device Monitoring (EDM) with automatic or manual reset
- NEMA 6 switch enclosures in plastic or stainless steel with connector satisfy most application requirements
- Magnetically coded switches are tamper resistant to common magnets
- Misalignment tolerance of (5 and 9 mm) reduces nuisance tripping
- A large number of switches may be used with a MC-S Series control unit
- MC-S6 control unit provides individual monitoring and indication for up to 6 switches and a N/O delayed output
- Mechanical interlock switches may be used with a MC-S Series control
- MC-S Series controls may replace a safety relay in some applications
- Auxiliary contacts available for individual guard door monitoring on MC-S switches



Conforms to EN954-1, EN1088, EN60204-1 UL and C-UL listed

G

Actual Size

Type 1 Sensor

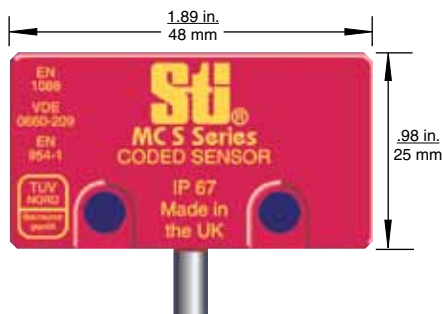

Type 2 Sensor

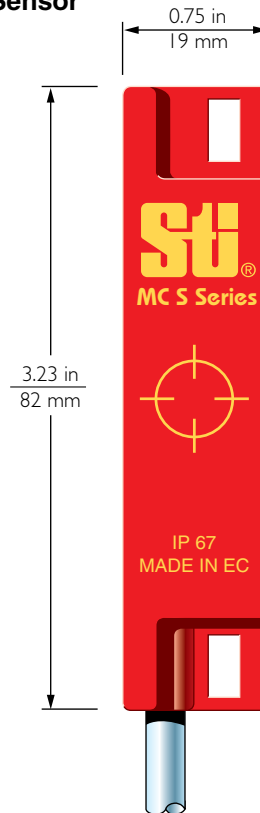

Description

The MC-S Series is a tamper resistant non-contact switch that operates with its own control unit. As a fully monitored dual channel system, a single MC-S Series switch and MC-S Series Control Units 1 or 2 combine to fulfill Category 3 requirements. Control Unit 6 with 2 to 6 MC-S switches fulfills Category 4 requirements for the 3 N/O outputs and Category 3 for the N/O delayed output.

The Control Units provide EDM (External Device Monitoring, also called MPCE monitoring) with an automatic or manual reset. This allows the Control Units to replace a safety relay in some applications.

The NEMA 6 encapsulated design makes it ideal for harsh environments.

The Control Units can be used with a large number of MC-S switches for applications with multiple guard doors. The Control Unit provides individual monitoring and LED indication for up to six MC-S switches. Mechanical switches and MC-S switches may be used together with a single MC-S Control Unit for applications requiring both non-contact and mechanical safety interlock switches.

Operation

Operating Principle

On presenting the actuator to the switch, the coded, high intensity magnetic field from the actuator causes the contacts to close. On removing the actuator (opening the door), the safety contacts open, isolating the machine.

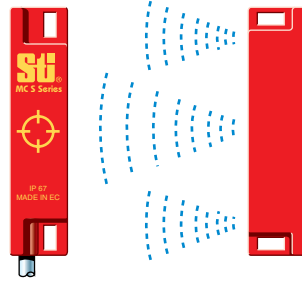

Mounting Examples

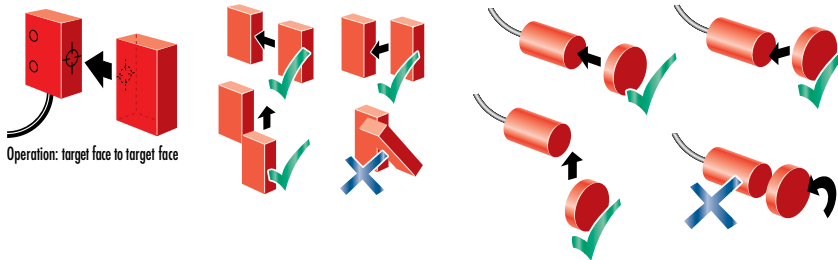

G

Contact Arrangements

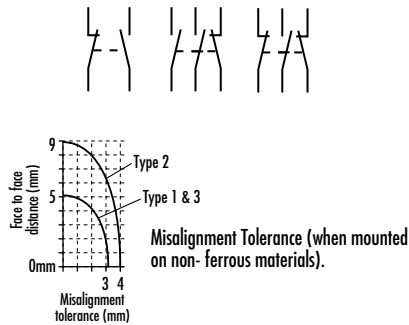

NOTE: ACTUATOR MUST NOT STRIKE SENSOR

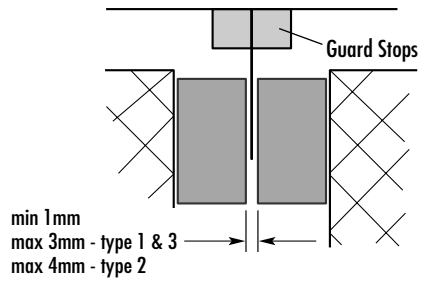

Connector Configurations

MC-SS2 Stainless Steel

8-Pin Male, Micro DC, M12 SWITCH

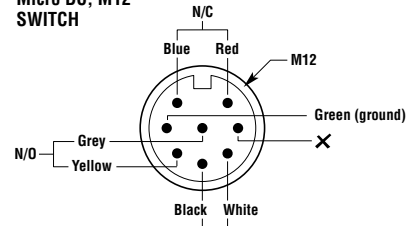

Auxiliary Circuit - not for safety use (N/O or N/C)

8-Pin Female, Micro DC, M12 INCLUDED CABLE

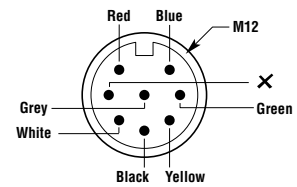

8-Pin Female, Micro DC, M12 ACCESSORY CABLE 44512-0620

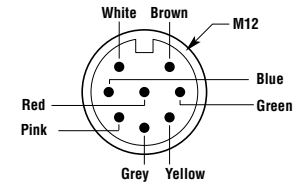

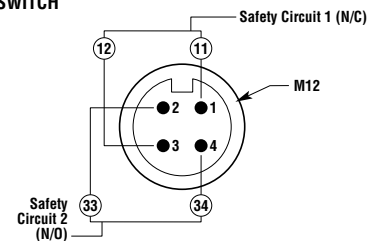

MC-S3

4-Pin Male, Micro DC, M12 SWITCH

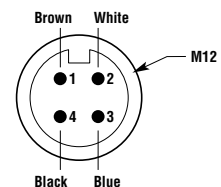

4-Pin Female, Micro DC, M12 ACCESSORY CABLE 44512-0600



 Universal Mounting Brackets can be used with this product. See accessories on www.sti.com

Applications

Typical applications are on sliding guard doors or swinging guard doors.

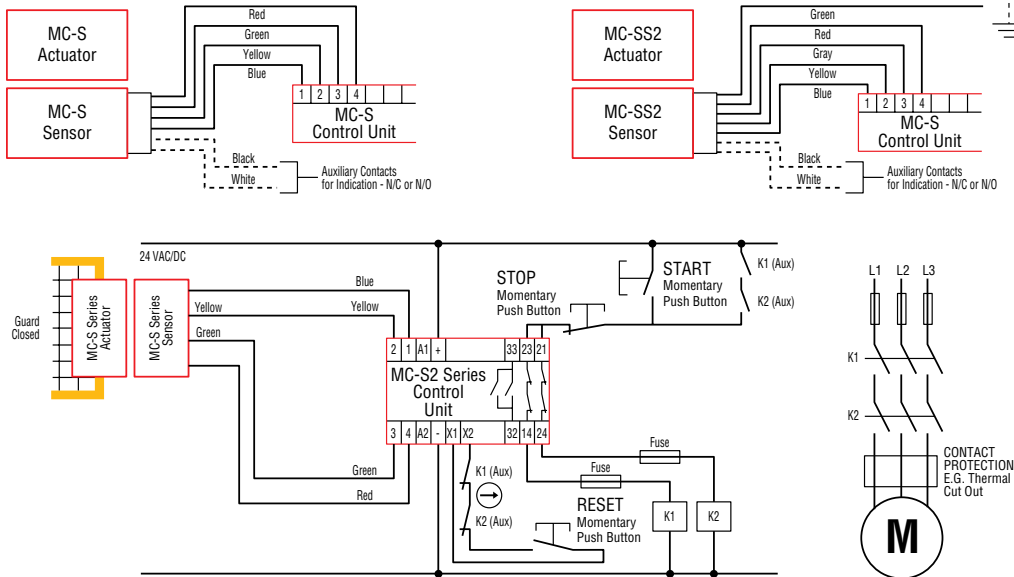
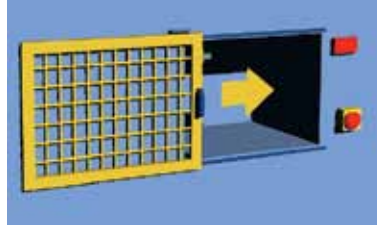

Single sensor and two contactors with manual reset and EDM (External Device Monitoring). Machine will start when guard is closed, auxiliary contacts at K1 and K2 are closed (i.e. both contactors are off), reset button is pressed and then start button is pressed.

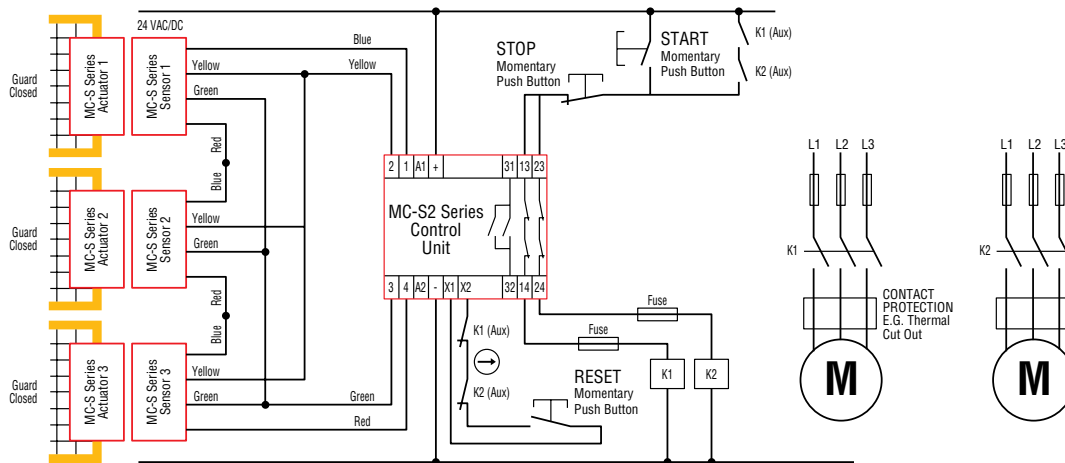

Three sensors and two contactors with manual reset and EDM (External Device Monitoring). Machine will start when all guards are closed, reset button is pressed and then start button is pressed. NOTE: The use of multiple sensors connected to a single control unit is only suitable in applications where each guard door is always opened and then shut individually. Otherwise some single faults may not be detected and unintentional lockout reset may occur if two or more guard doors are open at the same time.

Specifications

Electrical	MC-S Series Control Units	MC-S Series Switches
Power Supply:	24 VAC/DC \pm 10% - Control 1 24 VDC \pm 10% or 24/110/220 VAC - Control 2 & 6	—
Power Consumption:	< 2 VA Control 1; < 4 VA - Control 2 & 6	—
Safety Inputs:	1 N/O + 1 N/C for controls 1 & 2 (x6 for Control 6)	—
Max Input Resistance:	Red/Blue - 200 Ω ; Green/Yellow - 150 Ω	—
Min. Approach Speed:	Typically 10-17 mm/sec.	
Safety Contacts:	—	1 N/C + 1 N/O
Auxiliary Contacts:	—	1 N/C or 1 N/O
Auxiliary Contact Rating:	—	100 mA, 24 VDC and 230 VAC
Relay Outputs:	1 N/O + 1 Semi Aux. - Control 1 2 N/O + 1 N/C Aux. - Control 2	Control 6 Delayed Output (0.6-30 s) 3 N/O + 1 N/O Delayed, 1 N/C Aux. - Control 6
Auxiliary Contact of Controls:	100 mA, 24 VDC and 230 VAC - Control 1 2 A, 24 VDC and 230 VAC - Control 2 and 6	—
N/C Operating Distance:	—	On = 5 mm; Off = 11 mm Type 1 and Type 3 On = 9 mm; Off = 12 mm Type 2 On = 10 mm; Off = 13 mm Type 2 stainless
Max Switched AC:	4 A/250 VAC	100 mA/230 VAC
Max Switched DC:	2 A/30 VDC	100 mA/24 VDC
Min Switched Current/Voltage:	10 mA/10 V AC/DC	—
Impulse Withstand Voltage:	2500 V	—
Max Drop-Out Time:	25 m/sec	—
Max Output Fuse:	5 A quick acting on AC, 3 A quick acting on DC (3 A quick acting on AC/DC Control 6)	—
Reset Mode:	Automatic/Manual	—
External Device Monitoring:	N/C loop between x1 and x2	—
Mechanical		
Mounting:	35 mm (1.38 in.) DIN Rail	4 x M4 screws, M18 x 1 mm pitch for MC-S3
Case Material:	Polycarbonate	ABS plastic - Type 1 & 2; nylon - Type 3; stainless steel - Type 2 stainless
Max Wire Size:	2 x 1 mm (20 AWG) stranded 2 x 1.5 mm (15 AWG) solid	Pre-wired cable to 10 m MC-S1, S2, Connector MC-SS2, MC-S3
Weight:	147 g (5.2 oz.) - Control 1, 590 g (21 oz.) - Control 2, 990 g (35 oz.) - Control 6	100 g (3.5 oz.) plastic, 600 g (1-lb. 5-oz.) steel
Color:	Red	Red or Stainless steel
Indication:	LED 1: Green = Output Closed LED 2: Red = Power On Controls 1 & 2 LED 2: Green = Power on Control 6	— —
Mechanical Life:	1 x 10 ⁶	1 x 10 ⁶
Environmental		
Protection:	IP40 (NEMA 1)	IP67 (NEMA 6); (IP68 for stainless)
Operating Temperature:	-10 to 55°C (14 to 131°F)	-10 to 55°C (14 to 131°F) Plastic -25 to 125°C (-13 to 257°F) Stainless
Humidity:	90% RH at 50°C (122°F)	90% RH at 50°C (122°F)
Compliance		
Standards:	EN954-1, EN1088, EN60204-1	
Approvals/Listings:	CE marked for all applicable directives, UL and C-UL	

Specifications are subject to change without notice.

Note: The safety contacts of the Omron STI switches are described as normally closed (N/C) i.e., with the guard closed, actuator in place, and the machine able to be started.

Dimensions

(mm/in.)

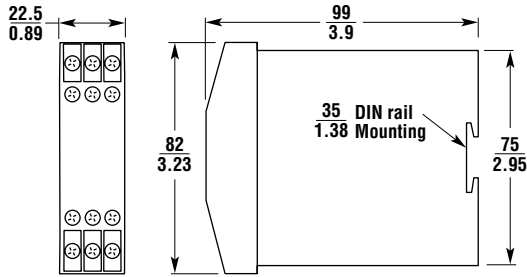

Control Unit 1

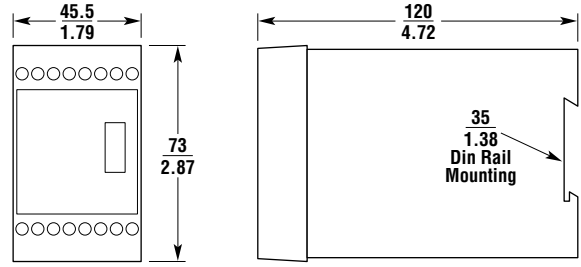

Control Unit 2

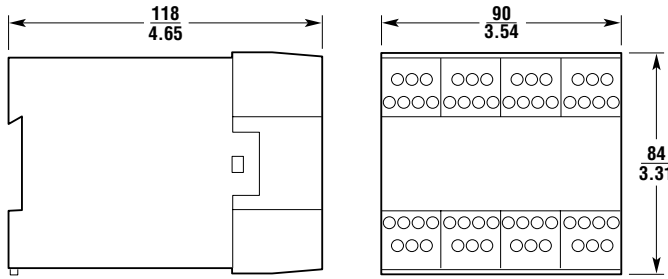

Control Unit 6

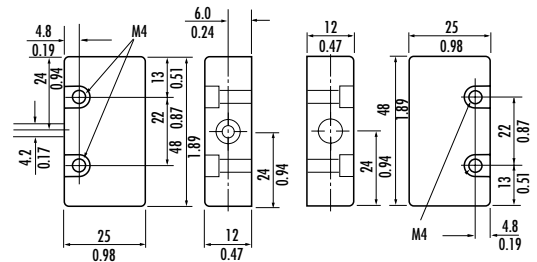

Switch - Type 1

Actuator - Type 1

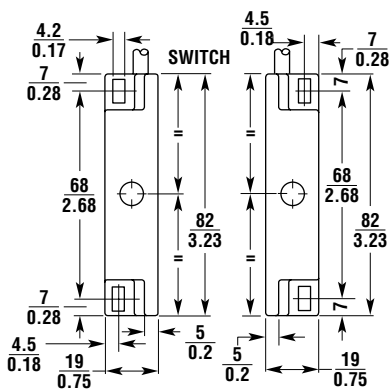

Switch - Type 2

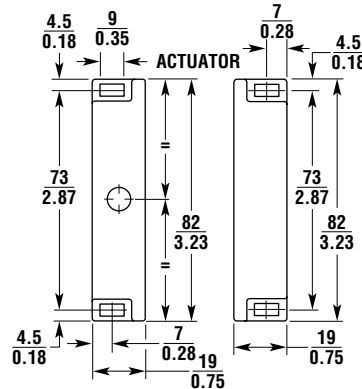

Actuator - Type 2

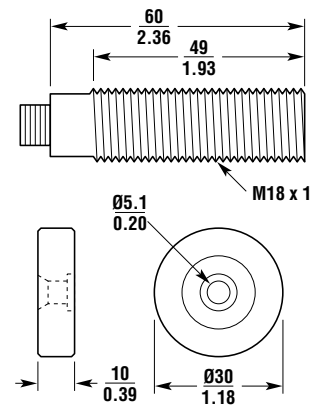

Switch - Type 3

Actuator - Type 3

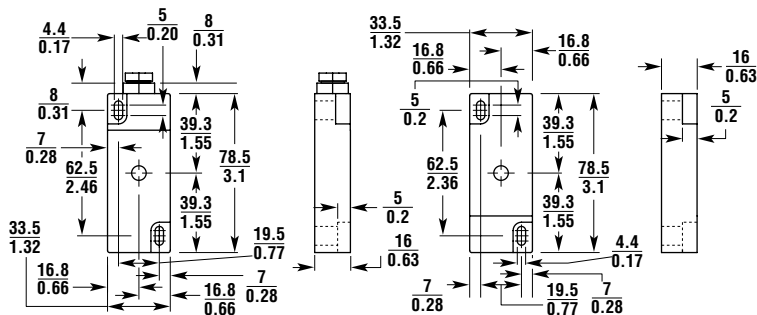

Switch - Type 2
Stainless steel

Actuator - Type 2
Stainless steel

Ordering

Model	Contacts	Wiring Entry	Part No.
CONTROL UNITS			
Unit 1			
MC-S1 Control (24VAC/DC) (1 switch input)	1 N/O + 1 N/C Semi Aux.		44531-0010
Unit 2			
MC-S2 Control (24VAC/DC + 110/220VAC) (1 switch input)	2 N/O + 1 N/C Aux.		44531-0020
Unit 6			
MC-S6 Control (24VAC/DC + 110/220VAC) (6 switch inputs)	3 N/O + 1 N/O Delayed, 1 N/C Aux.		44531-0040
PLASTIC CASE SWITCHES			
Type 1			
MC-S1PC3 Switch & Actuator	1 N/C + 1 N/O	3 m cable	44531-0100
MC-S1PC10 Switch & Actuator	1 N/C + 1 N/O	10 m cable	44531-0110
MC-S1XCPC3 Switch & Actuator w/ signal contacts	2 N/C + 1 N/O (N/C Aux. Contact)	3 m cable	44531-0150
MC-S1XOPC3 Switch & Actuator w/ signal contacts	1 N/C + 2 N/O (N/O Aux. Contact)	3 m cable	44531-0155
MC-S1XCPC10 Switch & Actuator w/ signal contacts	2 N/C + 1 N/O (N/C Aux. Contact)	10 m cable	44531-0160
MC-S1XOPC10 Switch & Actuator w/signal contacts	1 N/C + 2 N/O (N/O Aux. Contact)	10 m cable	44531-0165
Type 2			
MC-S2PC3 Switch & Actuator	1 N/C + 1 N/O	3 m cable	44531-0200
MC-S2PC10 Switch & Actuator	1 N/C + 1 N/O	10 m cable	44531-0210
MC-S2XCPC3 Switch & Actuator w/ signal contacts	2 N/C + 1 N/O (N/C Aux. Contact)	3 m cable	44531-0250
MC-S2XOPC3 Switch & Actuator w/signal contacts	1 N/C + 2 N/O (N/O Aux. Contact)	3 m cable	44531-0255
MC-S2XCPC10 Switch & Actuator w/signal contacts	2 N/C + 1 N/O (N/C Aux. Contact)	10 m cable	44531-0260
MC-S2XOPC10	1 N/C + 2 N/O (N/O Aux. Contact)	10 m cable	44531-0265
Type 3			
MC-S3PCC Switch & Actuator	1 N/C + 1 N/O	connector	44531-0300
STAINLESS STEEL CASE SWITCHES			
MC-SS2XOSCC5	1 N/C + 2 N/O (N/O Aux. Contact)	connector + 5 m cable	44531-0450
MC-SS2XCSCC5	2 N/C + 1 N/O (N/C Aux. Contact)	connector + 5 m cable	44531-0455
MC-SS2X0SC6	1 N/C + 2 N/O (N/O Aux. Contact)	6 m cable	44531-0460
MC-SS2XCSC6	2 N/C + 1 N/O (N/C Aux. Contact)	6 m cable	44531-0465
Spare MC-S Type 1 Actuator, Plastic			44531-0710
Spare MC-S Type 2 Actuator, Plastic			44531-0720
Spare MC-S Type 3 Actuator, Plastic			44531-0730
Spare MC-SS2 Actuator, Stainless Steel			44531-0740



Universal Mounting Brackets
can be used with this product.
See accessories on www.sti.com

Данный компонент на территории Российской Федерации

Вы можете приобрести в компании MosChip.

Для оперативного оформления запроса Вам необходимо перейти по данной ссылке:

<http://moschip.ru/get-element>

Вы можете разместить у нас заказ для любого Вашего проекта, будь то серийное производство или разработка единичного прибора.

В нашем ассортименте представлены ведущие мировые производители активных и пассивных электронных компонентов.

Нашей специализацией является поставка электронной компонентной базы двойного назначения, продукции таких производителей как XILINX, Intel (ex.ALTERA), Vicor, Microchip, Texas Instruments, Analog Devices, Mini-Circuits, Amphenol, Glenair.

Сотрудничество с глобальными дистрибьюторами электронных компонентов, предоставляет возможность заказывать и получать с международных складов практически любой перечень компонентов в оптимальные для Вас сроки.

На всех этапах разработки и производства наши партнеры могут получить квалифицированную поддержку опытных инженеров.

Система менеджмента качества компании отвечает требованиям в соответствии с ГОСТ Р ИСО 9001, ГОСТ РВ 0015-002 и ЭС РД 009

Офис по работе с юридическими лицами:

105318, г.Москва, ул.Щербаковская д.3, офис 1107, 1118, ДЦ «Щербаковский»

Телефон: +7 495 668-12-70 (многоканальный)

Факс: +7 495 668-12-70 (доб.304)

E-mail: info@moschip.ru

Skype отдела продаж:

moschip.ru

moschip.ru_4

moschip.ru_6

moschip.ru_9