

# Surface Mount 1575.42MHz SAW Filter

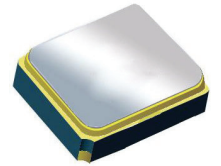

1.4 x 1.1 x 0.7 mm

**AFS14A04-1575.42-T3**

Moisture Sensitivity Level (MSL) – This product is Hermetically Sealed and not Moisture Sensitive - MSL = N/A: Not Applicable



**RoHS**  
Compliant

## FEATURES:

- 1.4 x 1.1 x 0.7 mm low profile SMT package
- Low Insertion loss
- Excellent selectivity with high out-of-band rejection

## APPLICATIONS:

- Wireless Communication
- Remote Control
- Cellular Phones

## ELECTRICAL SPECIFICATIONS:

### Maximum Ratings

Item	Value
Input Power Level	+15 dBm max.
DC Permissive Voltage	3.0V DC max.
Operating Temperature Range	-40°C to + 85°C
Storage Temperature Range	-40°C to + 85°C

Parameters	Minimum	Typical	Maximum	Units	Notes
Center Frequency ( $f_c$ )		1575.42		MHz	
Insertion Loss (IL)		0.90	1.50	dB	(1574.42~1576.42 MHz)
Effective Bandwidth		40		MHz	
Amplitude Ripple		0.1	0.75	dB	(1574.42~1576.42 MHz)
Worst-Case Input / Output Return Loss		23	12.7	dB	(1574.42~1576.42 MHz)
Stop-band Attenuation (Referenced to 0.0 dB)	35	38		dB	D.C~1450 MHz
	30	45			1450~1520 MHz
	45	48			1625~1640 MHz
	38	40			1640~1805 MHz
	38	40			1805~1910 MHz
	38	43			1910~2000 MHz
	30	45			2000~4000 MHz
	20	22			4000~6000 MHz
Source Impedance ( $Z_S$ )		50		$\Omega$	See note # 1
Load Impedance ( $Z_L$ )		50		$\Omega$	See note # 1

**Note #1:** No matching network required for operation into 50 $\Omega$ 's

## TEST CIRCUIT:

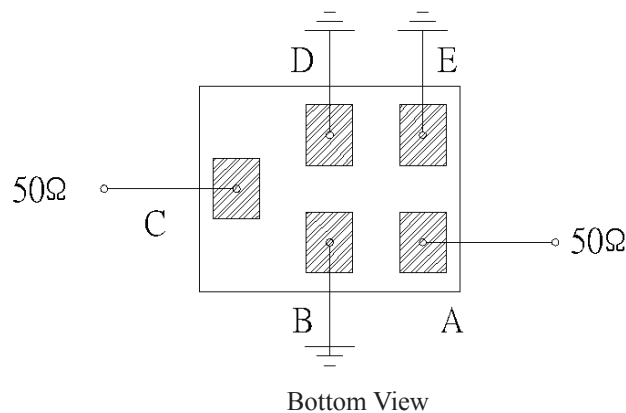

# Surface Mount 1575.42MHz SAW Filter

AFS14A04-1575.42-T3



RoHS  
Compliant

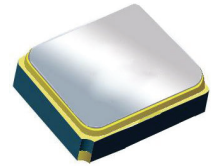

1.4 x 1.1 x 0.7 mm

## OUTLINE DIMENSIONS:

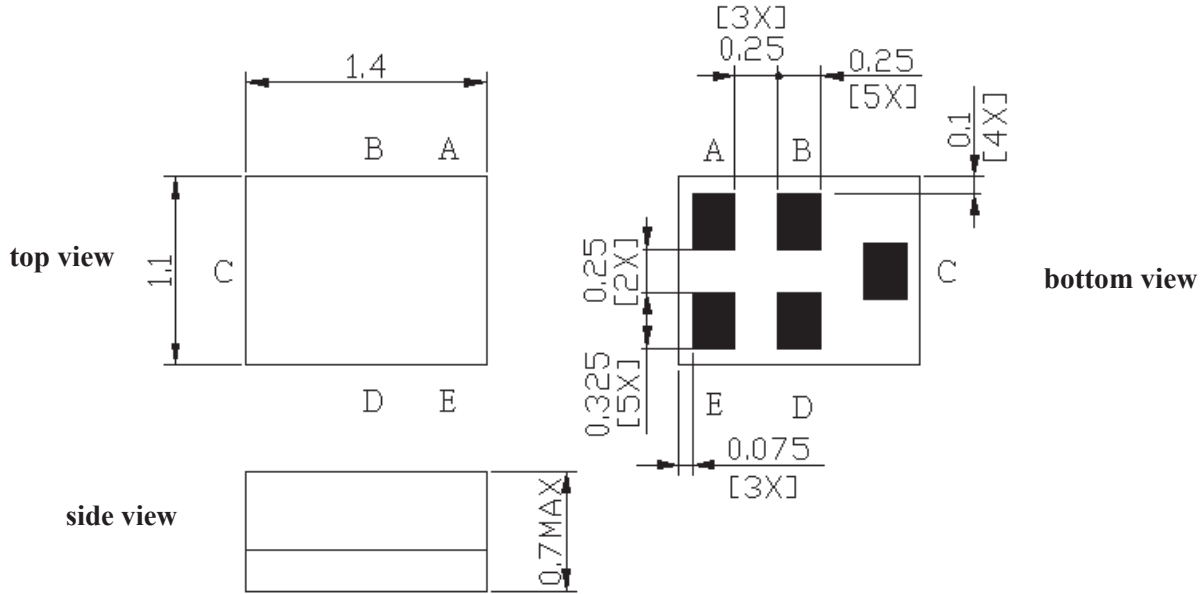

<b>C:</b>	Input
<b>A:</b>	Output
<b>B, D, E:</b>	Ground

### Recommended Land Pattern:

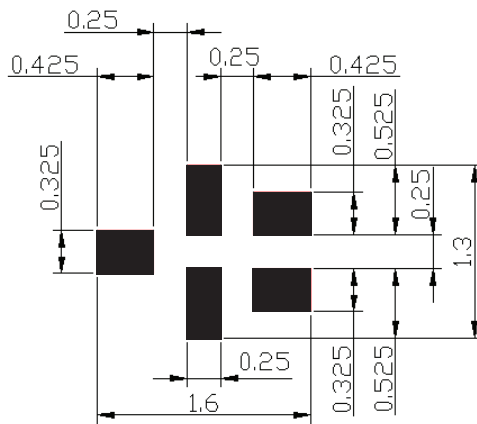

■ : Land Pattern  
Unit : mm

\*All Dimensions are in mm

# Surface Mount 1575.42MHz SAW Filter

AFS14A04-1575.42-T3



**RoHS**  
Compliant



1.4 x 1.1 x 0.7 mm

## FREQUENCY CHARACTERISTICS:

Filter Frequency Response (*Narrowband*)

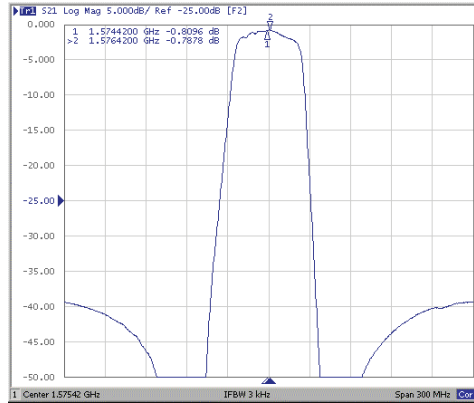

Filter Frequency Response (*Wideband*)



## REFLECTION FUNCTIONS:

S11

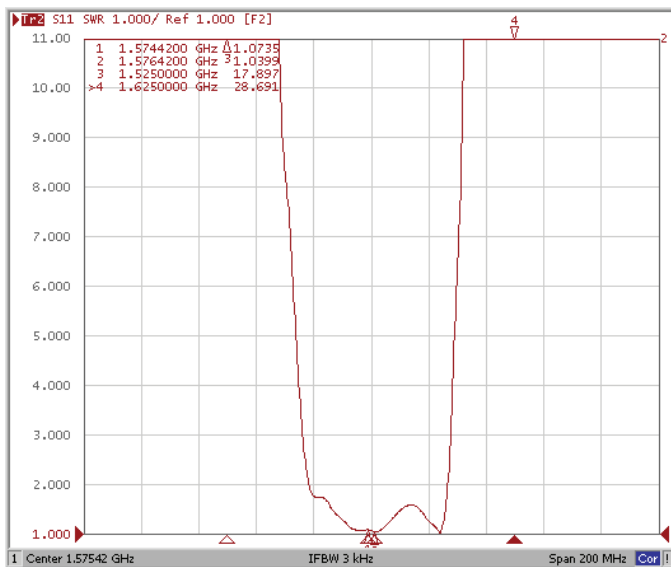

S22

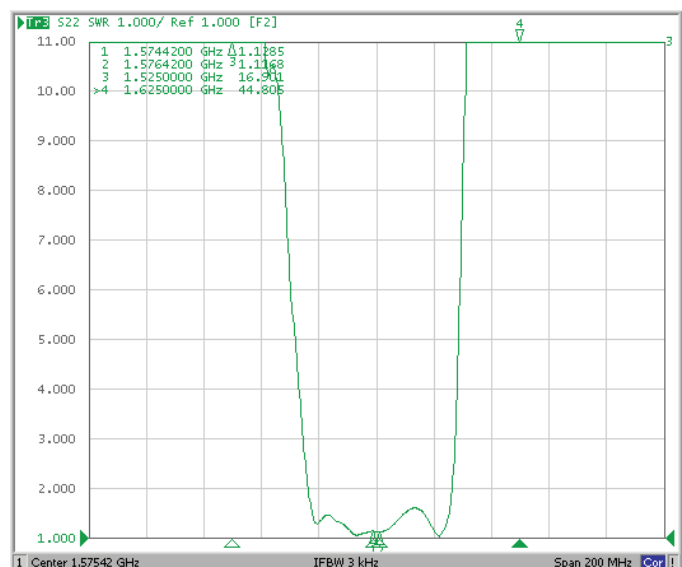

ABRACON IS  
ISO 9001:2008  
CERTIFIED



**ABRACON**  
CORPORATION

Visit [www.abracon.com](http://www.abracon.com) for Terms & Conditions of Sale  
30332 Esperanza, Rancho Santa Margarita, California 92688  
tel 949-546-8000 | fax 949-546-8001 | [www.abracon.com](http://www.abracon.com)

Revised: 04.16.13

# Surface Mount 1575.42MHz SAW Filter

AFS14A04-1575.42-T3



RoHS  
Compliant

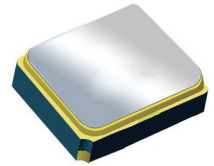

1.4 x 1.1 x 0.7 mm

## REFLOW PROFILE:

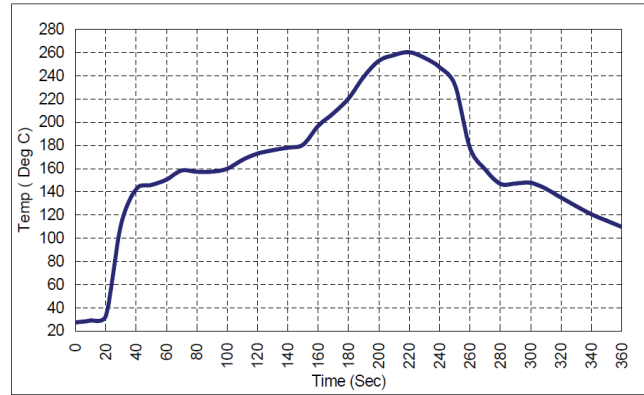

## PACKAGING: 3000 Units/Reel "T2" parts (2k/reel) are no longer available effective 01/01/2013

Reel Count : 7" = 3k units

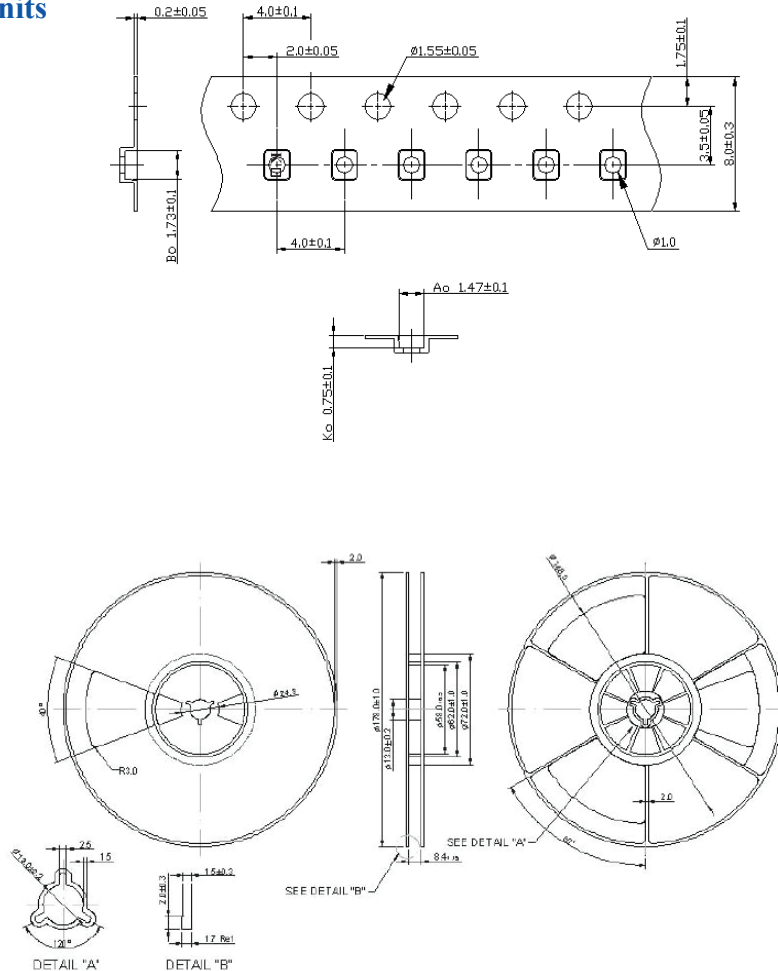

**ATTENTION:** Abracon Corporation's products are COTS – Commercial-Off-The-Shelf products; suitable for Commercial, Industrial and, where designated, Automotive Applications. Abracon's products are not specifically designed for Military, Aviation, Aerospace, Life-dependant Medical applications or any application requiring high reliability where component failure could result in loss of life and/or property. For applications requiring high reliability and/or presenting an extreme operating environment, written consent and authorization from Abracon Corporation is required. Please contact Abracon Corporation for more information.

ABRACON IS  
ISO 9001:2008  
CERTIFIED



**ABRACON**  
CORPORATION

Visit [www.abracon.com](http://www.abracon.com) for Terms & Conditions of Sale  
30332 Esperanza, Rancho Santa Margarita, California 92688  
tel 949-546-8000 | fax 949-546-8001 | [www.abracon.com](http://www.abracon.com)

Revised: 04.16.13

## Данный компонент на территории Российской Федерации

### Вы можете приобрести в компании MosChip.

Для оперативного оформления запроса Вам необходимо перейти по данной ссылке:

<http://moschip.ru/get-element>

Вы можете разместить у нас заказ для любого Вашего проекта, будь то серийное производство или разработка единичного прибора.

В нашем ассортименте представлены ведущие мировые производители активных и пассивных электронных компонентов.

Нашей специализацией является поставка электронной компонентной базы двойного назначения, продукции таких производителей как XILINX, Intel (ex.ALTERA), Vicor, Microchip, Texas Instruments, Analog Devices, Mini-Circuits, Amphenol, Glenair.

Сотрудничество с глобальными дистрибьюторами электронных компонентов, предоставляет возможность заказывать и получать с международных складов практически любой перечень компонентов в оптимальные для Вас сроки.

На всех этапах разработки и производства наши партнеры могут получить квалифицированную поддержку опытных инженеров.

Система менеджмента качества компании отвечает требованиям в соответствии с ГОСТ Р ИСО 9001, ГОСТ РВ 0015-002 и ЭС РД 009

### Офис по работе с юридическими лицами:

105318, г.Москва, ул.Щербаковская д.3, офис 1107, 1118, ДЦ «Щербаковский»

Телефон: +7 495 668-12-70 (многоканальный)

Факс: +7 495 668-12-70 (доб.304)

E-mail: [info@moschip.ru](mailto:info@moschip.ru)

Skype отдела продаж:

moschip.ru

moschip.ru\_4

moschip.ru\_6

moschip.ru\_9