



Features

- RoHS compliant*
- HCMOS, CMOS and TTL compatible
- Compact package size
- High rotational cycle life
- Standard or high force push switch option
- Optional detent



EM14 - 14 mm Rotary Optical Encoder w/Switch

Electrical Characteristics

Electrical Output.....	2-bit quadrature code
Resolution	8 to 64 pulses per revolution (PPR)
Supply Voltage (VCC)	5.0 VDC \pm 0.25 VDC
Supply Current (ICC).....	26 mA maximum
Output Voltage	
Low (VCE(sat)), per Channel.....	800 mV maximum at I(SINK) = 25 mA
High (VO(HI)), per Channel.....	4.0 VDC minimum @ VCC = 4.75 VDC
Output Current I(SINK), per Channel.....	25 mA minimum
Rise/Fall Time.....	200 ns typical
Power Dissipation.....	167 mW maximum
Pulse Width (per Channel).....	180 °e typical
Phase Angle (Channel A Leads Channel B, Clockwise Rotation).....	90 °e \pm 45 °e
Insulation Resistance @ 500 VDC.....	1,000 megohms minimum
Operating RPM	120 maximum
Switch Power Rating	12 VDC / 20 mA (600 ohms maximum load)
Switch Contact Resistance	200 ohms maximum

Environmental Characteristics

Operating Temperature Range @ 5.0 VDC	-40 °C to +70 °C (-40 °F to +158 °F)
Storage Temperature Range.....	-55 °C to +125 °C (-67 °F to +257 °F)
Vibration	15 G
Shock	50 G
Humidity	MIL-STD-202, Method 103, Condition B
Flammability	Conforms to UL 94HB
IP Rating.....	IP 54**

Mechanical Characteristics

Mechanical Angle	360 ° Continuous
Torque	
Starting/Running.....	1.06 N-cm (1.5 oz.-in.) maximum
Detent.....	1.2 N-cm (1.7 oz.-in.) typical
Rotational Life	
Non-detent (@ 30 RPM)	1,000,000 cycles (2,000,000 revolutions)
With detent (@ 30 RPM).....	100,000 cycles (200,000 revolutions)
Switch Life	100,000 cycles
Switch Actuation Force	
Standard.....	250 gm (8.82 oz.) typical
High Force.....	850 gm (29.98 oz.) typical
Switch Travel	
Standard.....	0.04 in. typical
High Force.....	0.025 in. typical
Shaft Radial Play.....	0.005 in. maximum
Shaft Axial Structural Strength	35 lbs. minimum
Mounting Torque.....	2.0 N-m (18 lb.-in.) maximum

Materials and Finishes

Terminals.....	Sn plated PC pins
Soldering Condition	
Manual Soldering	96.5Sn/3.0Ag/0.5Cu solid wire or no-clean rosin cored wire 370 °C (700 °F) max. for 3 seconds
Wave Soldering	96.5Sn/3.0Ag/0.5Cu solder with no-clean flux 260 °C (500 °F) max. for 5 seconds
Wash processes.....	Not recommended
Mounting Hardware	
Nut.....	Black anodized brass, hex (metric)/Nickel-plated brass, hex (SAE)
Lockwasher	Nickel-plated spring steel, internal tooth
Marking.....	Manufacturer's symbol, model number, product code, terminal style and date code
Standard Packaging.....	Anti-static plastic tube (25 pcs./tube)

**When device is mounted by normal mounting means.

*RoHS Directive 2002/95/EC Jan. 27, 2003 including annex and RoHS Recast 2011/65/EU June 8, 2011.
Specifications are subject to change without notice.
Customers should verify actual device performance in their specific applications.

Additional Features

- Splashproof shaft seal
- Recommended for human/machine interface applications (HMI)
- Cable/connector option
- Optional bracket

EM14 - 14 mm Rotary Optical Encoder w/Switch

BOURNS®

Part Numbering System

E M 1 4 A 0 D - C 2 4 - L 0 3 2 S

MODEL NO. DESIGNATOR	
EM14	14 mm Rotary Optical Encoder

BUSHING DESIGNATOR	
Code	Description
A	3/8 " D x 3/8 " L Threaded
C	1/4 " D x 1/4 " L Threaded
R	10 mm D x 9.5 mm L Threaded

DETENT OPTION	
Code	Description
0	No Detent
1	32 Detents (Available for 8 or 32 PPR only)

ANTI-ROTATION LUG/BRACKET OPTION	
Code	Description
A	A/R Lug
B	Bracket (No hardware/no cable or connector)
D	None

SHAFT STYLE (See Outline Drawing for Details)		
Code	Description	Available w/ Bushing
B	1/4 " Dia. Slotted End	A
C	1/4 " Dia. Flatted End	A
E	1/8 " Dia. Slotted End	C
R	6 mm Dia. Slotted End	R
M	6 mm Dia. Flatted End	R

SHAFT LENGTH DESIGNATOR		
Code	Length (FMS)	Available w/Bushing
24	3/4 "	A, C
28	7/8 "	A, C
20	20 mm	R, U
25	25 mm	R, U

SWITCH OPTION	
Code	Description
S	Push Switch (Standard)
H	Push Switch (High Force)
N	No Switch

RESOLUTION (Pulses Per Revolution)	
Code	Description
08	8 PPR
16	16 PPR
32	32 PPR
64	64 PPR

CABLE/CONNECTOR OPTION	
Code	Description
0	No Cable/Connector
1	6 " Cable with Female Connector (0.050 "/1.27 mm pitch centers in-line) and stripped/tinned leads
2	6 " Cable with Female Connector (0.050 "/1.27 mm pitch centers in-line) on both ends
3	12 " Cable with Female Connector (0.050 "/1.27 mm pitch centers in-line) and stripped/tinned leads
4	12 " Cable with Female Connector (0.050 "/1.27 mm pitch centers in-line) on both ends

TERMINAL CONFIGURATION	
Code	Description
L	Axial Multi-Purpose Pin
R	Radial Multi-Purpose Pin

Cable and Connector Options:

- H-290-4 = 6 " Cable with Female Connector (0.050 "/1.27 mm pitch centers in-line) and stripped/tinned leads
- H-290-1 = 6 " Cable with Female Connector (0.050 "/1.27 mm pitch centers in-line) on both ends
- H-290-2 = 12 " Cable with Female Connector (0.050 "/1.27 mm pitch centers in-line) and stripped/tinned leads
- H-290-3 = 12 " Cable with Female Connector (0.050 "/1.27 mm pitch centers in-line) on both ends

For other cable and connector options, please contact the factory.

Specifications are subject to change without notice. Customers should verify actual device performance in their specific applications.

EM14 - 14 mm Rotary Optical Encoder w/Switch

BOURNS®

Product Dimensions



Shaft / Flat Length Dimensions

"A" Style Bushing - Flatted Shafts

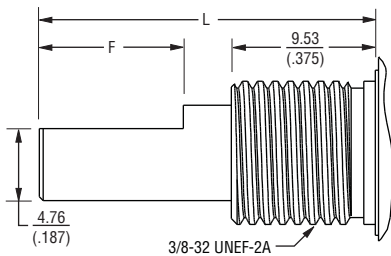

SHAFT DIA.	BUSHING DIA.	SHAFT LENGTH "L"	FLAT LENGTH "F"
6.35 (.250)	9.52 (.375)	19.05 (.750)	7.94 (.313)
		22.22 (.875)	9.52 (.375)

"R" Style Bushing - Flatted Shafts

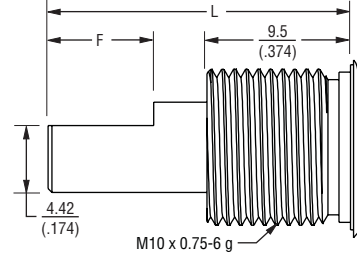

SHAFT DIA.	BUSHING DIA.	SHAFT LENGTH "L"	FLAT LENGTH "F"
6.0 (.236)	10.0 (.394)	20.0 (.787)	7.0 (.275)
		25.0 (.984)	12.0 (.472)

"C" Style Bushing - Slotted Shafts

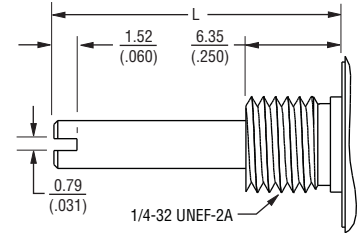

SHAFT DIA.	BUSHING DIA.	SHAFT LENGTH "L"
3.17 (.125)	6.35 (.250)	19.05 (.750)
		22.22 (.875)

"A" Style Bushing - Slotted Shafts

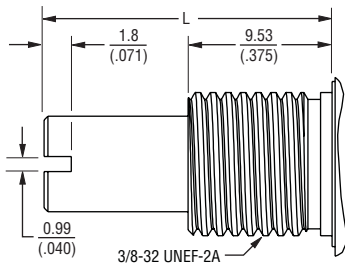

SHAFT DIA.	BUSHING DIA.	SHAFT LENGTH "L"
6.35 (.250)	9.52 (.375)	19.05 (.750)
		22.22 (.875)

"R" Style Bushing - Slotted Shafts

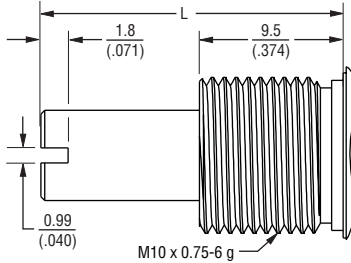

SHAFT DIA.	BUSHING DIA.	SHAFT LENGTH "L"
6.0 (.236)	10.0 (.394)	20.0 (.787)
		25.0 (.984)

DIMENSIONS: $\frac{\text{MM}}{\text{(INCHES)}}$

Specifications are subject to change without notice.
Customers should verify actual device performance in their specific applications.

EM14 - 14 mm Rotary Optical Encoder w/Switch

BOURNS®

Cable/Connector Options

Cable Assembly, Connector on One End



Cable Assembly, Connector on Both Ends



HARDWARE NUMBER	DESCRIPTION	"A" DIM.
H-290-4	CABLE ASSEMBLY, CONNECTOR ON ONE END	152.4 ± 5.0 (6.0 ± .197)
H-290-2	CABLE ASSEMBLY, CONNECTOR ON ONE END	304.8 ± 5.0 (12.0 ± .197)
H-290-1	CABLE ASSEMBLY, CONNECTOR ON BOTH ENDS	152.4 ± 5.0 (6.0 ± .197)
H-290-3	CABLE ASSEMBLY, CONNECTOR ON BOTH ENDS	304.8 ± 5.0 (12.0 ± .197)

DIMENSIONS: $\frac{\text{MM}}{\text{(INCHES)}}$

Terminal Configurations

Radial (shown with optional mounting bracket)



Recommended PCB Layout



Axial (shown with optional mounting bracket)



Recommended PCB Layout

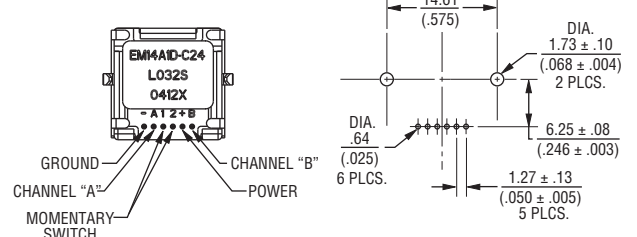

Specifications are subject to change without notice. Customers should verify actual device performance in their specific applications.

EM14 - 14 mm Rotary Optical Encoder w/Switch

BOURNS®

Electrical Block Diagram



Quadrature Output



32 DETENT / 8 PPR



32 DETENT / 32 PPR

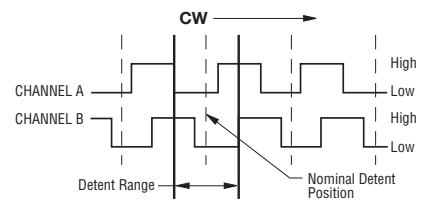

1. Nominal detent position occurs when both Channel A and B are in low states.
2. Channel A leads Channel B in CW direction and lags in CCW direction.

Terminal Diagram

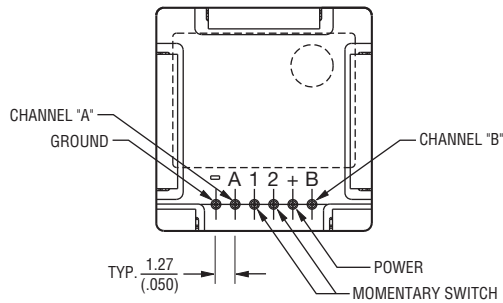

BOURNS®

Asia-Pacific: Tel: +886-2 2562-4117 • Fax: +886-2 2562-4116

Europe: Tel: +41-41 768 5555 • Fax: +41-41 768 5510

The Americas: Tel: +1-951 781-5500 • Fax: +1-951 781-5700

www.bourns.com

REV. 12/12

Specifications are subject to change without notice.
Customers should verify actual device performance in their specific applications.

Данный компонент на территории Российской Федерации

Вы можете приобрести в компании MosChip.

Для оперативного оформления запроса Вам необходимо перейти по данной ссылке:

<http://moschip.ru/get-element>

Вы можете разместить у нас заказ для любого Вашего проекта, будь то серийное производство или разработка единичного прибора.

В нашем ассортименте представлены ведущие мировые производители активных и пассивных электронных компонентов.

Нашей специализацией является поставка электронной компонентной базы двойного назначения, продукции таких производителей как XILINX, Intel (ex.ALTERA), Vicor, Microchip, Texas Instruments, Analog Devices, Mini-Circuits, Amphenol, Glenair.

Сотрудничество с глобальными дистрибьюторами электронных компонентов, предоставляет возможность заказывать и получать с международных складов практически любой перечень компонентов в оптимальные для Вас сроки.

На всех этапах разработки и производства наши партнеры могут получить квалифицированную поддержку опытных инженеров.

Система менеджмента качества компании отвечает требованиям в соответствии с ГОСТ Р ИСО 9001, ГОСТ РВ 0015-002 и ЭС РД 009

Офис по работе с юридическими лицами:

105318, г.Москва, ул.Щербаковская д.3, офис 1107, 1118, ДЦ «Щербаковский»

Телефон: +7 495 668-12-70 (многоканальный)

Факс: +7 495 668-12-70 (доб.304)

E-mail: info@moschip.ru

Skype отдела продаж:

moschip.ru

moschip.ru_4

moschip.ru_6

moschip.ru_9