



00-9176-00X-7XX-XX6

PREFIX

SERIES

NO. OF WAYS

CODE	NO. OF WAYS
001	1
002	2
003	3

WIRE GAUGE SIZE

CODE	DESCRIPTION	ACCEPTED WIRE GAUGE	WIRE INSULATION
701	CAPPED-IDC CONNECTOR	18 AWG STRANDED	Ø 1.6-2.1
711		20 AWG STRANDED	Ø 1.6-2.1
722		22 AWG STRANDED	Ø 1.1-1.6
732		24 AWG STRANDED	Ø 1.1-1.6

Elco Europe (A Division of AVX Ltd) CONFIDENTIAL PROPRIETY
The document on this print and information therewith are PROPRIETY
to Elco Europe (A Division of AVX Ltd) and shall not be copied
or disclosed in whole or in part without Elco Europe's written consent.

COLOUR OPTION

CODE	INSULATOR COLOUR	AVAILABILITY
0	BLACK	SPECIAL ORDER
1	WHITE	STANDARD

CAP OPTIONS

CODE	CAP OPTION	DESCRIPTION	DETAILS
0	THROUGH WIRE	ALLOWS WIRE TO BE TERMINATED AT ANY POINT	REFER TO SHEETS 2 TO 4
9	WIRE STOP	TERMINATES END OF WIRE END PROTECTED BY STOP FACE	REFER TO SHEETS 5 TO 7

PLATING OPTION

CODE	DESCRIPTION
6	PURE TIN ALL OVER

AVX

CONTROLLED RELEASE

ELCO EUROPE (A DIVISION OF AVX LTD.) CONFIDENTIAL PROPRIETARY
THE DRAWING ON THIS PRINT AND INFORMATION THEREWITH ARE PROPRIETARY TO ELCO EUROPE (A DIVISION OF AVX LTD.) AND SHALL NOT BE USED OR DISCLOSED IN WHOLE OR IN PART WITHOUT ELCO EUROPE'S WRITTEN CONSENT.

SHEET 1 OF 8

Release No.
History
102847
04.05.2012
18.05.2012
20.08.2012

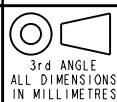

ELCO

© COPYRIGHT ELCO EUROPE
NOT TO BE DISCLOSED OR COPIED
WITHOUT WRITTEN PERMISSION

Drawn N.C.H.	Description 18-24AWG IDC WIRE TO BOARD CONNECTOR	DATE 04-Apr-12
Size CV		Issue C
Part Number 00-9176-01_700S		



**18-24 AWG 1 WAY IDC CONNECTOR
THROUGH WIRE CAPPED IDC**

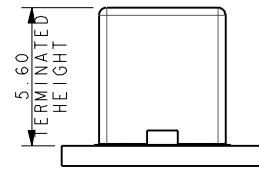
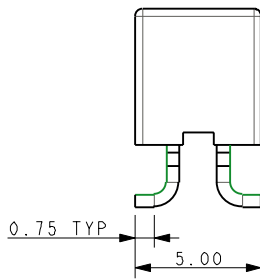
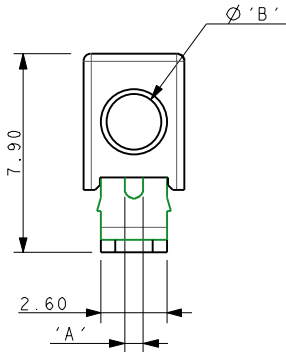
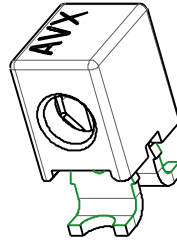
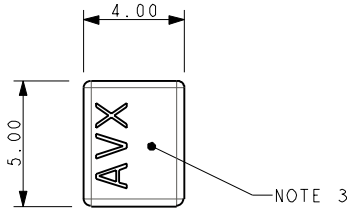

MOUNTED ON PCB

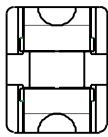

CODE	WIRE GAUGE	'A'	WIRE INSULATION	'B'
701	18AWG STRANDED	0.74	ϕ 1.6-2.1	2.1
711	20AWG STRANDED	0.60	ϕ 1.6-2.1	2.1
722	22AWG STRANDED	0.47	ϕ 1.1-1.6	1.6
732	24AWG STRANDED	0.37	ϕ 1.1-1.6	1.6

Elco Europe (A Division of AVX Ltd) CONFIDENTIAL PROPRIETY
The document on this print and information therewith are PROPRIETY
to Elco Europe (A Division of AVX Ltd) and shall not be copied
or disclosed in whole or in part without Elco Europe's written consent.

PACKING NOTES

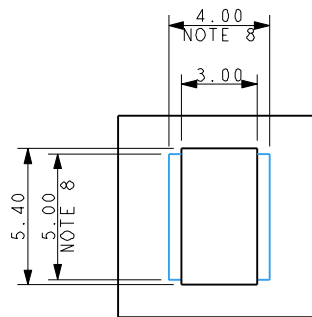
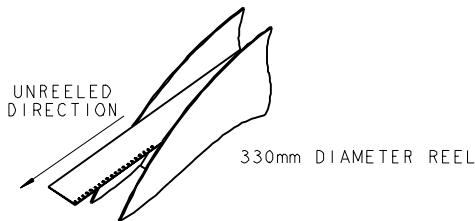

SUGGESTED PCB LAYOUT

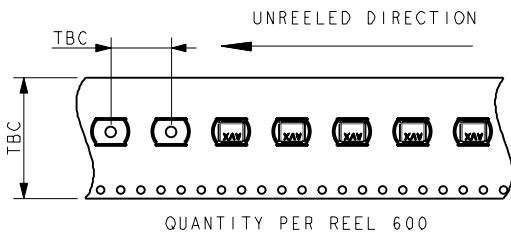

NOTES :-

1. 1 WAY CONNECTOR FOR IDC WIRE TO BOARD CONNECTION, PRE ASSEMBLED THROUGH WIRE CAP, CODE REFER TO SHEET 1.
2. CONTACT/CAP TO MATCH 18-24AWG STRANDED WIRE, INSULATION DIAMETER RANGE AS IN TABLE.
3. FLAT FACE ON TOP OF CAP TO AID PICK AND PLACE ASSEMBLY.
4. FOR FULL DETAILS REFER TO ELCO SPECIFICATION 201-01-138.
5. ASSEMBLY PROCEDURE, REFER TO APPLICATION NOTES 201-01-140.
6. GENERAL TOLERANCE ± 0.20 UNLESS STATED.
7. PACKED IN TAPE AND REEL, QUANTITY PER REEL 600.
8. CONNECTOR OUTLINE.
9. CONTACT MATERIAL :- TIN PLATED COPPER ALLOY.
10. INSULATION MATERIAL, HIGH TEMPERATURE NYLON, GLASS FILLED. UL94 V-0, COLOUR REFER TO SHEET 1.
11. GENERAL TOLERANCE ± 0.20 UNLESS STATED.

FORM-106-01-056-6 ISS 7

ELCO EUROPE (A DIVISION OF AVX LTD.) CONFIDENTIAL PROPRIETY
 THE DRAWING ON THIS PRINT AND INFORMATION THEREWITH ARE PROPRIETARY TO ELCO EUROPE (A DIVISION OF AVX LTD.) AND SHALL NOT BE USED OR DISCLOSED IN WHOLE OR IN PART WITHOUT ELCO EUROPE'S WRITTEN CONSENT.

SHEET 2 OF 8

Release No. 102847	History 04.05.2012 18.05.2012 20.08.2012
-----------------------	---



ELCO
 © COPYRIGHT ELCO EUROPE
 NOT TO BE DISCLOSED OR COPIED
 WITHOUT WRITTEN PERMISSION

Drawn N.C.H.	Description 18-24AWG IDC WIRE TO BOARD CONNECTOR	DATE 04-Apr-12
Size CV	Part Number 00-9176-01_700S	Issue C

A

B



**18-24 AWG 2 WAY IDC CONNECTOR
THROUGH WIRE CAPPED IDC**

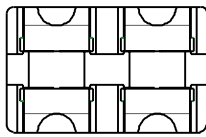
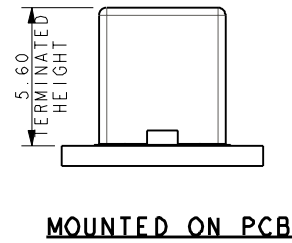
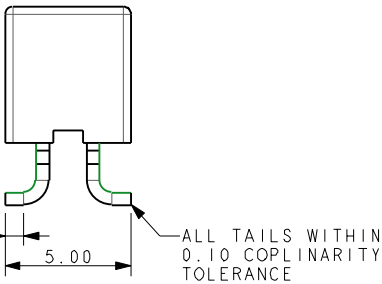
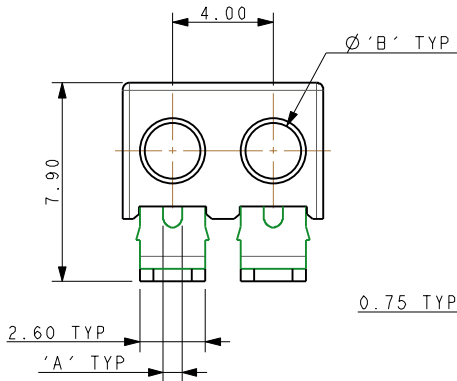
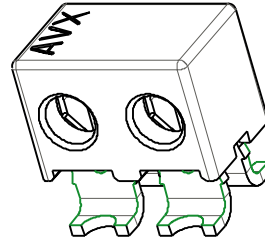
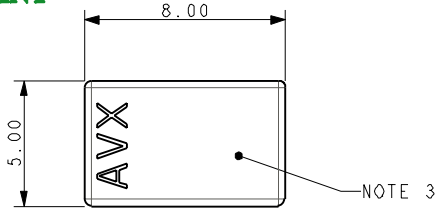

CODE	WIRE GAUGE	'A'	WIRE INSULATION	'B'
701	18AWG STRANDED	0.74	Ø 1.6-2.1	2.1
711	20AWG STRANDED	0.60	Ø 1.6-2.1	2.1
722	22AWG STRANDED	0.47	Ø 1.1-1.6	1.6
732	24AWG STRANDED	0.37	Ø 1.1-1.6	1.6

Elco Europe (A Division of AVX Ltd) CONFIDENTIAL PROPRIETY
The document on this print and information therewith are PROPRIETY to Elco Europe (A Division of AVX Ltd) and shall not be copied or disclosed in whole or in part without Elco Europe's written consent.

PACKING NOTES

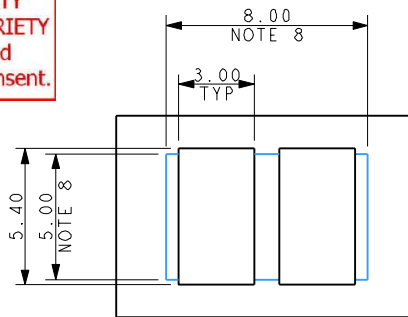
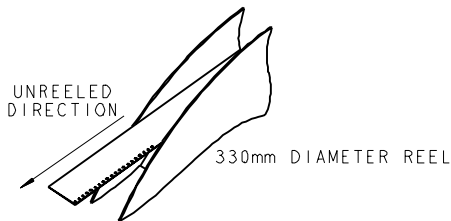

SUGGESTED PCB LAYOUT

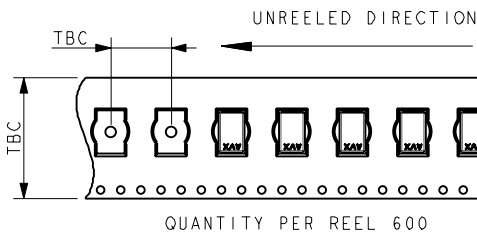

NOTES :-

- 2 WAY CONNECTOR FOR IDC WIRE TO BOARD CONNECTION, PRE ASSEMBLED THROUGH WIRE CAP, CODE REFER TO SHEET 1.
- CONTACT/CAP TO MATCH 18-24AWG STRANDED WIRE, INSULATION DIAMETER RANGE AS IN TABLE.
- FLAT FACE ON TOP OF CAP TO AID PICK AND PLACE ASSEMBLY.
- FOR FULL DETAILS REFER TO ELCO SPECIFICATION 201-01-138.
- ASSEMBLY PROCEDURE, REFER TO APPLICATION NOTES 201-01-140.
- GENERAL TOLERANCE ±0.20 UNLESS STATED.
- PACKED IN TAPE AND REEL, QUANTITY PER REEL 600.
- CONNECTOR OUTLINE.
- CONTACT MATERIAL :- TIN PLATED COPPER ALLOY.
- INSULATION MATERIAL, HIGH TEMPERATURE NYLON, GLASS FILLED. UL94 V-0, COLOUR REFER TO SHEET 1.
- GENERAL TOLERANCE ±0.20 UNLESS STATED.

ELCO EUROPE (A DIVISION OF AVX LTD.) CONFIDENTIAL PROPRIETY
THE DRAWING ON THIS PRINT AND INFORMATION THEREWITH ARE PROPRIETY TO ELCO EUROPE (A DIVISION OF AVX LTD.) AND SHALL NOT BE USED OR DISCLOSED IN WHOLE OR IN PART WITHOUT ELCO EUROPE'S WRITTEN CONSENT.

SHEET 3 OF 8

Release No.
History
102847
04.05.2012
18.05.2012
20.08.2012

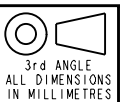

Drawn N.C.H.	Description 18-24AWG IDC WIRE TO BOARD CONNECTOR	DATE 04-Apr-12
Size CV	Part Number 00-9176-01_700S	Issue C

A

B



**18-24 AWG 3 WAY IDC CONNECTOR
THROUGH WIRE CAPPED IDC**

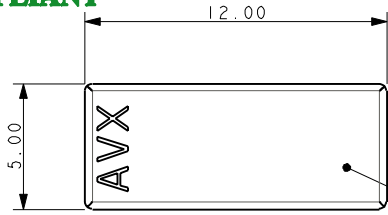

NOTES 3

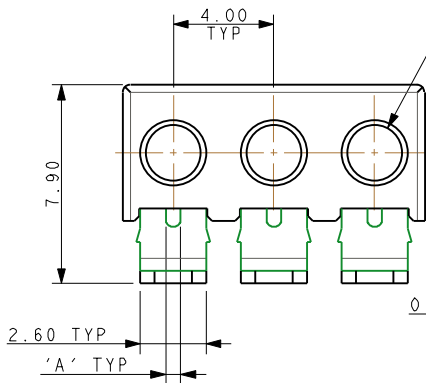
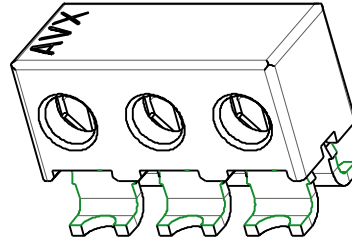

Ø 'B' TYP

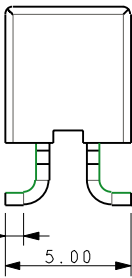

ALL TAILS WITHIN 0.10 COPLANARITY TOLERANCE

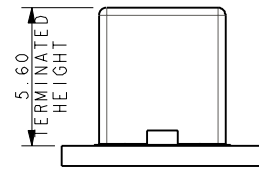

MOUNTED ON PCB

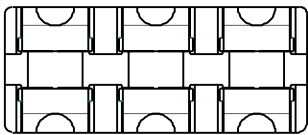

CODE	WIRE GAUGE	'A'	WIRE INSULATION	'B'
701	18AWG STRANDED	0.74	Ø 1.6-2.1	2.1
711	20AWG STRANDED	0.60	Ø 1.6-2.1	2.1
722	22AWG STRANDED	0.47	Ø 1.1-1.6	1.6
732	24AWG STRANDED	0.37	Ø 1.1-1.6	1.6

Elco Europe (A Division of AVX Ltd) CONFIDENTIAL PROPRIETY
The document on this print and information therewith are PROPRIETY to Elco Europe (A Division of AVX Ltd) and shall not be copied or disclosed in whole or in part without Elco Europe's written consent.

PACKING NOTES

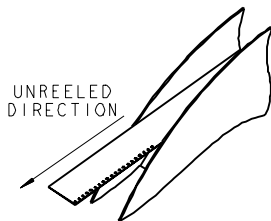

330mm DIAMETER REEL

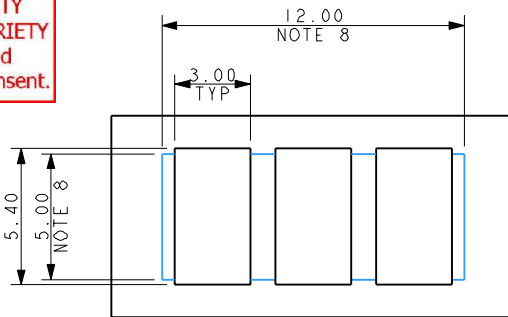

SUGGESTED PCB LAYOUT

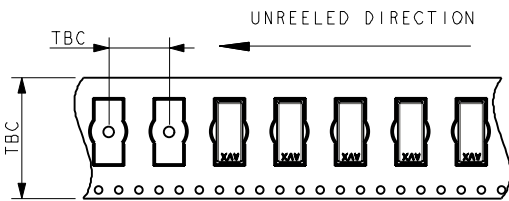

QUANTITY PER REEL 600

NOTES :-

- 3 WAY CONNECTOR FOR IDC WIRE TO BOARD CONNECTION, PRE ASSEMBLED THROUGH WIRE CAP, CODE REFER TO SHEET 1.
- CONTACT/CAP TO MATCH 18-24AWG STRANDED WIRE, INSULATION DIAMETER RANGE AS IN TABLE.
- FLAT FACE ON TOP OF CAP TO AID PICK AND PLACE ASSEMBLY.
- FOR FULL DETAILS REFER TO ELCO SPECIFICATION 201-01-138.
- ASSEMBLY PROCEDURE, REFER TO APPLICATION NOTES 201-01-140.
- GENERAL TOLERANCE ±0.20 UNLESS STATED.
- PACKED IN TAPE AND REEL, QUANTITY PER REEL 600.
- CONNECTOR OUTLINE.
- CONTACT MATERIAL :- TIN PLATED COPPER ALLOY.
- INSULATION MATERIAL, HIGH TEMPERATURE NYLON, GLASS FILLED.
- UL94 V-0, COLOUR REFER TO SHEET 1.
- GENERAL TOLERANCE ±0.20 UNLESS STATED.

ELCO EUROPE (A DIVISION OF AVX LTD.) CONFIDENTIAL PROPRIETY
THE DRAWING ON THIS PRINT AND INFORMATION THEREWITH ARE PROPRIETY TO ELCO EUROPE (A DIVISION OF AVX LTD.) AND SHALL NOT BE USED OR DISCLOSED IN WHOLE OR IN PART WITHOUT ELCO EUROPE'S WRITTEN CONSENT.

SHEET 4 OF 8

FORM-106-01-056-6 ISS 7
Release No. 102847
History 04.05.2012
18.05.2012
20.08.2012

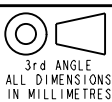

Drawn N.C.H.	Description 18-24AWG IDC WIRE TO BOARD CONNECTOR	DATE 04-Apr-12
Size CV	Part Number 00-9176-01_700S	Issue C



**18-24 AWG 1 WAY IDC CONNECTOR
WIRE STOP CAPPED-IDC**

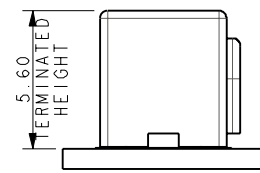
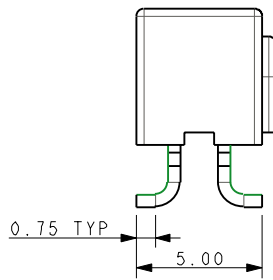
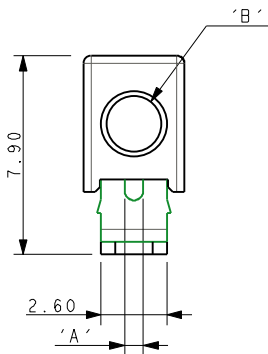
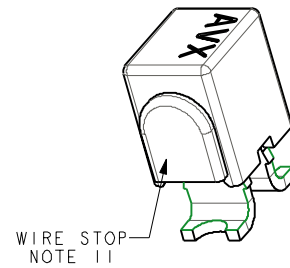
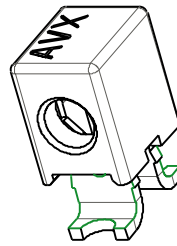
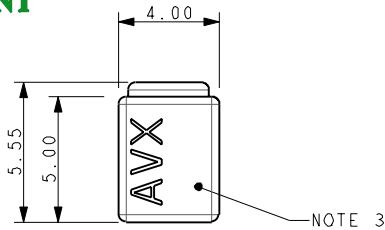

MOUNTED ON PCB

CODE	WIRE GAUGE	'A'	WIRE INSULATION	'B'
701	18AWG STRANDED	0.74	Ø 1.6-2.1	2.1
711	20AWG STRANDED	0.60	Ø 1.6-2.1	2.1
722	22AWG STRANDED	0.47	Ø 1.1-1.6	1.6
732	24AWG STRANDED	0.37	Ø 1.1-1.6	1.6

Elco Europe (A Division of AVX Ltd) CONFIDENTIAL PROPRIETY
The document on this print and information therewith are PROPRIETY
to Elco Europe (A Division of AVX Ltd) and shall not be copied
or disclosed in whole or in part without Elco Europe's written consent.

PACKING NOTES

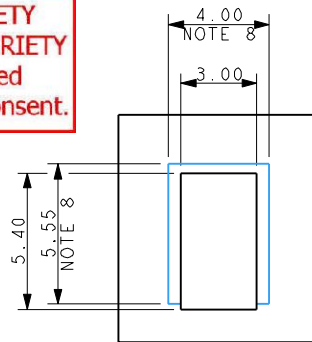
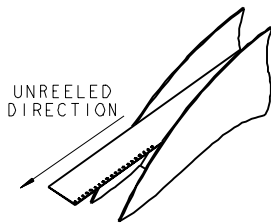

SUGGESTED PCB LAYOUT

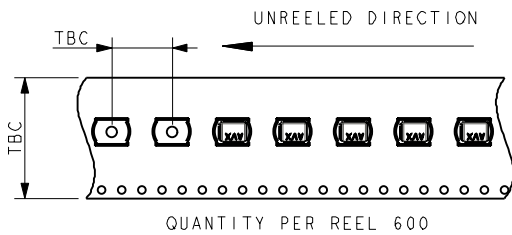

NOTES :-

1. 1 WAY CONNECTOR FOR IDC WIRE TO BOARD CONNECTION, PRE ASSEMBLED WIRE STOP CAP, CODE REFER TO SHEET 1.
2. CONTACT/CAP TO MATCH 18-24AWG STRANDED WIRE, INSULATION DIAMETER RANGE AS IN TABLE.
3. FLAT FACE ON TOP OF CAP TO AID PICK AND PLACE ASSEMBLY.
4. FOR FULL DETAILS REFER TO ELCO SPECIFICATION 201-01-138.
5. ASSEMBLY PROCEDURE, REFER TO APPLICATION NOTES 201-01-140.
6. GENERAL TOLERANCE ±0.20 UNLESS STATED.
7. PACKED IN TAPE AND REEL, QUANTITY PER REEL 600.
8. CONNECTOR OUTLINE.
9. CONTACT MATERIAL :- TIN PLATED COPPER ALLOY.
10. INSULATION MATERIAL, HIGH TEMPERATURE NYLON, GLASS FILLED, UL94 V-0, COLOUR REFER TO SHEET 1.
11. WIRE STOP CAP PROTECTS END OF WIRE.
12. GENERAL TOLERANCE ±0.20 UNLESS STATED.

ELCO EUROPE (A DIVISION OF AVX LTD.) CONFIDENTIAL PROPRIETY
 THE DRAWING ON THIS PRINT AND INFORMATION THEREWITH ARE PROPRIETY TO ELCO EUROPE (A DIVISION OF AVX LTD.) AND SHALL NOT BE USED OR DISCLOSED IN WHOLE OR IN PART WITHOUT ELCO EUROPE'S WRITTEN CONSENT.

SHEET 5 OF 8

Release No.
 History
 102847
 04.05.2012
 18.05.2012
 20.08.2012

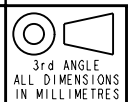

Drawn N.C.H.	Description 18-24AWG IDC WIRE TO BOARD CONNECTOR	DATE 04-Apr-12
Size CV	Part Number 00-9176-01_700S	Issue C

A

B



**18-24 AWG 2 WAY IDC CONNECTOR
WIRE STOP CAPPED IDC**

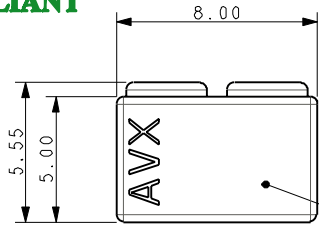

NOTE 3

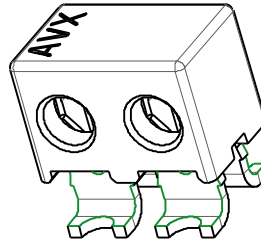

WIRE STOP
NOTE 11

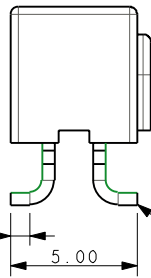
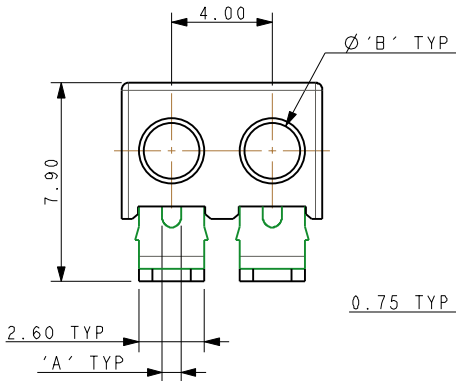
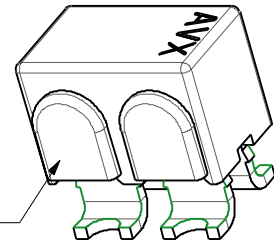

ALL TAILS WITHIN
0.10 COPLANARITY
TOLERANCE

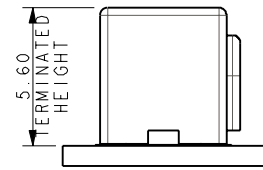

MOUNTED ON PCB

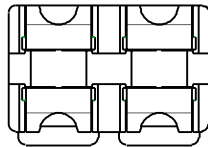

CODE	WIRE GAUGE	'A'	WIRE INSULATION	'B'
701	18AWG STRANDED	0.74	Ø 1.6-2.1	2.1
711	20AWG STRANDED	0.60	Ø 1.6-2.1	2.1
722	22AWG STRANDED	0.47	Ø 1.1-1.6	1.6
732	24AWG STRANDED	0.37	Ø 1.1-1.6	1.6

Elco Europe (A Division of AVX Ltd) CONFIDENTIAL PROPRIETY
The document on this print and information therewith are PROPRIETY
to Elco Europe (A Division of AVX Ltd) and shall not be copied
or disclosed in whole or in part without Elco Europe's written consent.

PACKING NOTES

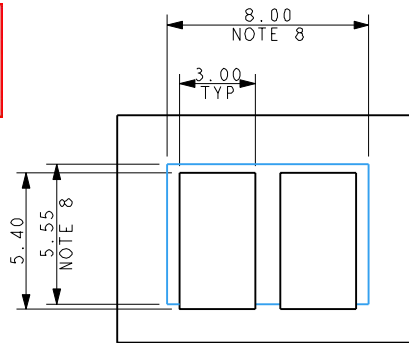
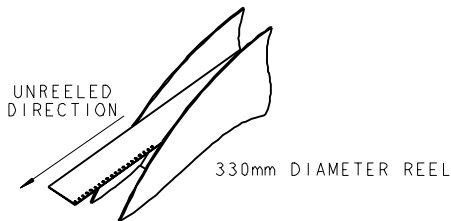

SUGGESTED PCB LAYOUT

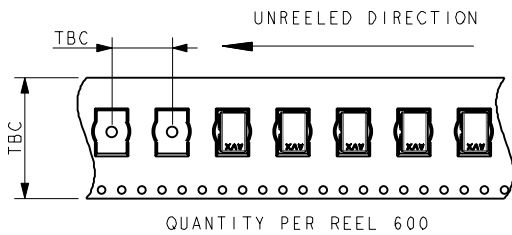

NOTES :-

- 2 WAY CONNECTOR FOR IDC WIRE TO BOARD CONNECTION, PRE ASSEMBLED WIRE STOP CAP, CODE REFER TO SHEET 1.
- CONTACT/CAP TO MATCH 18-24AWG STRANDED WIRE, INSULATION DIAMETER RANGE AS IN TABLE.
- FLAT FACE ON TOP OF CAP TO AID PICK AND PLACE ASSEMBLY.
- FOR FULL DETAILS REFER TO ELCO SPECIFICATION 201-01-138.
- ASSEMBLY PROCEDURE, REFER TO APPLICATION NOTES 201-01-140.
- GENERAL TOLERANCE ±0.20 UNLESS STATED.
- PACKED IN TAPE AND REEL, QUANTITY PER REEL 600.
- CONNECTOR OUTLINE.
- CONTACT MATERIAL :- TIN PLATED COPPER ALLOY.
- INSULATION MATERIAL, HIGH TEMPERATURE NYLON, GLASS FILLED. UL94 V-0, COLOUR REFER TO SHEET 1.
- WIRE STOP CAP PROTECTS END OF WIRE.
- GENERAL TOLERANCE ±0.20 UNLESS STATED.

SHEET 6 OF 8

FORM-106-01-056-6 ISS 7

ELCO EUROPE (A DIVISION OF AVX LTD.) CONFIDENTIAL PROPRIETY
THE DRAWING ON THIS PRINT AND INFORMATION THEREWITH ARE
PROPRIETY TO ELCO EUROPE (A DIVISION OF AVX LTD.) AND
SHALL NOT BE USED OR DISCLOSED IN WHOLE OR IN PART
WITHOUT ELCO EUROPE'S WRITTEN CONSENT.

Release No.
History
102847
04.05.2012
18.05.2012
20.08.2012

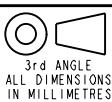

Drawn N.C.H.	Description 18-24AWG IDC WIRE TO BOARD CONNECTOR	DATE 04-Apr-12
Size CV	Part Number 00-9176-01_700S	Issue C

A

B



**18-24 AWG 3 WAY IDC CONNECTOR
WIRE STOP CAPPED IDC**

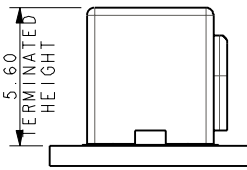
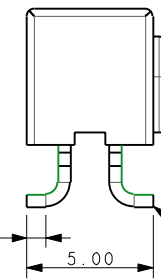
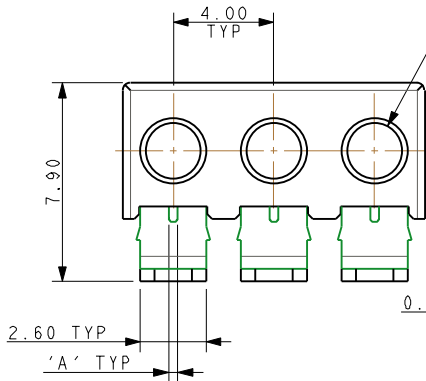
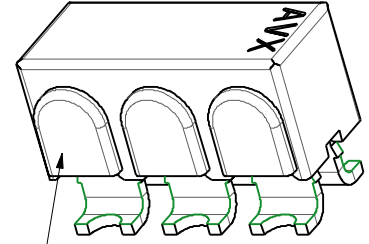
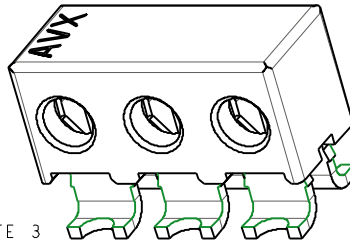
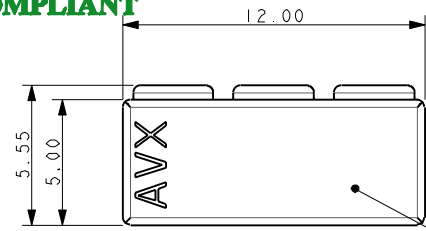

ALL TAILS WITHIN 0.10 COPLANARITY TOLERANCE

MOUNTED ON PCB

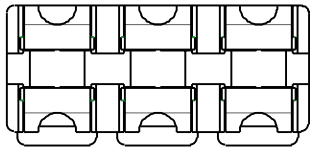

CODE	WIRE GAUGE	'A'	WIRE INSULATION	'B'
701	18AWG STRANDED	0.74	Ø 1.6-2.1	2.1
711	20AWG STRANDED	0.60	Ø 1.6-2.1	2.1
722	22AWG STRANDED	0.47	Ø 1.1-1.6	1.6
732	24AWG STRANDED	0.37	Ø 1.1-1.6	1.6

Elco Europe (A Division of AVX Ltd) CONFIDENTIAL PROPRIETY
The document on this print and information therewith are PROPRIETY to Elco Europe (A Division of AVX Ltd) and shall not be copied or disclosed in whole or in part without Elco Europe's written consent.

PACKING NOTES

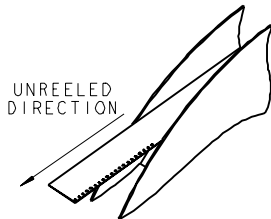

330mm DIAMETER REEL

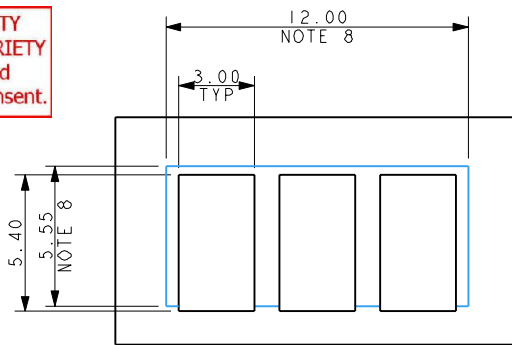

SUGGESTED PCB LAYOUT

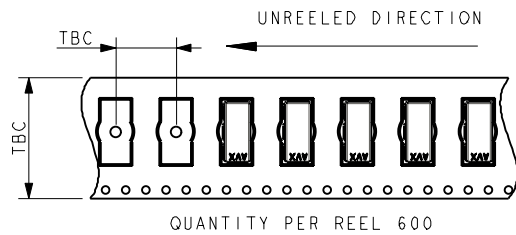

NOTES :-

- 3 WAY CONNECTOR FOR IDC WIRE TO BOARD CONNECTION, PRE ASSEMBLED WIRE STOP CAP, CODE REFER TO SHEET 1.
- CONTACT/CAP TO MATCH 18-24AWG STRANDED WIRE, INSULATION DIAMETER RANGE AS IN TABLE.
- FLAT FACE ON TOP OF CAP TO AID PICK AND PLACE ASSEMBLY.
- FOR FULL DETAILS REFER TO ELCO SPECIFICATION 201-01-138.
- ASSEMBLY PROCEDURE, REFER TO APPLICATION NOTES 201-01-140.
- GENERAL TOLERANCE ±0.20 UNLESS STATED.
- PACKED IN TAPE AND REEL, QUANTITY PER REEL 600.
- CONNECTOR OUTLINE.
- CONTACT MATERIAL :- TIN PLATED COPPER ALLOY.
- INSULATION MATERIAL, HIGH TEMPERATURE NYLON, GLASS FILLED. UL94 V-0, COLOUR REFER TO SHEET 1.
- WIRE STOP CAP PROTECTS END OF WIRE.
- GENERAL TOLERANCE ±0.20 UNLESS STATED.

SHEET 7 OF 8

FORM-106-01-056-6 ISS 7

ELCO EUROPE (A DIVISION OF AVX LTD.) CONFIDENTIAL PROPRIETY
THE DRAWING ON THIS PRINT AND INFORMATION THEREWITH ARE PROPRIETY TO ELCO EUROPE (A DIVISION OF AVX LTD.) AND SHALL NOT BE USED OR DISCLOSED IN WHOLE OR IN PART WITHOUT ELCO EUROPE'S WRITTEN CONSENT.

Release No.
History
102847
04.05.2012
18.05.2012
20.08.2012

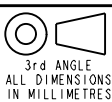

Drawn N.C.H.	Description 18-24AWG IDC WIRE TO BOARD CONNECTOR	DATE 04-Apr-12
Size CV	Part Number 00-9176-01_700S	Issue C

A

B

A

B



18-24 AWG ASSEMBLED CAPPED IDC CONNECTORS

Elco Europe (A Division of AVX Ltd) CONFIDENTIAL PROPRIETY
 The document on this print and information therewith are PROPRIETY
 to Elco Europe (A Division of AVX Ltd) and shall not be copied
 or disclosed in whole or in part without Elco Europe's written consent.

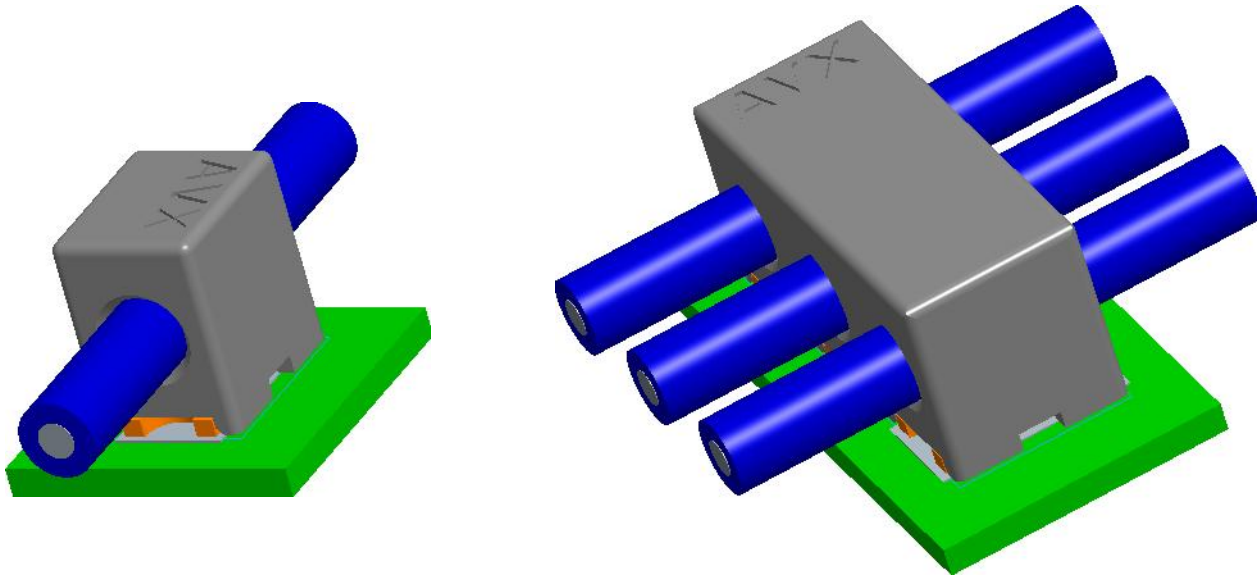

TYPICAL THROUGH WIRE ASSEMBLIES

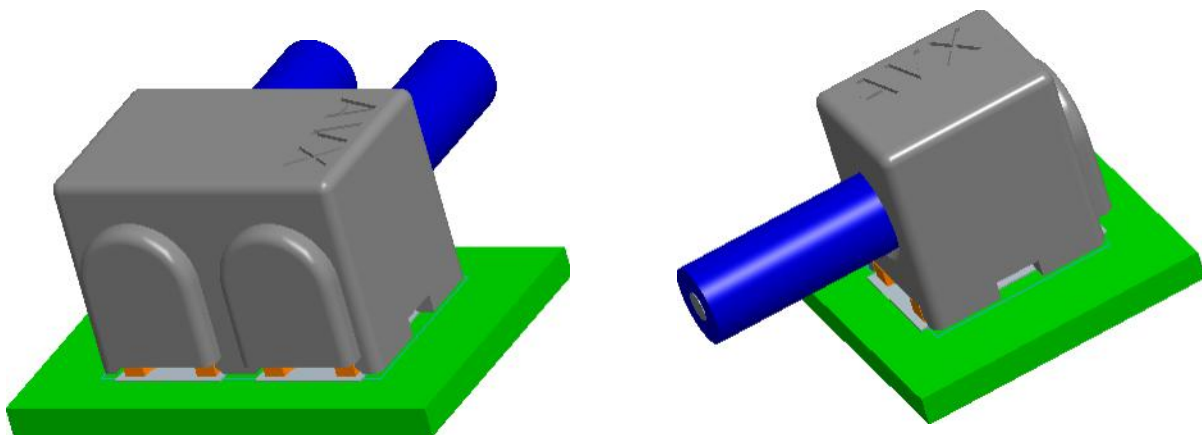

TYPICAL WIRE STOP ASSEMBLIES

FORM-106-01-036-6 ISS 7

ELCO EUROPE (A DIVISION OF AVX LTD.) CONFIDENTIAL PROPRIETY
 THE DRAWING ON THIS PRINT AND INFORMATION THEREWITH ARE
 PROPRIETARY TO ELCO EUROPE (A DIVISION OF AVX LTD.) AND
 SHALL NOT BE USED OR DISCLOSED IN WHOLE OR IN PART
 WITHOUT ELCO EUROPE'S WRITTEN CONSENT.

SHEET 8 OF 8

Release No.
 History
 102847
 04.05.2012
 18.05.2012
 20.08.2012

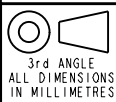

ELCO
 © COPYRIGHT ELCO EUROPE
 NOT TO BE DISCLOSED OR COPIED
 WITHOUT WRITTEN PERMISSION

Drawn
 N.C.H.
 Size
 CV

Description
 18-24AWG IDC WIRE TO BOARD CONNECTOR
 Part Number
 00-9176-01_700S

DATE
 04-Apr-12
 Issue
 C

A

B

Данный компонент на территории Российской Федерации

Вы можете приобрести в компании MosChip.

Для оперативного оформления запроса Вам необходимо перейти по данной ссылке:

<http://moschip.ru/get-element>

Вы можете разместить у нас заказ для любого Вашего проекта, будь то серийное производство или разработка единичного прибора.

В нашем ассортименте представлены ведущие мировые производители активных и пассивных электронных компонентов.

Нашей специализацией является поставка электронной компонентной базы двойного назначения, продукции таких производителей как XILINX, Intel (ex.ALTERA), Vicor, Microchip, Texas Instruments, Analog Devices, Mini-Circuits, Amphenol, Glenair.

Сотрудничество с глобальными дистрибьюторами электронных компонентов, предоставляет возможность заказывать и получать с международных складов практически любой перечень компонентов в оптимальные для Вас сроки.

На всех этапах разработки и производства наши партнеры могут получить квалифицированную поддержку опытных инженеров.

Система менеджмента качества компании отвечает требованиям в соответствии с ГОСТ Р ИСО 9001, ГОСТ РВ 0015-002 и ЭС РД 009

Офис по работе с юридическими лицами:

105318, г.Москва, ул.Щербаковская д.3, офис 1107, 1118, ДЦ «Щербаковский»

Телефон: +7 495 668-12-70 (многоканальный)

Факс: +7 495 668-12-70 (доб.304)

E-mail: info@moschip.ru

Skype отдела продаж:

moschip.ru

moschip.ru_4

moschip.ru_6

moschip.ru_9