

## TINA3-OO

~60° + 40° oval beam. Assembly with holder, installation tape and location pins.

### TECHNICAL SPECIFICATIONS:

Dimensions	Ø 16.1 mm
Height	6.9 mm
Fastening	tape, pin
ROHS compliant	yes ⓘ

### MATERIAL SPECIFICATIONS:

Component	Type	Material	Colour	Finish
TINA3-OO-XP	Single lens	PMMA	clear	
TINA3-HLD-PIN-TAPE	Holder	PC	white	
TINA-TAPE3	Tape	PU tape	black	

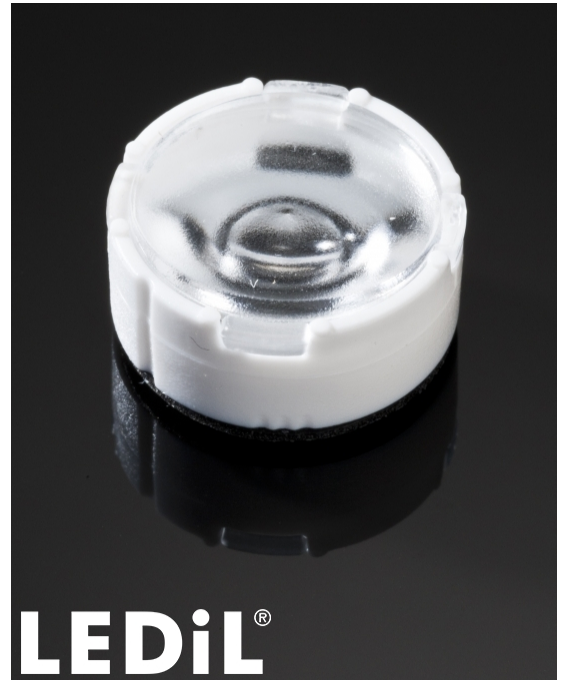

### ORDERING INFORMATION:

Component		Qty in box	MOQ	MPQ	Box weight (kg)
CA12429_TINA3-OO	Single lens	5750		230	9.0
» Box size: 451 x 241 x 298 mm					

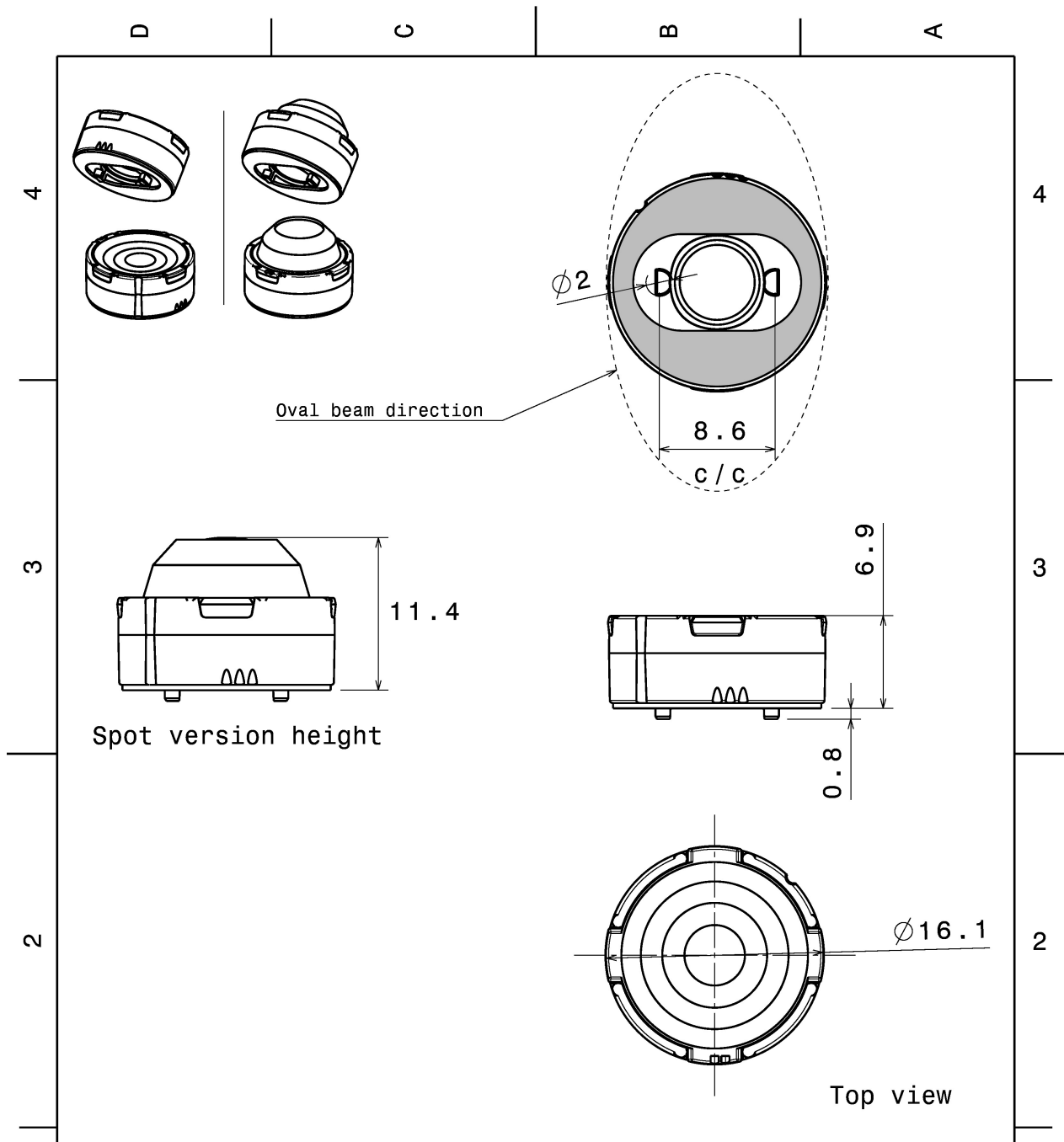

Tolerances if not otherwise shown  
According to DIN ISO 2768-1  
Linear measures:  
Up to 30mm class M, otherwise class C.  
According to DIN ISO 2768-2  
Form and position: class L

**LEDiL** LediL Oy  
Salorankatu 10  
FIN 24240 SALO  
Finland

THIRD ANGLE PROJECTION:

DRAWING TITLE  
**TINA3 Datasheet**

This drawing is the property of LEDiL Oy. It may not be reproduced, copied or communicated without a written agreement with LEDiL Oy."

SIZE	PART NUMBER
A4	-

SCALE	4:3	WEIGHT	-	SHEET	1/1
-------	-----	--------	---	-------	-----

#### PHOTOMETRIC DATA (MEASURED):



LED XP-G  
 FWHM 51.0 + 35.0°  
 Efficiency 90 %  
 Peak intensity 1.4 cd/lm  
 LEDs/each optic 1  
 Light colour White  
 Required components:

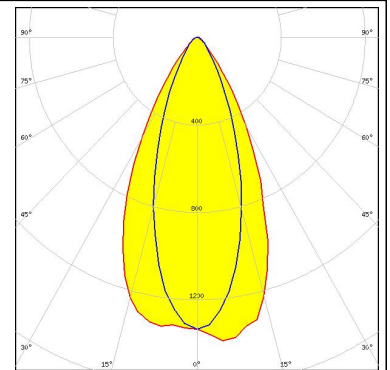

LED LUXEON A  
 FWHM 57.0 + 29.0°  
 Efficiency 90 %  
 Peak intensity 1.2 cd/lm  
 LEDs/each optic 1  
 Light colour White  
 Required components:

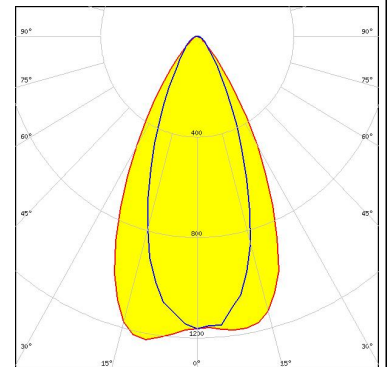

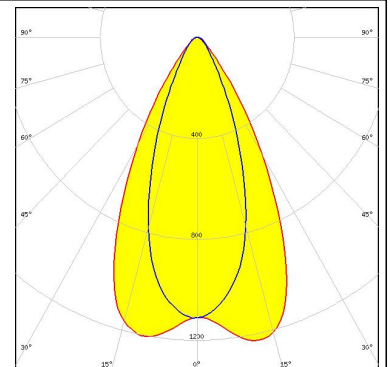
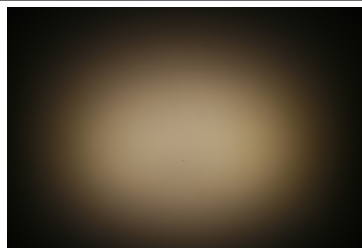

LED LUXEON T  
 FWHM 58.0 + 40.0°  
 Efficiency 88 %  
 Peak intensity 1.2 cd/lm  
 LEDs/each optic 1  
 Light colour White  
 Required components:

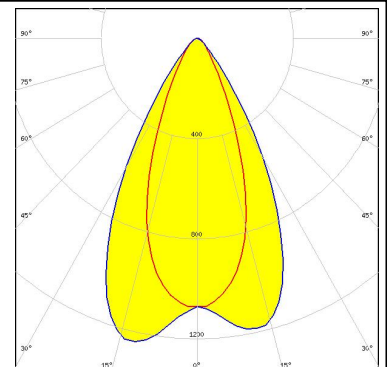
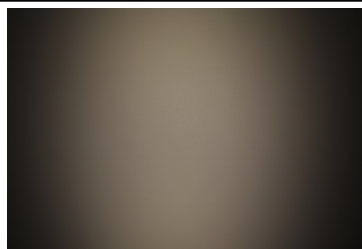

LED LUXEON TX  
 FWHM 59.0 + 42.0°  
 Efficiency 88 %  
 Peak intensity 1.2 cd/lm  
 LEDs/each optic 1  
 Light colour White  
 Required components:

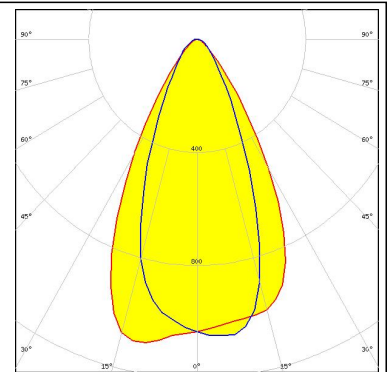

#### PHOTOMETRIC DATA (MEASURED):

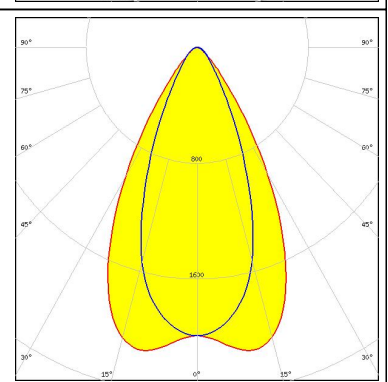
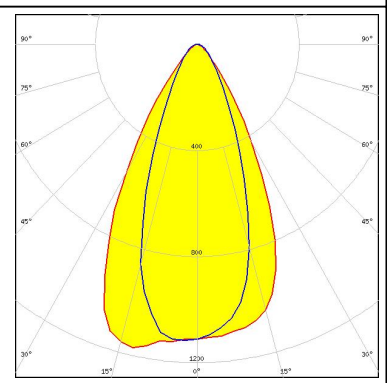
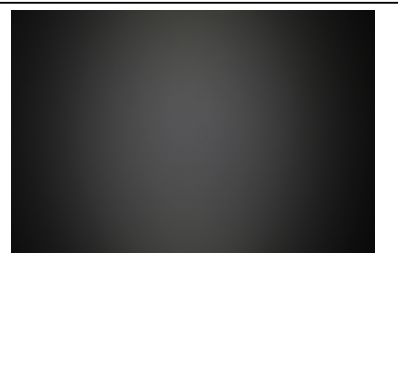
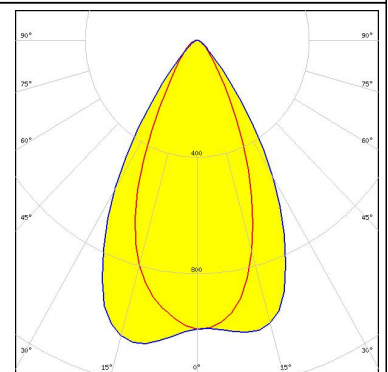
<p><b>NICHIA</b></p> <p>LED NVSxx19A            FWHM 61.0 + 45.0°            Efficiency 87 %            Peak intensity 1 cd/lm            LEDs/each optic 1            Light colour White            Required components:</p>		
<p><b>NICHIA</b></p> <p>LED NVSxx19B/NVSxx19C            FWHM 43.0°            Efficiency 86 %            Peak intensity 1.1 cd/lm            LEDs/each optic 1            Light colour White            Required components:</p>		
<p><b>OSRAM</b>  <small>Opto Semiconductors</small></p> <p>LED OSOLON Square EC            FWHM 55.0 + 39.0°            Efficiency 88 %            Peak intensity 1.1 cd/lm            LEDs/each optic 1            Light colour White            Required components:</p>		
<p><b>SAMSUNG</b></p> <p>LED LH351Z            FWHM 47.0 + 62.0°            Efficiency 88 %            Peak intensity 1.1 cd/lm            LEDs/each optic 1            Light colour White            Required components:</p>		

#### PHOTOMETRIC DATA (SIMULATED):



LED LUXEON H50-2  
FWHM 37.0 + 57.0°  
Efficiency 87 %  
Peak intensity 1.3 cd/lm  
LEDs/each optic 1  
Light colour White  
Required components:

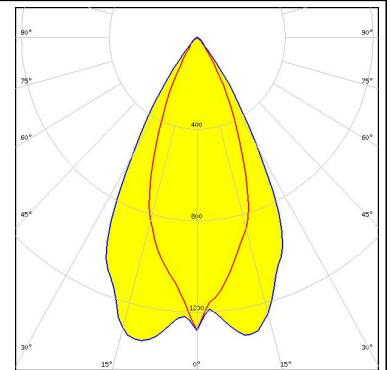

LED OSCONIQ P 3030  
FWHM 52.0 + 29.0°  
Efficiency 94 %  
Peak intensity 2 cd/lm  
LEDs/each optic 1  
Light colour White  
Required components:

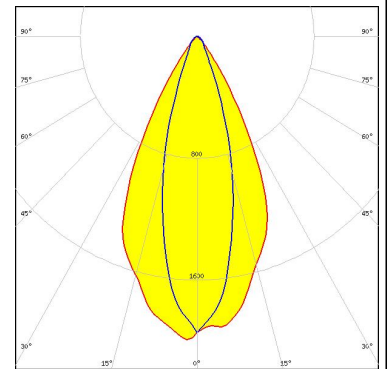

### GENERAL INFORMATION:

NOTE: The typical beam angle will be changed by different color, chip size and chip position tolerance. The typical total beam angle is the full angle measured where the luminous intensity is half of the peak value.

### MATERIALS:

As part of our continuous research and improvement processes, and to ensure the best possible quality and availability of our products, LEDiL reserves the right to change material grades without notice.

### PRODUCT DATA USER AGREEMENT AND DISCLAIMER:

The measured data in the provided downloadable LEDiL Product Datasheets and Mechanical 2D-Drawings is rounded and provided as reference for planning. LEDiL Oy's optical specifications have been verified by conducting performance testing of the products in accordance with the company's quality system. The reported data are averaged results of multiple measurements with typical variation. LEDiL Oy reserves the right to without prior notification make changes and improvements to its products.

LEDiL Oy assumes neither warranty, nor guarantee nor any other liability of any kind for the contents and correctness of the provided data. The provided data has been generated with highest diligence but the provided data may in reality not represent the complete possible variation range of all intrinsic parameters. Therefore, in certain cases a deviation from the provided data could occur.

LEDiL Oy reserves the right to undertake technical changes of its products without further notification which could lead to changes in the provided data. LEDiL Oy assumes no liability of any kind for the possible deviation from any provided data or any other damage resulting from the usage of the provided data.

The user agrees to this disclaimer and user agreement with the download or usage of the provided files.

#### LEDiL Oy

Joensuunkatu 13  
FI-24240 SALO  
Finland

#### LEDiL Inc.

228 West Page Street  
Suite D  
Sycamore IL 60178  
USA

#### Local sales and technical support

[www.ledil.com/  
where\\_to\\_buy](http://www.ledil.com/where_to_buy)

#### Shipping locations

Salo, Finland  
Hong Kong, China

#### Distribution Partners

[www.ledil.com/  
where\\_to\\_buy](http://www.ledil.com/where_to_buy)

## Данный компонент на территории Российской Федерации

### Вы можете приобрести в компании MosChip.

Для оперативного оформления запроса Вам необходимо перейти по данной ссылке:

<http://moschip.ru/get-element>

Вы можете разместить у нас заказ для любого Вашего проекта, будь то серийное производство или разработка единичного прибора.

В нашем ассортименте представлены ведущие мировые производители активных и пассивных электронных компонентов.

Нашей специализацией является поставка электронной компонентной базы двойного назначения, продукции таких производителей как XILINX, Intel (ex.ALTERA), Vicor, Microchip, Texas Instruments, Analog Devices, Mini-Circuits, Amphenol, Glenair.

Сотрудничество с глобальными дистрибьюторами электронных компонентов, предоставляет возможность заказывать и получать с международных складов практически любой перечень компонентов в оптимальные для Вас сроки.

На всех этапах разработки и производства наши партнеры могут получить квалифицированную поддержку опытных инженеров.

Система менеджмента качества компании отвечает требованиям в соответствии с ГОСТ Р ИСО 9001, ГОСТ РВ 0015-002 и ЭС РД 009

### Офис по работе с юридическими лицами:

105318, г.Москва, ул.Щербаковская д.3, офис 1107, 1118, ДЦ «Щербаковский»

Телефон: +7 495 668-12-70 (многоканальный)

Факс: +7 495 668-12-70 (доб.304)

E-mail: [info@moschip.ru](mailto:info@moschip.ru)

Skype отдела продаж:

moschip.ru

moschip.ru\_4

moschip.ru\_6

moschip.ru\_9