

10/100/1000BASE-T SINGLE & DUAL-PORT TRANSFORMER MODULES

Military / Aerospace Grade

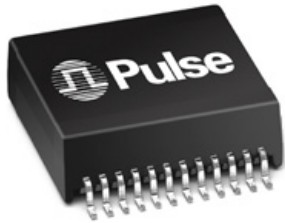
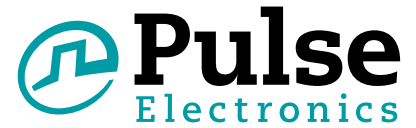

- Compliant with IEEE 802.ab for 1000Base-T
- 350µH OCL with 8mA bias at extended temperatures
- Two Operating and Storage Temperature Versions Available:
 - Standard: **-40°C to +85°C**
 - Extended: **-55°C to +125°C**
- IC grade transfer molded package 235°C peak reflow temperature for non-RoHS versions (MSL 3)
- 245°C peak reflow temperature for RoHS versions (MSL 4)
- Lead finish: Sn63/Pb37 (RoHS compliant version available with 100% pure tin)

Electrical Specifications @ 25°C — Operating Temperature -40°C to +85°C

Part Number ²	Insertion Loss (dB Min)	Return Loss (dB Max)				Crosstalk (dB Max)			CM to CM Rejection Ratio (dB Max)			DM to CM Rejection Ratio (dB Max)			Hipot (Vrms)
		0.1-100 Mhz	30 Mhz	60 Mhz	80 Mhz	100 Mhz	30 Mhz	60 Mhz	100 Mhz	30 Mhz	60 Mhz	100 Mhz	30 Mhz	60 Mhz	
1000B-5009F	-1.2	-18	-12	-12	-10	-43	-37	-31	-30	-25	-18	-40	-35	-30	1500
1000B-5012F	-1	-18	-12	-12	-10	-43	-37	-33	-43	-37	-33	-43	-37	-33	1500
1000B-5014F	-1.4	-16	-12	-12	-10	-43	-37	-33	-45	-40	-35	-43	-37	-33	1500
1000B-5016F	-1.2	-18	-12	-12	-10	-43	-37	-31	-30	-23	-17	-40	-35	-30	1500

Note: 1. Add suffix X for extended temperature version; i.e. 1000B-5009F becomes 1000B-5009FX. 2. Add suffix NL for RoHS compliant part; i.e. 1000B-5012F becomes 1000B-5012FNL. 3. For Tape & Reel Packaging, add "T" suffix at the end of the part number; i.e. 1000B-5014FT

Mechanicals

1000B-5009F/X

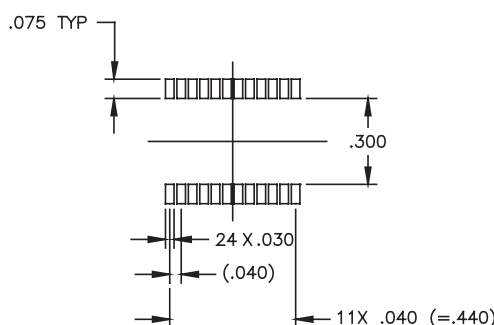
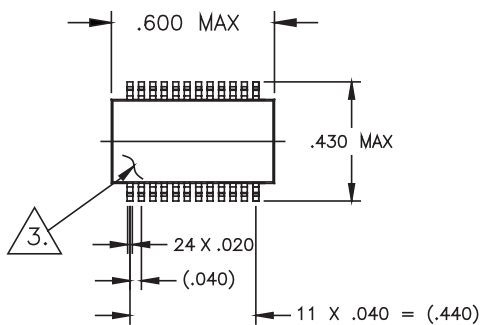

Weight 0.75 grams
 Tape and Reel 250/reel
 Tube 15/tube

Dimensions: $\frac{\text{Inches}}{\text{mm}}$
 Unless otherwise specified, all tolerances are $\pm \frac{.010}{0,25}$

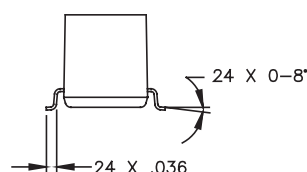
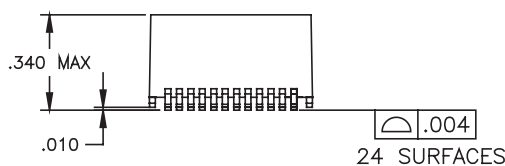

10/100/1000BASE-T SINGLE & DUAL-PORT TRANSFORMER MODULES

Military / Aerospace Grade

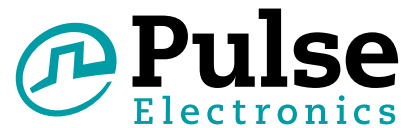

1000B-5012F/X

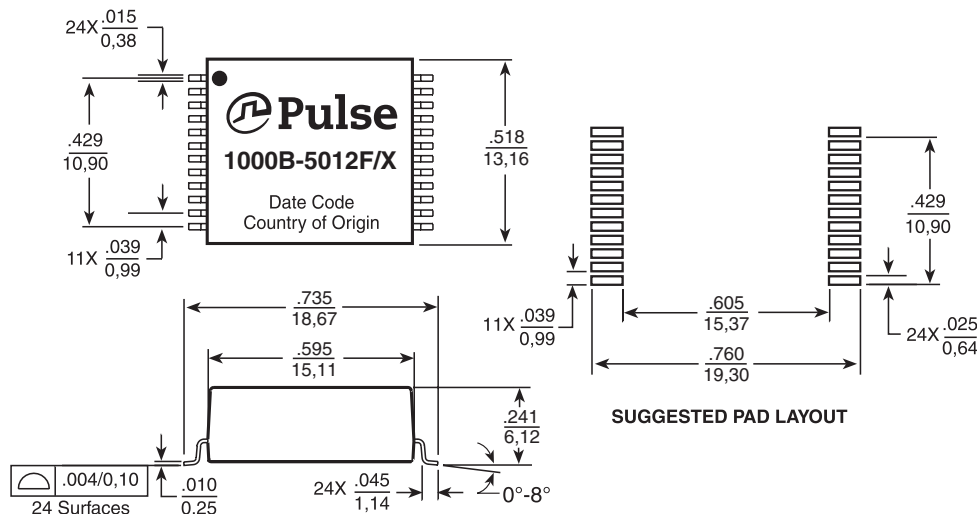

Weight 3.5 grams
Tape and Reel 250/reel
Tube 15/tube

Dimensions: $\frac{\text{Inches}}{\text{mm}}$
Unless otherwise specified,
all tolerances are $\pm \frac{.010}{0,25}$

1000B-5014F/X

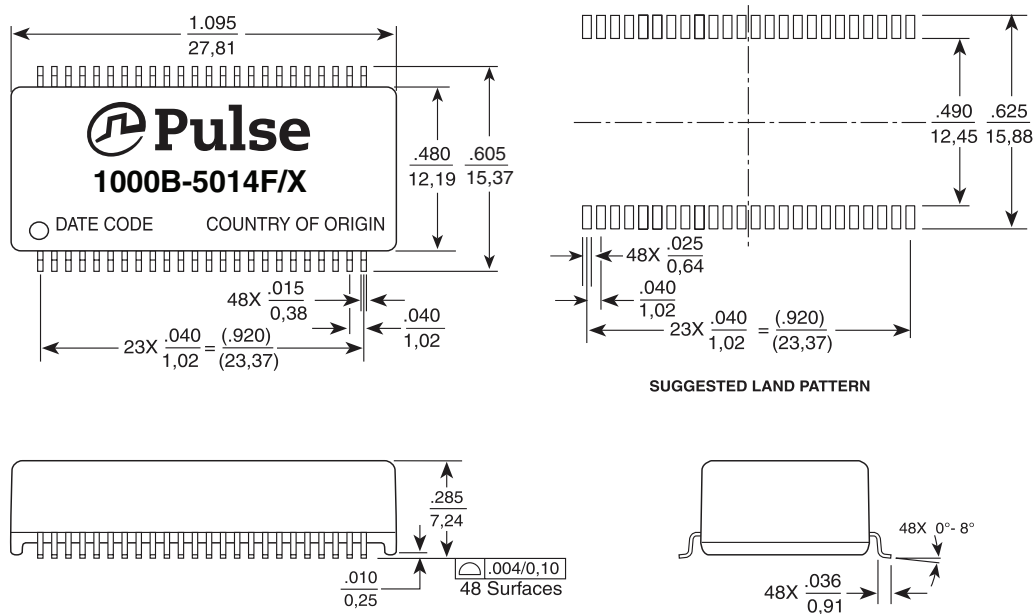

Weight 3.0 grams
Tape and Reel 300/reel
Tube25/tube

Dimensions: $\frac{\text{Inches}}{\text{mm}}$
Unless otherwise specified,
all tolerances are $\pm \frac{.010}{0,25}$

10/100/1000BASE-T SINGLE & DUAL-PORT TRANSFORMER MODULES

Military / Aerospace Grade

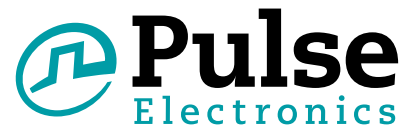

1000B-5016F/X

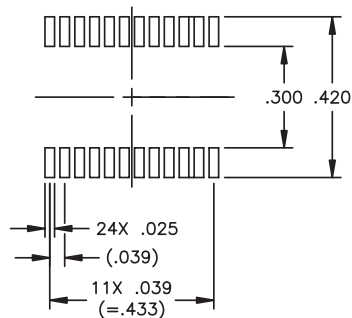
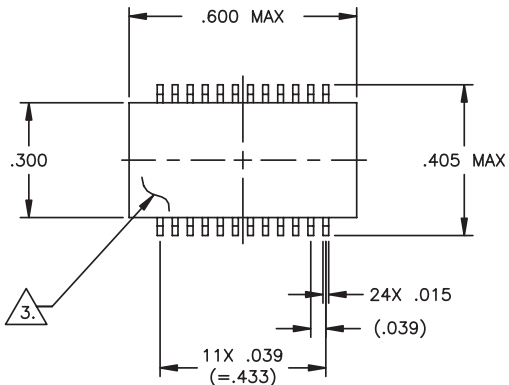

Weight 0.75 grams
 Tape and Reel 700/reel
 Tube30/tube

Dimensions: Inches
 mm
 Unless otherwise specified,
 all tolerances are $\pm \frac{.010}{0.25}$

SUGGESTED LAND PATTERN

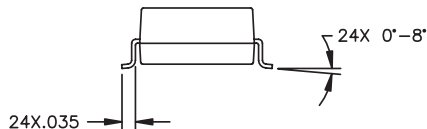
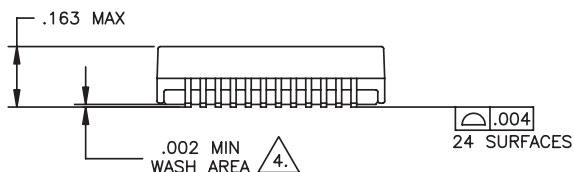

10/100/1000BASE-T SINGLE & DUAL-PORT TRANSFORMER MODULES

Military / Aerospace Grade

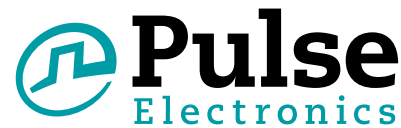

Electrical Schematics

1000B-5009F/X

CHANNEL 1

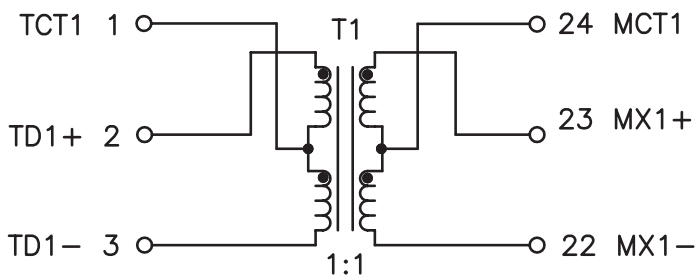

CHANNEL 2

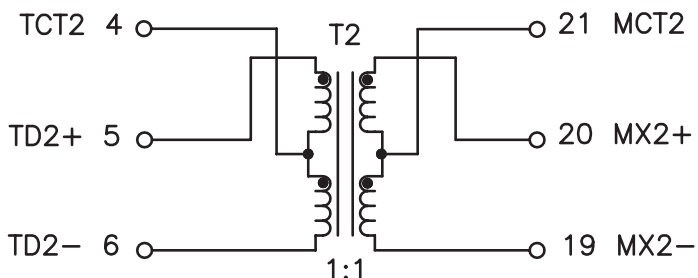

CHANNEL 3

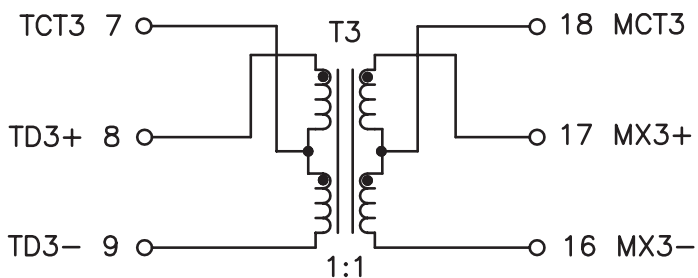

CHANNEL 4

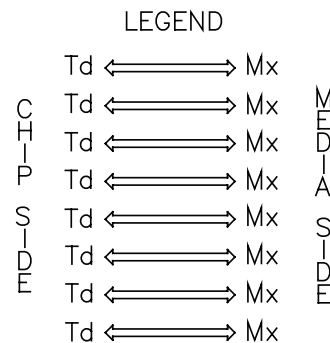
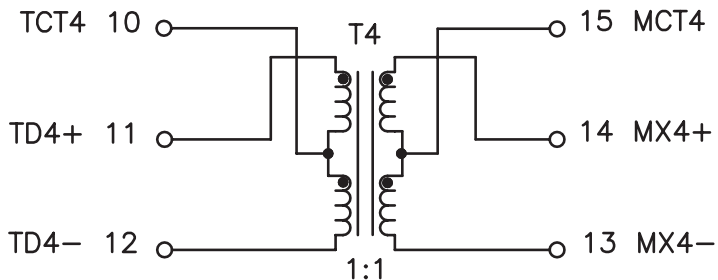

ALL CHANNELS ARE IN PHASE BETWEEN INPUT AND OUTPUT

10/100/1000BASE-T SINGLE & DUAL-PORT TRANSFORMER MODULES

Military / Aerospace Grade



1000B-5012F/X

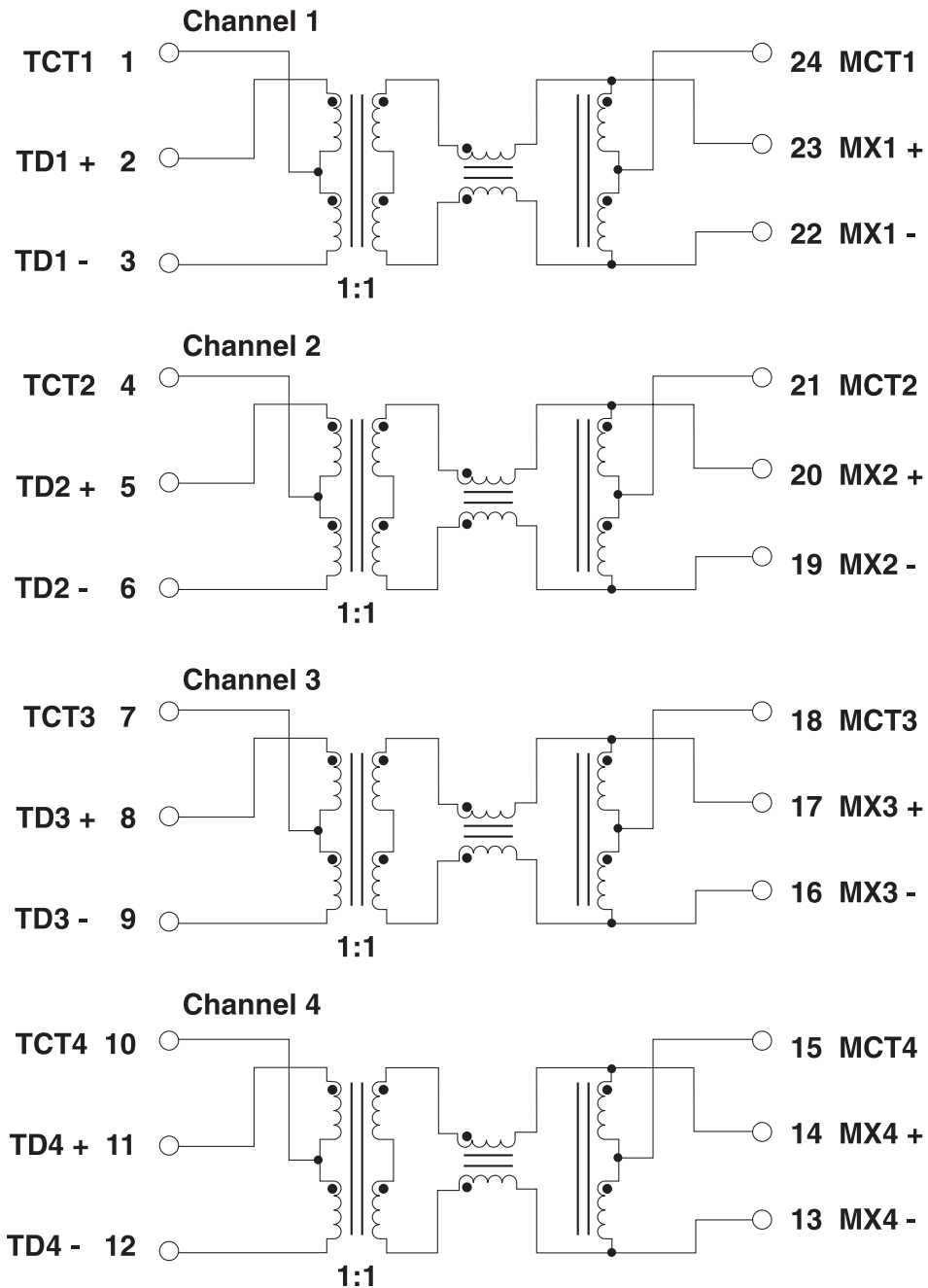

LEGEND

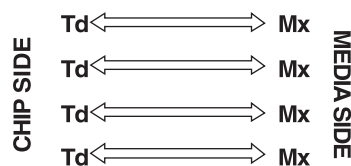

10/100/1000BASE-T SINGLE & DUAL-PORT TRANSFORMER MODULES

Military / Aerospace Grade

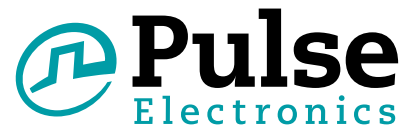

1000B-5014F/X

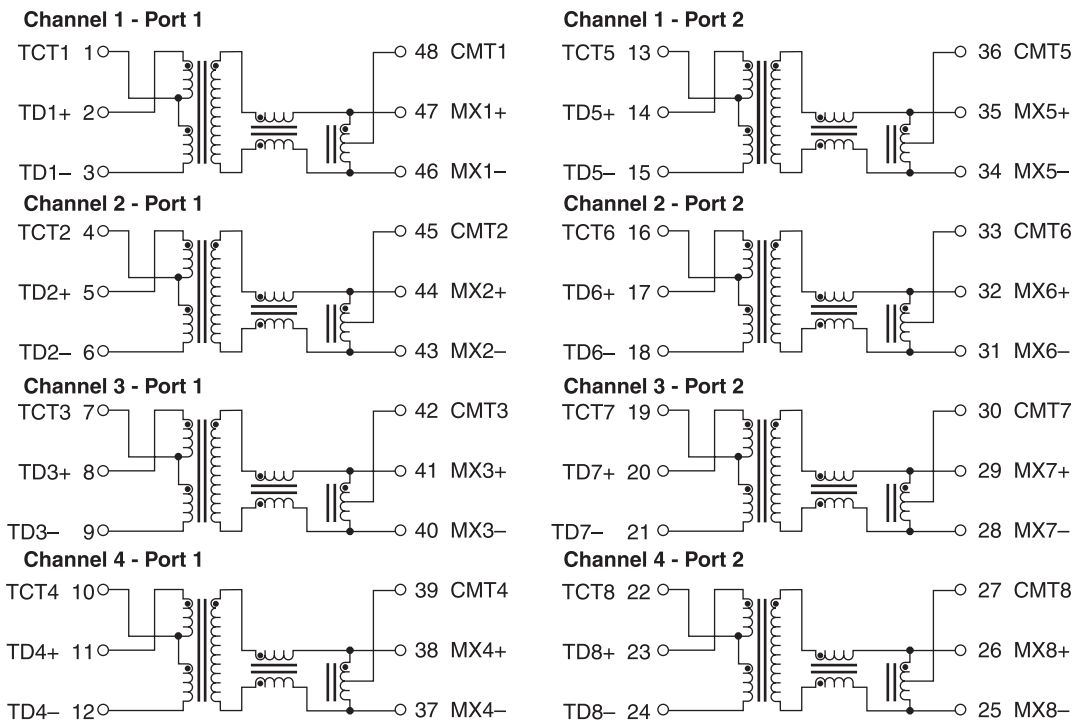

LEGEND

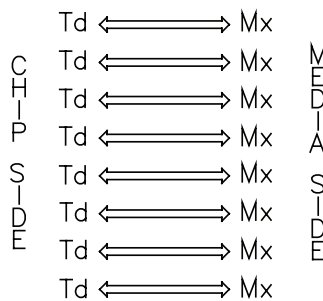

ALL CHANNELS ARE IN PHASE BETWEEN INPUT AND OUTPUT

10/100/1000BASE-T SINGLE & DUAL-PORT TRANSFORMER MODULES

Military / Aerospace Grade

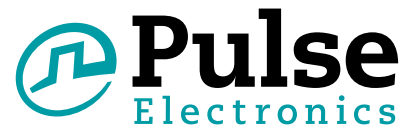

1000B-5016F/X

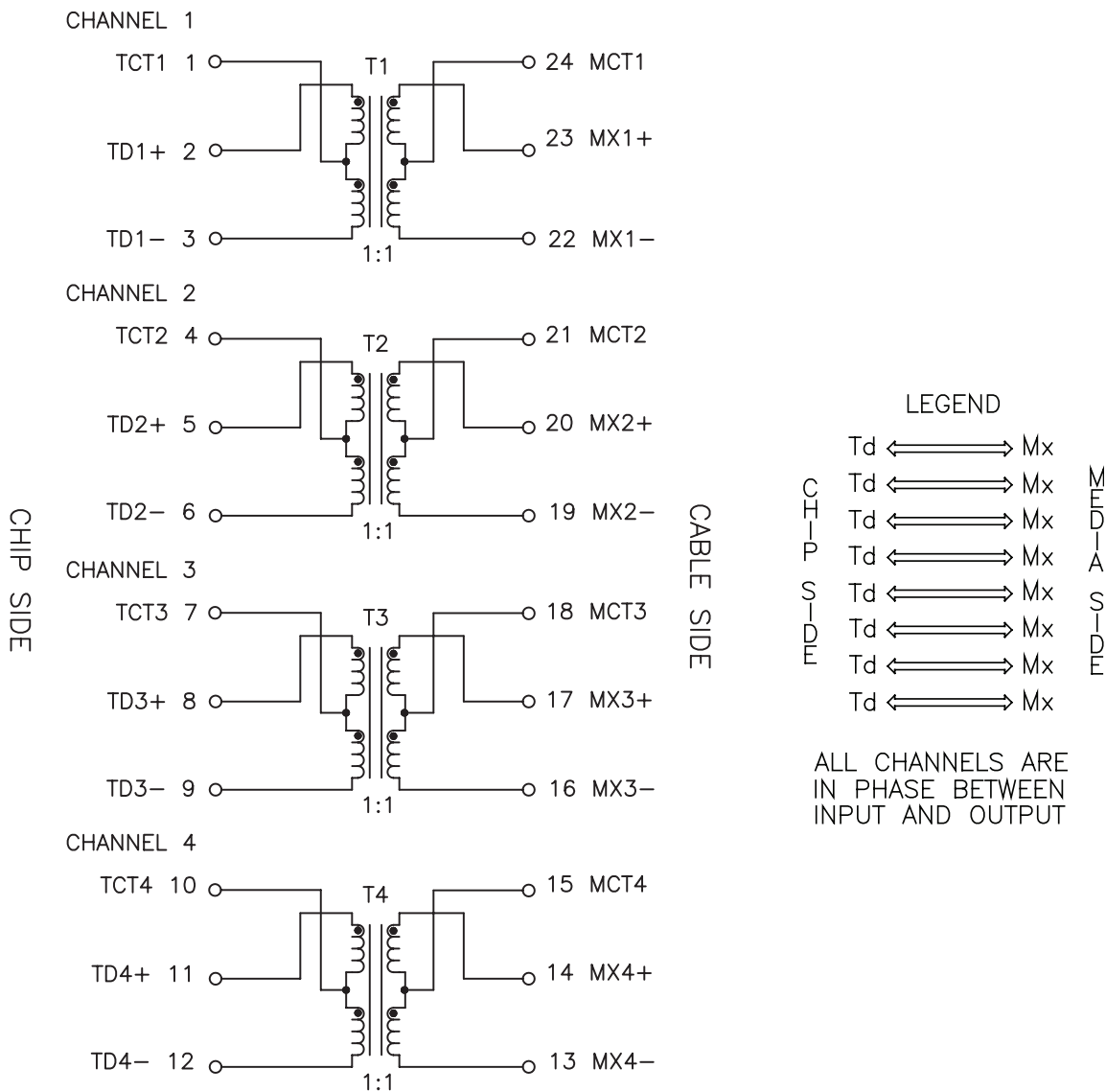

For More Information

Pulse Worldwide Headquarters

Two Pearl Buck Court
Bristol, PA 19007
U.S.A.

Tel: 215 781 6400
Fax: 215 781 6403

Pulse Europe

Einsteinstrasse 1
D-71083 Herrenberg
Germany

Tel: 49 7032 7806 0
Fax: 49 7032 7806 135

Pulse China Headquarters

B402, Shenzhen Academy of
Aerospace Technology Bldg.
10th Kejinan Road
High-Tech Zone
Nanshan District
Shenzhen, PR China 518057

Tel: 86 755 33966678
Fax: 86 755 33966700

Pulse North China

Room 2704/2705
Super Ocean Finance Ctr.
2067 Yan An Road West
Shanghai 200336
China

Tel: 86 21 62787060
Fax: 86 2162786973

Pulse South Asia

135 Joo Seng Road
#03-02
PM Industrial Bldg.
Singapore 368363

Tel: 65 6287 8998
Fax: 65 6287 8998

Pulse North Asia

3F, No. 198
Zhongyuan Road
Zhongli City
Taoyuan County 320
Taiwan R. O. C.

Tel: 886 3 4356768
Fax: 886 3 4356823 (Pulse)
Fax: 886 3 4356820 (FRE)

Performance warranty of products offered on this data sheet is limited to the parameters specified. Data is subject to change without notice. Other brand and product names mentioned herein may be trademarks or registered trademarks of their respective owners. © Copyright, 2012. Pulse Electronics, Inc. All rights reserved.

Данный компонент на территории Российской Федерации

Вы можете приобрести в компании MosChip.

Для оперативного оформления запроса Вам необходимо перейти по данной ссылке:

<http://moschip.ru/get-element>

Вы можете разместить у нас заказ для любого Вашего проекта, будь то серийное производство или разработка единичного прибора.

В нашем ассортименте представлены ведущие мировые производители активных и пассивных электронных компонентов.

Нашей специализацией является поставка электронной компонентной базы двойного назначения, продукции таких производителей как XILINX, Intel (ex.ALTERA), Vicor, Microchip, Texas Instruments, Analog Devices, Mini-Circuits, Amphenol, Glenair.

Сотрудничество с глобальными дистрибьюторами электронных компонентов, предоставляет возможность заказывать и получать с международных складов практически любой перечень компонентов в оптимальные для Вас сроки.

На всех этапах разработки и производства наши партнеры могут получить квалифицированную поддержку опытных инженеров.

Система менеджмента качества компании отвечает требованиям в соответствии с ГОСТ Р ИСО 9001, ГОСТ РВ 0015-002 и ЭС РД 009

Офис по работе с юридическими лицами:

105318, г.Москва, ул.Щербаковская д.3, офис 1107, 1118, ДЦ «Щербаковский»

Телефон: +7 495 668-12-70 (многоканальный)

Факс: +7 495 668-12-70 (доб.304)

E-mail: info@moschip.ru

Skype отдела продаж:

moschip.ru

moschip.ru_4

moschip.ru_6

moschip.ru_9