

# NGTB40N120S3WG

## IGBT - Ultra Field Stop

This Insulated Gate Bipolar Transistor (IGBT) features a robust and cost effective Ultra Field Stop Trench construction, and provides superior performance in demanding switching applications, offering low switching losses. The IGBT is well suited for applications that require fast switching IGBT with low  $V_F$  diodes, e.g. phase-shifted full bridge, etc. Incorporated into the device is a free wheeling diode with a low forward voltage.

### Features

- Extremely Efficient Trench with Field Stop Technology
- $T_{Jmax} = 175^{\circ}C$
- Low  $V_F$  Reverse Diode
- Optimized for High Speed Switching
- These are Pb-Free Devices

### Typical Applications

- Welding
- Uninterruptible Power Inverter Supplies (UPS)
- Motor Control

### ABSOLUTE MAXIMUM RATINGS

| Rating   | Symbol    | Value                | Unit        |
|--|-----------|----------------------|-------------|
| Collector-emitter voltage  | $V_{CES}$ | 1200                 | V           |
| Collector current<br>@ $T_c = 25^{\circ}C$<br>@ $T_c = 100^{\circ}C$                             | $I_C$     | 160<br>40            | A           |
| Pulsed collector current, $T_{pulse}$ limited by $T_{Jmax}$                                      | $I_{CM}$  | 160                  | A           |
| Diode forward current<br>@ $T_c = 25^{\circ}C$<br>@ $T_c = 100^{\circ}C$                         | $I_F$     | 160<br>40            | A           |
| Diode pulsed current, $T_{pulse}$ limited by $T_{Jmax}$  | $I_{FM}$  | 160                  | A           |
| Gate-emitter voltage<br>Transient gate-emitter voltage<br>( $T_{pulse} = 5 \mu s$ , $D < 0.10$ ) | $V_{GE}$  | $\pm 20$<br>$\pm 30$ | V           |
| Power Dissipation<br>@ $T_c = 25^{\circ}C$<br>@ $T_c = 100^{\circ}C$                             | $P_D$     | 454<br>227           | W           |
| Operating junction temperature range   | $T_J$     | -55 to +175          | $^{\circ}C$ |
| Storage temperature range  | $T_{stg}$ | -55 to +175          | $^{\circ}C$ |
| Lead temperature for soldering, 1/8" from case for 10 seconds                                    | $T_{SLD}$ | 260                  | $^{\circ}C$ |

Stresses exceeding those listed in the Maximum Ratings table may damage the device. If any of these limits are exceeded, device functionality should not be assumed, damage may occur and reliability may be affected.



**ON Semiconductor®**

[www.onsemi.com](http://www.onsemi.com)

**40 A, 1200 V**  
 **$V_{CEsat} = 1.7 V$**   
 **$E_{off} = 1.1 mJ$**

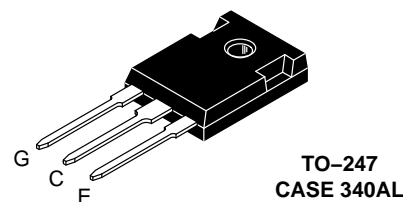
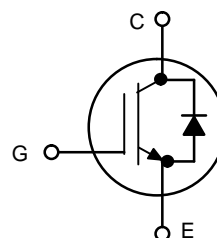

### MARKING DIAGRAM

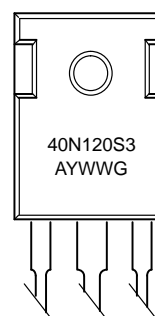

A = Assembly Location  
Y = Year  
WW = Work Week  
G = Pb-Free Package

### ORDERING INFORMATION

| Device         | Package          | Shipping        |
|----------------|------------------|-----------------|
| NGTB40N120S3WG | TO-247 (Pb-Free) | 30 Units / Rail |

# NGTB40N120S3WG

## THERMAL CHARACTERISTICS

| Rating   | Symbol          | Value | Unit                        |
|--|-----------------|-------|-----------------------------|
| Thermal resistance junction-to-case, for IGBT  | $R_{\theta JC}$ | 0.34  | $^{\circ}\text{C}/\text{W}$ |
| Thermal resistance junction-to-case, for Diode | $R_{\theta JC}$ | 0.5   | $^{\circ}\text{C}/\text{W}$ |
| Thermal resistance junction-to-ambient         | $R_{\theta JA}$ | 40    | $^{\circ}\text{C}/\text{W}$ |

## ELECTRICAL CHARACTERISTICS ( $T_J = 25^{\circ}\text{C}$ unless otherwise specified)

| Parameter | Test Conditions | Symbol | Min | Typ | Max | Unit |
|-----------|-----------------|--------|-----|-----|-----|------|
|-----------|-----------------|--------|-----|-----|-----|------|

### STATIC CHARACTERISTIC

|   |   |               |      |            |           |    |
|---|---|---------------|------|------------|-----------|----|
| Collector-emitter breakdown voltage, gate-emitter short-circuited | $V_{GE} = 0\text{ V}, I_C = 500\ \mu\text{A}$   | $V_{(BR)CES}$ | 1200 | –          | –         | V  |
| Collector-emitter saturation voltage                              | $V_{GE} = 15\text{ V}, I_C = 40\text{ A}$<br>$V_{GE} = 15\text{ V}, I_C = 40\text{ A}, T_J = 175^{\circ}\text{C}$         | $V_{CEsat}$   | –    | 1.7<br>2.3 | 1.95<br>– | V  |
| Gate-emitter threshold voltage                                    | $V_{GE} = V_{CE}, I_C = 400\ \mu\text{A}$   | $V_{GE(th)}$  | 4.5  | 5.5        | 6.5       | V  |
| Collector-emitter cut-off current, gate-emitter short-circuited   | $V_{GE} = 0\text{ V}, V_{CE} = 1200\text{ V}$<br>$V_{GE} = 0\text{ V}, V_{CE} = 1200\text{ V}, T_J = 175^{\circ}\text{C}$ | $I_{CES}$     | –    | –<br>0.5   | 0.4<br>–  | mA |
| Gate leakage current, collector-emitter short-circuited           | $V_{GE} = 20\text{ V}, V_{CE} = 0\text{ V}$   | $I_{GES}$     | –    | –          | 200       | nA |

|                              |  |           |   |      |   |    |
|------------------------------|--|-----------|---|------|---|----|
| Input capacitance            | $V_{CE} = 20\text{ V}, V_{GE} = 0\text{ V}, f = 1\text{ MHz}$    | $C_{ies}$ | – | 4912 | – | pF |
| Output capacitance           |  | $C_{oes}$ | – | 140  | – |    |
| Reverse transfer capacitance |  | $C_{res}$ | – | 80   | – |    |
| Gate charge total            | $V_{CE} = 600\text{ V}, I_C = 40\text{ A}, V_{GE} = 15\text{ V}$ | $Q_g$     | – | 212  | – | nC |
| Gate to emitter charge       |  | $Q_{ge}$  | – | 43   | – |    |
| Gate to collector charge     |  | $Q_{gc}$  | – | 102  | – |    |

### SWITCHING CHARACTERISTIC, INDUCTIVE LOAD

|                         |   |              |       |     |     |    |    |
|-------------------------|---|--------------|-------|-----|-----|----|----|
| Turn-on delay time      | $T_J = 25^{\circ}\text{C}$<br>$V_{CC} = 600\text{ V}, I_C = 40\text{ A}$<br>$R_g = 10\ \Omega$<br>$V_{GE} = 15\text{ V}$  | $t_{d(on)}$  | –     | 12  | –   | ns |    |
| Rise time               |   | $t_r$        | –     | 25  | –   |    |    |
| Turn-off delay time     |   | $t_{d(off)}$ | –     | 145 | –   |    |    |
| Fall time               |   |              | $t_f$ | –   | 107 | –  | mJ |
| Turn-on switching loss  |   | $E_{on}$     | –     | 2.2 | –   |    |    |
| Turn-off switching loss |   | $E_{off}$    | –     | 1.1 | –   |    |    |
| Total switching loss    |   | $E_{ts}$     | –     | 3.3 | –   |    |    |
| Turn-on delay time      | $T_J = 175^{\circ}\text{C}$<br>$V_{CC} = 600\text{ V}, I_C = 40\text{ A}$<br>$R_g = 10\ \Omega$<br>$V_{GE} = 15\text{ V}$ | $t_{d(on)}$  | –     | 13  | –   | ns |    |
| Rise time               |   | $t_r$        | –     | 24  | –   |    |    |
| Turn-off delay time     |   | $t_{d(off)}$ | –     | 153 | –   |    |    |
| Fall time               |   |              | $t_f$ | –   | 173 | –  | mJ |
| Turn-on switching loss  |   | $E_{on}$     | –     | 2.8 | –   |    |    |
| Turn-off switching loss |   | $E_{off}$    | –     | 1.6 | –   |    |    |
| Total switching loss    |   | $E_{ts}$     | –     | 4.4 | –   |    |    |

### DIODE CHARACTERISTIC

|  |   |               |   |             |          |                        |
|--|---|---------------|---|-------------|----------|------------------------|
| Forward voltage  | $V_{GE} = 0\text{ V}, I_F = 40\text{ A}$<br>$V_{GE} = 0\text{ V}, I_F = 40\text{ A}, T_J = 175^{\circ}\text{C}$ | $V_F$         | – | 2.0<br>2.55 | 2.6<br>– | V                      |
| Reverse recovery time  | $T_J = 25^{\circ}\text{C}$<br>$I_F = 40\text{ A}, V_R = 400\text{ V}$<br>$di_F/dt = 500\text{ A}/\mu\text{s}$   | $t_{rr}$      | – | 163         | –        | ns                     |
| Reverse recovery charge  |   | $Q_{rr}$      | – | 2.9         | –        | $\mu\text{C}$          |
| Reverse recovery current   |   | $I_{rrm}$     | – | 30          | –        | A                      |
| Diode peak rate of fall of reverse recovery current during $t_b$ |   | $di_{rrm}/dt$ | – | 137         | –        | $\text{A}/\mu\text{s}$ |

# NGTB40N120S3WG

## ELECTRICAL CHARACTERISTICS ( $T_J = 25^\circ\text{C}$ unless otherwise specified)

| Parameter  | Test Conditions   | Symbol        | Min | Typ | Max | Unit                   |
|--|---|---------------|-----|-----|-----|------------------------|
| <b>DIODE CHARACTERISTIC</b>                                      |   |               |     |     |     |                        |
| Reverse recovery time  | $T_J = 175^\circ\text{C}$<br>$I_F = 40\text{ A}$ , $V_R = 400\text{ V}$<br>$di_F/dt = 500\text{ A}/\mu\text{s}$ | $t_{rr}$      | –   | 250 | –   | ns                     |
| Reverse recovery charge  |   | $Q_{rr}$      | –   | 5.3 | –   | $\mu\text{C}$          |
| Reverse recovery current   |   | $I_{rrm}$     | –   | 40  | –   | A                      |
| Diode peak rate of fall of reverse recovery current during $t_b$ |   | $di_{rrm}/dt$ | –   | 482 | –   | $\text{A}/\mu\text{s}$ |

Product parametric performance is indicated in the Electrical Characteristics for the listed test conditions, unless otherwise noted. Product performance may not be indicated by the Electrical Characteristics if operated under different conditions.

# NGTB40N120S3WG

## TYPICAL CHARACTERISTICS

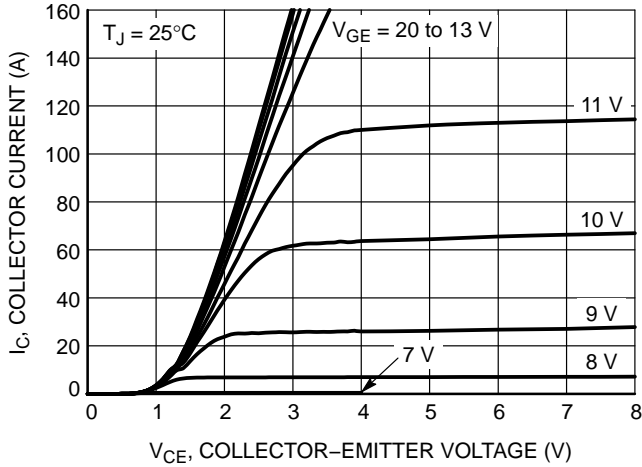

Figure 1. Output Characteristics

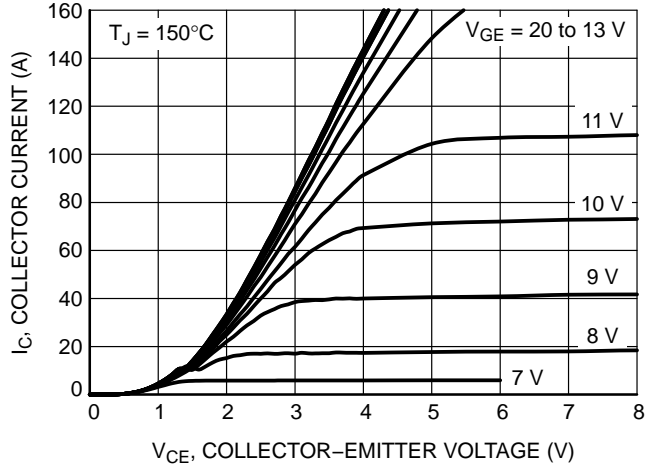

Figure 2. Output Characteristics

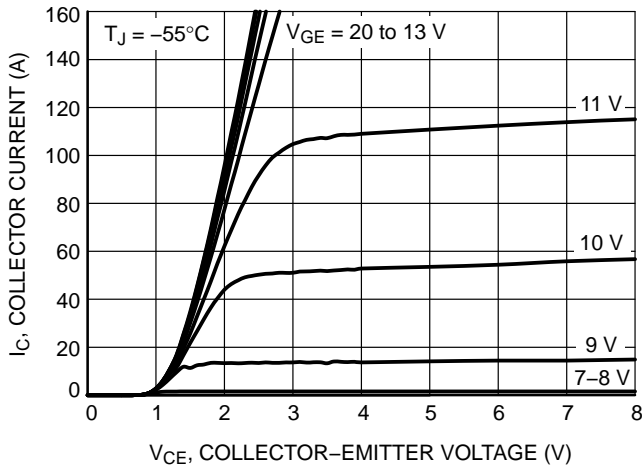

Figure 3. Output Characteristics

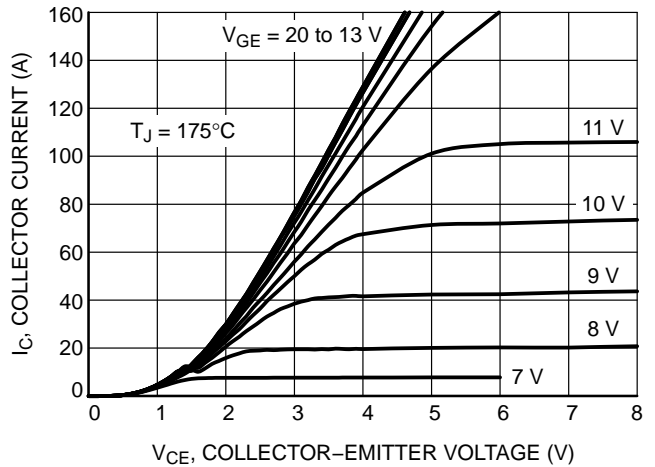

Figure 4. Output Characteristics

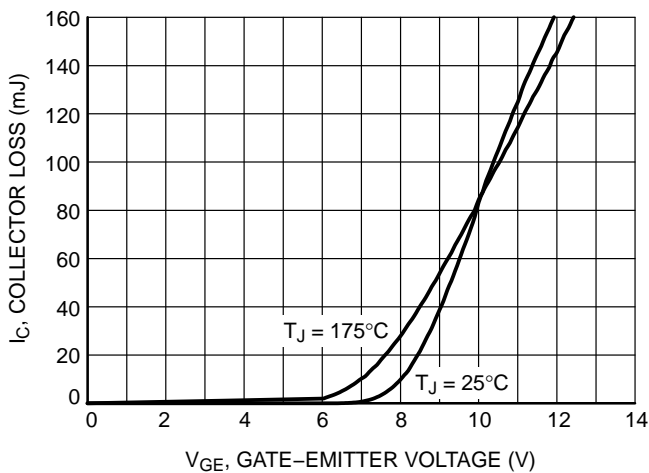

Figure 5. Typical Transfer Characteristics

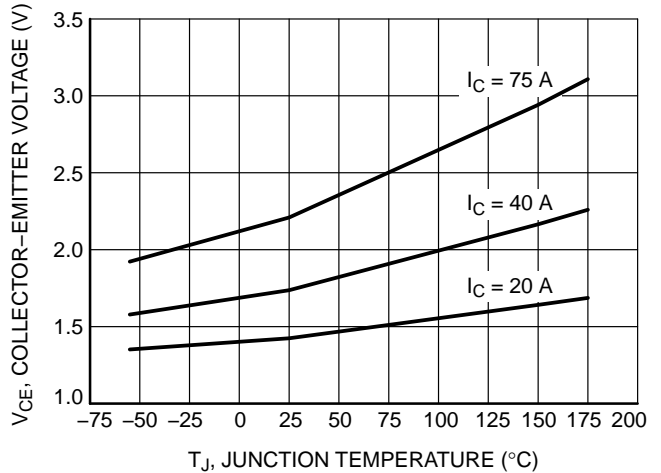

Figure 6.  $V_{CE(sat)}$  vs.  $T_J$

# NGTB40N120S3WG

## TYPICAL CHARACTERISTICS

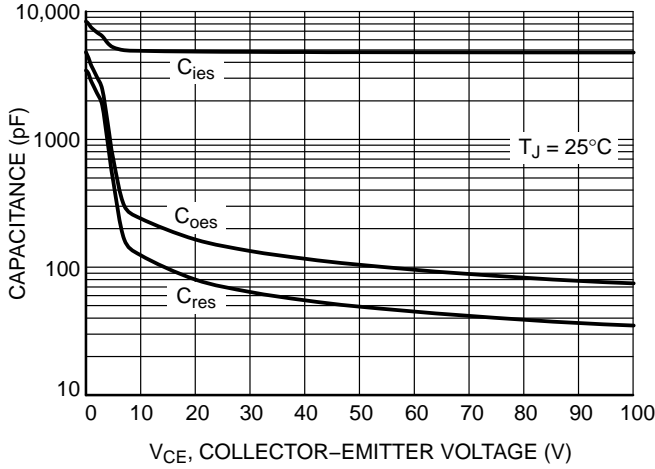

Figure 7. Typical Capacitance

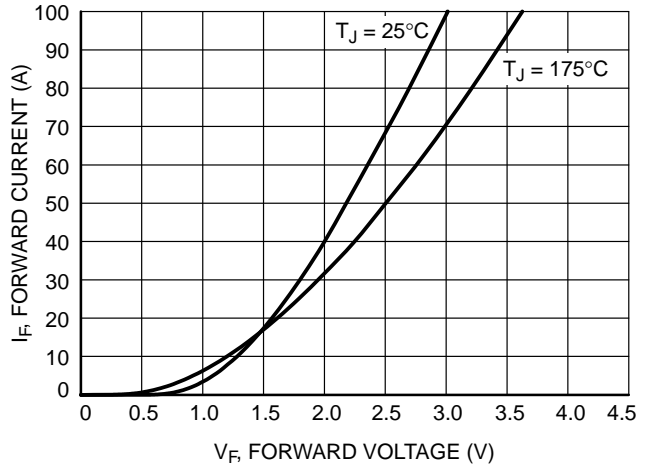

Figure 8. Diode Forward Characteristics

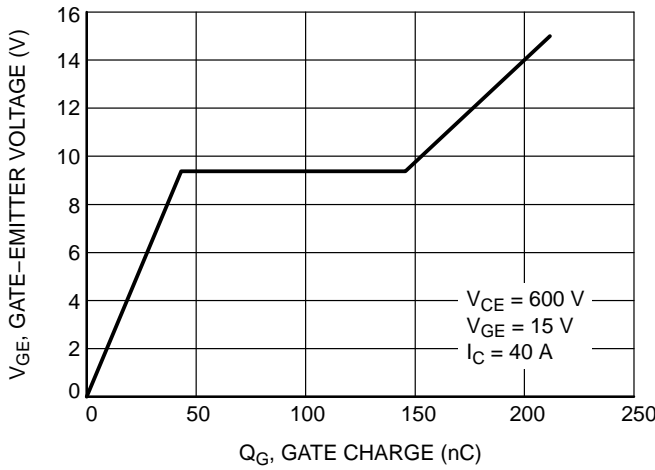

Figure 9. Typical Gate Charge

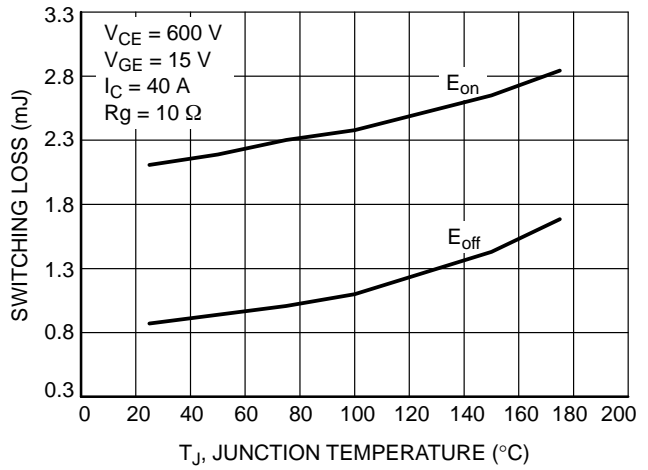

Figure 10. Switching Loss vs. Temperature

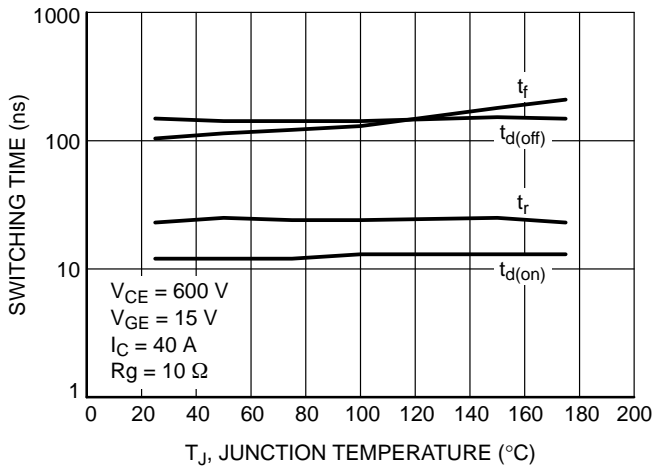

Figure 11. Switching Loss vs. Temperature

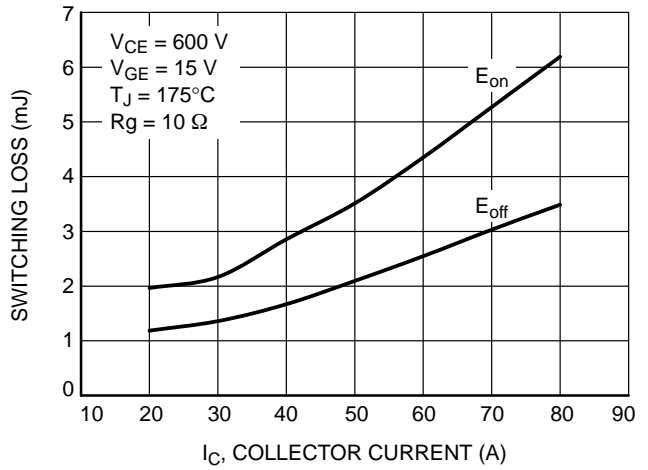

Figure 12. Switching Loss vs. IC

# NGTB40N120S3WG

## TYPICAL CHARACTERISTICS

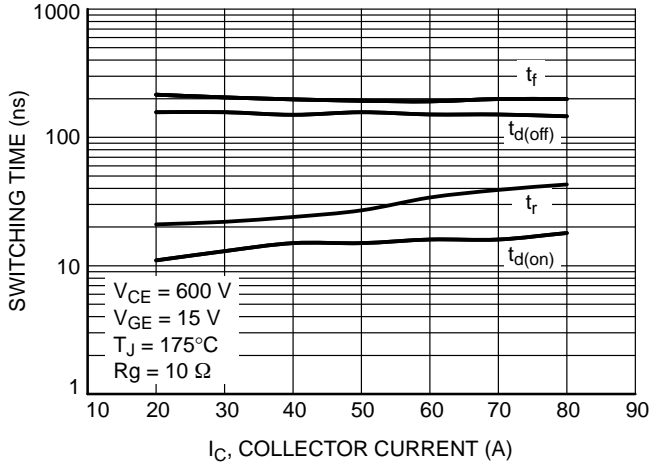

Figure 13. Switching Time vs.  $I_C$

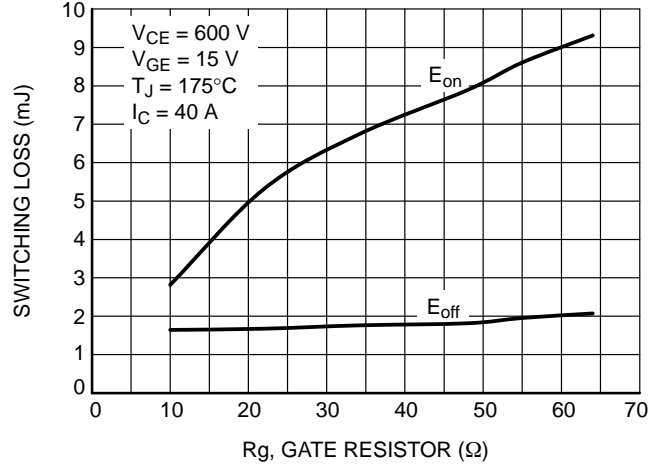

Figure 14. Switching Loss vs.  $R_G$

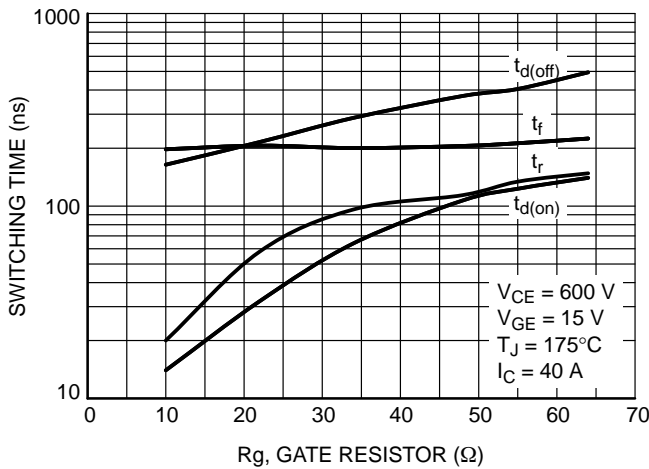

Figure 15. Switching Time vs.  $R_G$

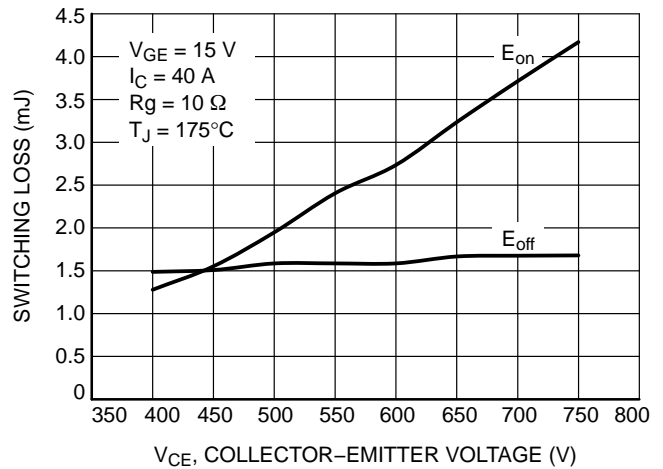

Figure 16. Switching Loss vs.  $V_{CE}$

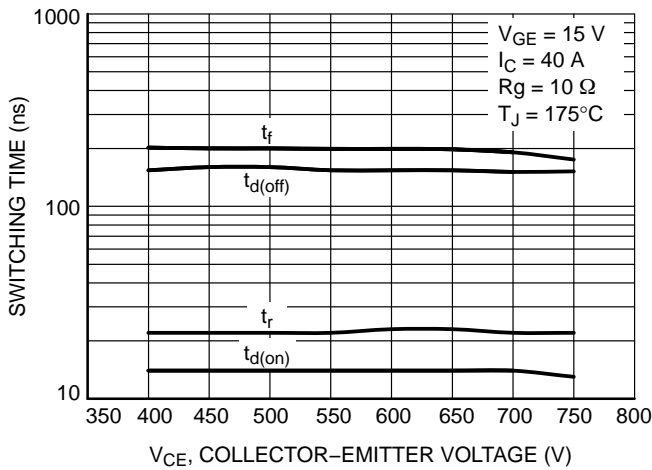

Figure 17. Switching Time vs.  $V_{CE}$

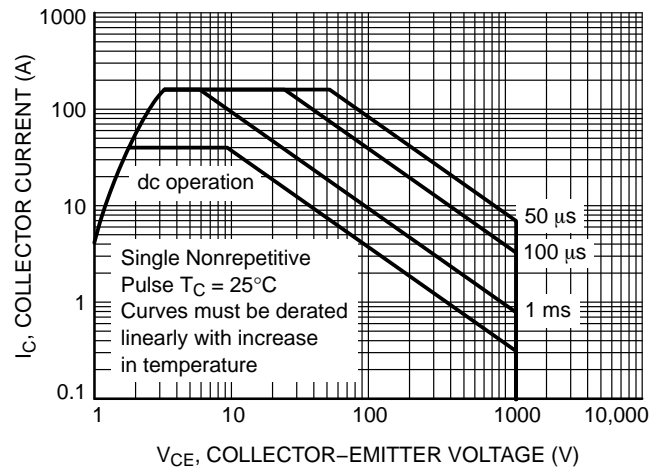

Figure 18. Safe Operating Area

# NGTB40N120S3WG

## TYPICAL CHARACTERISTICS

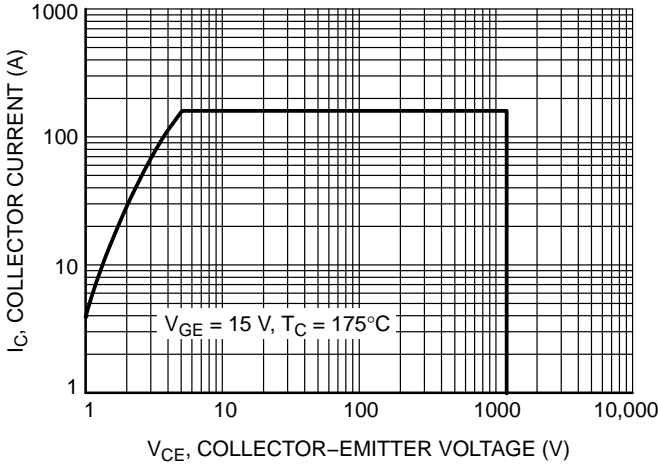

Figure 19. Reverse Bias Safe Operating Area

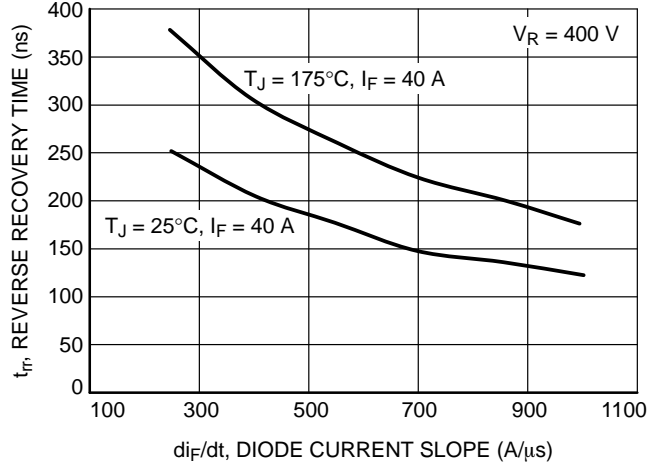

Figure 20.  $t_{rr}$  vs.  $di_F/dt$

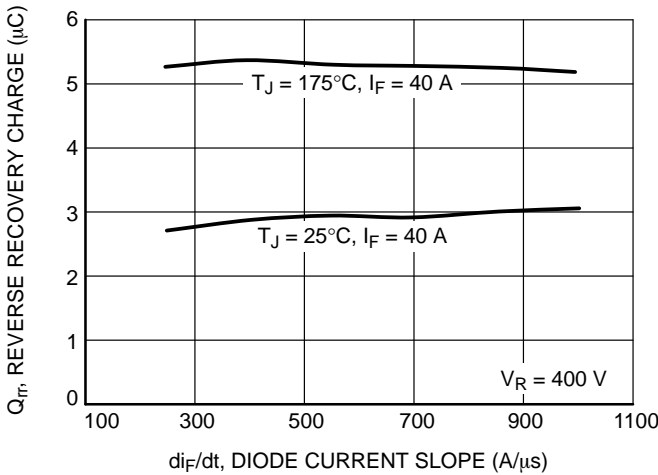

Figure 21.  $Q_{rr}$  vs.  $di_F/dt$

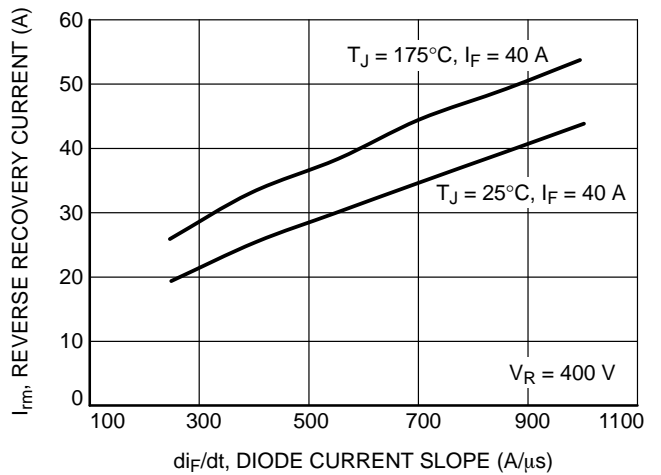

Figure 22.  $I_{rm}$  vs.  $di_F/dt$

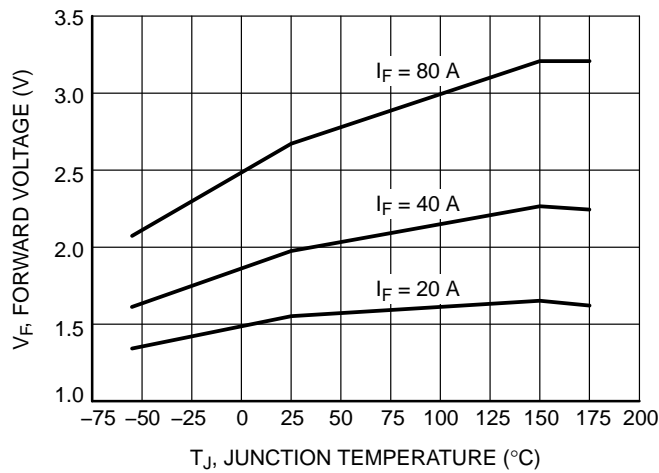

Figure 23.  $V_F$  vs.  $T_J$

# NGTB40N120S3WG

## TYPICAL CHARACTERISTICS

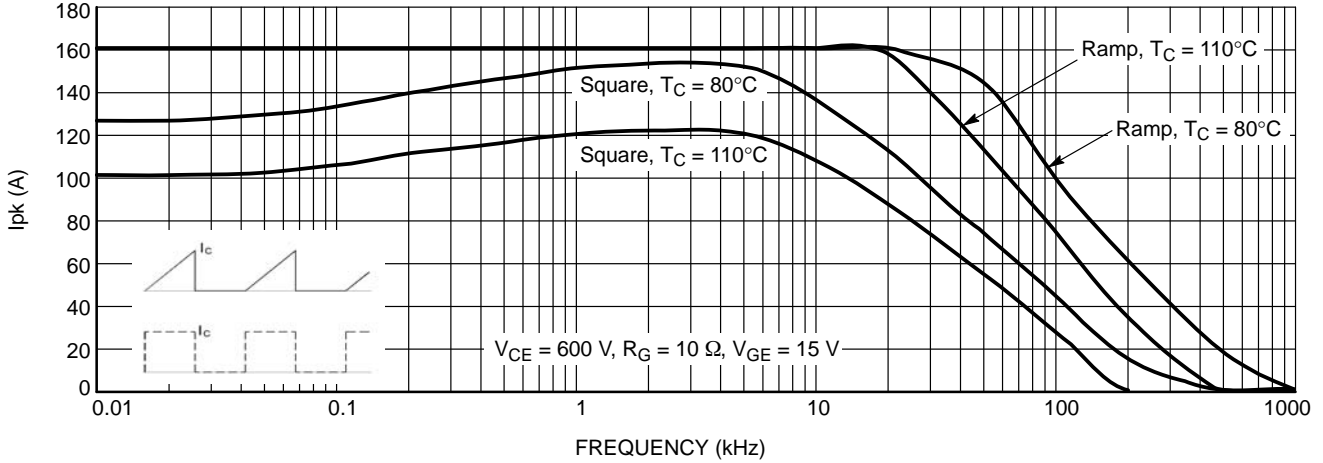

Figure 24. Collector Current vs. Switching Frequency

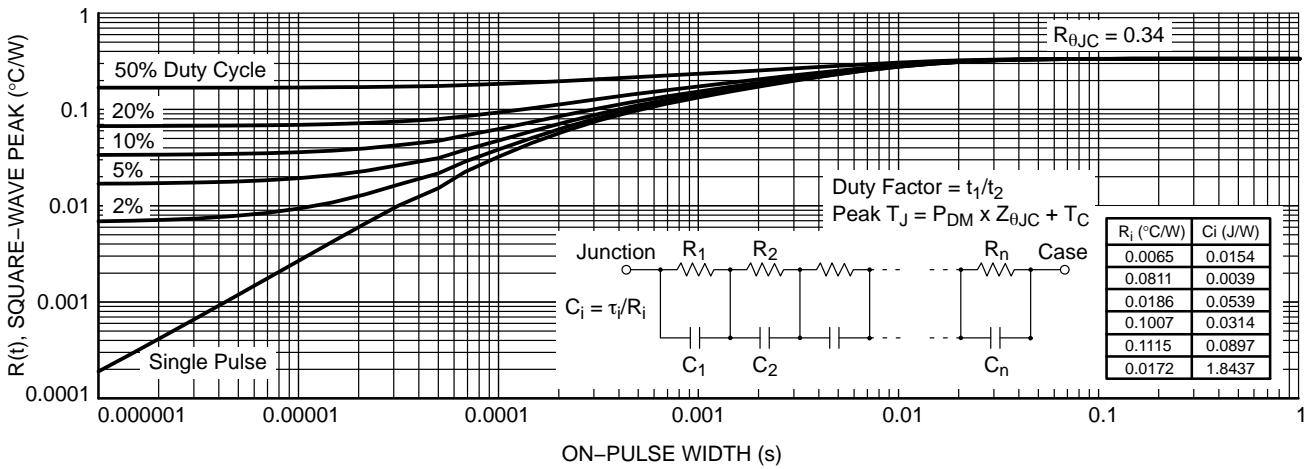

Figure 25. IGBT Transient Thermal Impedance

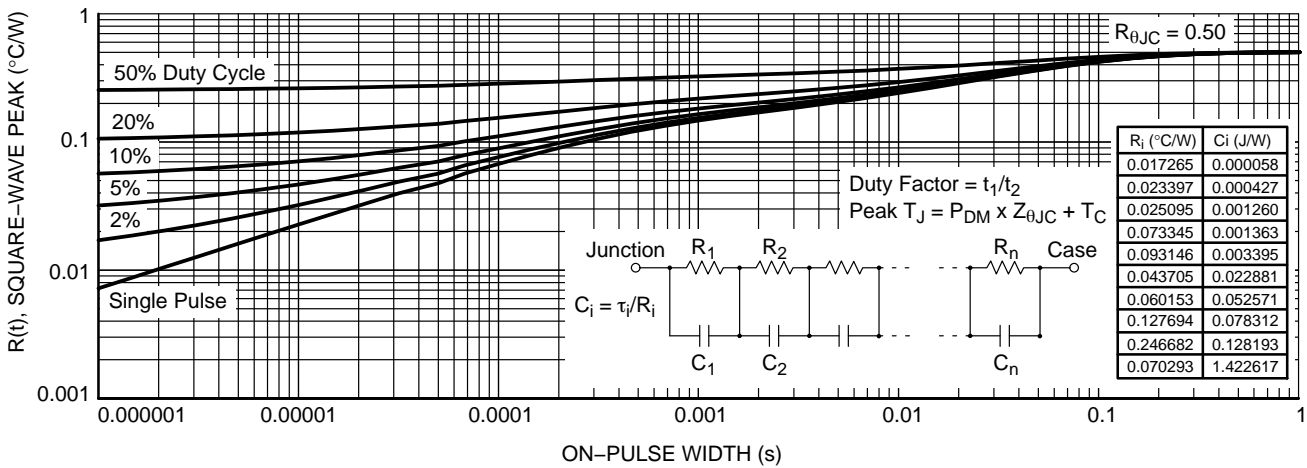

Figure 26. Diode Transient Thermal Impedance



NGTB40N120S3WG

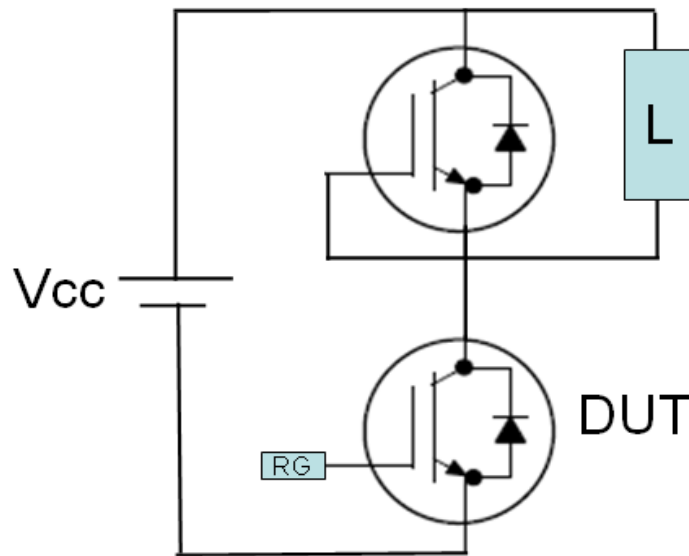

Figure 27. Test Circuit for Switching Characteristics



Figure 28. Definition of Turn On Waveform

NGTB40N120S3WG

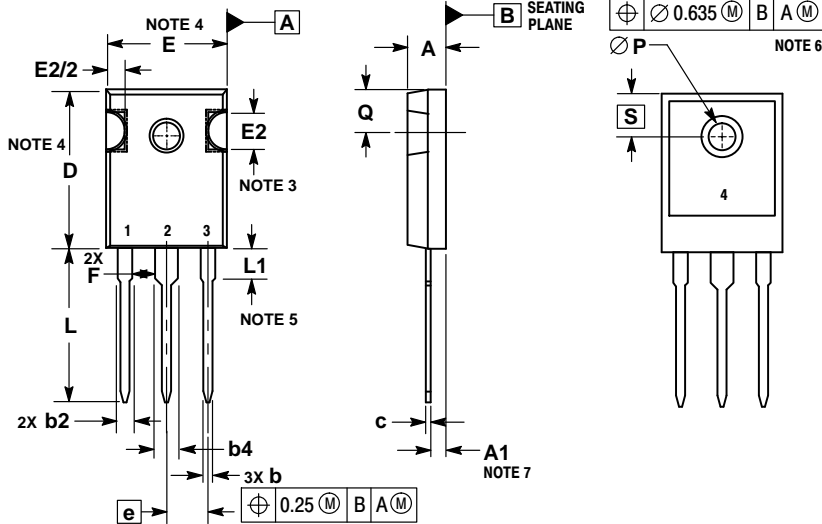

Figure 29. Definition of Turn Off Waveform

# NGTB40N120S3WG

## PACKAGE DIMENSIONS

### TO-247 CASE 340AL ISSUE D



#### NOTES:

1. DIMENSIONING AND TOLERANCING PER ASME Y14.5M, 1994.
2. CONTROLLING DIMENSION: MILLIMETERS.
3. SLOT REQUIRED, NOTCH MAY BE ROUNDED.
4. DIMENSIONS D AND E DO NOT INCLUDE MOLD FLASH. MOLD FLASH SHALL NOT EXCEED 0.13 PER SIDE. THESE DIMENSIONS ARE MEASURED AT THE OUTERMOST EXTREME OF THE PLASTIC BODY.
5. LEAD FINISH IS UNCONTROLLED IN THE REGION DEFINED BY L1.
6.  $\varnothing P$  SHALL HAVE A MAXIMUM DRAFT ANGLE OF 1.5° TO THE TOP OF THE PART WITH A MAXIMUM DIAMETER OF 3.91.
7. DIMENSION A1 TO BE MEASURED IN THE REGION DEFINED BY L1.

| DIM | MILLIMETERS |       |
|-----|-------------|-------|
|     | MIN         | MAX   |
| A   | 4.70        | 5.30  |
| A1  | 2.20        | 2.60  |
| b   | 1.07        | 1.33  |
| b2  | 1.65        | 2.35  |
| b4  | 2.60        | 3.40  |
| c   | 0.45        | 0.68  |
| D   | 20.80       | 21.34 |
| E   | 15.50       | 16.25 |
| E2  | 4.32        | 5.49  |
| e   | 5.45 BSC    |       |
| F   | 2.655       | ---   |
| L   | 19.80       | 20.80 |
| L1  | 3.81        | 4.32  |
| P   | 3.55        | 3.65  |
| Q   | 5.40        | 6.20  |
| S   | 6.15 BSC    |       |

ON Semiconductor and are trademarks of Semiconductor Components Industries, LLC dba ON Semiconductor or its subsidiaries in the United States and/or other countries. ON Semiconductor owns the rights to a number of patents, trademarks, copyrights, trade secrets, and other intellectual property. A listing of ON Semiconductor's product/patent coverage may be accessed at [www.onsemi.com/site/pdf/Patent-Marking.pdf](http://www.onsemi.com/site/pdf/Patent-Marking.pdf). ON Semiconductor reserves the right to make changes without further notice to any products herein. ON Semiconductor makes no warranty, representation or guarantee regarding the suitability of its products for any particular purpose, nor does ON Semiconductor assume any liability arising out of the application or use of any product or circuit, and specifically disclaims any and all liability, including without limitation special, consequential or incidental damages. Buyer is responsible for its products and applications using ON Semiconductor products, including compliance with all laws, regulations and safety requirements or standards, regardless of any support or applications information provided by ON Semiconductor. "Typical" parameters which may be provided in ON Semiconductor data sheets and/or specifications can and do vary in different applications and actual performance may vary over time. All operating parameters, including "Typicals" must be validated for each customer application by customer's technical experts. ON Semiconductor does not convey any license under its patent rights nor the rights of others. ON Semiconductor products are not designed, intended, or authorized for use as a critical component in life support systems or any FDA Class 3 medical devices or medical devices with a same or similar classification in a foreign jurisdiction or any devices intended for implantation in the human body. Should Buyer purchase or use ON Semiconductor products for any such unintended or unauthorized application, Buyer shall indemnify and hold ON Semiconductor and its officers, employees, subsidiaries, affiliates, and distributors harmless against all claims, costs, damages, and expenses, and reasonable attorney fees arising out of, directly or indirectly, any claim of personal injury or death associated with such unintended or unauthorized use, even if such claim alleges that ON Semiconductor was negligent regarding the design or manufacture of the part. ON Semiconductor is an Equal Opportunity/Affirmative Action Employer. This literature is subject to all applicable copyright laws and is not for resale in any manner.

#### PUBLICATION ORDERING INFORMATION

##### LITERATURE FULFILLMENT:

Literature Distribution Center for ON Semiconductor  
19521 E. 32nd Pkwy, Aurora, Colorado 80011 USA  
Phone: 303-675-2175 or 800-344-3860 Toll Free USA/Canada  
Fax: 303-675-2176 or 800-344-3867 Toll Free USA/Canada  
Email: [orderlit@onsemi.com](mailto:orderlit@onsemi.com)

**N. American Technical Support:** 800-282-9855 Toll Free  
USA/Canada  
**Europe, Middle East and Africa Technical Support:**  
Phone: 421 33 790 2910

**ON Semiconductor Website:** [www.onsemi.com](http://www.onsemi.com)

**Order Literature:** <http://www.onsemi.com/orderlit>

For additional information, please contact your local Sales Representative

## Данный компонент на территории Российской Федерации

### Вы можете приобрести в компании MosChip.

Для оперативного оформления запроса Вам необходимо перейти по данной ссылке:

<http://moschip.ru/get-element>

Вы можете разместить у нас заказ для любого Вашего проекта, будь то серийное производство или разработка единичного прибора.

В нашем ассортименте представлены ведущие мировые производители активных и пассивных электронных компонентов.

Нашей специализацией является поставка электронной компонентной базы двойного назначения, продукции таких производителей как XILINX, Intel (ex.ALTERA), Vicor, Microchip, Texas Instruments, Analog Devices, Mini-Circuits, Amphenol, Glenair.

Сотрудничество с глобальными дистрибьюторами электронных компонентов, предоставляет возможность заказывать и получать с международных складов практически любой перечень компонентов в оптимальные для Вас сроки.

На всех этапах разработки и производства наши партнеры могут получить квалифицированную поддержку опытных инженеров.

Система менеджмента качества компании отвечает требованиям в соответствии с ГОСТ Р ИСО 9001, ГОСТ РВ 0015-002 и ЭС РД 009

### Офис по работе с юридическими лицами:

105318, г.Москва, ул.Щербаковская д.3, офис 1107, 1118, ДЦ «Щербаковский»

Телефон: +7 495 668-12-70 (многоканальный)

Факс: +7 495 668-12-70 (доб.304)

E-mail: [info@moschip.ru](mailto:info@moschip.ru)

Skype отдела продаж:

moschip.ru

moschip.ru\_4

moschip.ru\_6

moschip.ru\_9