

## FEATURES

- Rail-to-Rail Input and Output
- $90\mu\text{V}$   $V_{OS(MAX)}$  for  $V_{CM} = V^-$  to  $V^+$
- High Common Mode Rejection Ratio: 97dB Min
- C-Load™ Stable Version (LT1219)
- High  $A_{VOL}$ : 500V/mV Minimum Driving 10k $\Omega$  Load
- Wide Supply Range:
  - 2V to  $\pm 15\text{V}$  (LT1218/LT1219)
  - 2V to  $\pm 5\text{V}$  (LT1218L/LT1219L)
- Shutdown Mode:  $I_S < 30\mu\text{A}$
- Low Supply Current: 420 $\mu\text{A}$  Max
- Low Input Bias Current: 18nA Typical
- 300kHz Gain-Bandwidth Product (LT1218)
- Slew Rate: 0.10V/ $\mu\text{s}$  (LT1218)

## APPLICATIONS

- Driving A/D Converters
- Test Equipment Amplifiers
- MUX Amplifiers

## DESCRIPTION

The LT<sup>®</sup>1218/LT1219 are bipolar op amps which combine rail-to-rail input and output operation with precision specifications. Unlike other rail-to-rail amplifiers, the LT1218/LT1219's input offset voltage is a low  $90\mu\text{V}$  across the entire rail-to-rail input range, not just a portion of it. Using a patented technique, both input stages of the LT1218/LT1219 are trimmed: one at the negative supply and the other at the positive supply. The resulting common mode rejection of 97dB minimum is much better than other rail-to-rail input op amps. A minimum open-loop gain of 500V/mV into a 10k load virtually eliminates all gain error.

The LT1218 has conventional compensation which assures stability for capacitive loads of 1000pF or less. The LT1219 has compensation that requires the use of a 0.1 $\mu\text{F}$  output capacitor, which improves the amplifier's supply rejection and reduces output impedance at high frequencies. The output capacitor's filtering action also reduces high frequency noise, which is beneficial when driving A/D converters.

High and low voltage versions of the devices are offered. Operation is specified for 3V, 5V and  $\pm 5\text{V}$  supplies for the LT1218L/LT1219L and 3V, 5V and  $\pm 15\text{V}$  for the LT1218/LT1219.

LT, LTC and LT are registered trademarks of Linear Technology Corporation.  
 C-Load is a trademark of Linear Technology Corporation.

## TYPICAL APPLICATION



**Voltage Follower Input to Output Error**

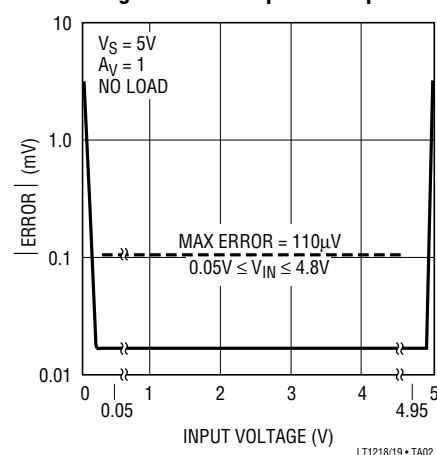

# LT1218/LT1219

## ABSOLUTE MAXIMUM RATINGS

Supply Voltage	
LT1218/LT1219 .....	±18V
LT1218L/LT1219L .....	±8V
Input Current .....	±15mA
Output Short-Circuit Duration (Note 1) .....	Continuous
Operating Temperature Range .....	-40°C to 85°C
Specified Temperature Range (Note 3) ...	-40°C to 85°C
Storage Temperature Range .....	-65°C to 150°C
Junction Temperature .....	150°C
Lead Temperature (Soldering, 10 sec) .....	300°C

## PACKAGE/ORDER INFORMATION

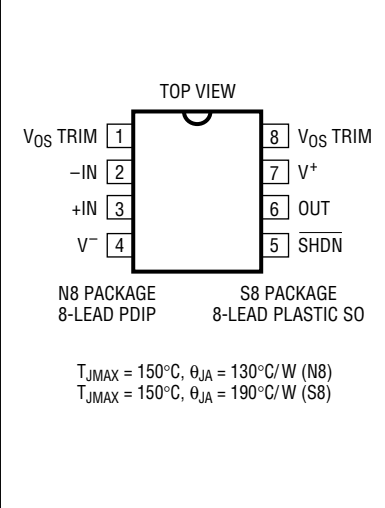
	ORDER PART NUMBER
	LT1218CN8 LT1218CS8 LT1218LCN8 LT1218LCS8 LT1219CN8 LT1219CS8 LT1219LCN8 LT1219LCS8
	S8 PART MARKING
	1218 1219 1218L 1219L

Consult factory for Industrial and Military grades.

## ELECTRICAL CHARACTERISTICS

$T_A = 25^\circ\text{C}$ ,  $V_S = 5\text{V}$ ,  $0\text{V}$ ;  $V_S = 3\text{V}$ ,  $0\text{V}$ ;  $V_{CM} = V_O = \text{half supply}$ ,  $V_{SHDN} = V^+$ , unless otherwise noted.

SYMBOL	PARAMETER	CONDITIONS	MIN	TYP	MAX	UNITS
$V_{OS}$	Input Offset Voltage	$V_{CM} = V^+$ $V_{CM} = V^-$		25 25	90 90	$\mu\text{V}$ $\mu\text{V}$
$\Delta V_{OS}$	Input Offset Voltage Shift	$V_{CM} = V^-$ to $V^+$		15	70	$\mu\text{V}$
$I_B$	Input Bias Current	$V_{CM} = V^+$ $V_{CM} = V^-$	-70	30 -18	70	nA nA
$\Delta I_B$	Input Bias Current Shift	$V_{CM} = V^-$ to $V^+$		50	140	nA
$I_{OS}$	Input Offset Current	$V_{CM} = V^+$ $V_{CM} = V^-$		5 2	18 18	nA nA
$\Delta I_{OS}$	Input Offset Current Shift	$V_{CM} = V^-$ to $V^+$		5	18	nA
$e_n$	Input Noise Voltage Density	$f = 1\text{kHz}$		33		$\text{nV}/\sqrt{\text{Hz}}$
$i_n$	Input Noise Current Density	$f = 1\text{kHz}$		0.09		$\text{pA}/\sqrt{\text{Hz}}$
$A_{VOL}$	Large-Signal Voltage Gain	$V_S = 5\text{V}$ , $V_O = 50\text{mV}$ to $4.8\text{V}$ , $R_L = 10\text{k}$ $V_S = 3\text{V}$ , $V_O = 50\text{mV}$ to $2.8\text{V}$ , $R_L = 10\text{k}$	250 200	1000 750		$\text{V}/\text{mV}$ $\text{V}/\text{mV}$
CMRR	Common Mode Rejection Ratio	$V_S = 5\text{V}$ , $V_{CM} = V^-$ to $V^+$ $V_S = 3\text{V}$ , $V_{CM} = V^-$ to $V^+$	97 92	110 106		dB dB
PSRR	Power Supply Rejection Ratio	$V_S = 2.3\text{V}$ to $12\text{V}$ , $V_{CM} = 0\text{V}$ , $V_O = 0.5\text{V}$	90	100		dB
$V_{OL}$	Output Voltage Swing LOW	No Load $I_{SINK} = 0.5\text{mA}$ $I_{SINK} = 2.5\text{mA}$		4 45 120	12 90 240	mV mV mV
$V_{OH}$	Output Voltage Swing HIGH	No Load $I_{SOURCE} = 0.5\text{mA}$ $I_{SOURCE} = 2.5\text{mA}$	$V^+ - 0.012$ $V^+ - 0.130$ $V^+ - 0.400$	$V^+ - 0.003$ $V^+ - 0.065$ $V^+ - 0.210$		V V V
$I_{SC}$	Short-Circuit Current	$V_S = 5\text{V}$ $V_S = 3\text{V}$	5 4	10 7		mA mA
$I_S$	Supply Current	$V_S = 5\text{V}$ $V_S = 3\text{V}$		370 370	420 410	$\mu\text{A}$ $\mu\text{A}$
	Positive Supply Current, SHDN	$V_S = 5\text{V}$ , $V_{SHDN} = 0\text{V}$ $V_S = 3\text{V}$ , $V_{SHDN} = 0\text{V}$		9 6	30 20	$\mu\text{A}$ $\mu\text{A}$

## ELECTRICAL CHARACTERISTICS

$T_A = 25^\circ\text{C}$ ,  $V_S = 5\text{V}$ ,  $0\text{V}$ ;  $V_S = 3\text{V}$ ,  $0\text{V}$ ;  $V_{CM} = V_0 = \text{half supply}$ ,  $V_{\overline{\text{SHDN}}} = V^+$ , unless otherwise noted.

SYMBOL	PARAMETER	CONDITIONS	MIN	TYP	MAX	UNITS
SR	Slew Rate (LT1218/LT1218L) (LT1219/LT1219L)	$A_V = -1$		0.10		V/ $\mu\text{s}$
		$A_V = -1$		0.05		V/ $\mu\text{s}$
GBW	Gain Bandwidth Product (LT1218/LT1218L) (LT1219/LT1219L)	$A_V = 1000$		0.30		MHz
		$A_V = 1000$		0.15		MHz

$0^\circ\text{C} \leq T_A \leq 70^\circ\text{C}$ ,  $V_S = 5\text{V}$ ,  $0\text{V}$ ;  $V_S = 3\text{V}$ ,  $0\text{V}$ ;  $V_{CM} = V_0 = \text{half supply}$ ,  $V_{\overline{\text{SHDN}}} = V^+$ , unless otherwise noted.

SYMBOL	PARAMETER	CONDITIONS	MIN	TYP	MAX	UNITS
$V_{OS}$	Input Offset Voltage	$V_{CM} = V^+$	●	75	200	$\mu\text{V}$
		$V_{CM} = V^-$	●	75	200	$\mu\text{V}$
$V_{OS\ TC}$	Input Offset Drift	(Note 2)	●	1	3	$\mu\text{V}/^\circ\text{C}$
$\Delta V_{OS}$	Input Offset Voltage Shift	$V_{CM} = V^- \text{ to } V^+$	●	25	80	$\mu\text{V}$
$I_B$	Input Bias Current	$V_{CM} = V^+$	●	30	75	nA
		$V_{CM} = V^-$	●	-75	-18	nA
$\Delta I_B$	Input Bias Current Shift	$V_{CM} = V^- \text{ to } V^+$	●	50	150	nA
$I_{OS}$	Input Offset Current	$V_{CM} = V^+$	●	5	25	nA
		$V_{CM} = V^-$	●	3	25	nA
$\Delta I_{OS}$	Input Offset Current Shift	$V_{CM} = V^- \text{ to } V^+$	●	5	25	nA
$A_{VOL}$	Large-Signal Voltage Gain	$V_S = 5\text{V}$ , $V_0 = 50\text{mV}$ to $4.8\text{V}$ , $R_L = 10\text{k}$	●	250	1000	V/mV
		$V_S = 3\text{V}$ , $V_0 = 50\text{mV}$ to $2.8\text{V}$ , $R_L = 10\text{k}$	●	150	750	V/mV
CMRR	Common Mode Rejection Ratio	$V_S = 5\text{V}$ , $V_{CM} = V^- \text{ to } V^+$	●	96	104	dB
		$V_S = 3\text{V}$ , $V_{CM} = V^- \text{ to } V^+$	●	91	106	dB
PSRR	Power Supply Rejection Ratio	$V_S = 2.3\text{V}$ to $12\text{V}$ , $V_{CM} = 0\text{V}$ , $V_0 = 0.5\text{V}$	●	88	100	dB
$V_{OL}$	Output Voltage Swing LOW	No Load	●	4	14	mV
		$I_{\text{SINK}} = 0.5\text{mA}$	●	45	100	mV
		$I_{\text{SINK}} = 2.5\text{mA}$	●	130	290	mV
$V_{OH}$	Output Voltage Swing HIGH	No Load	●	$V^+ - 0.014$	$V^+ - 0.004$	V
		$I_{\text{SOURCE}} = 0.5\text{mA}$	●	$V^+ - 0.150$	$V^+ - 0.075$	V
		$I_{\text{SOURCE}} = 2.5\text{mA}$	●	$V^+ - 0.480$	$V^+ - 0.240$	V
$I_{SC}$	Short-Circuit Current	$V_S = 5\text{V}$	●	4	7	mA
		$V_S = 3\text{V}$	●	3	6	mA
$I_S$	Supply Current	$V_S = 5\text{V}$	●	370	485	$\mu\text{A}$
		$V_S = 3\text{V}$	●	370	475	$\mu\text{A}$
	Positive Supply Current, SHDN	$V_S = 5\text{V}$ , $V_{\overline{\text{SHDN}}} = 0\text{V}$	●	9	36	$\mu\text{A}$
		$V_S = 3\text{V}$ , $V_{\overline{\text{SHDN}}} = 0\text{V}$	●	6	26	$\mu\text{A}$

$-40^\circ\text{C} \leq T_A \leq 85^\circ\text{C}$ ,  $V_S = 5\text{V}$ ,  $0\text{V}$ ;  $V_S = 3\text{V}$ ,  $0\text{V}$ ;  $V_{CM} = V_0 = \text{half supply}$ ,  $V_{\overline{\text{SHDN}}} = V^+$ , unless otherwise noted. (Note 3)

SYMBOL	PARAMETER	CONDITIONS	MIN	TYP	MAX	UNITS
$V_{OS}$	Input Offset Voltage	$V_{CM} = V^+ - 0.15$	●		400	$\mu\text{V}$
		$V_{CM} = V^- + 0.15$	●		400	$\mu\text{V}$
$V_{OS\ TC}$	Input Offset Drift	(Note 2)	●	1	4	$\mu\text{V}/^\circ\text{C}$
$\Delta V_{OS}$	Input Offset Voltage Shift	$V_{CM} = V^+ - 0.15 \text{ to } V^- + 0.15$	●	30	105	$\mu\text{V}$
$I_B$	Input Bias Current	$V_{CM} = V^+ - 0.15$	●		80	nA
		$V_{CM} = V^- + 0.15$	●	-80		nA
$\Delta I_B$	Input Bias Current Shift	$V_{CM} = V^+ - 0.15 \text{ to } V^- + 0.15$	●		160	nA
$I_{OS}$	Input Offset Current	$V_{CM} = V^+ - 0.15$	●		40	nA
		$V_{CM} = V^- + 0.15$	●		40	nA
$\Delta I_{OS}$	Input Offset Current Shift	$V_{CM} = V^+ - 0.15 \text{ to } V^- + 0.15$	●		40	nA

## ELECTRICAL CHARACTERISTICS

-40°C ≤ T<sub>A</sub> ≤ 85°C, V<sub>S</sub> = 5V, 0V; V<sub>S</sub> = 3V, 0V; V<sub>CM</sub> = V<sub>O</sub> = half supply, V<sub>SHDN</sub> = V<sup>+</sup>, unless otherwise noted. (Note 3)

SYMBOL	PARAMETER	CONDITIONS	MIN	TYP	MAX	UNITS	
A <sub>VOL</sub>	Large-Signal Voltage Gain	V <sub>S</sub> = 5V, V <sub>O</sub> = 50mV to 4.8V, R <sub>L</sub> = 10k	●	150	500	V/mV	
		V <sub>S</sub> = 3V, V <sub>O</sub> = 50mV to 2.8V, R <sub>L</sub> = 10k	●	100	500	V/mV	
CMRR	Common Mode Rejection Ratio	V <sub>S</sub> = 5V, V <sub>CM</sub> = V <sup>+</sup> - 0.15 to V <sup>-</sup> + 0.15	●	93	102	dB	
		V <sub>S</sub> = 3V, V <sub>CM</sub> = V <sup>+</sup> - 0.15 to V <sup>-</sup> + 0.15	●	88	100	dB	
PSRR	Power Supply Rejection Ratio	V <sub>S</sub> = 2.3V to 12V, V <sub>CM</sub> = 0V, V <sub>O</sub> = 0.5V	●	86	100	dB	
V <sub>OL</sub>	Output Voltage Swing LOW	No Load	●		5	15	mV
		I <sub>SINK</sub> = 0.5mA	●		50	105	mV
		I <sub>SINK</sub> = 2.5mA	●		130	300	mV
V <sub>OH</sub>	Output Voltage Swing HIGH	No Load	●	V <sup>+</sup> - 0.015	V <sup>+</sup> - 0.004		mV
		I <sub>SOURCE</sub> = 0.5mA	●	V <sup>+</sup> - 0.160	V <sup>+</sup> - 0.070		mV
		I <sub>SOURCE</sub> = 2.5mA	●	V <sup>+</sup> - 0.500	V <sup>+</sup> - 0.250		mV
I <sub>SC</sub>	Short-Circuit Current	V <sub>S</sub> = 5V	●	4	7	mA	
		V <sub>S</sub> = 3V	●	3	7	mA	
I <sub>S</sub>	Supply Current	V <sub>S</sub> = 5V	●		410	505	μA
		V <sub>S</sub> = 3V	●		400	495	μA
	Positive Supply Current, SHDN	V <sub>S</sub> = 5V, V <sub>SHDN</sub> = 0V	●		15	50	μA
		V <sub>S</sub> = 3V, V <sub>SHDN</sub> = 0V	●		13	40	μA

LT1218L/LT1219L only; T<sub>A</sub> = 25°C, V<sub>S</sub> = ±5V, V<sub>CM</sub> = 0V, V<sub>O</sub> = 0V, V<sub>SHDN</sub> = 5V, unless otherwise noted.

SYMBOL	PARAMETER	CONDITIONS	MIN	TYP	MAX	UNITS
V <sub>OS</sub>	Input Offset Voltage	V <sub>CM</sub> = V <sup>+</sup>		35	140	μV
		V <sub>CM</sub> = V <sup>-</sup>		35	140	μV
ΔV <sub>OS</sub>	Input Offset Voltage Shift	V <sub>CM</sub> = V <sup>-</sup> to V <sup>+</sup>		20	70	μV
I <sub>B</sub>	Input Bias Current	V <sub>CM</sub> = V <sup>+</sup>		30	70	nA
		V <sub>CM</sub> = V <sup>-</sup>	-70	-18		nA
ΔI <sub>B</sub>	Input Bias Current Shift	V <sub>CM</sub> = V <sup>-</sup> to V <sup>+</sup>		50	140	nA
I <sub>OS</sub>	Input Offset Current	V <sub>CM</sub> = V <sup>+</sup>		5	18	nA
		V <sub>CM</sub> = V <sup>-</sup>		2	18	nA
ΔI <sub>OS</sub>	Input Offset Current Shift	V <sub>CM</sub> = V <sup>-</sup> to V <sup>+</sup>		5	18	nA
A <sub>VOL</sub>	Large-Signal Voltage Gain	V <sub>O</sub> = -4.7V to 4.7V, R <sub>L</sub> = 10k		500	2800	V/mV
		V <sub>O</sub> = -4.5V to 4.5V, R <sub>L</sub> = 2k		300	1300	V/mV
CMRR	Common Mode Rejection Ratio	V <sub>CM</sub> = V <sup>-</sup> to V <sup>+</sup>	103	114		dB
V <sub>OL</sub>	Output Voltage Swing LOW	No Load		V <sup>-</sup> + 0.004	V <sup>-</sup> + 0.012	V
		I <sub>SINK</sub> = 0.5mA		V <sup>-</sup> + 0.045	V <sup>-</sup> + 0.090	V
		I <sub>SINK</sub> = 5mA		V <sup>-</sup> + 0.180	V <sup>-</sup> + 0.525	V
V <sub>OH</sub>	Output Voltage Swing HIGH	No Load	V <sup>+</sup> - 0.012	V <sup>+</sup> - 0.003		V
		I <sub>SOURCE</sub> = 0.5mA	V <sup>+</sup> - 0.130	V <sup>+</sup> - 0.065		V
		I <sub>SOURCE</sub> = 5mA	V <sup>+</sup> - 0.800	V <sup>+</sup> - 0.350		V
I <sub>SC</sub>	Short-Circuit Current		6	12	mA	
I <sub>S</sub>	Supply Current			400	430	μA
		Positive Supply Current, SHDN	V <sub>SHDN</sub> = 0V		10	40
SR	Slew Rate (LT1218/LT1218L) (LT1219/LT1219L)	A <sub>V</sub> = -1, R <sub>L</sub> = Open, V <sub>O</sub> = ±3.5V	0.06	0.10		V/μs
		A <sub>V</sub> = -1, R <sub>L</sub> = Open, V <sub>O</sub> = ±3.5V	0.03	0.05		V/μs
GBW	Gain-Bandwidth Product (LT1218/LT1218L) (LT1219/LT1219L)	A <sub>V</sub> = 1000	0.2	0.30		MHz
		A <sub>V</sub> = 1000	0.1	0.15		MHz

## ELECTRICAL CHARACTERISTICS

LT1218L/LT1219L only;  $0^{\circ}\text{C} \leq T_A \leq 70^{\circ}\text{C}$ ,  $V_S = \pm 5\text{V}$ ,  $V_{CM} = 0\text{V}$ ,  $V_O = 0\text{V}$ ,  $V_{\overline{\text{SHDN}}} = 5\text{V}$ , unless otherwise noted.

SYMBOL	PARAMETER	CONDITIONS	MIN	TYP	MAX	UNITS
$V_{OS}$	Input Offset Voltage	$V_{CM} = V^+$	●	100	250	$\mu\text{V}$
		$V_{CM} = V^-$	●	100	250	$\mu\text{V}$
$\Delta V_{OS}$	Input Offset Voltage Shift	$V_{CM} = V^-$ to $V^+$	●	30	90	$\mu\text{V}$
$I_B$	Input Bias Current	$V_{CM} = V^+$	●	30	75	nA
		$V_{CM} = V^-$	●	-75	-18	nA
$\Delta I_B$	Input Bias Current	$V_{CM} = V^-$ to $V^+$	●	50	150	nA
$I_{OS}$	Input Offset Current	$V_{CM} = V^+$	●	5	25	nA
		$V_{CM} = V^-$	●	3	25	nA
$\Delta I_{OS}$	Input Offset Current Shift	$V_{CM} = V^-$ to $V^+$	●	5	20	nA
$A_{VOL}$	Large-Signal Voltage Gain	$V_O = -4.7\text{V}$ to $4.7\text{V}$ , $R_L = 10\text{k}$	●	375	2800	V/mV
		$V_O = -4.5\text{V}$ to $4.5\text{V}$ , $R_L = 2\text{k}$	●	275	1300	V/mV
CMRR	Common Mode Rejection Ratio	$V_{CM} = V^-$ to $V^+$	●	100	110	dB
$V_{OL}$	Output Voltage Swing LOW	No Load	●	$V^- + 0.004$	$V^- + 0.014$	V
		$I_{\text{SINK}} = 0.5\text{mA}$	●	$V^- + 0.045$	$V^- + 0.100$	V
		$I_{\text{SINK}} = 5\text{mA}$	●	$V^- + 0.200$	$V^- + 0.580$	V
$V_{OH}$	Output Voltage Swing HIGH	No Load	●	$V^+ - 0.014$	$V^+ - 0.004$	V
		$I_{\text{SOURCE}} = 0.5\text{mA}$	●	$V^+ - 0.150$	$V^+ - 0.075$	V
		$I_{\text{SOURCE}} = 5\text{mA}$	●	$V^+ - 0.920$	$V^+ - 0.450$	V
$I_{SC}$	Short-Circuit Current		●	5	10	mA
$I_S$	Supply Current		●	400	495	$\mu\text{A}$
	Positive Supply Current, SHDN	$V_{\overline{\text{SHDN}}} = 0\text{V}$	●	11	54	$\mu\text{A}$

LT1218L, LT1219L only;  $-40^{\circ}\text{C} \leq T_A \leq 85^{\circ}\text{C}$ ,  $V_S = \pm 5\text{V}$ ;  $V_{CM} = 0\text{V}$ ,  $V_O = 0\text{V}$ ,  $V_{\overline{\text{SHDN}}} = 5\text{V}$ , unless otherwise noted. (Note 3)

SYMBOL	PARAMETER	CONDITIONS	MIN	TYP	MAX	UNITS
$V_{OS}$	Input Offset Voltage	$V_{CM} = V^+ - 0.15$	●	125	500	$\mu\text{V}$
		$V_{CM} = V^- + 0.15$	●	125	500	$\mu\text{V}$
$\Delta V_{OS}$	Input Offset Voltage Shift	$V_{CM} = V^+ - 0.15$ to $V^- + 0.15$	●	35	120	$\mu\text{V}$
$I_B$	Input Bias Current	$V_{CM} = V^+ - 0.15$	●		80	nA
		$V_{CM} = V^- + 0.15$	●	-80		nA
$\Delta I_B$	Input Bias Current	$V_{CM} = V^+ - 0.15$ to $V^- + 0.15$	●		160	nA
$I_{OS}$	Input Offset Current Shift	$V_{CM} = V^+ - 0.15$	●		40	nA
		$V_{CM} = V^- + 0.15$	●		40	nA
$\Delta I_{OS}$	Input Offset Current Shift	$V_{CM} = V^+ - 0.15$ to $V^- + 0.15$	●		40	nA
$A_{VOL}$	Large-Signal Voltage Gain	$V_O = -4.7\text{V}$ to $4.7\text{V}$ , $R_L = 10\text{k}$	●	300	2000	V/mV
		$V_O = -4.5\text{V}$ to $4.5\text{V}$ , $R_L = 2\text{k}$	●	200	600	V/mV
CMRR	Common Mode Rejection Ratio	$V_{CM} = V^+ - 0.15$ to $V^- + 0.15$	●	98	109	dB
$V_{OL}$	Output Voltage Swing LOW	No Load	●	$V^- + 0.005$	$V^- + 0.015$	V
		$I_{\text{SINK}} = 0.5\text{mA}$	●	$V^- + 0.050$	$V^- + 0.105$	V
		$I_{\text{SINK}} = 2.5\text{mA}$	●	$V^- + 0.200$	$V^- + 0.620$	V
$V_{OH}$	Output Voltage Swing HIGH	No Load	●	$V^+ - 0.015$	$V^+ - 0.004$	V
		$I_{\text{SOURCE}} = 0.5\text{mA}$	●	$V^+ - 0.160$	$V^+ - 0.070$	V
		$I_{\text{SOURCE}} = 2.5\text{mA}$	●	$V^+ - 1.000$	$V^+ - 0.400$	V
$I_{SC}$	Short-Circuit Current		●	5	10	mA
$I_S$	Supply Current		●	420	525	$\mu\text{A}$
	Positive Supply Current, SHDN	$V_{\overline{\text{SHDN}}} = 0\text{V}$	●	18	60	$\mu\text{A}$

## ELECTRICAL CHARACTERISTICS

LT1218/LT1219 only;  $T_A = 25^\circ\text{C}$ ,  $V_S = \pm 15\text{V}$ ,  $V_{CM} = 0\text{V}$ ,  $V_O = 0\text{V}$ ,  $V_{\overline{\text{SHDN}}} = 15\text{V}$ , unless otherwise noted.

SYMBOL	PARAMETER	CONDITIONS	MIN	TYP	MAX	UNITS
$V_{OS}$	Input Offset Voltage	$V_{CM} = V^+$		85	200	$\mu\text{V}$
		$V_{CM} = V^-$		85	200	$\mu\text{V}$
$\Delta V_{OS}$	Input Offset Voltage Shift	$V_{CM} = V^-$ to $V^+$		30	70	$\mu\text{V}$
$I_B$	Input Bias Current	$V_{CM} = V^+$		30	70	nA
		$V_{CM} = V^-$	-70	-18		nA
$\Delta I_B$	Input Bias Current	$V_{CM} = V^-$ to $V^+$		50	140	nA
$I_{OS}$	Input Offset Current	$V_{CM} = V^+$		5	18	nA
		$V_{CM} = V^-$		2	18	nA
$\Delta I_{OS}$	Input Offset Current Shift	$V_{CM} = V^-$ to $V^+$		5	18	nA
$A_{VOL}$	Large-Signal Voltage Gain	$V_O = -14.7\text{V}$ to $14.7\text{V}$ , $R_L = 10\text{k}$	1000	4000		V/mV
		$V_O = -10\text{V}$ to $10\text{V}$ , $R_L = 2\text{k}$	500	2000		V/mV
CMRR	Common Mode Rejection Ratio	$V_{CM} = V^-$ to $V^+$	113	120		dB
PSRR	Power Supply Rejection Ratio	$V_S = \pm 5\text{V}$ to $\pm 15\text{V}$	100	110		dB
$V_{OL}$	Output Voltage Swing LOW	No Load		$V^- + 0.004$	$V^- + 0.012$	V
		$I_{SINK} = 0.5\text{mA}$		$V^- + 0.045$	$V^- + 0.090$	V
		$I_{SINK} = 5\text{mA}$		$V^- + 0.270$	$V^- + 0.525$	V
$V_{OH}$	Output Voltage Swing HIGH	No Load	$V^+ - 0.012$	$V^+ - 0.003$		V
		$I_{SOURCE} = 0.5\text{mA}$	$V^+ - 0.130$	$V^+ - 0.065$		V
		$I_{SOURCE} = 5\text{mA}$	$V^+ - 0.800$	$V^+ - 0.580$		V
$I_{SC}$	Short-Circuit Current		10	20		mA
$I_S$	Supply Current			425	550	$\mu\text{A}$
	Positive Supply Current, SHDN	$V_{\overline{\text{SHDN}}} = 0\text{V}$		15	40	$\mu\text{A}$
SR	Slew Rate (LT1218/LT1218L) (LT1219/LT1219L)	$A_V = -1$		0.10		V/ $\mu\text{s}$
		$A_V = -1$		0.05		V/ $\mu\text{s}$
GBW	Gain Bandwidth Product (LT1218/LT1218L) (LT1219/LT1219L)	$A_V = 1000$		0.28		MHz
		$A_V = 1000$		0.15		MHz

LT1218/LT1219 only;  $0^\circ\text{C} \leq T_A \leq 70^\circ\text{C}$ ,  $V_S = \pm 15\text{V}$ ,  $V_{CM} = 0\text{V}$ ,  $V_O = 0\text{V}$ ,  $V_{\overline{\text{SHDN}}} = 15\text{V}$ , unless otherwise noted.

SYMBOL	PARAMETER	CONDITIONS	MIN	TYP	MAX	UNITS
$V_{OS}$	Input Offset Voltage	$V_{CM} = V^+$	●	120	300	$\mu\text{V}$
		$V_{CM} = V^-$	●	120	300	$\mu\text{V}$
$\Delta V_{OS}$	Input Offset Voltage Shift	$V_{CM} = V^-$ to $V^+$	●	50	105	$\mu\text{V}$
$I_B$	Input Bias Current	$V_{CM} = V^+$	●	30	75	nA
		$V_{CM} = V^-$	●	-75	-18	nA
$\Delta I_B$	Input Bias Current	$V_{CM} = V^-$ to $V^+$	●	50	150	nA
$I_{OS}$	Input Offset Current	$V_{CM} = V^+$	●	5	25	nA
		$V_{CM} = V^-$	●	3	25	nA
$\Delta I_{OS}$	Input Offset Current Shift	$V_{CM} = V^-$ to $V^+$	●	5	20	nA
$A_{VOL}$	Large-Signal Voltage Gain	$V_O = -14.7\text{V}$ to $14.7\text{V}$ , $R_L = 10\text{k}$	●	750	3000	V/mV
		$V_O = -10\text{V}$ to $10\text{V}$ , $R_L = 2\text{k}$	●	500	1500	V/mV
CMRR	Common Mode Rejection Ratio	$V_{CM} = V^-$ to $V^+$	●	109	114	dB
PSRR	Power Supply Rejection Ratio	$V_S = \pm 5\text{V}$ to $\pm 15\text{V}$	●	97	110	dB
$V_{OL}$	Output Voltage Swing LOW	No Load	●	$V^- + 0.004$	$V^- + 0.014$	V
		$I_{SINK} = 0.5\text{mA}$	●	$V^- + 0.045$	$V^- + 0.100$	V
		$I_{SINK} = 5\text{mA}$	●	$V^- + 0.310$	$V^- + 0.580$	V
$V_{OH}$	Output Voltage Swing HIGH	No Load	●	$V^+ - 0.014$	$V^+ - 0.003$	V
		$I_{SOURCE} = 0.5\text{mA}$	●	$V^+ - 0.150$	$V^+ - 0.075$	V
		$I_{SOURCE} = 5\text{mA}$	●	$V^+ - 0.920$	$V^+ - 0.700$	V

## ELECTRICAL CHARACTERISTICS

LT1218/LT1219 only;  $0^{\circ}\text{C} \leq T_A \leq 70^{\circ}\text{C}$ ,  $V_S = \pm 15\text{V}$ ,  $V_{CM} = 0\text{V}$ ,  $V_O = 0\text{V}$ ,  $V_{\overline{\text{SHDN}}} = 15\text{V}$ , unless otherwise noted.

SYMBOL	PARAMETER	CONDITIONS	MIN	TYP	MAX	UNITS
$I_{SC}$	Short-Circuit Current		8	17		mA
$I_S$	Supply Current			450	600	$\mu\text{A}$
	Positive Supply Current, SHDN	$V_{\overline{\text{SHDN}}} = 0\text{V}$		20	54	$\mu\text{A}$

LT1218, LT1219 only;  $-40^{\circ}\text{C} \leq T_A \leq 85^{\circ}\text{C}$ ,  $V_S = \pm 15\text{V}$ ;  $V_{CM} = 0\text{V} = V_O = 0\text{V}$ ,  $V_{\overline{\text{SHDN}}} = 15\text{V}$ , unless otherwise noted. (Note 3)

SYMBOL	PARAMETER	CONDITIONS	MIN	TYP	MAX	UNITS
$V_{OS}$	Input Offset Voltage	$V_{CM} = V^+ - 0.15$ $V_{CM} = V^- + 0.15$		150	600	$\mu\text{V}$ $\mu\text{V}$
$\Delta V_{OS}$	Input Offset Voltage Shift	$V_{CM} = V^+ - 0.15$ to $V^- + 0.15$		50	165	$\mu\text{V}$
$I_B$	Input Bias Current	$V_{CM} = V^+ - 0.15$ $V_{CM} = V^- + 0.15$	-80		80	nA nA
$\Delta I_B$	Input Bias Current	$V_{CM} = V^+ - 0.15$ to $V^- + 0.15$			160	nA
$I_{OS}$	Input Offset Current	$V_{CM} = V^+ - 0.15$ $V_{CM} = V^- + 0.15$			40	nA nA
$\Delta I_{OS}$	Input Offset Current Shift	$V_{CM} = V^+ - 0.15$ to $V^- + 0.15$			40	nA
$A_{VOL}$	Large-Signal Voltage Gain	$V_O = -14.7\text{V}$ to $14.7\text{V}$ , $R_L = 10\text{k}$ $V_O = -10\text{V}$ to $10\text{V}$ , $R_L = 2\text{k}$	500	3000		V/mV V/mV
CMRR	Common Mode Rejection Ratio	$V_{CM} = V^+ - 0.15$ to $V^- + 0.15$	105	114		dB
PSRR	Power Supply Rejection Ratio	$V_S = \pm 5\text{V}$ to $\pm 15\text{V}$	96	110		dB
$V_{OL}$	Output Voltage Swing LOW	No Load $I_{SINK} = 0.5\text{mA}$ $I_{SINK} = 2.5\text{mA}$		$V^- + 0.005$ $V^- + 0.050$ $V^- + 0.200$	$V^- + 0.015$ $V^- + 0.105$ $V^- + 0.620$	V V V
$V_{OH}$	Output Voltage Swing HIGH	No Load $I_{SOURCE} = 0.5\text{mA}$ $I_{SOURCE} = 2.5\text{mA}$	$V^+ - 0.015$ $V^+ - 0.160$ $V^+ - 1.000$	$V^+ - 0.004$ $V^+ - 0.070$ $V^+ - 0.400$		V V V
$I_{SC}$	Short-Circuit Current		5	14		mA
$I_S$	Supply Current				650	$\mu\text{A}$
	Positive Supply Current, SHDN	$V_{\overline{\text{SHDN}}} = 0\text{V}$			60	$\mu\text{A}$

The ● denotes specifications which apply over the full operating temperature range.

**Note 1:** A heat sink may be required to keep the junction temperature below the Absolute Maximum Rating when the output is shorted indefinitely.

**Note 2:** This parameter is not 100% tested.

**Note 3:** The LT1218/LT1219 are designed, characterized and expected to meet these extended temperature limits, but are not tested at  $-40^{\circ}\text{C}$  and  $85^{\circ}\text{C}$ . Guaranteed I grade part are available: consult factory.

TYPICAL PERFORMANCE CHARACTERISTICS

**$V_{OS}$  Distribution,  $V_{CM} = 0V$**

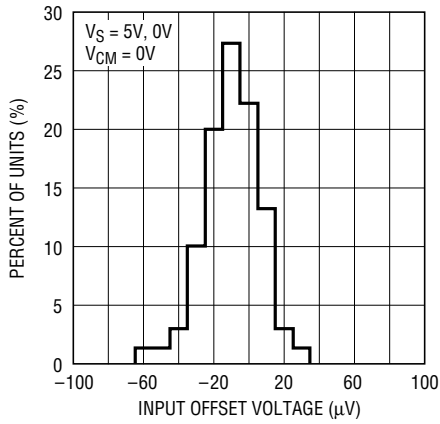

LT1218/19 • TPC01

**$V_{OS}$  Shift,  $V_{CM} = 0V$  to  $5V$**



LT1218/19 • TPC02

**$V_{OS}$  Distribution,  $V_{CM} = 5V$**

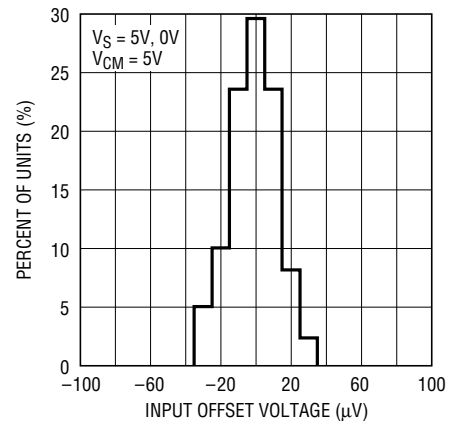

LT1218/19 • TPC03

**Supply Current vs Temperature**

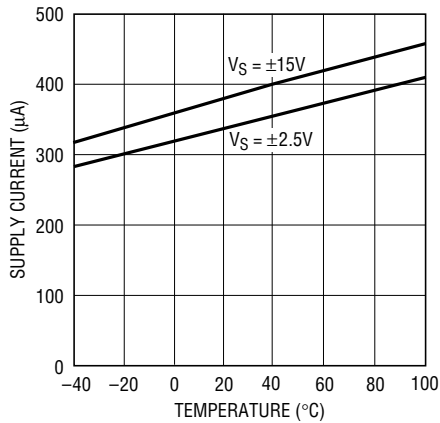

LT1218/19 • TPC04

**Minimum Supply Voltage**

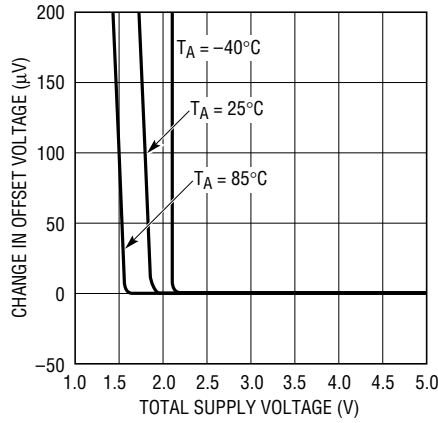

LT1218/19 • TPC05

**Input Bias Current vs Common Mode Voltage**

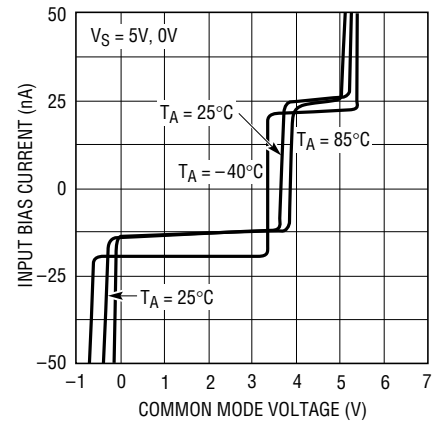

LT1218/19 • TPC06

**Output Saturation Voltage vs Load Current (Output Low)**

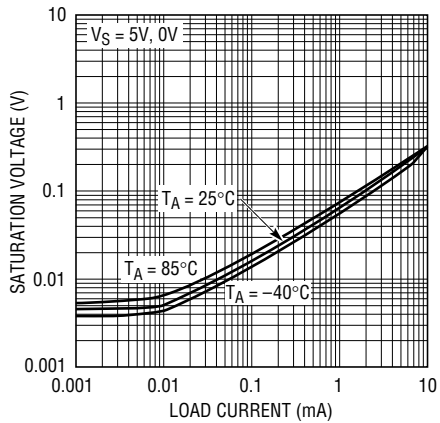

LT1218/19 • TPC07

**Output Saturation Voltage vs Load Current (Output High)**

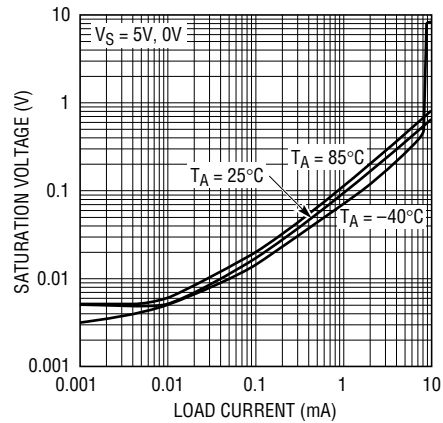

LT1218/19 • TPC08

**0.1Hz to 10Hz Output Voltage Noise**

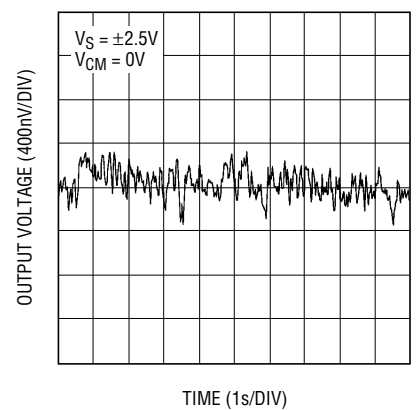

LT1218/19 • TPC09



# TYPICAL PERFORMANCE CHARACTERISTICS

**Noise Voltage Spectrum**

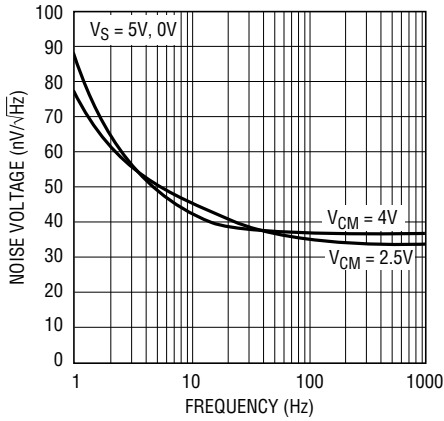

LT1218/19 • TPC10

**Noise Current Spectrum**

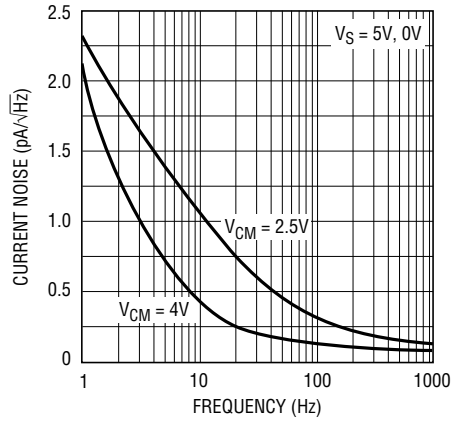

LT1218/19 • TPC11

**LT1218 Gain and Phase Shift vs Frequency**

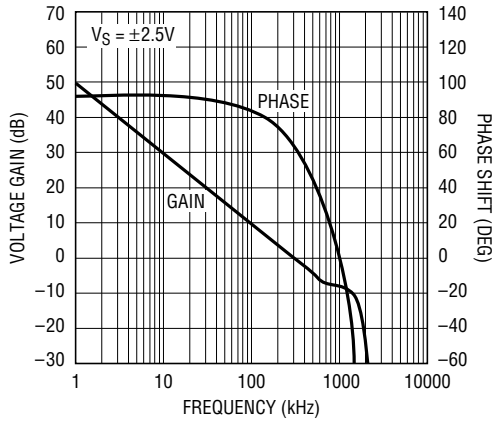

LT1218/19 • TPC12

**LT1219 Gain and Phase Shift vs Frequency**

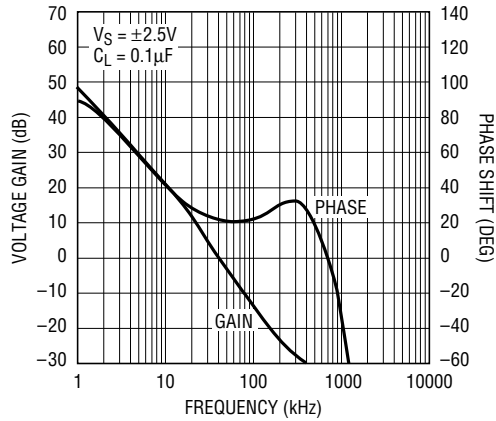

LT1218/19 • TPC13

**LT1218 Gain Bandwidth and Phase Margin vs Supply Voltage**

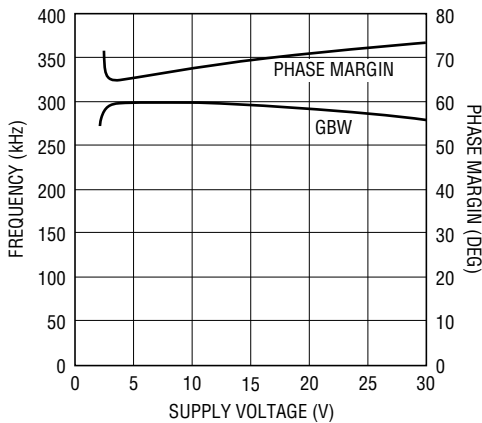

LT1218/19 • TPC

**LT1218 Common Mode Rejection Ratio vs Frequency**

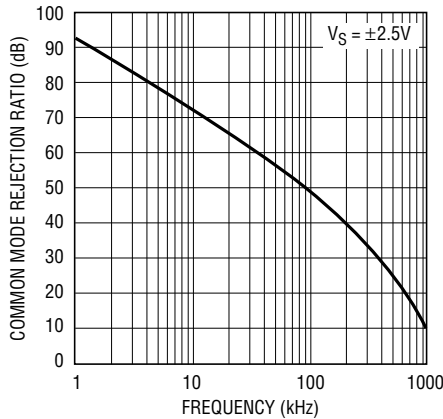

LT1218/19 • TPC15

**LT1219 Power Supply Rejection Ratio vs Frequency**

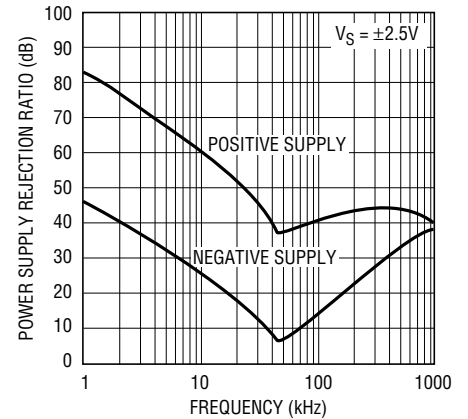

LT1218/19 • TPC16

## TYPICAL PERFORMANCE CHARACTERISTICS

**LT1218 Power Supply Rejection Ratio vs Frequency**

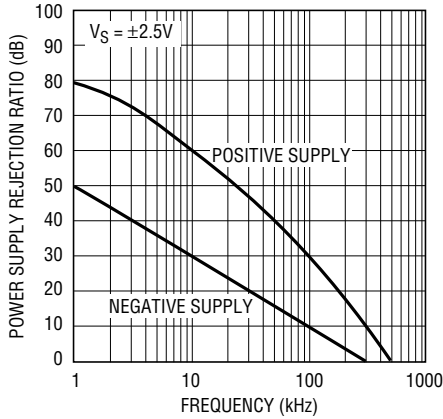

LT1218/19 • TPC17

**LT1218 Closed Loop Output Impedance vs Frequency**

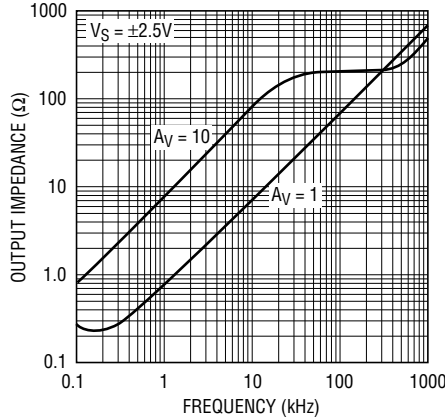

LT1218/19 • TPC18

**LT1219 Closed Loop Output Impedance vs Frequency**

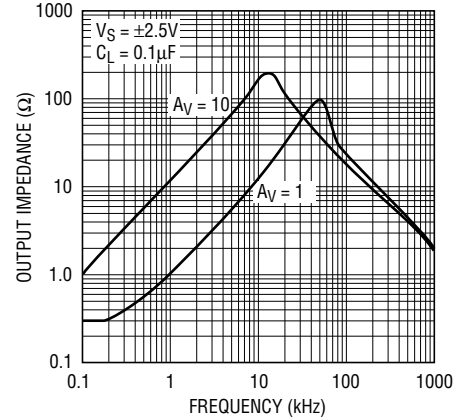

LT1218/19 • TPC19

**LT1218 Capacitive Load Handling**

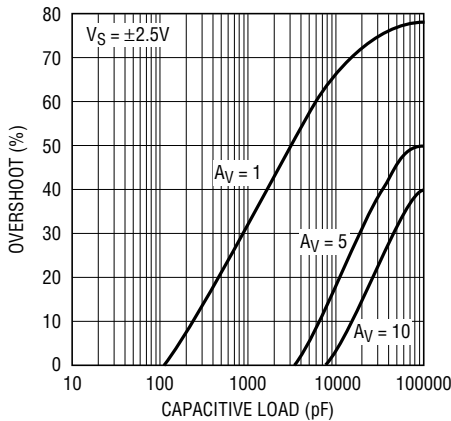

LT1218/19 • TPC20

**LT1219 Overshoot vs Load Current, V\_S = ±2.5V**

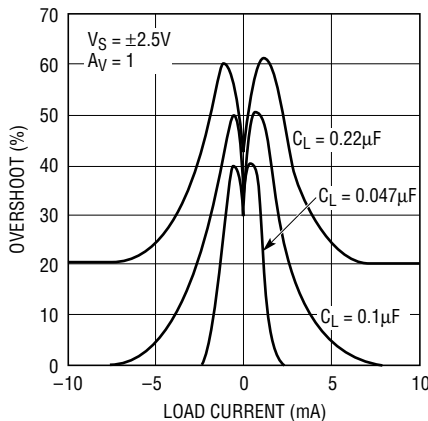

LT1218/19 • TPC21

**LT1219 Overshoot vs Load Current, V\_S = ±15V**

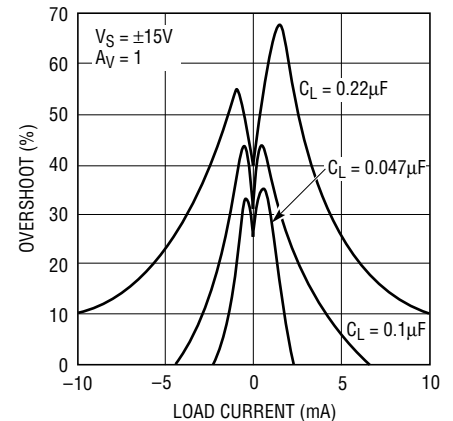

LT1218/19 • TPC22

**Open-Loop Gain, V\_S = ±15V**

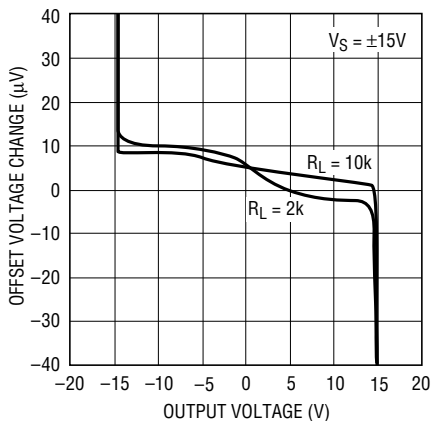

LT1218/19 • TPC23

**Input Offset Drift vs Time**

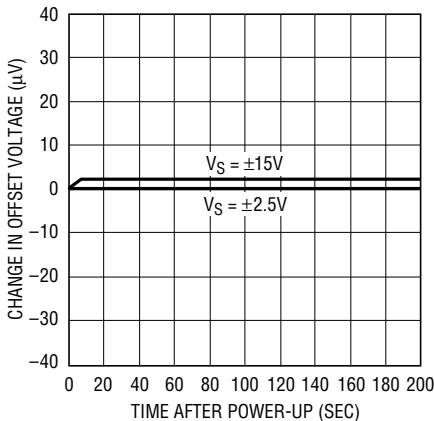

LT1218/19 • TPC24

**THD + Noise vs Frequency**

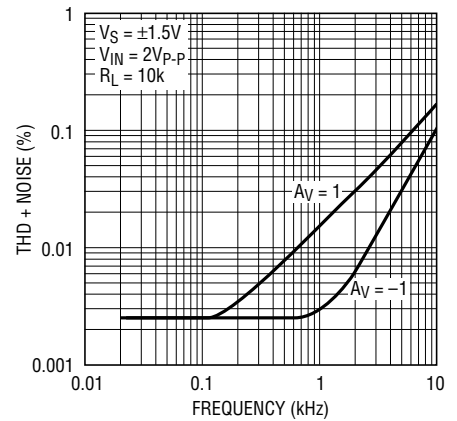

LT1218/19 • TPC25

# TYPICAL PERFORMANCE CHARACTERISTICS

**THD + Noise vs Peak-to-Peak Voltage**

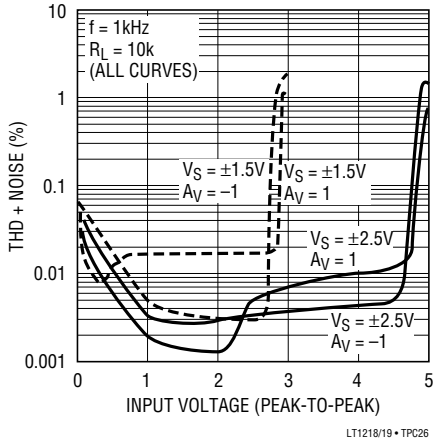

**Small-Signal Response**  
 $V_S = \pm 15V$

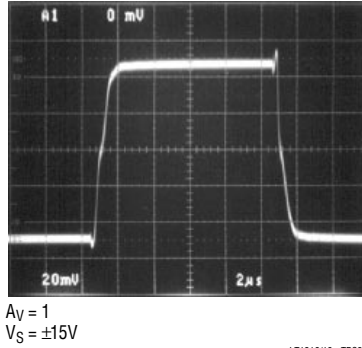

**Large-Signal Response**  
 $V_S = \pm 15V$

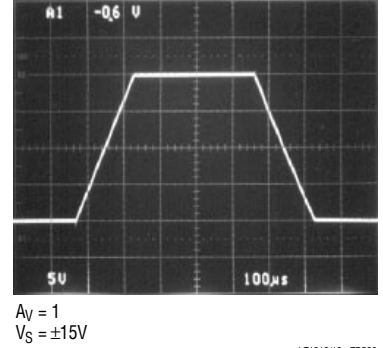

# APPLICATIONS INFORMATION

## Rail-to-Rail Operation

The LT1218/LT1219 differ from conventional op amps in the design of both the input and output stages. Figure 1 shows a simplified schematic of the amplifier. The input stage consists of two differential amplifiers, a PNP stage

Q1/Q2 and an NPN stage Q3/Q4, which are active over different portions of the input common mode range. Lateral devices are used in both input stages, eliminating the need for clamps across the input pins. Each input stage is trimmed for offset voltage. A complementary output configuration (Q23 through Q26) is employed to create an



Figure 1. LT1218 Simplified Schematic Diagram

## APPLICATIONS INFORMATION

output stage with rail-to-rail swing. The amplifier is fabricated on Linear Technology's proprietary complementary bipolar process, which ensures very similar DC and AC characteristics for the output devices Q24 and Q26.

A simple comparator Q5 steers current from current source  $I_1$  between the two input stages. When the input common mode voltage  $V_{CM}$  is near the negative supply, Q5 is reverse biased, and  $I_1$  becomes the tail current for the PNP differential pair Q1/Q2. At the other extreme, when  $V_{CM}$  is within about 1.3V from the positive supply, Q5 diverts  $I_1$  to the current mirror D3/Q6, which furnishes the tail current for the NPN differential pair Q3/Q4.

The collector currents of the two input pairs are combined in the second stage, consisting of Q7 through Q11. Most of the voltage gain in the amplifier is contained in this stage. Differential amplifier Q14/Q15 buffers the output of the second stage, converting the output voltage to differential currents. The differential currents pass through current mirrors D4/Q17 and D5/Q16, and are converted to differential voltages by Q18 and Q19. These voltages are also buffered and applied to the output Darlington pairs Q23/Q24 and Q25/Q26. Capacitors C1 and C2 form local feedback loops around the output devices, lowering the output impedance at high frequencies.

### Input Offset Voltage

Since the amplifier has two input stages, the input offset voltage changes depending upon which stage is active. The input offsets are random, but bounded voltages. When the amplifier switches between stages, offset voltages may go up, down or remain flat; but will not exceed the guaranteed limits. This behavior is illustrated in three distribution plots of input offset voltage in the Typical Performance Characteristics section.

### Overdrive Protection

Two circuits prevent the output from reversing polarity when the input voltage exceeds the common mode range. When the noninverting input exceeds the positive supply by approximately 300mV, the clamp transistor Q12 (Fig-

ure 1) turns on, pulling the output of the second stage low, which forces the output high. For input below the negative supply, diodes D1 and D2 turn on, overcoming the saturation of the input pair Q1/Q2.

When overdriven, the amplifier draws input current that exceeds the normal input bias current. Figures 2 and 3 show typical input current as a function of input voltage. The input current must be less than 10mA for the phase reversal protection to work properly. When the amplifier is severely overdriven, an external resistor should be used to limit the overdrive current.

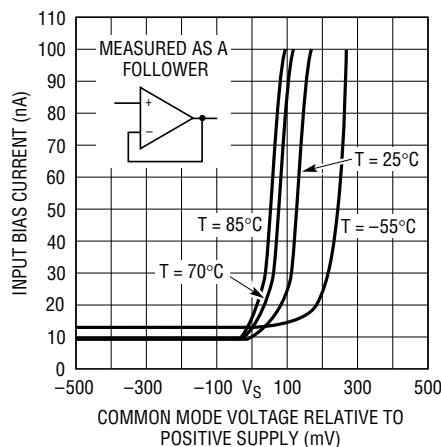

LT1218/19 • F02

Figure 2. Input Bias Current vs Common Mode Voltage

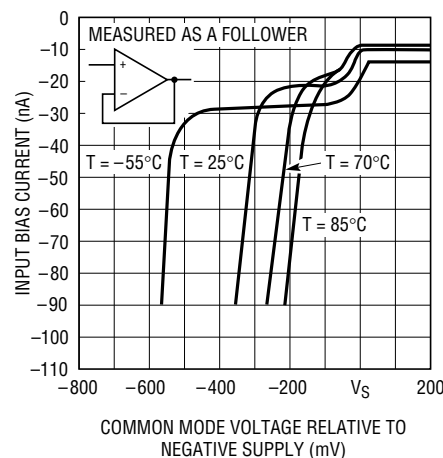

LT1218/19 • F03

Figure 3. Input Bias Current vs Common Mode Voltage

## APPLICATIONS INFORMATION

### Shutdown

The biasing of the LT1218/LT1219 is controlled by the  $\overline{\text{SHDN}}$  pin. When the  $\overline{\text{SHDN}}$  pin is low, the part is shut down. In the shutdown mode, the output looks like a 40pF capacitor and the supply current is less than 30 $\mu\text{A}$ . The  $\overline{\text{SHDN}}$  pin is referenced to the positive supply through an internal bias circuit (see Figure 1). The  $\overline{\text{SHDN}}$  pin current with the pin low is typically 3 $\mu\text{A}$ .

The switching time between the shutdown and active states is about 20 $\mu\text{s}$ , however, the total time to settle will be greater by the slew time of the amplifier. For example, if the DC voltage at the amplifier output is 0V in shutdown and -2V in the active mode, an additional 20 $\mu\text{s}$  is required. Figures 4a and 4b show the switching waveforms for a sinusoidal and a -2V DC input to the LT1218.

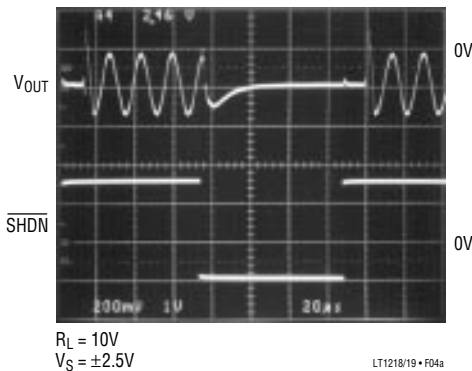

Figure 4a

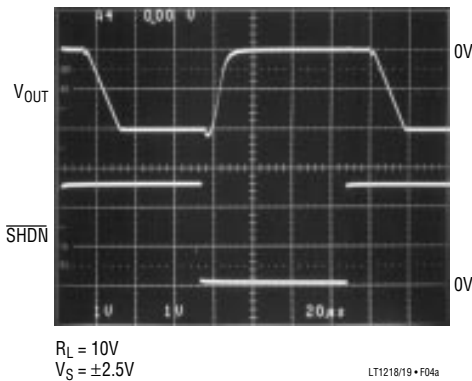

Figure 4b

The  $\overline{\text{SHDN}}$  pin can be driven directly from CMOS logic if the logic and the LT1218/LT1219 are operated from the same supplies. For higher supply operation, an interface is required. An easy way to interface between supplies is to use open-drain logic, an example is shown in Figure 5. Because the  $\overline{\text{SHDN}}$  pin is referenced to the positive supply, the logic used should have a breakdown voltage greater than the positive supply.

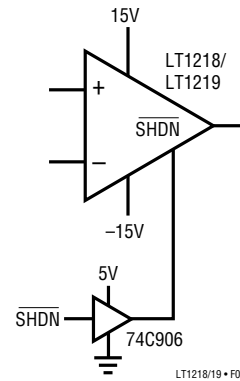

Figure 5. Shutdown Interface

### Trim Pins

Trim pins are provided for compatibility with other single op amps. Input offset voltage can be adjusted over a  $\pm 2.3\text{mV}$  range with a 10k potentiometer.

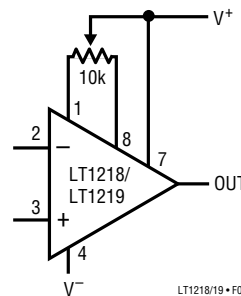

Figure 6. Optional Offset Nulling

### Improved Supply Rejection in the LT1219

The LT1219 is a variation of the LT1218 offering greater supply rejection and lower high frequency output impedance. The LT1219 requires a 0.1 $\mu\text{F}$  load capacitance for

## APPLICATIONS INFORMATION

compensation. The output capacitance forms a filter, which reduces pickup from the supply and lowers the output impedance. This additional filtering is helpful in mixed analog/digital systems with common supplies or systems employing switching supplies. Filtering also reduces high frequency noise, which may be beneficial when driving A/D converters.

Figures 7a and 7b show the outputs of the LT1218/LT1219 perturbed by a 200mV<sub>p-p</sub> 50kHz square wave added to the

positive supply. The LT1219 power supply rejection is about ten times greater than that of the LT1218 at 50kHz. Note the 5-to-1 scale change in the output voltage traces.

The tolerance of the external compensation capacitor is not critical. The plots of Overshoot vs Load Current in the Typical Performance Characteristics section illustrate the effect of a capacitive load.



LT1218/19 • F07a

Figure 7a. LT1218 Power Supply Rejection Test



LT1218/19 • F07b

Figure 7b. LT1219 Power Supply Rejection Test

## TYPICAL APPLICATIONS

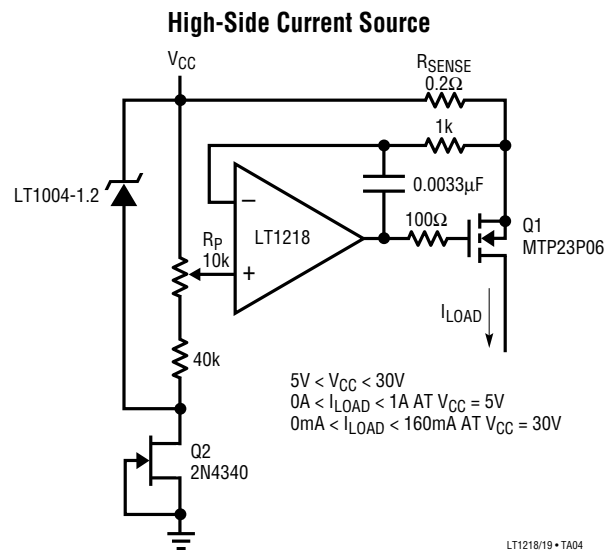

# TYPICAL APPLICATIONS

## Positive Supply Current Sense



# PACKAGE DESCRIPTION

Dimensions in inches (millimeters) unless otherwise noted.

### N8 Package 8-Lead PDIP (Narrow 0.300) (LTC DWG # 05-08-1510)

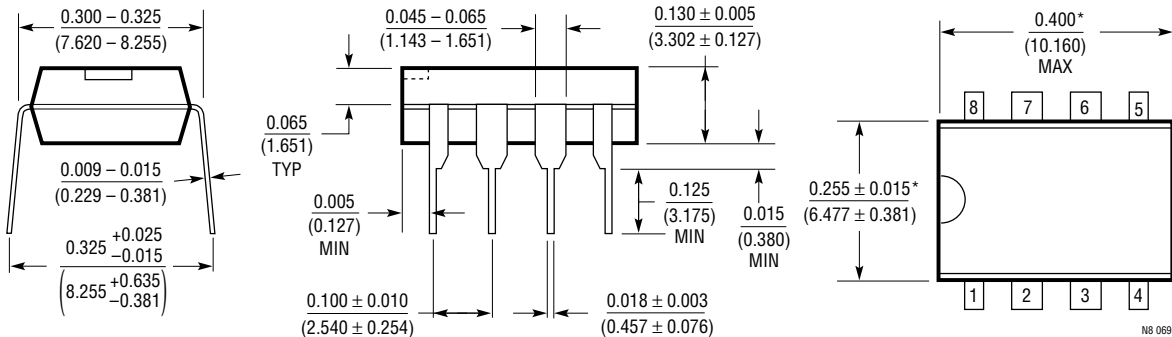

\*THESE DIMENSIONS DO NOT INCLUDE MOLD FLASH OR PROTRUSIONS.  
MOLD FLASH OR PROTRUSIONS SHALL NOT EXCEED 0.010 INCH (0.254mm)

### S8 Package 8-Lead Plastic Small Outline (Narrow 0.150) (LTC DWG # 05-08-1610)

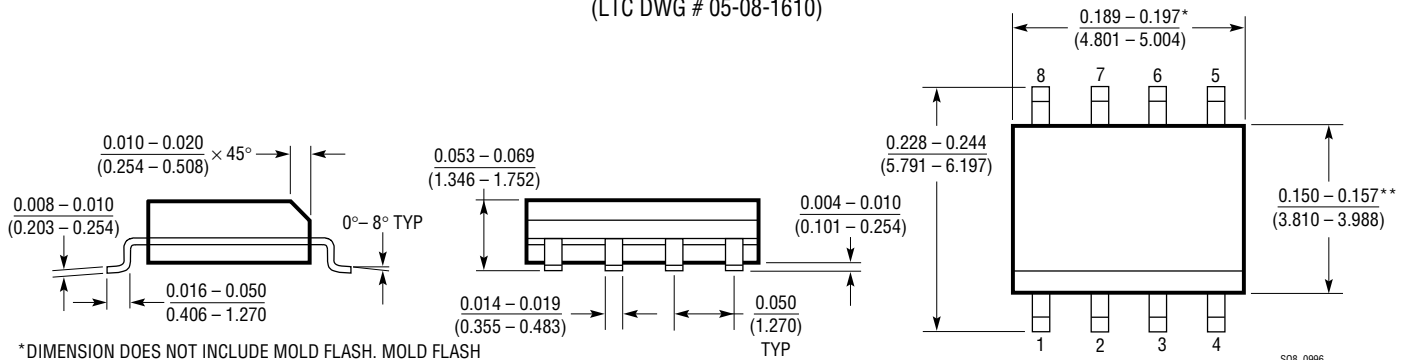

\*DIMENSION DOES NOT INCLUDE MOLD FLASH. MOLD FLASH SHALL NOT EXCEED 0.006" (0.152mm) PER SIDE

\*\*DIMENSION DOES NOT INCLUDE INTERLEAD FLASH. INTERLEAD FLASH SHALL NOT EXCEED 0.010" (0.254mm) PER SIDE

## TYPICAL APPLICATION

### 8-Channel, 12-Bit Data Acquisition System with Programmable Gain



## RELATED PARTS

PART NUMBER	DESCRIPTION	COMMENTS
LTC <sup>®</sup> 1152	Rail-to-Rail Input and Output, Zero-Drift Op Amp	High DC Accuracy, 10 $\mu$ V $V_{OS(MAX)}$ , 100nV/ $^{\circ}$ C Drift, 0.7MHz GBW, 0.5V/ $\mu$ s Slew Rate, Maximum Supply Current 3mA
LT1366/LT1367	Dual/Quad Precision, Rail-to-Rail Input and Output Op Amps	475 $\mu$ V $V_{OS(MAX)}$ , 400kHz GBW, 0.13V/ $\mu$ s Slew Rate, Maximum Supply Current 520 $\mu$ A per Op Amp
LT1466/LT1467	Dual/Quad Micropower, Rail-to-Rail Input and Output Op Amps	Maximum Supply Current 75 $\mu$ A per Op Amp, 390 $\mu$ V $V_{OS(MAX)}$ , 120kHz Gain Bandwidth



## Данный компонент на территории Российской Федерации

### Вы можете приобрести в компании MosChip.

Для оперативного оформления запроса Вам необходимо перейти по данной ссылке:

<http://moschip.ru/get-element>

Вы можете разместить у нас заказ для любого Вашего проекта, будь то серийное производство или разработка единичного прибора.

В нашем ассортименте представлены ведущие мировые производители активных и пассивных электронных компонентов.

Нашей специализацией является поставка электронной компонентной базы двойного назначения, продукции таких производителей как XILINX, Intel (ex.ALTERA), Vicor, Microchip, Texas Instruments, Analog Devices, Mini-Circuits, Amphenol, Glenair.

Сотрудничество с глобальными дистрибьюторами электронных компонентов, предоставляет возможность заказывать и получать с международных складов практически любой перечень компонентов в оптимальные для Вас сроки.

На всех этапах разработки и производства наши партнеры могут получить квалифицированную поддержку опытных инженеров.

Система менеджмента качества компании отвечает требованиям в соответствии с ГОСТ Р ИСО 9001, ГОСТ РВ 0015-002 и ЭС РД 009

### Офис по работе с юридическими лицами:

105318, г.Москва, ул.Щербаковская д.3, офис 1107, 1118, ДЦ «Щербаковский»

Телефон: +7 495 668-12-70 (многоканальный)

Факс: +7 495 668-12-70 (доб.304)

E-mail: [info@moschip.ru](mailto:info@moschip.ru)

Skype отдела продаж:

moschip.ru

moschip.ru\_4

moschip.ru\_6

moschip.ru\_9