



WIRE AND HARNESS ID PRODUCTS

2

- Heat Shrink/Cable Markers*
- Performance Labels*
- Self-Laminating Labels*
- Pre-Printed Wire & Cable Markers*



LABEL ID PRODUCTS

64

- Product Code Cross Reference*
- Thermal Transfer Labels*
- Dot Matrix Labels*
- Laser Labels*



HARDWARE/SOFTWARE

106

- Printers*
- Ribbons*
- Software*
- Application Systems*



SPECIALTY PRODUCTS

128

- Pre-Print Services*
- Permark*
- Rail — Signal Products*
- Tube and Pipe ID Labels*

REFERENCE

| | |
|--|------------|
| <i>Printer/Material/Ribbon Cross Reference</i> | 142 |
| <i>Master Material Specification Chart</i> | 144 |
| <i>Industry Icon Key</i> | 148 |
| <i>Part Number Index</i> | 149 |



Electronics

HEAT SHRINK/CABLE MARKERS

| | | | |
|---------------------------------------|----|--|----|
| TMS-SCE Military Grade Sleeves | 4 | HLX Low Fire Hazard Tags | 20 |
| CM-SCE Polyolefin Tags | 6 | D-SCE Fluid Resistant Sleeves | 22 |
| HS 2:1 Shrink Ratio Sleeves | 8 | NMX Flame Retardant Polyaramid Tags | 24 |
| HL Tie-on Tags | 10 | RPS Commercial Grade Sleeves | 26 |
| HT-SCE High Temperature Sleeves | 12 | NBC-SCE Nuclear, Biological and Chemical Resistant Sleeves | 28 |
| HTCM-SCE High Temp Tie-on Tags | 14 | TMS-CCUV UV Resistant Oversleeves .. | 30 |
| ZH-SCE Zero Halogen Sleeves | 16 | | |
| HX Low Fire Hazard Sleeves | 18 | | |



PERFORMANCE LABELS

| | |
|--------------------------------------|----|
| VF/NPVF/VF-130 Polyvinyl Fluoride .. | 32 |
| RMK-6 Epoxy Coated Polyester | 34 |
| RMK Epoxy Coated Polyester | 36 |
| TTP Polyester | 38 |
| HPK Polypropylene | 40 |
| HPC Fabric | 42 |



SELF-LAMINATING LABELS

| | |
|---|----|
| SB Thermal Transfer Vinyl | 44 |
| PVF Thermal Transfer Polyvinyl Fluoride | 46 |
| TW Dot Matrix Vinyl | 48 |
| PV Dot Matrix Polyvinyl Fluoride | 50 |
| LSR Polyester Laser Printable | 52 |
| Label Dimensions | 54 |



PRE-PRINTED WIRE & CABLE MARKERS

| | |
|-----------------------------------|----|
| K-Type Cable Markers | 56 |
| Z-Type Push On Wire Markers | 58 |
| Snap On Markers | 60 |
| CWM Wire Marker Cards | 62 |





TMS-SCE Military grade heat shrinkable wire identification sleeves

TMS-SCE marker sleeves are designed to meet the wire and cable marking needs of manufacturers with high performance requirements. Made from durable, flame retarded, radiation-crosslinked heat-shrinkable polyolefin, TMS-SCE marker sleeves can be used in a wide variety of applications. The marker sleeves meet the performance requirements of SAE-AMS- DTL-23053/5 classes 1 and 3 and the TMS-SCE-2X products are made from tubing fully compliant with this specification. The marks are permanent immediately after printing and remain legible even when exposed to abrasion, aggressive cleaning solvents, and military fuels and oils. The sleeves meet the mark permanence requirements of SAE AS8 1531 4.6.2 and MIL-STD-202F both before and after shrinking.

Both 2:1 and 3:1 shrink ratios are available. The 2:1 products provide a thick, rugged sleeve wall and are particularly easy to handle. The lightweight 3:1 products provide extremely fast shrinking and cover a wider range of wire diameters, thus simplifying inventory.

The marker sleeves are designed to be printed by computer-driven dot matrix or thermal transfer printers, providing several advantages in terms of reduced errors, cycle time and cost.

Supplied in a thin, flat "ladder" format, the sleeves are held horizontally between two hole-punched polyester strips. This configuration feeds directly from the storage box into a Tyco-recommended printer. Tyco-recommended ribbons should always be used. The ladder format provides automatic kitting of the marker sleeves in the desired sequence. A standard heat gun with reflector is used to shrink the sleeves onto the wire or cable.

Features and benefits

- Permanent identification sleeves.
- Computer-printable.
- Lightweight for aerospace applications.
- Military specification material and print performance.
- 2:1 and 3:1 shrink ratio.
- CSA Certified.
- UL Recognized, VW all flame tubing test rated.
- Quick recovery for heat sensitive areas.

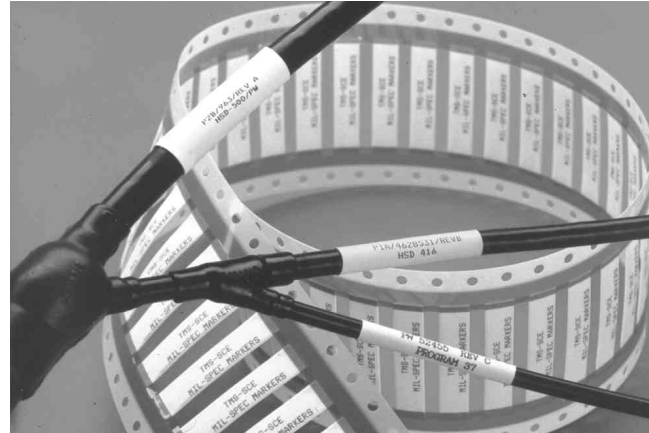

Temperature rating

| | | |
|------------------------------|-----------------|-----------------|
| Operating temperature range | -55°C to +135°C | -67°F to +275°F |
| Minimum recovery temperature | +85°C | +185°F |
| Maximum storage temperature | +40°C | +104°F |

Specifications/approvals

| | |
|----------|--|
| Tyco | RT-1805 |
| Military | SAE-AMS-DTL-23053/5 classes 1 and 3, SAE AS8 1531 4.6.2, MIL-STD-202F Method 215J |
| Industry | UL Recognized – Standard 224, file E35586 CSA Certified – File 31929 |

Printer information

| | |
|--------------|--|
| Tyco printer | LQ870 (dot matrix) |
| | T208M (thermal transfer, low volume) |
| | T312M (thermal transfer) |
| Tyco ribbon | TMS-SIX-RIBBON-A (dot matrix) |
| | TMS-101-RIBBON-4RPSCE (thermal transfer for T208M) |
| | TMS-RJS-RIBBON-4RPSCE (thermal transfer for T312M) |

Part numbering system

TMS-SCE-2X-F1K-1/8-2.0-S1-9

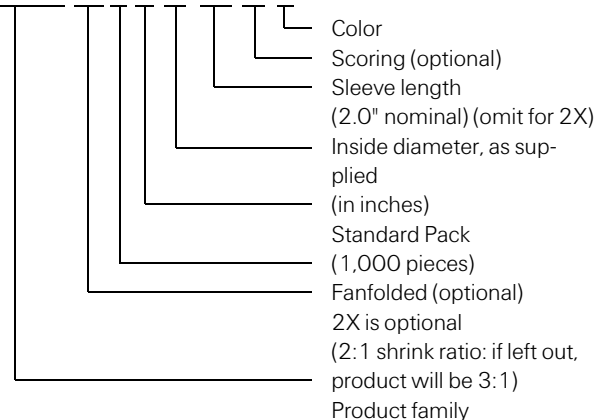

TMS-SCE Military grade heat shrinkable wire identification sleeves (Cont'd)

Ordering information

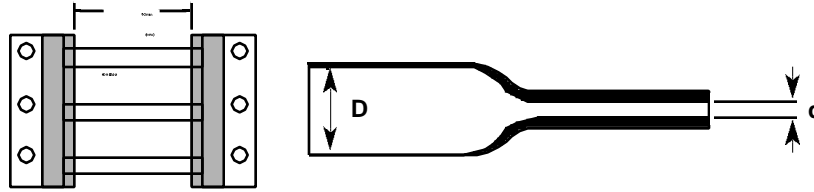

Available sizes and formats

| Ordering description | Inside diameter | | | | Recommended use range | Recovered wall thickness | | Weight (g/10 pcs.) | |
|---|----------------------|--------------|-----------------------|--------------|-----------------------|--------------------------|-----------|--------------------|-------|
| | Expanded D (minimum) | | Recovered d (maximum) | | | | | | |
| | mm | inches | mm | inches | | mm | inches | | |
| TMS-SCE-1K- $\frac{3}{8}$ -2.0- <i><color></i> | 2.36 | <i>0.093</i> | 0.79 | <i>0.031</i> | 0.81 - 1.90 | <i>0.032 - 0.075</i> | 0.53±0.08 | <i>0.021±0.003</i> | 1.50 |
| TMS-SCE-2X-1K- $\frac{3}{32}$ - <i><color></i> | 2.36 | <i>0.093</i> | 1.17 | <i>0.046</i> | 1.27 - 1.90 | <i>0.050 - 0.075</i> | 0.64±0.08 | <i>0.025±0.003</i> | 2.04 |
| TMS-SCE-1K- $\frac{1}{8}$ -2.0- <i><color></i> | 3.18 | <i>0.125</i> | 1.07 | <i>0.042</i> | 1.11 - 2.66 | <i>0.044 - 0.105</i> | 0.58±0.08 | <i>0.023±0.003</i> | 2.03 |
| TMS-SCE-2X-1K- $\frac{1}{8}$ - <i><color></i> | 3.18 | <i>0.125</i> | 1.58 | <i>0.062</i> | 1.75 - 2.66 | <i>0.069 - 0.105</i> | 0.64±0.08 | <i>0.025±0.003</i> | 2.75 |
| TMS-SCE-1K- $\frac{3}{16}$ -2.0- <i><color></i> | 4.75 | <i>0.187</i> | 1.57 | <i>0.062</i> | 1.75 - 4.06 | <i>0.069 - 0.160</i> | 0.58±0.08 | <i>0.023±0.003</i> | 2.68 |
| TMS-SCE-2X-1K- $\frac{3}{16}$ - <i><color></i> | 4.75 | <i>0.187</i> | 2.36 | <i>0.093</i> | 2.54 - 4.06 | <i>0.100 - 0.160</i> | 0.64±0.08 | <i>0.025±0.003</i> | 3.62 |
| TMS-SCE-1K- $\frac{1}{4}$ -2.0- <i><color></i> | 6.35 | <i>0.250</i> | 2.11 | <i>0.083</i> | 2.31 - 5.46 | <i>0.091 - 0.215</i> | 0.58±0.08 | <i>0.023±0.003</i> | 3.51 |
| TMS-SCE-2X-1K- $\frac{1}{4}$ - <i><color></i> | 6.35 | <i>0.250</i> | 3.18 | <i>0.125</i> | 3.81 - 5.46 | <i>0.150 - 0.215</i> | 0.64±0.08 | <i>0.025±0.003</i> | 5.94 |
| TMS-SCE-1K- $\frac{3}{8}$ -2.0- <i><color></i> | 9.53 | <i>0.375</i> | 3.18 | <i>0.125</i> | 3.47 - 8.12 | <i>0.137 - 0.320</i> | 0.61±0.08 | <i>0.024±0.003</i> | 5.04 |
| TMS-SCE-2X-1K- $\frac{3}{8}$ - <i><color></i> | 9.53 | <i>0.375</i> | 4.75 | <i>0.187</i> | 5.59 - 8.12 | <i>0.220 - 0.320</i> | 0.64±0.08 | <i>0.025±0.003</i> | 8.50 |
| TMS-SCE-1K- $\frac{1}{2}$ -2.0- <i><color></i> | 12.70 | <i>0.500</i> | 4.22 | <i>0.166</i> | 4.64 - 10.79 | <i>0.183 - 0.425</i> | 0.61±0.08 | <i>0.024±0.003</i> | 6.81 |
| TMS-SCE-2X-1K- $\frac{1}{2}$ - <i><color></i> | 12.70 | <i>0.500</i> | 6.35 | <i>0.250</i> | 6.99 - 10.79 | <i>0.275 - 0.425</i> | 0.64±0.08 | <i>0.025±0.003</i> | 11.45 |
| TMS-SCE-1K- $\frac{3}{4}$ -2.0- <i><color></i> | 19.05 | <i>0.750</i> | 6.35 | <i>0.250</i> | 6.99 - 16.25 | <i>0.275 - 0.640</i> | 0.61±0.08 | <i>0.024±0.003</i> | 12.03 |
| TMS-SCE-2X-1K- $\frac{3}{4}$ - <i><color></i> | 19.05 | <i>0.750</i> | 9.53 | <i>0.375</i> | 10.16 - 16.25 | <i>0.400 - 0.640</i> | 0.76±0.08 | <i>0.030±0.003</i> | 20.63 |
| TMS-SCE-1K-1-2.0- <i><color></i> | 25.40 | <i>1.000</i> | 8.46 | <i>0.333</i> | 9.29 - 21.59 | <i>0.366 - 0.850</i> | 0.64±0.08 | <i>0.025±0.003</i> | 15.35 |
| TMS-SCE-1K-1 $\frac{1}{2}$ -2.0- <i><color></i> | 38.10 | <i>1.500</i> | 19.05 | <i>0.750</i> | 20.95 - 33.02 | <i>0.825 - 1.300</i> | 0.51±0.08 | <i>0.020±0.003</i> | 27.51 |
| TMS-SCE-1K-2-2.0- <i><color></i> | 50.80 | <i>2.000</i> | 25.40 | <i>1.000</i> | 27.94 - 44.95 | <i>1.100 - 1.750</i> | 0.64±0.08 | <i>0.025±0.003</i> | 47.27 |
| TMS-SCE-1K-2 $\frac{1}{4}$ -2.0- <i><color></i> | 57.15 | <i>2.250</i> | 19.05 | <i>0.750</i> | 22.32 - 50.80 | <i>0.880 - 2.000</i> | 0.76±0.08 | <i>0.030±0.003</i> | 42.06 |

Total width as supplied 90.18 mm (3.550 inches) including tape and carrier width.

Options

| | | | | | | | | | | |
|---------------|--|---|---|-------|-------------|-------|-------------|--------|------|-------|
| Prescoring | Perforated score to produce multiple markers from each sleeve. | | | | | | | | | |
| | Number of prescores | 1 prescore | | | 2 prescores | | 3 prescores | | | |
| | Code | S1 | | | S2 | | S3 | | | |
| Package sizes | Standard | | 1K - 1000-piece packs | | | | | | | |
| | Nonstandard | | Smaller and larger pack sizes are available. Please contact Tyco. | | | | | | | |
| | Fanfolded | | Fanfolded option available for use with dot matrix printers | | | | | | | |
| Colors | Standard | | Yellow | White | | | | | | |
| | Code | | 4 | 9 | | | | | | |
| | Nonstandard | | Red | Pink | Orange | Green | Blue | Violet | Gray | Black |
| | Code | | 2 | 2L | 3 | 5 | 6 | 7 | 8 | 0 |
| Note: | | 2X products meet the color requirements of MIL-STD-104 class 1; otherwise colors are pastel for print contrast. | | | | | | | | |

Ordering information: Specify product name, pack size, sleeve size, prescore format, and color.

Ordering example: TMS-SCE-1K- $\frac{1}{8}$ -2.0-S1-9 (scored once)

CM-SCE Polyolefin tie-on cable marker tags

CM-SCE markers are flat, rigid, non-adhesive labels that can be used to identify large cables and wire bundles in environments such as military and aerospace. Marker tags are applied to cables or wire bundles with cable ties.

Print performance meets or exceeds the requirements of SAE AS81531 4.6.2 and MIL-STD-202F.

Features and benefits

- Side entry provides access to big size and wire bundles as well as retrofit and repair capability.
- Highly flame-retardant.
- Highly resistant to abrasion, mechanical abuses, fluids, lubricants and solvents.
- Ease of use: markers can be easily removed from the carrier.
- Easy installation: only standard cable tie-wraps are needed to install markers. No extra steps required.
- Excellent print permanence when printing on the rough side of the marker.



Temperature rating

| | | |
|-----------------------------|-----------------|-----------------|
| Operating temperature range | -55°C to +135°C | -67°F to +275°F |
|-----------------------------|-----------------|-----------------|

Specifications/approvals

| | |
|----------|--|
| Tyco | RT-1808 |
| Military | Mark permanence: SAE AS81531 4.6.2 Solvent resistance: MIL-STD-202F Method 215J |

Printer information

| | |
|--------------|---|
| Tyco printer | LQ870 (dot matrix) T312M (thermal transfer) |
| Tyco ribbon | TMS-SYSTEM-SIX-RIBBON-A (dot matrix) TMS-RJS-RIBBON-4HT (thermal transfer) |

Part numbering system

CM-SCE - F 2.5K - 1/4 - 4H-9

| |
|------------------------------------|
| Color |
| Tie-wrap holes |
| Markable height of marker (inches) |
| Pack size |
| Fanfolding package option |
| Product family |

Ordering information

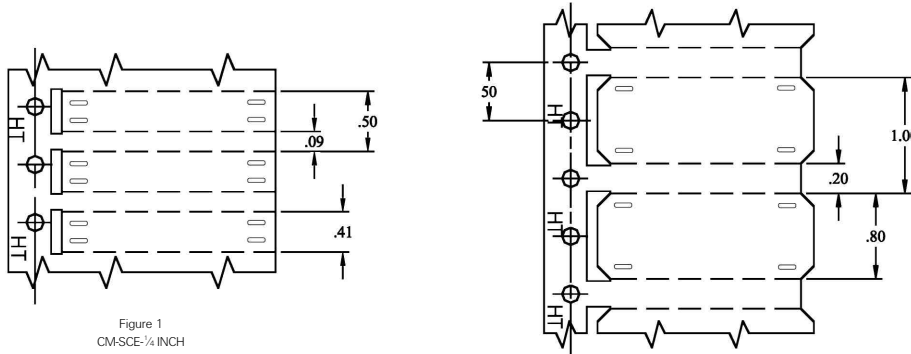

Figure 1
CM-SCE-1/4 INCH

Available sizes and formats

| Ordering description | Size | Markable height | | Markable length | | Recommended use range | |
|--|------|-----------------|---------------|-----------------|---------------|-----------------------|----------------------|
| | | mm | <i>inches</i> | mm | <i>inches</i> | mm | <i>inches</i> |
| CM-SCE-1/4-4H- <i><color></i> | 1/4 | 6.40 | <i>0.250</i> | 50.80 | <i>2.000</i> | 5.08 – 12.50 | <i>0.200 – 0.492</i> |
| CM-SCE-TP-1/4-4H- <i><color></i> * | 1/4 | 6.40 | <i>0.250</i> | 50.80 | <i>2.000</i> | 5.08 – 12.50 | <i>0.200 – 0.492</i> |
| CM-SCE-1/2-4H- <i><color></i> | 1/2 | 12.70 | <i>0.500</i> | 50.80 | <i>2.000</i> | 12.50 and up | <i>0.492 and up</i> |
| CM-SCE-TP-1/2-4H- <i><color></i> * | 1/2 | 12.70 | <i>0.500</i> | 50.80 | <i>2.000</i> | 12.50 and up | <i>0.492 and up</i> |
| CM-SCE-1/2-6H- <i><color></i> | 1/2 | 12.70 | <i>0.500</i> | 50.80 | <i>2.000</i> | 12.50 and up | <i>0.492 and up</i> |
| CM-SCE-TP-1/2-6H- <i><color></i> * | 1/2 | 12.70 | <i>0.500</i> | 50.80 | <i>2.000</i> | 12.50 and up | <i>0.492 and up</i> |

* for thermal transfer printing

Options

| | | | |
|----------------|---------------|---|-----------|
| Tie-wrap holes | 1/4-inch tags | Four holes standard | |
| | 1/2-inch tags | Four holes | Six holes |
| | Code | 4H | 6H |
| Fanfold | Code | Fx (substitute package size code for "x") | |
| Package sizes | Standard | 250 pieces | |
| Colors | Standard | White | |
| | Code | 9 | |
| | Nonstandard | Yellow | |
| | Code | 4 | |

Ordering information: Specify product name, markable height of marker, pack size, number of tie wraps and color.

Ordering example: CM-SCE-2.5K-1/4-4H-9

tyco**Electronics**

Heat Shrink/Cable Markers

HS 2:1 Shrink ratio heat shrinkable wire identification system

HS sleeves are thin wall, flame retarded radiation cross-linked polyolefin heat-shrinkable tubing, assembled as organized cut sleeves on a paper carrier. HS products are 2:1 shrink ratio. They are used in identification of wires and cables by computer-based printing onto sleeves. These products are suited to a wide variety of applications, including those with military standard requirements. The products meet the material and performance requirements of SAE AMS-DTL-23053/5 class 1.

Features and benefits

- Shrink ratio of 2:1 recovers to half of supplied diameter. Contact Tyco for 3:1 option.
- Comes in several sleeve lengths: 38mm, 50mm and 152mm.
- Sleeve diameter from 0.093" to 1.5" (2.4mm to 38.1mm).
- Flame retarded – meets ASTM D 2671 and UL224 (clause 14) standards.
- Single sided and double sided printing formats available.
- Standard dot matrix printable. Contact Tyco for thermal printable options.
- Heat resistance: +175°C (+347°F) for 168 hours or +250°C (+482°F) for 4 hours with no deterioration of properties.
- Concentricity: 70% minimum for low distortion of legends.
- Easy-to-use fan-fold format for improved kitting and marker selection.

**Temperature rating**

| | | |
|------------------------------|-----------------|-----------------|
| Operating temperature range | -55°C to +135°C | -67°F to +275°F |
| Minimum recovery temperature | +120°C | +248°F |
| Maximum storage temperature | +40°C | +104°F |

Specifications/approvals

| | |
|----------|--|
| Tyco | TTDS-033 |
| Military | SAE AMS-DTL-23053/5 Class 1 (material and performance) SAE AS81531 4.6.2 MIL-STD-202F Method 215J |
| Industry | ASTM D 2671 UL 224 (clause 14) |

Printer information

| | |
|--------------|---|
| Tyco printer | AM6310 (dot matrix) |
| Tyco ribbon | 1892BK03 (dot matrix – high performance) 1892BK04 (dot matrix) |

Part numbering system

| | | | | | | | |
|----|-----|----|---|----|-----|---|----------------------------------|
| HS | 048 | YW | 1 | NF | 050 | B | |
| | | | | | | | Pack size |
| | | | | | | | Sleeve length (mm) |
| | | | | | | | Format |
| | | | | | | | Scoring |
| | | | | | | | Color |
| | | | | | | | Inside diameter as supplied (mm) |
| | | | | | | | Product family |

HS 2:1 Shrink ratio heat shrinkable wire identification system (Cont'd)

Ordering information

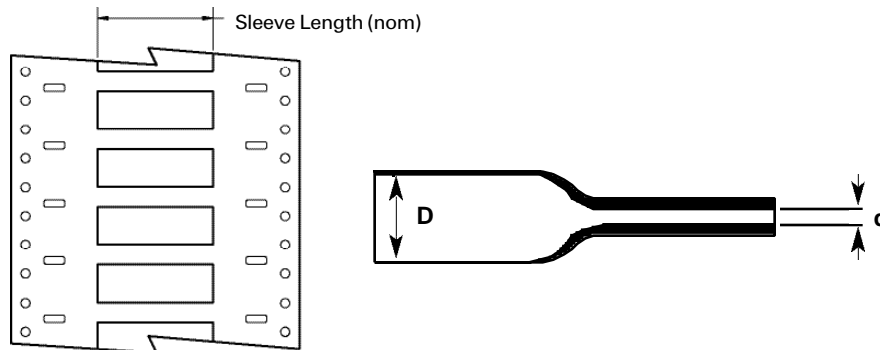

Available sizes and formats

| Ordering description | Inside diameter | | | | Recommended use range | | Pack size (uncut sleeves) | | |
|--|------------------------|--------|---------------------------|--------|-----------------------|-------------|---------------------------|----------------|-------|
| | D (min) As supplied | | d (max) After recovery | | | | NF(B) | DS(B) | WF(B) |
| | mm | inches | mm | inches | mm | inches | 38 and 50mm lengths | 152 mm lengths | |
| HS024-<color-prescore-format-length-pack size> | 2.40 | 0.093 | 1.17 | 0.050 | 1.27-1.90 | 0.050-0.075 | 1650 | 1100 | N/A |
| HS032-<color-prescore-format-length-pack size> | 3.20 | 0.126 | 1.58 | 0.060 | 1.75-2.66 | 0.069-0.105 | 1100 | 1100 | 550 |
| HS048-<color-prescore-format-length-pack size> | 4.80 | 0.189 | 2.36 | 0.090 | 2.54-4.06 | 0.100-0.160 | 1100 | 1100 | 500 |
| HS064-<color-prescore-format-length-pack size> | 6.35 | 0.250 | 3.18 | 0.125 | 3.81-5.46 | 0.150-0.215 | 550 | 550 | 500 |
| HS095-<color-prescore-format-length-pack size> | 9.53 | 0.374 | 4.75 | 0.187 | 5.59-8.12 | 0.220-0.320 | 550 | 550 | 275 |
| HS127-<color-prescore-format-length-pack size> | 12.70 | 0.500 | 6.35 | 0.250 | 6.99-10.79 | 0.275-0.425 | 550 | 300 | 250 |
| HS190-<color-prescore-format-length-pack size> | 19.05 | 0.750 | 9.53 | 0.375 | 10.16-16.25 | 0.400-0.640 | 300 | 300 | 175 |
| HS254-<color-prescore-format-length-pack size> | 25.40 | 1.000 | 12.70 | 0.500 | 9.29-21.59 | 0.366-0.850 | 300 | 300 | 125 |
| HS381-<color-prescore-format-length-pack size> | 38.10 | 1.500 | 19.05 | 0.750 | 20.95-22.02 | 0.825-1.300 | 100 | 100 | 75 |

Options

| | | | | | | |
|---------------------|---|---|------------|----------------------------------|-------------|--------------|
| Prescoring | Perforated score to produce multiple marker sleeves from each HS. | | | | | |
| | Number of prescores | 0 prescores | 1 prescore | 2 prescores | 3 prescores | 5* prescores |
| | Markers per sleeve | 1 | 2 | 3 | 4 | 6* |
| | Code | 1 | 2 | 3 | 4 | 6* |
| *Wide format only | | | | | | |
| Package sizes | B | Standard for narrow format: NF (single sided) and DS (double sided) | | | | |
| | X | Bulk for narrow format (contains double the number of markers in a narrow format B pack): NF (single sided) | | | | |
| | B | Standard for wide format: WF (single sided) | | | | |
| Colors | Standard | White | Yellow | | | |
| | Code | WE | YW | | | |
| Format | NF | Single-sided printing – narrow format | | | | |
| | DS | Double-sided printing – narrow format | | | | |
| | WF | Single-sided printing – wide format | | | | |
| Uncut sleeve length | 038 | 38 mm (1.5") – narrow format | | Ordering example: HS032WE2NF038B | | |
| | 050 | 50 mm (2") – narrow format | | Ordering example: HS064YW3NF050X | | |
| | 152 | 152 mm (6") – wide format | | Ordering example: HS095WE6WF152B | | |

Ordering information: Specify product name, color, prescores, format, sleeve length and pack size.

Ordering example: HS032WE2NF038B

HL Tie-on cable marker tags

Used to identify large cables and bundles either pre- or post-termination, these flame retarded HL cable markers are suitable for use in environments with temperatures of -55°C to $+135^{\circ}\text{C}$ (-67°F to $+275^{\circ}\text{F}$). The markers are easily applied with standard cable ties.

HL markers are presented as organized markers assembled onto either a fanfolded or reeled paper carrier for ease of selection and kitting and are available in an extensive range of sizes.

They are available with the surface designed for either dot matrix or thermal transfer printers.

Features and benefits

- Recommended for use where de-termination of wires is not possible for large ID wires or wire bundles.
- Heat resistant to $+175^{\circ}\text{C}$ for 168 hours or $+250^{\circ}\text{C}$ for 4 hours with no deterioration in properties.
- Several printable widths and heights available.
- Non-standard color options available.

**Temperature rating**

| | | |
|-----------------------------|---|---|
| Operating temperature range | -55°C to $+135^{\circ}\text{C}$ | -65°F to $+275^{\circ}\text{F}$ |
|-----------------------------|---|---|

Specifications/approvals

| | |
|----------|--|
| Tyco | TTDS-037 |
| Military | SAE AS81531 4.6.2 MIL-STD-202F Method 2.15J |
| Industry | UL 224 (clause 14) ASTM D 2671 |

Printer information

| | |
|--------------|---|
| Tyco printer | AM 6310 (dot matrix) T312M (thermal transfer) |
| Tyco ribbon | 1892BK04 (dot matrix) 1892BK03 (dot matrix – high performance) TMS-RJS-RIBBON-4RPSCE (thermal transfer) |

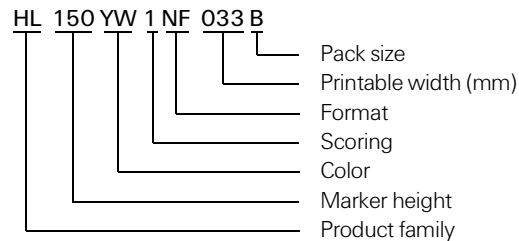
Part numbering system

HL Tie-on cable marker tags (Cont'd)

Ordering information

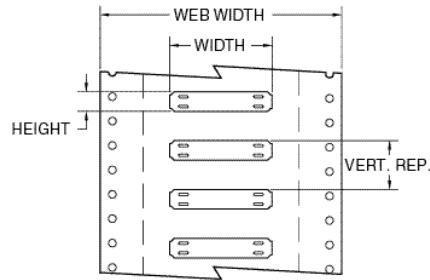

Available sizes and formats

| Ordering description | Marker dimensions (W X H) | | Printable area (W X H) | | Pack size | |
|---------------------------|---------------------------|----------------------|------------------------|----------------------|-----------|------|
| | mm | <i>inches</i> | mm | <i>inches</i> | NF | TS |
| HL104<color>1<format>025B | 45.00 x 10.40 | <i>1.800 x 0.400</i> | 25.00 x 10.40 | <i>1.000 x 0.400</i> | 550 | 1000 |
| HL104<color>1<format>033B | 52.00 x 10.40 | <i>2.100 x 0.400</i> | 33.00 x 10.40 | <i>1.300 x 0.400</i> | 550 | 1000 |
| HL104<color>1<format>038B | 58.00 x 10.40 | <i>2.300 x 0.400</i> | 38.00 x 10.40 | <i>1.500 x 0.400</i> | 550 | 1000 |
| HL104<color>1<format>050B | 70.00 x 10.40 | <i>2.750 x 0.400</i> | 50.00 x 10.40 | <i>2.000 x 0.400</i> | 550 | 1000 |
| HL104<color>1<format>070B | 90.00 x 10.40 | <i>3.500 x 0.400</i> | 70.00 x 10.40 | <i>2.750 x 0.400</i> | 550 | 1000 |
| HL150<color>1<format>025B | 45.00 x 15.00 | <i>1.800 x 0.600</i> | 25.00 x 15.00 | <i>1.000 x 0.600</i> | 550 | 500 |
| HL150<color>1<format>033B | 52.00 x 15.00 | <i>2.100 x 0.600</i> | 33.00 x 15.00 | <i>1.300 x 0.600</i> | 550 | 500 |
| HL150<color>1<format>038B | 58.00 x 15.00 | <i>2.300 x 0.600</i> | 38.00 x 15.00 | <i>1.500 x 0.600</i> | 550 | 500 |
| HL150<color>1<format>050B | 70.00 x 15.00 | <i>2.750 x 0.600</i> | 50.00 x 15.00 | <i>2.000 x 0.600</i> | 550 | 500 |
| HL150<color>1<format>070B | 90.00 x 15.00 | <i>3.500 x 0.600</i> | 70.00 x 15.00 | <i>2.750 x 0.600</i> | 550 | 500 |
| HL203<color>1<format>025B | 45.00 x 20.30 | <i>1.800 x 0.800</i> | 25.00 x 20.30 | <i>1.000 x 0.800</i> | 550 | 500 |
| HL203<color>1<format>033B | 52.00 x 20.30 | <i>2.100 x 0.800</i> | 33.00 x 20.30 | <i>1.300 x 0.800</i> | 550 | 500 |
| HL203<color>1<format>038B | 58.00 x 20.30 | <i>2.300 x 0.800</i> | 38.00 x 20.30 | <i>1.500 x 0.800</i> | 550 | 500 |
| HL203<color>1<format>050B | 70.00 x 20.30 | <i>2.750 x 0.800</i> | 50.00 x 20.30 | <i>2.000 x 0.800</i> | 550 | 500 |
| HL203<color>1<format>070B | 90.00 x 20.30 | <i>3.500 x 0.800</i> | 70.00 x 20.30 | <i>2.750 x 0.800</i> | 550 | 500 |
| HL253<color>1<format>025B | 45.00 x 25.30 | <i>1.800 x 1.000</i> | 25.00 x 25.30 | <i>1.000 x 1.000</i> | 300 | 250 |
| HL253<color>1<format>033B | 52.00 x 25.30 | <i>2.100 x 1.000</i> | 33.00 x 25.30 | <i>1.300 x 1.000</i> | 300 | 250 |
| HL253<color>1<format>038B | 58.00 x 25.30 | <i>2.300 x 1.000</i> | 38.00 x 25.30 | <i>1.500 x 1.000</i> | 300 | 250 |
| HL253<color>1<format>050B | 70.00 x 25.30 | <i>2.750 x 1.000</i> | 50.00 x 25.30 | <i>2.000 x 1.000</i> | 300 | 250 |
| HL253<color>1<format>070B | 90.00 x 25.30 | <i>3.500 x 1.000</i> | 70.00 x 25.30 | <i>2.750 x 1.000</i> | 300 | 250 |

Options

| | | | |
|---------------------------|--|--|--------|
| Prescoring | Not available on these products – this should always be 1. | | |
| Package sizes | Standard | B | |
| Colors | Standard | White | Yellow |
| | Code | WE | YW |
| Format | Nonstandard | Red | Blue |
| | Code | RD | BE |
| Format | NF | – Dot matrix printing (fanfold/single sided) | |
| | TS | – Thermal transfer (reel/single sided) | |
| Printable Width On Marker | 025 | 25mm (1") | |
| | 033 | 33mm (1.3") | |
| | 038 | 38mm (1.5") | |
| | 050 | 50mm (2") | |
| | 070 | 70mm (2.75") | |

Ordering information: Specify product name, marker height, color, scoring option (always 1), format, printable width, and pack size.

Ordering example: HL150YW1NF033B

HT-SCE High temperature, low outgassing heat shrinkable wire identification sleeves

Tyco's HT-SCE wire markers are designed for use in high temperature applications or where extreme resistance to fuels, lubricants and cleaning solvents is required. They are also ideal for applications in which low-vacuum outgassing is critical. The marker sleeves are made of highly flame retarded, heat-shrinkable fluoropolymer tubing.

HT-SCE markers are supplied as a thin, flat "ladder" of sleeves held horizontally between two polyester strips. This configuration feeds directly from the storage box into standard Tyco recommended printers, with no modifications necessary. A strip of adhesive tape on each side of the sleeves holds them securely in place for printing and kitting, yet the sleeves pull easily from the carrier strips. A standard heat gun with reflector is used to shrink the sleeves onto the wire or cable to achieve a permanent mark.

After shrinking, HT-SCE markers meet the print performance requirements of SAE AS81531 4.6.2 and MIL-STD-202F. HT-SCE markers are supplied in boxes of 1000 sleeves and are available in nine diameter sizes. These cover substrates from 0.8 mm to 34.0 mm. Because of this versatility, customers need not carry a large inventory of markers.

Features and benefits

- Permanent identification sleeves.
- High continuous operating temperature.
- Extreme fluid resistance.
- Low-vacuum outgassing.
- Wide range of sleeve sizes for several wire and bundle diameters.

**Temperature rating**

| | | |
|------------------------------|-----------------|-----------------|
| Operating temperature range | -55°C to +225°C | -67°F to +437°F |
| Minimum recovery temperature | +200°C | +392°F |
| Maximum storage temperature | +40°C | +104°F |

Specifications/approvals

| | |
|----------|---|
| Tyco | RT1806 |
| Military | SAEAS 81531 4.6.2 MIL-STD-202F Method 215J |

Printer information

| | |
|--------------|---------------------------------------|
| Tyco printer | T3 12M (thermal transfer) |
| Tyco ribbon | TMS-RJS-RIBBON-4HT (thermal transfer) |

Part numbering system

HT-SCE-1K-1/4-2.0-S1-0

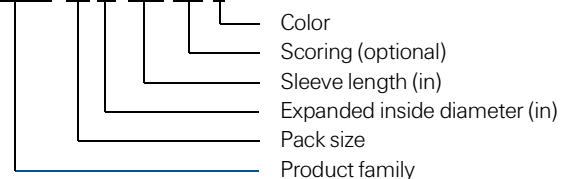

Ordering information

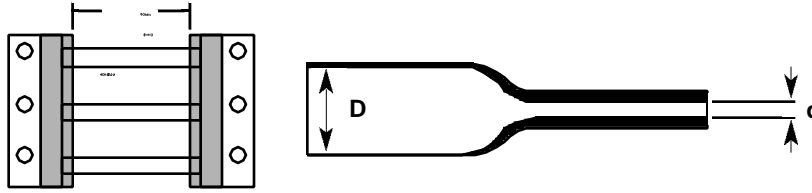

Available sizes and formats

| Ordering description | Inside diameter | | | | |
|---|------------------------|--------|---------------------------|--------|--------------------------------|
| | D (min) As supplied | | d (max) After recovery | | Recommended use range |
| | mm | inches | mm | inches | |
| HT-SCE-1K- $\frac{2}{3}$ -2.0- <color> | 2.36 | 0.093 | 0.79 | 0.031 | 0.81 - 1.90 0.032 - 0.075 |
| HT-SCE-1K- $\frac{1}{8}$ -2.0- <color> | 3.18 | 0.125 | 1.58 | 0.062 | 1.75 - 2.66 0.069 - 0.105 |
| HT-SCE-1K- $\frac{3}{16}$ -2.0- <color> | 4.75 | 0.187 | 2.36 | 0.093 | 2.54 - 4.06 0.100 - 0.160 |
| HT-SCE-1K- $\frac{1}{4}$ -2.0- <color> | 6.35 | 0.250 | 3.18 | 0.125 | 3.40 - 6.00 0.134 - 0.236 |
| HT-SCE-1K- $\frac{3}{8}$ -2.0- <color> | 9.53 | 0.375 | 4.75 | 0.187 | 5.30 - 8.10 0.209 - 0.319 |
| HT-SCE-1K- $\frac{1}{2}$ -2.0- <color> | 12.70 | 0.500 | 6.35 | 0.250 | 6.60 - 11.40 0.260 - 0.449 |
| HT-SCE-1K- $\frac{3}{4}$ -2.0- <color> | 18.00 | 0.709 | 9.00 | 0.354 | 9.90 - 15.30 0.390 - 0.602 |
| HT-SCE-1K-1-2.0- <color> | 25.40 | 1.000 | 12.70 | 0.500 | 13.30 - 23.00 0.524 - 0.906 |
| HT-SCE-1K-1 $\frac{1}{2}$ -2.0- <color> | 38.10 | 1.500 | 19.05 | 0.750 | 20.95 - 34.00 0.825 - 1.339 |

Total width as supplied 90.18 mm (3.550 inches) including tape and carrier width.

Options

| | | | | |
|--------------|---|---|-------------|-------------|
| Prescoring | Perforated score to produce multiple marker sleeves from each HT-SCE sleeve | | | |
| | Number of prescores | 1 prescore | 2 prescores | 3 prescores |
| | Code | S1 | S2 | S3 |
| Package size | Standard | 1K - 1000 piece packs | | |
| | Nonstandard | Larger pack sizes are available. Please contact Tyco. | | |
| Colors | Standard | White | Black | |
| | Code | 9 | 0 | |
| | Nonstandard | Pink | Blue | Yellow |
| Code | 2L | 6 | 4 | |

Ordering information: Specify product name, pack size, sleeve size, prescore, format and color.

Ordering example: HT-SCE-1K- $\frac{1}{4}$ -2.0-S1-9

HTCM-SCE High temperature tie-on-cable marker tags

HTCM-SCE markers are flat, rigid, non-adhesive labels that can be used to identify large cables and wire bundles in high temperature environments and outer space applications where low vacuum out-gassing is required. Marker tags are applied to cables or wire bundles using cable ties.

Print performance meets or exceeds the requirements of SAE AS8 1531 4.6.2 and MIL-STD-202F.

Features and benefits

- Side entry provides access to big size cables and wire bundles as well as retrofit and repair capability.
- High temperature use.
- Highly flame-retardant.
- Highly resistant to abrasion, mechanical abuses, fluids, lubricants and solvents.
- Low vacuum outgassing for outer space applications.
- Ease of use: markers can be easily removed from the carrier.
- Easy installation: only standard cable tie-wraps are needed to install markers. No extra steps required.
- Excellent print permanence when printing on the rough side of the marker.

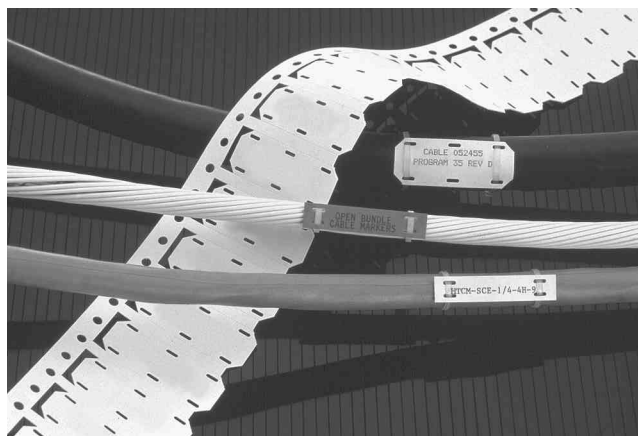

Temperature rating

Operating temperature range -55°C to +225°C -67°F to +437°F

Specifications/approvals

| | |
|----------|--|
| Tyco | RW3024 |
| Military | Mark permanence: SAE AS8 1531 4.6.2 |
| | Solvent resistance: MIL-STD-202F Method 215J |

Printer information

| | |
|--------------|---------------------------------------|
| Tyco printer | LQ870 (dot matrix) |
| | T312M (thermal transfer) |
| Tyco ribbon | TMS-SYSTEM-SIX-RIBBON-A (dot matrix) |
| | TMS-RJS-RIBBON-4HT (thermal transfer) |

Part numbering system

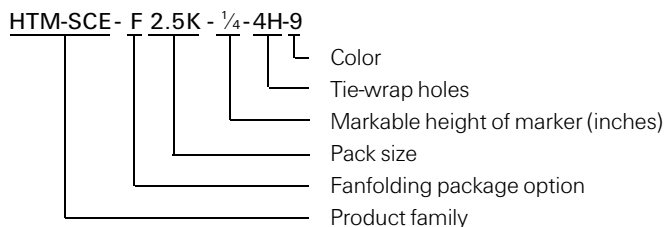

Ordering information



Figure 1
HTCM-SCE-1/4 INCH

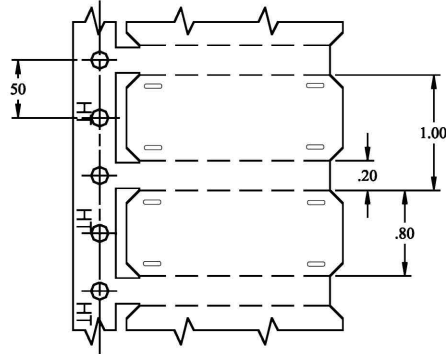

Figure 2

Available sizes and formats

| Ordering description | Size | Markable height | | Markable length | | Recommended use range | |
|--|------|-----------------|---------------|-----------------|---------------|-----------------------|----------------------|
| | | mm | <i>inches</i> | mm | <i>inches</i> | mm | <i>inches</i> |
| HTCM-SCE-1/4-4H- <i><color></i> | 1/4 | 6.40 | <i>0.250</i> | 50.80 | <i>2.000</i> | 5.08 – 12.50 | <i>0.200 – 0.492</i> |
| HTCM-SCE-TP-1/4-4H- <i><color></i> * | 1/4 | 6.40 | <i>0.250</i> | 50.80 | <i>2.000</i> | 5.08 – 12.50 | <i>0.200 – 0.492</i> |
| HTCM-SCE-1/2-4H- <i><color></i> | 1/2 | 12.70 | <i>0.500</i> | 50.80 | <i>2.000</i> | 12.50 and up | <i>0.492 and up</i> |
| HTCM-SCE-TP-1/2-4H- <i><color></i> * | 1/2 | 12.70 | <i>0.500</i> | 50.80 | <i>2.000</i> | 12.50 and up | <i>0.492 and up</i> |
| HTCM-SCE-1/2-6H- <i><color></i> | 1/2 | 12.70 | <i>0.500</i> | 50.80 | <i>2.000</i> | 12.50 and up | <i>0.492 and up</i> |
| HTCM-SCE-TP-1/2-6H- <i><color></i> * | 1/2 | 12.70 | <i>0.500</i> | 50.80 | <i>2.000</i> | 12.50 and up | <i>0.492 and up</i> |

* for thermal transfer printing

Options

| | | | |
|----------------|---------------|---|-----------|
| Tie-wrap holes | 1/4-inch tags | Four holes standard | |
| | 1/2-inch tags | Four holes | Six holes |
| | Code | 4H | 6H |
| Fanfold | Code | Fx (substitute package size code for "x") | |
| Package sizes | Standard | 250 pieces | |
| Colors | Standard | White | |
| | Code | 9 | |
| | Nonstandard | Yellow | |
| | Code | 4 | |

Ordering information: Specify product name, markable height of marker, pack size, number of tie wraps and color.

Ordering example: HTCM-SCE - F2.5K - 1/4-4H-9

ZH-SCE Zero halogen heat shrinkable wire identification sleeves

ZH-SCE identification sleeves are for use in enclosed spaces in marine, mass transit, offshore and industrial installations.

ZH-SCE has a 2:1 shrink ratio and is printed using Tyco approved printing equipment and ribbons. The printed mark is permanent immediately after printing and remains legible after exposure to abrasion, aggressive cleaning fluids, military fuels and oils.

Supplied in a thin, flat "ladder" format, the sleeves are held horizontally between two hole-punched polyester strips. This configuration feeds directly from the storage box into a Tyco recommended printer. The ladder format provides automatic kitting of the marker sleeves in the desired sequence.

Features and benefits

- Permanent identification sleeves.
- Computer printable.
- Extremely low smoke and acid gas emission.
- 2:1 shrink ratio.
- Standard side scored for easy application.



Temperature rating

| | | |
|------------------------------|-----------------|-----------------|
| Operating temperature range | -30°C to +105°C | -22°F to +221°F |
| Minimum recovery temperature | +120°C | +248°F |
| Maximum storage temperature | +40°C | +104°F |

Specifications/approvals

| | |
|----------|---|
| Tyco | RW 2030 |
| Military | SAE AS81531 4.6.2 MIL-STD-202F Method 215J |
| Industry | BS 6853 [1999] – Vehicle Category 1a |

Printer information

| | |
|--------------|---------------------------------------|
| Tyco printer | T312M (thermal transfer) |
| Tyco ribbon | TMS-RJS-RIBBON-4ZH (thermal transfer) |

Part numbering system



Ordering information



Available sizes and formats

| Ordering description | Inside diameter | | | | Recommended use range | |
|--|---------------------|--------|------------------------|--------|-----------------------|---------------|
| | D (min) as supplied | | d (max) after recovery | | | |
| | mm | inches | mm | inches | mm | inches |
| ZH-SCE-1K- $\frac{3}{8}$ -2.0- <color> | 2.36 | 0.093 | 1.17 | 0.046 | 1.27 - 1.90 | 0.050 - 0.075 |
| ZH-SCE-1K- $\frac{1}{8}$ -2.0- <color> | 3.18 | 0.125 | 1.57 | 0.062 | 1.75 - 2.66 | 0.069 - 0.105 |
| ZH-SCE-1K- $\frac{3}{16}$ -2.0- <color> | 4.75 | 0.187 | 2.36 | 0.093 | 2.54 - 4.06 | 0.100 - 0.160 |
| ZH-SCE-1K- $\frac{1}{4}$ -2.0- <color> | 6.35 | 0.250 | 3.18 | 0.125 | 3.40 - 5.50 | 0.134 - 0.217 |
| ZH-SCE-1K- $\frac{3}{8}$ -2.0- <color> | 9.53 | 0.375 | 4.75 | 0.187 | 5.00 - 9.00 | 0.197 - 0.354 |
| ZH-SCE-1K- $\frac{1}{2}$ -2.0- <color> | 12.70 | 0.500 | 6.35 | 0.250 | 6.99 - 10.79 | 0.275 - 0.425 |
| ZH-SCE-1K- $\frac{3}{4}$ -2.0- <color> | 19.05 | 0.750 | 9.53 | 0.375 | 9.90 - 15.30 | 0.390 - 0.602 |
| ZH-SCE-1K-1-2.0- <color> | 25.40 | 1.000 | 12.70 | 0.500 | 13.30 - 23.00 | 0.524 - 0.906 |
| ZH-SCE-1K-1- $\frac{1}{2}$ -2.0- <color> | 38.10 | 1.500 | 19.05 | 0.750 | 20.00 - 34.00 | 0.787 - 1.339 |

Total width as supplied 90.18 mm (3.550 inches) including tape and carrier width.

Options

| | | | | | |
|---------------|--|---|-------------|-------------|--|
| Prescoring | Perforated score to produce multiple marker sleeves from each ZH-SCE sleeve. | | | | |
| | Standard | Side scored | | | |
| | Number of prescores | 1 prescore | 2 prescores | 3 prescores | |
| Code | S1 | S2 | S3 | | |
| Package sizes | Standard | 1K - 1000 piece packages available for all ZH-SCE sizes | | | |
| | Nonstandard | Larger pack sizes are available. Please contact Tyco. | | | |
| Colors | Standard | White | Yellow | | |
| | Code | 9 | 4 | | |
| | Nonstandard | Red | Green | Blue | |
| Code | 2 | 5 | 6 | | |

Ordering information: Specify product name, pack size, sleeve size, prescore, format and color.

Ordering example: ZH-SCE-1K- $\frac{1}{4}$ -2.0-S1-9

tyco**Electronics**

Heat Shrink/Cable Markers

HX Low fire hazard heat shrinkable wire identification sleeves

HXwire identification sleeves are used to identify wires and cables where low fire hazard properties are critical. The zero halogen material coupled with low smoke and low toxic fume emissions make this product ideal for use in enclosed spaces such as mass transit, marine and industrial installations. HX markers are suitable for use in environments with temperatures of -30°C to $+105^{\circ}\text{C}$ (-22°F to $+221^{\circ}\text{F}$).

These 2:1 shrink ratio markers are assembled as organized cut sleeves onto a paper carrier for ease of marker selection and kitting. The assembled sleeves are available in both single and double sided printable formats.

Features and benefits

- Shrink ratio of 2:1 (recovers to half of supplied diameter).
- Flame retardant – meets ASTM E 162.
- Smoke emission – meets ASTM E 662.
- No secondary mark curing process is required.
- Self-extinguishing.
- Sleeve diameter from 0.125" to 1.50" (3.2 mm to 38.1 mm).
- Sleeve lengths from 0.5" to 2.0" (12.7 mm to 50.8 mm).
- Concentricity: 70% minimum for low distortion of legends.
- Printable on two sides for additional ease in identification.

**Temperature rating**

| | | |
|------------------------------|---|---|
| Operating temperature range | -30°C to $+105^{\circ}\text{C}$ | -22°F to $+221^{\circ}\text{F}$ |
| Minimum recovery temperature | $+135^{\circ}\text{C}$ | $+275^{\circ}\text{F}$ |
| Maximum storage temperature | $+40^{\circ}\text{C}$ | $+104^{\circ}\text{F}$ |

Specifications/approvals

| | |
|----------|---|
| Tyco | RW 2066 |
| Military | SAE AS81531 4.6.2 MIL-STD-202F Method 215J |
| Industry | BS 6853 [1999] – Vehicle category 1a |

Printer information

| | |
|--------------|---|
| Tyco printer | AM6310 (dot matrix) T312M (thermal transfer) |
| Tyco ribbon | 1892BK03 (dot matrix) 1950-RIBBON-4T300 (thermal transfer) |

Part numbering system

Ordering information



Available sizes and formats

| Ordering description | Inside diameter | | | | Recommended use range | | Pack size | |
|---|------------------------|---------------|---------------------------|---------------|-----------------------|--------------------|---------------------------|------|
| | D (min) As supplied | | d (max) After recovery | | | | B pack (uncut sleeves) | |
| | mm | <i>inches</i> | mm | <i>inches</i> | mm | <i>inches</i> | NF | DS |
| HX-032-<color-prescore-format-length-pack size> | 3.20 | <i>0.126</i> | 1.58 | <i>0.060</i> | 1.75-2.66 | <i>0.069-0.105</i> | 1100 | 1100 |
| HX-048-<color-prescore-format-length-pack size> | 4.80 | <i>0.189</i> | 2.36 | <i>0.090</i> | 2.54-4.06 | <i>0.100-0.160</i> | 1100 | 1100 |
| HX-064-<color-prescore-format-length-pack size> | 6.40 | <i>0.250</i> | 3.18 | <i>0.125</i> | 3.81-5.46 | <i>0.150-0.215</i> | 550 | 550 |
| HX-095-<color-prescore-format-length-pack size> | 9.50 | <i>0.374</i> | 4.75 | <i>0.187</i> | 5.59-8.12 | <i>0.220-0.320</i> | 550 | 550 |
| HX-127-<color-prescore-format-length-pack size> | 12.70 | <i>0.500</i> | 6.35 | <i>0.250</i> | 6.99-10.79 | <i>0.275-0.425</i> | 550 | 300 |
| HX-190-<color-prescore-format-length-pack size> | 19.00 | <i>0.750</i> | 9.53 | <i>0.375</i> | 10.16-16.25 | <i>0.400-0.640</i> | 300 | 300 |
| HX-254-<color-prescore-format-length-pack size> | 25.40 | <i>1.000</i> | 12.70 | <i>0.500</i> | 14.29-21.59 | <i>0.563-0.850</i> | 300 | 300 |
| HX-381-<color-prescore-format-length-pack size> | 38.10 | <i>1.500</i> | 19.05 | <i>0.750</i> | 20.95-33.02 | <i>0.825-1.300</i> | 100 | 100 |

Options

| | | | | | |
|---------------|--|--|------------|-------------|-------------|
| Prescoring | Perforated score to produce multiple marker sleeves from each HX sleeve. | | | | |
| | Number of prescores | 0 prescores | 1 prescore | 2 prescores | 3 prescores |
| | Markers per sleeve | 1 | 2 | 3 | 4 |
| | Code | 1 | 2 | 3 | 4 |
| Package sizes | B | Standard for narrow format (NF and DS) | | | |
| | X | Bulk (contains double the number of markers in a B pack) | | | |
| Colors | Standard | White | Yellow | | |
| | Code | WE | YW | | |
| | Nonstandard | Red* | Blue* | Green | Orange |
| | | RD | BE | GN | OE |
| | | *Available in DS only | | | |
| Format | NF | Single-sided printing (dot matrix only) | | | |
| | DS | Double-sided printing (thermal and dot matrix) | | | |
| Sleeve length | 038 | 38 mm | | | |
| | 044 | 44 mm (available in NF only) | | | |
| | 050 | 50 mm | | | |

Ordering information: Specify product name, color, prescores, format, sleeve length and pack size.

Ordering example: HX064YW2DS050X

HLX Low fire hazard cable marker tags

HLX cable markers are made from zero halogen, low smoke, low toxicity, radiation cross-linked, UV stabilized polyolefin sheet, formed into punched organized cable markers on a paper carrier.

They are used for identification of cables and wire bundles by computer-based printing onto markers. Markers are attached using cable ties. HLX markers are ideal for applications where limited fire hazard characteristics are critical.

Features and benefits

- Recommended for use where combustion of products may endanger personnel or place delicate electronics at risk.
- Several printable heights and widths available.

**Temperature rating**

Operating temperature range -30°C to +105°C -22°F to +221°F

Specifications/approvals

| | |
|----------|---|
| Tyco | RW 2067 |
| Military | SAE AS81531 4.6.2 MIL-STD-202F Method 215J |
| Industry | UL 224 (clause 14) BS 4G 198 Part 3 ASTM D 2671 |

Printer information

| | |
|--------------|--------------------------------------|
| Tyco printer | T312M (thermal transfer) |
| Tyco ribbon | 1910-RIBBON-4T300 (thermal transfer) |

Part numbering system

Ordering information



Available sizes and formats

| Ordering description | Marker dimensions (W X H) | | Printable area (W X H) | | Pack size | |
|----------------------------|---------------------------|----------------------|------------------------|----------------------|-----------|------|
| | mm | <i>inches</i> | mm | <i>inches</i> | NF | TS |
| HLX104<color>1<format>025B | 45.00 x 10.40 | <i>1.800 x 0.400</i> | 25.00 x 10.40 | <i>1.000 x 0.400</i> | 550 | 1000 |
| HLX104<color>1<format>033B | 52.00 x 10.40 | <i>2.100 x 0.400</i> | 33.00 x 10.40 | <i>1.300 x 0.400</i> | 550 | 1000 |
| HLX104<color>1<format>038B | 58.00 x 10.40 | <i>2.300 x 0.400</i> | 38.00 x 10.40 | <i>1.500 x 0.400</i> | 550 | 1000 |
| HLX104<color>1<format>050B | 70.00 x 10.40 | <i>2.750 x 0.400</i> | 50.00 x 10.40 | <i>2.000 x 0.400</i> | 550 | 1000 |
| HLX104<color>1<format>070B | 90.00 x 10.40 | <i>3.500 x 0.400</i> | 70.00 x 10.40 | <i>2.750 x 0.400</i> | 550 | 1000 |
| HLX150<color>1<format>025B | 45.00 x 15.00 | <i>1.800 x 0.600</i> | 25.00 x 15.00 | <i>1.000 x 0.600</i> | 550 | 500 |
| HLX150<color>1<format>033B | 52.00 x 15.00 | <i>2.100 x 0.600</i> | 33.00 x 15.00 | <i>1.300 x 0.600</i> | 550 | 500 |
| HLX150<color>1<format>038B | 58.00 x 15.00 | <i>2.300 x 0.600</i> | 38.00 x 15.00 | <i>1.500 x 0.600</i> | 550 | 500 |
| HLX150<color>1<format>050B | 70.00 x 15.00 | <i>2.750 x 0.600</i> | 50.00 x 15.00 | <i>2.000 x 0.600</i> | 550 | 500 |
| HLX150<color>1<format>070B | 90.00 x 15.00 | <i>3.500 x 0.600</i> | 70.00 x 15.00 | <i>2.750 x 0.600</i> | 550 | 500 |
| HLX203<color>1<format>025B | 45.00 x 20.30 | <i>1.800 x 0.800</i> | 25.00 x 20.30 | <i>1.000 x 0.800</i> | 550 | 500 |
| HLX203<color>1<format>033B | 52.00 x 20.30 | <i>2.100 x 0.800</i> | 33.00 x 20.30 | <i>1.300 x 0.800</i> | 550 | 500 |
| HLX203<color>1<format>038B | 58.00 x 20.30 | <i>2.300 x 0.800</i> | 38.00 x 20.30 | <i>1.500 x 0.800</i> | 550 | 500 |
| HLX203<color>1<format>050B | 70.00 x 20.30 | <i>2.750 x 0.800</i> | 50.00 x 20.30 | <i>2.000 x 0.800</i> | 550 | 500 |
| HLX203<color>1<format>070B | 90.00 x 20.30 | <i>3.500 x 0.800</i> | 70.00 x 20.30 | <i>2.750 x 0.800</i> | 550 | 500 |
| HLX253<color>1<format>025B | 45.00 x 25.30 | <i>1.800 x 1.000</i> | 25.00 x 25.30 | <i>1.000 x 1.000</i> | 300 | 250 |
| HLX253<color>1<format>033B | 52.00 x 25.30 | <i>2.100 x 1.000</i> | 33.00 x 25.30 | <i>1.300 x 1.000</i> | 300 | 250 |
| HLX253<color>1<format>038B | 58.00 x 25.30 | <i>2.300 x 1.000</i> | 38.00 x 25.30 | <i>1.500 x 1.000</i> | 300 | 250 |
| HLX253<color>1<format>050B | 70.00 x 25.30 | <i>2.750 x 1.000</i> | 50.00 x 25.30 | <i>2.000 x 1.000</i> | 300 | 250 |
| HLX253<color>1<format>070B | 90.00 x 25.30 | <i>3.500 x 1.000</i> | 70.00 x 25.30 | <i>2.750 x 1.000</i> | 300 | 250 |

Options

| | | | |
|---------------------------|--|--------------|--------|
| Prescoring | Not available on these products – this should always be 1. | | |
| Package sizes | Standard | B | |
| Colors | Standard | White | Yellow |
| | Code | WE | YW |
| Nonstandard | Red | Blue | |
| | Code | RD | BE |
| Format | NF – Dot matrix printing (fanfold/single sided) | | |
| | TS – Thermal transfer (reel/single sided) | | |
| Printable width on marker | 025 | 25mm (1") | |
| | 033 | 33mm (1.3") | |
| | 038 | 38mm (1.5") | |
| | 050 | 50mm (2") | |
| | 070 | 70mm (2.75") | |

Ordering information: Specify product name, marker height, color, scoring option (always 1), format, printable width, and pack size.

Ordering example: HLX150YW1NF033B

D-SCE Fluid resistant computer-printable permanent wire identification sleeves

D-SCE markers are used to identify wires and cables where exposure to organic fluids, especially oils, is required. D-SCE markers are designed to operate in these conditions at elevated temperatures for extended periods of time, making them ideal in aerospace, rail and construction industries. The D-SCE markers are suitable for use in environments with temperatures of -55°C to $+135^{\circ}\text{C}$ (-67°F to $+275^{\circ}\text{F}$), and will provide strain relief, insulation and protection from mechanical abuse. The 3:1 shrink ratio markers* are assembled in a ladder format enabling sleeves to be printed on both sides for maximum data content and readability.

*See ordering description.

Features and benefits

- Resistance to organic fluids, common fuels, lubricants and solvents.
- 3:1 shrink ratio.
- Wide range of sizes for several wire and bundle diameters.
- Formulated for use in aerospace, rail and construction equipment.
- Dot matrix and thermal transfer printable — both print technologies meet all specifications and approvals listed.



Temperature rating

| | | |
|------------------------------|---|---|
| Operating temperature range | -55°C to $+135^{\circ}\text{C}$ | -67°F to $+275^{\circ}\text{F}$ |
| Minimum recovery temperature | $+135^{\circ}\text{C}$ | $+275^{\circ}\text{F}$ |
| Maximum storage temperature | $+40^{\circ}\text{C}$ | $+104^{\circ}\text{F}$ |

Specifications/approvals

| | |
|----------|--|
| Tyco | RW 2028 |
| Military | SAE-AMS-DTL-23053/6, Class 1 (material and performance requirements) SAE AS81531 4.6.2 MIL-STD-202F Method 215J |
| Industry | NF F 00 608 Category A and H |

Printer information

| | |
|--------------|---|
| Tyco printer | LQ870 (dot matrix) T312M (thermal transfer) |
| Tyco ribbon | TMS-SIX-RIBBON-A (dot matrix) 1950-RIBBON-4T300 (thermal transfer) |

Part numbering system

D-SCE - 5K - 3.2 - 50 - S1 - 4



Ordering information



Available sizes and formats

| Ordering description | D (min) | | d (max) | | Recommended use range |
|------------------------|-------------|-----------------|----------------|-----------------|-----------------------------|
| | As supplied | Inside diameter | After recovery | Inside diameter | |
| | mm | inches | mm | inches | mm inches |
| D-SCE-1K-2.4-50<color> | 2.39 | 0.094 | 0.79 | 0.031 | 0.81 - 1.90 0.032 - 0.075 |
| D-SCE-1K-3.2-50<color> | 3.18 | 0.125 | 1.07 | 0.043 | 1.11 - 2.66 0.044 - 0.105 |
| D-SCE-1K-4.8-50<color> | 4.75 | 0.187 | 1.57 | 0.063 | 1.75 - 4.06 0.069 - 0.160 |
| D-SCE-1K-6.4-50<color> | 6.35 | 0.250 | 2.11 | 0.084 | 2.31 - 5.46 0.091 - 0.215 |
| D-SCE-1K-9.5-50<color> | 9.53 | 0.375 | 3.18 | 0.125 | 3.47 - 8.12 0.137 - 0.320 |
| D-SCE-1K-12-50<color> | 12.70 | 0.500 | 4.22 | 0.167 | 4.64 - 10.79 0.183 - 0.425 |
| D-SCE-1K-18-50<color> | 19.05 | 0.750 | 6.35 | 0.250 | 6.99 - 16.25 0.275 - 0.640 |
| D-SCE-1K-25-50<color> | 25.40 | 1.000 | 8.46 | 0.333 | 9.29 - 21.59 0.366 - 0.850 |
| D-SCE-1K-38-50<color>* | 38.10 | 1.500 | 19.05 | 0.750 | 20.95 - 33.02 0.825 - 1.300 |

* 2:1 shrink ratio

Total width as supplied 90.18 mm (3.550 inches) including tape and carrier width.

Options

| | | | | |
|---------------|---|--|-------------|-------------|
| Prescoring | Perforated score to produce multiple marker sleeves from each D-SCE sleeve. | | | |
| | Standard | Side scored | | |
| | Number of prescores | 1 prescore | 2 prescores | 3 prescores |
| | Code | S1 | S2 | S3 |
| Package sizes | Standard | 1K - 1000 piece packages available for all D-SCE sizes | | |
| | Nonstandard | Larger pack sizes are available. Please contact Tyco. | | |
| Colors | Standard | White | Yellow | |
| | Code | 9 | 4 | |
| | Nonstandard | Pink | Blue | |
| | Code | 2L | 6 | |

Ordering information: Specify product name, pack size, sleeve size, prescore, format and color.

Ordering example: D-SCE-1K-6.4-50-S2-4

NMX Flame retarded polyaramid cable marker tags

NMX cable marker tags are used for identification of cables and wire bundles by computer-based printing onto markers. The markers are attached using cable ties. They are ideal for aerospace and other cases where resistance to harsh environments and light weight are important.

Features and benefits

- Extremely light weight.
- Ultimate tensile strength and tear resistance.
- Flame retardant.
- Resistant to several avionic fluids, solvents and cleaners.
- Dot matrix printable.
- Available in white and yellow printable areas.

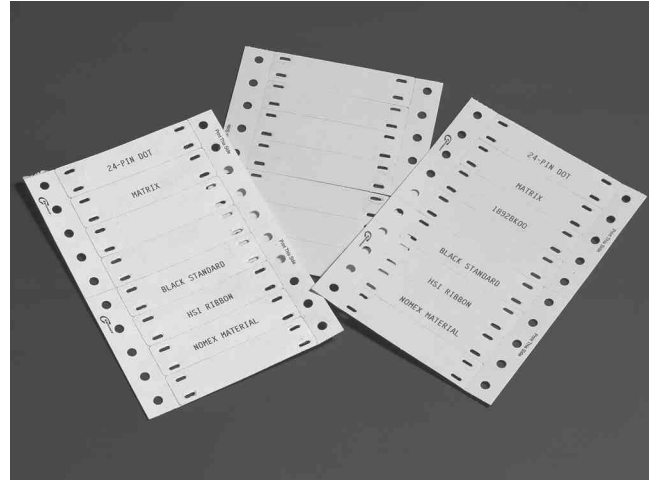

Temperature rating

Operating temperature range -40°C to $+135^{\circ}\text{C}$ -40°F to $+275^{\circ}\text{F}$

Specifications/approvals

| | |
|----------|--|
| Military | SAE AS81531 4.6.2, MIL-STD-202F Method 215J |
| Industry | DMS 2325, DMS 2409 |

Printer information

| | |
|--------------|------------------------|
| Tyco printer | AM6310 (dot matrix) |
| Tyco ribbon | 1892 BK01 (dot matrix) |

Part numbering system

NMX 25625 WE 2.5

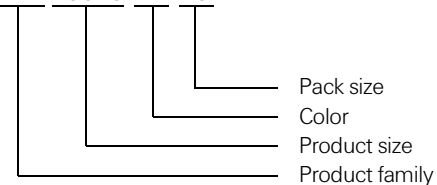

Ordering information

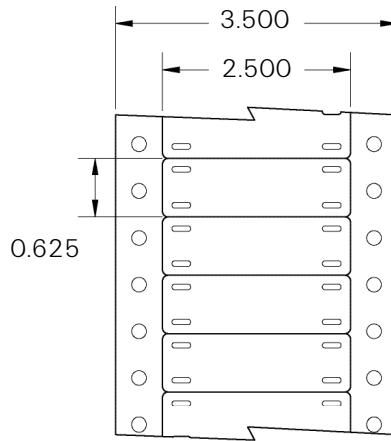

Available sizes and formats

| Ordering description | Label width | | Label height | | Printable width | | Weight (g/10 pcs.) |
|----------------------|-------------|---------------|--------------|---------------|-----------------|---------------|-----------------------|
| | mm | <i>inches</i> | mm | <i>inches</i> | mm | <i>inches</i> | |
| NMX25625<color>2.5 | 63.50 | <i>2.500</i> | 15.87 | <i>0.625</i> | 50.80 | <i>2.000</i> | 2.5 |

Options

| | | |
|---------------|-------------|---|
| Package sizes | Standard | 2500 pieces per pack |
| | Nonstandard | Larger pack sizes are available. Please contact Tyco. |
| Colors | White | Yellow |
| | WE | YE |

Ordering information: Specify product name, product size, color and pack size.

Ordering example: NMX25625WE2.5

RPS Commercial grade wire identification sleeves

RPS markers are heat shrinkable marking sleeves for wire and cable identification. When RPS is printed with Tyco recommended printers and ink ribbons, the marks remain legible, without any post printing process, even when exposed to abrasion, aggressive cleaning solvents, and industrial fluids.

RPS markers are designed to meet the wire identification needs of commercial and industrial customers.

Features and benefits

- Permanent identification sleeves.
- Computer printable.
- Excellent print performance.
- Configured for ease of kitting.
- Good chemical and solvent resistance.
- 3:1 shrink ratio.
- CSA Certified, UL Recognized.

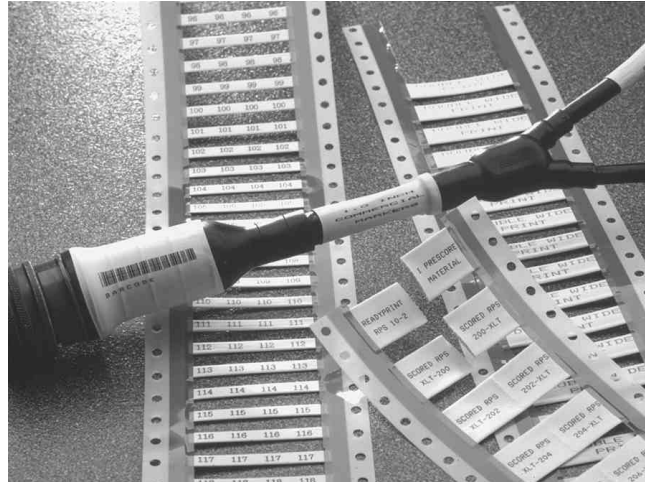

Temperature rating

| | | |
|------------------------------|-----------------|-----------------|
| Operating temperature range | -30°C to +105°C | -22°F to +221°F |
| Minimum recovery temperature | +120°C | +248°F |
| Maximum storage temperature | +40°C | +104°F |

Specifications/approvals

| | |
|----------|---|
| Tyco | RT 1804 |
| Military | SAE AS81531 4.6.2 MIL-STD-202F Method 2 15J |
| Industry | UL Recognized – standard 224, file E35586 CSA Certified – file 31929 |

Printer information

| | |
|--------------|---|
| Tyco printer | LQ870 (dot matrix) T208M (thermal transfer – low volume) T312M (thermal transfer) |
| Tyco ribbon | TMS-SIX-RIBBON-A (dot matrix) TMS-101-RIBBON-4RPSCE (thermal transfer for T208M) TMS-RJS-RIBBON-4RPSCE (thermal transfer for T312M) |

Part numbering system

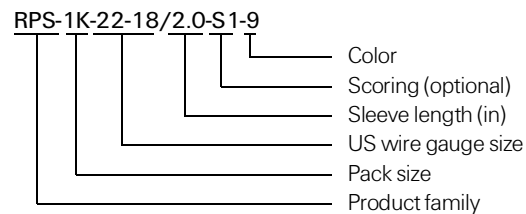

Ordering information



Available sizes and formats

| Ordering description | Inside diameter | | | | Recommended use range | |
|-----------------------------|---------------------|---------------|------------------------|---------------|-----------------------|----------------------|
| | D (min) as supplied | | d (max) after recovery | | | |
| | mm | <i>inches</i> | mm | <i>inches</i> | mm | <i>inches</i> |
| RPS-1K-22-18/2.0-<color> | 3.18 | <i>0.125</i> | 1.07 | <i>0.042</i> | 1.17 - 2.66 | <i>0.046 - 0.105</i> |
| RPS-1K-18-12/2.0-<color> | 4.75 | <i>0.187</i> | 1.57 | <i>0.062</i> | 1.75 - 4.06 | <i>0.069 - 0.160</i> |
| RPS-1K-16-10/2.0-<color> | 6.35 | <i>0.250</i> | 2.11 | <i>0.083</i> | 2.31 - 5.46 | <i>0.091 - 0.215</i> |
| RPS-1K-8-4/2.0-<color> | 9.53 | <i>0.375</i> | 3.18 | <i>0.125</i> | 3.47 - 8.12 | <i>0.137 - 0.320</i> |
| RPS-1K-10-2/2.0-<color> | 12.70 | <i>0.500</i> | 4.22 | <i>0.166</i> | 4.64 - 10.79 | <i>0.183 - 0.425</i> |
| RPS-1K-6-250/2.0-<color> | 19.05 | <i>0.750</i> | 6.35 | <i>0.250</i> | 6.99 - 16.25 | <i>0.275 - 0.640</i> |
| RPS-1K-1-400/2.0-<color> | 25.40 | <i>1.000</i> | 8.46 | <i>0.333</i> | 9.29 - 21.59 | <i>0.366 - 0.850</i> |
| RPS-1K-400-1000/2.0-<color> | 38.10 | <i>1.500</i> | 19.05 | <i>0.750</i> | 20.95 - 33.02 | <i>0.825 - 1.300</i> |

Total width as supplied 90.18 mm (3.550 inches) including tape and carrier width.

Options

| | | | | |
|---------------|---|---|-------------|-------------|
| Prescoring | Perforated score to produce multiple marker sleeves from each RPS sleeve. | | | |
| | Number of prescores | 1 prescore | 2 prescores | 3 prescores |
| | Code | S1 | S2 | S3 |
| Package sizes | Standard | 1K - 1000 piece packs | | |
| | Nonstandard | Smaller and larger pack sizes are available. Please contact Tyco. | | |
| Colors | Standard | White | Yellow | |
| | Code | 9 | 4 | |

Ordering information: Specify product name, pack size, sleeve size, prescore, format and color.

Ordering example: RPS-1K-22-18/2.0-S2-9

NBC-SCE Nuclear, biological & chemical heat shrinkable wire identification sleeves

Tyco NBC-SCE is used to identify wire and cables where extreme resistance to cleaning solvents is needed. The markers are suitable for use in wire harness systems requiring high fluid resistance and resistance to the effects of nuclear, biological and chemical agent exposure and decontamination. The markers should be used with an appropriate transparent oversleeve whose ends are sealed with an appropriate epoxy adhesive.

NBC-SCE marker sleeves are suitable for use in environments with temperatures from -55°C to $+225^{\circ}\text{C}$ (-67°F to $+275^{\circ}\text{F}$).

Features and benefits

- Permanent identification sleeves.
- Computer-printable.
- 2:1 shrink ratio.
- NBC application with the appropriate adhesive and oversleeve.

**Temperature rating**

| | | |
|------------------------------|---|---|
| Operating temperature range | -55°C to $+225^{\circ}\text{C}$ | -67°F to $+437^{\circ}\text{F}$ |
| Minimum recovery temperature | $+200^{\circ}\text{C}$ | $+392^{\circ}\text{F}$ |
| Maximum storage temperature | $+40^{\circ}\text{C}$ | $+104^{\circ}\text{F}$ |

Specifications/approvals

| | |
|----------|---|
| Tyco | RT 1809, RT 700 |
| Military | SAE AS81531 4.6.2 MIL-STD-202F Method 215J |

Printer information

| | |
|--------------|---------------------------------------|
| Tyco printer | T3 12M (thermal transfer) |
| Tyco ribbon | TMS-RJS-RIBBON-4HT (thermal transfer) |

Part numbering systemNBC-SCE-1K- $\frac{1}{4}$ -2.0-S1-9

Ordering information

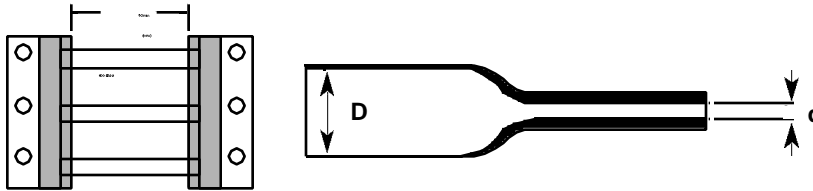

Available sizes and formats

| Ordering description | Inside diameter | | | | Recommended use range | | Recovered wall thickness | |
|-----------------------------|----------------------|--------|-----------------------|--------|-----------------------|-------------|--------------------------|---------------|
| | Expanded D (minimum) | | Recovered d (maximum) | | | | | |
| | mm | inches | mm | inches | mm | inches | mm | inches |
| NBC-SCE-1K-1/8-2.0<color> | 3.43 | 0.135 | 1.59 | 0.062 | 1.75-2.66 | 0.069-0.105 | 0.38 ± 0.08 | 0.015 ± 0.003 |
| NBC-SCE-1K-1/4-2.0<color> | 6.35 | 0.250 | 3.18 | 0.125 | 3.81-5.46 | 0.150-0.215 | 0.38 ± 0.08 | 0.015 ± 0.003 |
| NBC-SCE-1K-1/2-2.0<color> | 12.70 | 0.500 | 6.35 | 0.250 | 6.99-10.79 | 0.275-0.425 | 0.38 ± 0.08 | 0.015 ± 0.003 |
| NBC-SCE-1K-3/4-2.0<color> | 19.05 | 0.750 | 9.53 | 0.375 | 10.16-16.25 | 0.400-0.640 | 0.38 ± 0.08 | 0.015 ± 0.003 |
| NBC-SCE-1K-1-2.0<color> | 25.40 | 1.000 | 12.70 | 0.500 | 14.70-21.50 | 0.578-0.846 | 0.43 ± 0.10 | 0.017 ± 0.004 |
| NBC-SCE-1K-1-1/2-2.0<color> | 38.10 | 1.500 | 19.05 | 0.750 | 20.95-33.02 | 0.825-1.300 | 0.43 ± 0.10 | 0.017 ± 0.004 |

Total width as supplied 90.18 mm (3.550 inches) including tape and carrier width.

Options

| | | | |
|---------------|---|---|-------------|
| Prescoring | Perforated score to produce multiple marker sleeves from each NBC-SCE sleeve. | | |
| | Number of prescores | 1 prescore | 2 prescores |
| | Code | S1 | S2 |
| | | | 3 prescores |
| | | | S3 |
| Package sizes | Standard | 1000 piece packages available for all NBC-SCE sizes | |
| Colors | Standard | White | |
| | Code | 9 | |

Ordering information: Please specify product name, pack size, sleeve size, prescore, format and color.

Ordering example: NBC-SCE-1K-1/8-2.0-9

TMS-CCUV Heat shrinkable UV protection sleeves

TMS-CCUV clear heat shrinkable sleeves are designed for over protection of TMS System Six identification products, to give increased protection for permanent, long-term environmental exposure. The clear CCUV heat-shrinkable sleeves are formulated to combine a long-term barrier to the effects of ultra-violet, with tough resistance to abrasion and industrial fluids. They are available in packs which match the product sizes and pack quantities of TMS System Six heat-shrinkable identification sleeves and cable markers.

The TMS CCUV sleeves are inherently low profile and use the action of heat-shrink to lock in place over the previously installed identification sleeves; except for cable markers which use a slide fitting CCUV sleeve which is held in place by the cable ties.

The action of heat-shrink locking of the CCUV sleeves means there is no reliance on the long term performance of adhesives to hold the outer protection layer in place, and also gives the ability to accommodate cables and wire bundles which may be bent or flexed during use.

Features and benefits

- Exceptional clarity and stability.
- Added UV-resistant sleeves.
- Not printable.
- Tough resistance to abrasion and industrial fluids.
- Heat-shrink locking in place (no reliance on adhesives).
- Low profile.
- Accommodates bent or flexing cable/wire bundles.
- Can work as an NBC (nuclear, biological, chemical) System with NBC-SCE sleeves and appropriate adhesive.



Ordering information



Temperature rating

| | | |
|------------------------------|-----------------|----------------|
| Operating temperature range | -55°C to +150°C | -67°F to 302°F |
| Minimum recovery temperature | +150°C | +302°F |
| Maximum storage temperature | +40°C | +104°F |

Specifications/approvals

| | |
|----------|--|
| Tyco | RW 2027 |
| Military | UL VW-1 rated SAE-AMS-DTL-23053/18, Class 2 |

Part numbering system

TMS-CCUV-SLEEVE-1-X-65mm

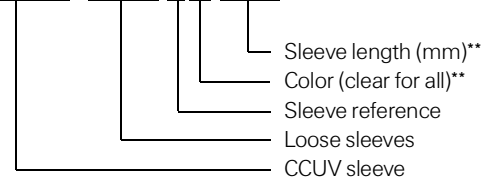

** not used in NBC-SCE 76mm (3") length sleeve options

Available sizes and formats

(For use with heat shrink sleeves)

| Ordering description | Sleeve length | | Inside diameter minimum | | Recovered diameter maximum | | Wire size diameter | | Sleeve size expanded diameter | |
|--------------------------|---------------|--------|-------------------------|--------|----------------------------|-------------|--------------------|--------|-------------------------------|----------|
| | mm | inches | mm | inches | mm | inches | mm | inches | TMS-SCE | RPS |
| TMS-CCUV-SLEEVE-1-X-65mm | 65 | 3.20 | 0.125 | 1.60 | 0.063 | 1.80-2.80 | 0.071-0.110 | 2.40 | 0.094 | N/A |
| TMS-CCUV-SLEEVE-1-X-65mm | 65 | 3.20 | 0.125 | 1.60 | 0.063 | 1.80-2.80 | 0.071-0.110 | 3.20 | 0.125 | 22-18 |
| TMS-CCUV-SLEEVE-2-X-65mm | 65 | 4.80 | 0.187 | 2.40 | 0.094 | 2.60-3.70 | 0.102-0.146 | 4.80 | 0.188 | 18-12 |
| TMS-CCUV-SLEEVE-2-X-65mm | 65 | 4.80 | 0.187 | 2.40 | 0.094 | 2.60-3.70 | 0.102-0.146 | 6.40 | 0.250 | 16-10 |
| TMS-CCUV-SLEEVE-3-X-65mm | 65 | 6.40 | 0.250 | 3.20 | 0.126 | 3.50-5.10 | 0.138-0.201 | 9.50 | 0.375 | 8-4 |
| TMS-CCUV-SLEEVE-4-X-65mm | 65 | 9.50 | 0.375 | 4.80 | 0.189 | 5.00-7.00 | 0.197-0.275 | 12.70 | 0.500 | 10-2 |
| TMS-CCUV-SLEEVE-5-X-65mm | 65 | 12.70 | 0.500 | 6.40 | 0.252 | 6.90-10.60 | 0.272-0.417 | 19.00 | 0.750 | 6-250 |
| TMS-CCUV-SLEEVE-6-X-65mm | 65 | 19.00 | 0.750 | 9.50 | 0.374 | 10.00-14.00 | 0.394-0.551 | 25.40 | 1.000 | 1-400 |
| TMS-CCUV-SLEEVE-7-X-65mm | 65 | 25.40 | 1.000 | 12.70 | 0.500 | 13.30-21.00 | 0.524-0.827 | 25.40 | 1.000 | 1-400 |
| TMS-CCUV-SLEEVE-8-X-65mm | 65 | 38.10 | 1.500 | 19.00 | 0.748 | 21.00-33.80 | 0.827-1.331 | 38.10 | 1.500 | 400-1000 |

Some TMS-SCE and RPS sleeve sizes may need to be recovered partially before CCUV sleeve is applied to protect them.

(For use with cable markers to secure / protect without cable ties)

| Ordering description | Sleeve length | Inside diameter minimum | | Recovered diameter maximum | | Wire size diameter | | Marker height | |
|--------------------------|---------------|-------------------------|--------|----------------------------|--------|--------------------|-------------|---------------|--------|
| | | mm | inches | mm | inches | mm | inches | mm | inches |
| TMS-CCUV-SLEEVE-4-X-65mm | 65 | 9.50 | 0.375 | 4.80 | 0.189 | 5.00-8.00 | 0.197-0.315 | 6.40 | 0.250 |
| TMS-CCUV-SLEEVE-5-X-65mm | 65 | 12.70 | 0.500 | 6.40 | 0.252 | 7.00-11.00 | 0.275-0.433 | 6.40 | 0.250 |
| TMS-CCUV-SLEEVE-6-X-65mm | 65 | 19.00 | 0.750 | 9.50 | 0.374 | 12.00-17.00 | 0.472-0.669 | 12.70 | 0.500 |
| TMS-CCUV-SLEEVE-7-X-65mm | 65 | 25.40 | 1.000 | 12.70 | 0.500 | 15.00-23.00 | 0.590-0.905 | 12.70 | 0.500 |

(For use with cable markers to protect with cable ties)

| Ordering description | Sleeve length | Inside diameter minimum | | Recovered diameter maximum | | Wire size diameter | | Marker height | |
|---------------------------|---------------|-------------------------|--------|----------------------------|--------|--------------------|--------|---------------|--------|
| | | mm | inches | mm | inches | mm | inches | mm | inches |
| TMS-CCUV-SLEEVE-9-X-32mm | 32 | 6.40 | 0.250 | 3.20 | 0.126 | N/A | | 6.40 | 0.250 |
| TMS-CCUV-SLEEVE-10-X-32mm | 32 | 12.70 | 0.500 | 6.40 | 0.252 | N/A | | 12.70 | 0.500 |

(For use with NBC-SCE sleeves and adhesives sealing)*

| Ordering description | Sleeve length | Inside diameter minimum | | Recovered diameter maximum | | Wire size diameter NBC-SCE | | Sleeve size expanded diameter NBC-SCE | |
|----------------------|---------------|-------------------------|--------|----------------------------|--------|----------------------------|-------------|---------------------------------------|--------|
| | | mm | inches | mm | inches | mm | inches | mm | inches |
| TMS-CCUV-SLEEVE-15 | 76 | 3.20 | 0.125 | 1.60 | 0.063 | 1.80-2.80 | 0.071-0.110 | 3.20 | 0.125 |
| TMS-CCUV-SLEEVE-16 | 76 | 4.80 | 0.187 | 2.40 | 0.094 | 2.60-3.70 | 0.102-0.146 | 4.80 | 0.188 |
| TMS-CCUV-SLEEVE-17 | 76 | 6.40 | 0.250 | 3.20 | 0.126 | 3.50-5.10 | 0.138-0.201 | 6.40 | 0.250 |
| TMS-CCUV-SLEEVE-18 | 76 | 9.50 | 0.375 | 4.80 | 0.189 | 5.00-7.00 | 0.197-0.275 | 9.50 | 0.375 |
| TMS-CCUV-SLEEVE-19 | 76 | 12.70 | 0.500 | 6.40 | 0.252 | 6.90-10.60 | 0.272-0.417 | 12.70 | 0.500 |
| TMS-CCUV-SLEEVE-20 | 76 | 19.00 | 0.750 | 9.50 | 0.374 | 10.00-14.00 | 0.394-0.551 | 19.00 | 0.750 |
| TMS-CCUV-SLEEVE-21 | 76 | 25.40 | 1.000 | 12.70 | 0.500 | 13.30-21.00 | 0.524-0.827 | 25.40 | 1.000 |
| TMS-CCUV-SLEEVE-22 | 76 | 38.10 | 1.500 | 19.00 | 0.748 | 21.00-33.80 | 0.827-1.331 | 38.10 | 1.500 |

**For use with adhesives such as S-1255-04 and S-1264 please refer to RT1012 and RT1014 for specifications and adhesive details.*

Options

| | | |
|-----------------------|--|---------------------|
| Prescoring | Not available – supplied as cut pieces. | |
| Package Sizes | Standard | 250 piece bags only |
| Colors | Standard | Clear only |
| Ordering information: | Specify product name, loose sleeve, sleeve reference, color and sleeve length. | |
| Ordering example: | For all Heat Shrink sleeves except NBC-SCE TMS-CCUV-SLEEVE-1-X- 65mm For NBC-SCE TMS-CCUV-SLEEVE-22 | |

tyco**Electronics**

Performance Labels

VF/NPVF/VF-130 Tedlar® color coding tape and labels

This polyvinyl fluoride material is designed for use as a wire/cable marker, label and wrap-around in the general aviation industry. The product is ideal for a variety of harsh chemical environments and where non-igniting/self-extinguishing properties are a necessity. It is available in several application-defined types and sizes and can be used with various printing technologies.

VF series

The VF series of Tedlar® products is specifically designed for wire/cable labeling. The product is dot matrix or thermal transfer printable and is available in several continuous and die-cut formats to fit a wide range of cables/cable bundles. The product meets all the requirements of the BMS 13-47, DMS 2359 and GAT 100BA specifications, the benchmarks for pressure-sensitive wrap-around labels in the aerospace industry.

NPVF Series

The NPVF Tedlar® is a non-printable, 12.7mm (½ in) wide and 30.48m (100 ft) long continuous tape designed for use as a color-coded identifier for cables/cable bundles. Besides identifying the bundle this product is wrapped around, it also provides strength and rigidity to the bundle. The product has all the features of the VF series of Tedlar® products except for printability.

VF-130 Series

The VF-130 series is a range of clear non-printable Tedlar® tapes designed for use as an over laminate on wires/bundle identifiers where additional UV protection is required. These tapes can be used over various types of identifiers like wrap around labels, heat-shrink labels, tie-on cable labels and pressure-sensitive markers.

Features and benefits

- Resists water, oil, conventional cleaning agents, and oil based solvents.
- Filters UV light.
- Exhibits high degree of resistance to aging.
- Meets the requirements of MIL-M-87958.
- Available in several colors to facilitate color-coding and clear for over laminating.

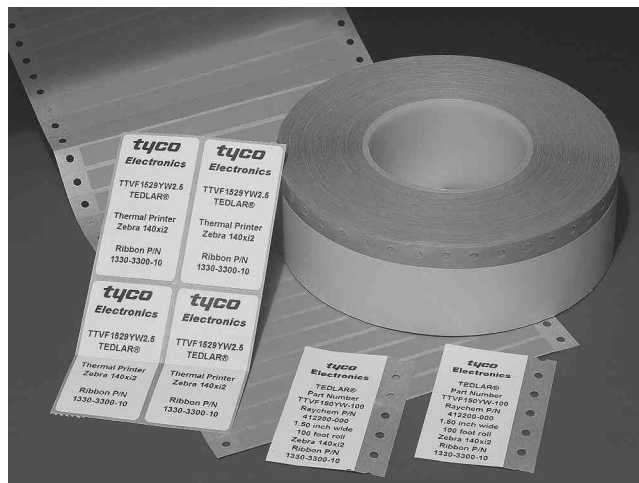
**Temperature rating**

| | | |
|-----------------------------|-----------------|-----------------|
| Operating temperature range | | |
| VF and NPVF | -40°C to +130°C | -40°F to +266°F |
| VF-130 | -40°C to +105°C | -40°F to +221°F |
| VF-130 | -40°C to 105°C | -40°F to 221°F |

Specifications/approvals

| | |
|----------|-------------|
| Military | MIL-M-87958 |
| | DMS 2359 |
| Industry | BMS-13-47 |
| | BACT 19 |
| | GAT100BA |

Printer information

| | |
|--------------|---|
| Tyco printer | AM6310 (dot matrix) T308S* (thermal transfer) |
| | *Size dependent. Contact Tyco. |
| Tyco ribbon | 1892BK01 (dot matrix) 1330-3300-10* (thermal transfer) |
| | *Alternative printers and ribbons are available for special applications. Contact Tyco Electronics Identification for more information. |

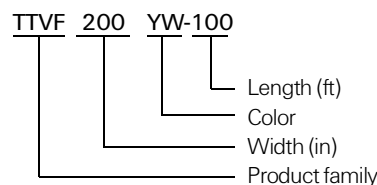
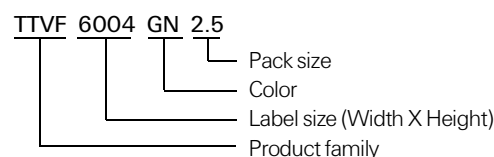
Part numbering system (Continuous)**Part numbering system (Die-Cut)**

Ordering information



Polyvinyl Fluoride VF Tedlar® – Continuous Labels

| Ordering description | Printer type | Label width mm inches | Label length M FT | Quantity per pack |
|--------------------------|--------------|--------------------------|----------------------|-------------------|
| <format>VF050<color>-180 | DM/TT | 12.70 0.500 | 54.86 180 | Continuous |
| <format>VF075<color>-100 | DM/TT | 19.05 0.750 | 30.48 100 | Continuous |
| <format>VF100<color>-100 | DM/TT | 25.40 1.000 | 30.48 100 | Continuous |
| <format>VF150<color>-100 | DM/TT | 38.10 1.500 | 30.48 100 | Continuous |
| <format>VF200<color>-100 | DM/TT | 50.80 2.000 | 30.48 100 | Continuous |
| <format>VF300<color>-100 | DM/TT | 76.20 3.000 | 30.48 100 | Continuous |
| <format>VF400<color>-100 | DM/TT | 101.60 4.000 | 30.48 100 | Continuous |

Polyvinyl Fluoride VF Tedlar® – Die-Cut Labels

| Ordering description | Printer type | Label width mm inches | Label height mm inches | Quantity per pack |
|--------------------------|--------------|--------------------------|---------------------------|-------------------|
| <format>VF1029<color>2.5 | DM/TT | 25.40 1.000 | 73.66 2.900 | 2500 |
| <format>VF1079<color>1 | DM/TT | 25.40 1.000 | 200.66 7.900 | 1000 |
| <format>VF1529<color>2.5 | DM/TT | 38.10 1.500 | 73.66 2.900 | 2500 |
| <format>VF1679<color>1 | DM/TT | 40.64 1.600 | 200.66 7.900 | 1000 |
| <format>VF3015<color>1 | DM/TT | 76.20 3.000 | 38.10 1.500 | 1000 |
| <format>VF3509<color>2.5 | DM/TT | 88.90 3.500 | 22.86 0.900 | 2500 |
| <format>VF6004<color>2.5 | DM/TT | 152.40 6.000 | 10.16 0.400 | 2500 |

Options

| | | | | | | | |
|--------|---------------------------------|-------|-----|------|-------|--------|------|
| Format | (TT) Thermal transfer printable | | | | | | |
| | (DM) Dot matrix printable | | | | | | |
| Colors | Yellow | White | Red | Blue | Green | Violet | Pink |
| Code | YW | WE | RD | BE | GN | VT | PK |

Polyvinyl Fluoride NPVF Tedlar® – Color coding tape

| Ordering description | Printer type | Roll width mm inches | Label length M FT | Quantity per pack |
|----------------------|--------------|-------------------------|----------------------|-------------------|
| NPVF050XX-100 | N/A | 12.70 0.500 | 30.48 100 | Continuous |

Options

| | | | | | | | | | | | | |
|--------|--------|-------|-----|------|-------|--------|------|-------|-------|--------|------|------|
| Colors | Yellow | White | Red | Blue | Green | Violet | Pink | Black | Brown | Orange | Grey | Gold |
| Code | YW | WE | RD | BE | GN | VT | PK | BK | BN | OE | GY | GD |

Polyvinyl Fluoride VF-130 Tedlar® – Over laminate tapes

| Ordering description | Printer type | Color | Label width mm inches | Label length M FT | Quantity per pack |
|----------------------|--------------|-------|--------------------------|----------------------|-------------------|
| NPVF150CL-100 | N/A | Clear | 38.10 1.500 | 30.48 100 | Continuous |
| NPVF200CL-100 | N/A | Clear | 50.80 2.000 | 30.48 100 | Continuous |
| NPVF300CL-100 | N/A | Clear | 76.20 3.000 | 30.48 100 | Continuous |
| NPVF400CL-100 | N/A | Clear | 101.60 4.000 | 30.48 100 | Continuous |

RMK-6 Computer printable epoxy coated labels

RMK-6 is a computer printable labelstock with outstanding fluid and abrasion resistance, designed to be printed by impact dot matrix printers. When heat-cured after printing, its unique heat reactive epoxy surface "locks in" the image to combine the versatility and convenience of on-site printing with performance to meet the toughest conditions. A high performance acrylic adhesive ensures simple installation while maintaining excellent adhesion.

Typical applications are rating plate labels, component identification, and pipe and cable wraparound markers. Outdoor use is not recommended.

Features and benefits

- Printable by dot matrix printers.
- Excellent fluid and abrasion resistance without an overlay.
- High performance acrylic adhesive.
- Low fire hazard properties.
- Indoor use only.

Temperature rating
Operating temperature range

| | | |
|----------------|-----------------|-----------------|
| Wiring marking | -40°C to +85°C | -40°F to +185°F |
| Panel marking | -40°C to +105°C | -40°F to +221°F |

Excursion temperature +200°C for 2 hours

| | | |
|--------------------|----------|--|
| Storage conditions | Unopened | 12 months at temperatures not exceeding +35°C (+95°F). |
| | Opened | 6 months at temperatures not exceeding +25°C (+77°F) and 80% relative humidity |

Curing 4 - 6 minutes at 160°C in an air circulating oven.

Specifications/approvals

| | | |
|----------|----|---------------------|
| Tyco | | RK 6648 |
| Industry | UL | MH17259 Group PGGU2 |

Printer information

| | |
|--------------|-----------------------|
| Tyco printer | AM6310 (dot matrix) |
| Tyco ribbon | 1892BK04 (dot matrix) |

Part numbering system

RMK6 - 8.5

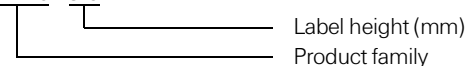

RMK-6 Computer printable epoxy coated labels (Cont'd)

Ordering information



Available sizes and formats

| Ordering description | Label height | Label width | Package quantity |
|----------------------|--------------|-------------|------------------|
| | mm | mm | Labels per pack |
| RMK6-4.2 | 4.20 | 50.80 | 10000 |
| RMK6-8.5 | 8.50 | 50.80 | 5000 |
| RMK6-12.7 | 12.70 | 50.80 | 3000 |
| RMK6-17.0 | 17.00 | 50.80 | 2500 |
| RMK6-25.4 | 25.40 | 50.80 | 1500 |
| RMK6-55.0 | 55.00 | 50.80 | 750 |
| RMK6-WM* | * | 50.80 | * |

*An uncut version for wraparound markers. Spool length = 40 meters.

Options

| Colors | Standard | White |
|--------|----------|-------|
|--------|----------|-------|

tyco**Electronics**

Performance Labels

RMK Computer printable epoxy coated labels in a sheet form

RMK is a computer printable labelstock with outstanding fluid and abrasion resistance, designed to be printed by sheet fed inkjet printers. When heat-cured after printing its unique heat reactive epoxy surface "locks in" the image to combine the versatility and convenience of on-site printing with performance to meet the toughest conditions. A high performance acrylic adhesive ensures simple installation while maintaining excellent adhesion. A wide range of label sizes are available, supplied in A4 sheets for feeding through standard inkjet printers.

Typical applications are replacement of engraved metal or plastic labels, signs and tallies rating plate labels and color coding.

Features and benefits

- High performance label material.
- High performance acrylic adhesive.
- A4 format sheet.
- Printable by color inkjet printers with sheet feed.
- Outstanding fluid and abrasion resistance without an overlay.
- Low fire hazard properties.
- Indoor use only.

**Temperature rating**

Operating temperature range

| | | |
|----------------|-----------------|-----------------|
| Wiring marking | -40°C to +85°C | -40°F to +185°F |
| Panel marking | -40°C to +105°C | -40°F to +221°F |

Excursion temperature

+200°C for 2 hours

Storage conditions

Unopened
12 months at temperatures not exceeding +35°C (+95°F)Opened
6 months at temperatures not exceeding +25°C (+77°F)
and 80% relative humidity

Curing

4-6 minutes at 160°C
in an air circulating oven.**Specifications/approvals**

| | |
|------|---------|
| Tyco | RK 6648 |
|------|---------|

Printer information

Various color inkjet printers can be used depending on the application.

Tyco recommended printer HP-900 Series

For further advice on possible alternative printers, contact Tyco.

Part numbering system

RMK-18x35-A4

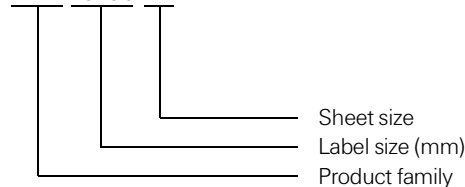

RMK Computer printable epoxy coated labels in a sheet form (Cont'd)

Ordering information



A4 sheet dimensions



Label dimensions

Available sizes and formats

| Ordering description | Label height mm | Label width mm | Labels per sheet |
|----------------------|--------------------|-------------------|------------------|
| RMK-9x25-A4 | 9 | 25 | 132 |
| RMK-10x19-A4 | 10 | 19 | 160 |
| RMK-11x40-A4 | 11 | 40 | 72 |
| RMK-18x20-A4 | 18 | 20 | 96 |
| RMK-18x25-A4 | 18 | 25 | 72 |
| RMK-18x35-A4 | 18 | 35 | 48 |
| RMK-18x50-A4 | 18 | 50 | 36 |
| RMK-25x30-A4 | 25 | 30 | 45 |
| RMK-25x35-A4 | 25 | 35 | 36 |
| RMK-25x50-A4 | 25 | 50 | 27 |
| RMK-25x75-A4 | 25 | 75 | 18 |
| RMK-25x100-A4 | 25 | 100 | 10 |
| RMK-28x40-A4 | 28 | 40 | 32 |
| RMK-30x13-A4 | 30 | 13 | 88 |
| RMK-35x75-A4 | 35 | 75 | 12 |
| RMK-50x13-A4 | 50 | 13 | 50 |
| RMK-50x25-A4 | 50 | 25 | 30 |
| RMK-50x100-A4 | 50 | 100 | 5 |
| RMK-75x150-A4 | 75 | 150 | 3 |
| RMK-87x13-A4 | 87 | 13 | 33 |
| RMK-87x25-A4 | 87 | 25 | 18 |
| RMK-150x150-A4 | 150 | 150 | 1 |
| RMK-170x13-A4 | 170 | 13 | 11 |
| RMK-170x25-A4 | 170 | 25 | 6 |
| RMK-190x30-A4 | 190 | 30 | 5 |
| RMK-200x13-A4 | 200 | 13 | 10 |
| RMK-250x13-A4 | 250 | 13 | 11 |
| RMK-250x25-A4 | 250 | 25 | 6 |
| RMK-UNCUT-A4 | Uncut | | 50 sheets |

Options

| | | |
|--------------|----------|-----------|
| Package size | Standard | 50 sheets |
| Color | Standard | White |

TTP Continuous polyester for decals

The system is designed for applications that require a high-durability label with all the features of a "silk-screened" label, only without the cost, time and inflexibility involved in obtaining a silk-screened product. The product utilizes high performance polyester with permanent acrylic adhesive. It is thermal transfer printable with all the capabilities of graphics, barcodes, logos and several fonts. The product is available in several colors although white, clear and metalized silver are available as standard. Typical applications include panel labels, fascias, decalcomanias and asset identification and rating plates. Typical industry use includes aerospace, defense, electronics and infrastructure.

Features and benefits

- Efficient solution for expensive silk-screen printing.
- Available in continuous format.
- Several widths and colors available.
- Interior and exterior aircraft use including flight entertainment and deck instrumentation.
- Thermal transfer printable.
- Printable in any combination of material and ribbon colors.



Temperature rating

Operating temperature range

| | | |
|--------------------------------|-----------------|-----------------|
| Clear | -40°C to +125°C | -40°F to +257°F |
| White, metalized and colors | -29°C to +150°C | -20°F to +302°F |

Specifications/approvals

| | |
|----------|---|
| Military | MIL-P-38477A (Salt spray) A-A-59485 (accelerated weather resistance and salt spray) |
| Industry | GAT 100BB |

Printer information

| | |
|--------------|---------------------------------|
| Tyco printer | T312S (thermal transfer) |
| Tyco ribbon | 1330-3300-10 (thermal transfer) |

Part numbering system

TTP 200 CL-10



Ordering information



Available sizes and formats

| Ordering description | Label width | | Roll length | | Quantity per pack |
|----------------------|-------------|---------------|-------------|-------------|-------------------|
| | mm | <i>inches</i> | meters | <i>feet</i> | |
| TTP200<color>-10 | 50.80 | <i>2.000</i> | 30.48 | <i>100</i> | Continuous |
| TTP300<color>-10 | 76.20 | <i>3.000</i> | 30.48 | <i>100</i> | Continuous |
| TTP400<color>-10 | 101.60 | <i>4.000</i> | 30.48 | <i>100</i> | Continuous |
| TTP600<color>-10 | 152.40 | <i>6.000</i> | 30.48 | <i>100</i> | Continuous |

Options

| | | | | | | | |
|--------|--------------|-------|-------|------------------|--------|-------|--------|
| Colors | Standard | Clear | White | Metalized silver | | | |
| | Code | CL | WE | MP | | | |
| | Non Standard | Red | Green | Blue | Orange | Black | Yellow |
| | Code | RD | GN | BE | OE | BK | YW |

Ordering example: TTP300GN-10



Electronics

Performance Labels

HPK Thermal transfer printable panel labels

Tyco HPK is a semi-rigid, heavy gauge polypropylene film with a permanent acrylic adhesive, designed to permanently identify control panel components and racks, as well as general labeling applications that require a high performance heavy gauge material. They offer excellent abrasion resistance, and adhere to most smooth surfaces including bare and painted metal.

For guaranteed print performance and durability, use with Tyco's RHD series ribbon.

Features and benefits

- Self-adhesive backing for quick and easy fixing.
- Thermal transfer printable.
- Recommended for indoor use.
- Resistant to common fluids, lubricants and solvents.

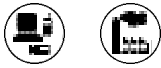

Temperature rating

| | | |
|------------------------------|----------------|-----------------|
| Operating temperature range | -29°C to +80°C | -24°F to +176°F |
| Minimum recovery temperature | 10°C | +50°F |

Printer information

| | |
|--------------|---------------------------------|
| Tyco printer | T308S (thermal transfer) |
| Tyco ribbon | 1330-0607-10 (thermal transfer) |

Part numbering system

HPK 02 WE 1 050



HPK Thermal transfer printable panel labels (Cont'd)

Ordering information



Available sizes and formats

| Ordering description | Labels across | (A) Label width | | (B) Label height | | (C) Vertical repeat | | (D) Web width | |
|----------------------|---------------|-----------------|---------------|------------------|---------------|---------------------|---------------|---------------|---------------|
| | | mm | <i>inches</i> | mm | <i>inches</i> | mm | <i>inches</i> | mm | <i>inches</i> |
| HPK02WE1050 | 1 | 50.80 | <i>2.000</i> | 5.10 | <i>0.200</i> | 8.30 | <i>0.325</i> | 57.20 | <i>2.250</i> |
| HPK04WE1050 | 1 | 50.80 | <i>2.000</i> | 10.20 | <i>0.400</i> | 13.30 | <i>0.525</i> | 57.20 | <i>2.250</i> |
| HPK06WE1050 | 1 | 50.80 | <i>2.000</i> | 15.20 | <i>0.600</i> | 18.40 | <i>0.725</i> | 57.20 | <i>2.250</i> |
| HPK08WE1050 | 1 | 50.80 | <i>2.000</i> | 20.30 | <i>0.800</i> | 23.50 | <i>0.925</i> | 57.20 | <i>2.250</i> |
| HPK10WE1050 | 1 | 50.80 | <i>2.000</i> | 25.40 | <i>1.000</i> | 28.60 | <i>1.125</i> | 57.20 | <i>2.250</i> |

Options

| | | | |
|---------------------|--|-----------------|--|
| Prescoring | Perforated score to produce multiple labels from each HPK label. | | |
| Number of prescores | 0 prescores | 1 prescore | |
| Code | 1 | 2 | |
| Package size | Standard | 1000 piece pack | |
| Color | Standard | White | |

Ordering information: Specify product name, product size and prescores.

Ordering example: HPK02WE1050

tyco**Electronics**

Performance Labels

HPC Dot matrix printable panel labels

Tyco HPC is a semi-rigid, heavy gauge specially formulated fabric material with a high tack permanent acrylic adhesive that is designed to permanently identify control panel components and racks, as well as general labeling applications that require a high performance, heavy gauge material. It has excellent abrasion resistance and adheres to most smooth surfaces including bare and painted metal.

For guaranteed print performance and durability, use with Tyco's RI Quick Dry series ribbon.

Features and benefits

- Specially formulated fabric material.
- Dot matrix printable.
- Print performance exceeds military specs.
- High performance acrylic adhesive.
- Single score option available.

**Temperature rating**

Operating temperature range -54°C to +71°C -65°F to +160°F

Specifications/approvals

Military SAE AS8153 1 4.6.2
MIL-STD-202F method 215J

Printer information

Tyco printer AM63 10* (dot matrix)
Tyco ribbon 1892BK01* (dot matrix)

**Alternate printers and ribbons available for special applications. Contact Tyco Electronics Identification for more information.*

Part numbering system

HPC 02 WE 1 050

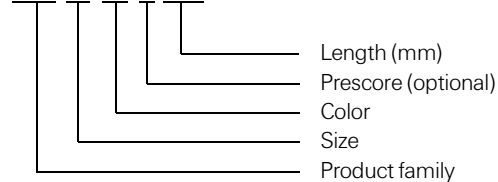

HPC Dot matrix printable panel labels (Cont'd)

Ordering information



Available sizes and formats

| Ordering description | Number of labels across | (A) Label width | | (B) Label height | | (C) Vertical repeat | | (D) Web width | |
|----------------------|-------------------------|-----------------|---------------|------------------|---------------|---------------------|---------------|---------------|---------------|
| | | mm | <i>inches</i> | mm | <i>inches</i> | mm | <i>inches</i> | mm | <i>inches</i> |
| HPC02WE1050 | 1 | 50.80 | <i>2.000</i> | 5.10 | <i>0.200</i> | 5.10 | <i>0.200</i> | 76.20 | <i>3.000</i> |
| HPC04WE1050 | 1 | 50.80 | <i>2.000</i> | 10.20 | <i>0.400</i> | 10.20 | <i>0.400</i> | 76.20 | <i>3.000</i> |
| HPC06WE1050 | 1 | 50.80 | <i>2.000</i> | 15.20 | <i>0.600</i> | 15.20 | <i>0.600</i> | 76.20 | <i>3.000</i> |
| HPC08WE1050 | 1 | 50.80 | <i>2.000</i> | 20.30 | <i>0.800</i> | 20.30 | <i>0.800</i> | 76.20 | <i>3.000</i> |
| HPC10WE1050 | 1 | 50.80 | <i>2.000</i> | 25.40 | <i>1.000</i> | 25.40 | <i>1.000</i> | 76.20 | <i>3.000</i> |

Options

| | | | | |
|---------------|--|--------------------------------|------------|--|
| Prescoring | Perforated score to produce multiple labels from each HPC label. | | | |
| Standard | Number of prescores | 0 prescores | 1 prescore | |
| | Labels per 2" width | 1 | 2 | |
| | Code | 1 | 2 | |
| Package sizes | Standard | 1000 piece packages available. | | |
| Colors | Standard | White | | |

Ordering information: Specify product name, size, color, prescore and length.

Ordering example: HPC02WE1050

SB Thermal transfer printable self-laminating labels

Tyco SB is a thermal transfer printable, translucent vinyl film with a permanent acrylic adhesive, supplied with a white printable area, which is over-laminated upon application with the translucent portion of the label. This 'self-laminating' feature protects the printed area from exposure to oil, solvents, water and abrasion. SB labels offer excellent conformability to round, irregular or flexible surfaces. Ideal for wire and cable identification, including flat ribbon cables that are subject to repeated bending, they are UL and CSA Listed. For guaranteed print performance and durability, use with Tyco's 3300 series ribbon.

Features and benefits

- Manufactured with a white coated area for printing or writing on, and with a clear wrap to wind around a wire or cable over the printed surface to seal out impurities that would cause the label to become illegible.
- Protects printed information from chemicals and frequent handling.
- Designed to withstand exposure to oil, solvents, and water.
- Can also be flagged around a wire rather than wrapped.

**Temperature rating**

| | | |
|-----------------------------|----------------|-----------------|
| Operating temperature range | -54°C to +82°C | -65°F to +180°F |
|-----------------------------|----------------|-----------------|

Printer information

| | |
|--------------|----------------------------------|
| Tyco printer | T308S* (thermal transfer) |
| Tyco ribbon | 1330-3300-10* (thermal transfer) |

** Alternative printers and ribbons are available for special applications. Contact Tyco Electronics Identification for more information.*

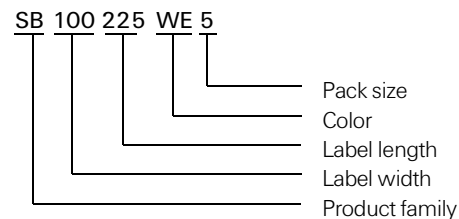
Part numbering system

SB Thermal transfer printable self-laminating labels (Cont'd)

Ordering information

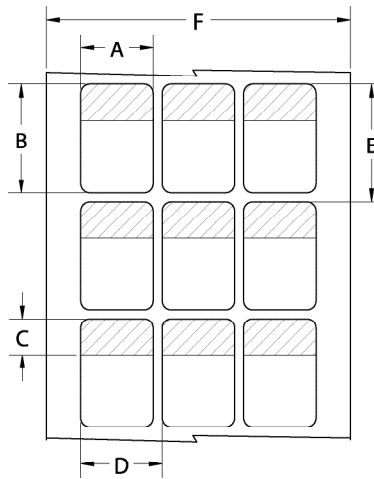

Available sizes and formats

| Ordering description | Package quantity | Labels across | (A) Label width | | (B) Label height | | (C) Printable height | | (D) Horizontal repeat | | (E) Vertical repeat | | (F) Web width | |
|----------------------|------------------|---------------|-----------------|---------------|------------------|---------------|----------------------|---------------|-----------------------|---------------|---------------------|---------------|---------------|---------------|
| | | | mm | <i>inches</i> | mm | <i>inches</i> | mm | <i>inches</i> | mm | <i>inches</i> | mm | <i>inches</i> | mm | <i>inches</i> |
| SB050100WE10 | 10,000 | 5 | 12.70 | <i>0.500</i> | 25.40 | <i>1.000</i> | 8.50 | <i>0.330</i> | 16.80 | <i>0.600</i> | 31.00 | <i>1.222</i> | 86.00 | <i>3.384</i> |
| SB050143WE10 | 10,000 | 5 | 12.70 | <i>0.500</i> | 36.50 | <i>1.437</i> | 12.70 | <i>0.500</i> | 16.80 | <i>0.662</i> | 42.20 | <i>1.661</i> | 86.00 | <i>3.384</i> |
| SB075094WE10 | 10,000 | 4 | 19.10 | <i>0.750</i> | 36.50 | <i>0.940</i> | 9.50 | <i>0.375</i> | 20.30 | <i>0.800</i> | 28.60 | <i>1.125</i> | 85.10 | <i>3.350</i> |
| SB080150WE10 | 10,000 | 4 | 20.30 | <i>0.800</i> | 38.10 | <i>1.500</i> | 12.70 | <i>0.500</i> | 22.90 | <i>0.900</i> | 44.50 | <i>1.750</i> | 94.90 | <i>3.736</i> |
| SB100143WE5 | 5,000 | 3 | 25.40 | <i>1.000</i> | 36.50 | <i>1.437</i> | 12.70 | <i>0.500</i> | 27.90 | <i>1.100</i> | 42.20 | <i>1.661</i> | 87.30 | <i>3.436</i> |
| SB100225WE5 | 5,000 | 3 | 25.40 | <i>1.000</i> | 57.20 | <i>2.250</i> | 19.10 | <i>0.750</i> | 27.90 | <i>1.100</i> | 66.70 | <i>2.625</i> | 87.30 | <i>3.436</i> |
| SB100375WE2.5 | 2,500 | 3 | 25.40 | <i>1.000</i> | 95.30 | <i>3.750</i> | 25.40 | <i>1.000</i> | 27.90 | <i>1.100</i> | 101.60 | <i>4.000</i> | 87.30 | <i>3.436</i> |
| SBH100375WE2.5 | 2,500 | 1* | 25.40 | <i>1.000</i> | 95.30 | <i>3.750</i> | 25.40 | <i>1.000</i> | N/A | N/A | 28.60 | <i>1.125</i> | 100.30 | <i>3.950</i> |
| SB100594WE1 | 1,000 | 3 | 25.40 | <i>1.000</i> | 151.00 | <i>5.940</i> | 38.10 | <i>1.500</i> | 27.90 | <i>1.100</i> | 158.80 | <i>6.250</i> | 87.30 | <i>3.436</i> |
| SB100743WE1 | 1,000 | 3 | 25.40 | <i>1.000</i> | 188.90 | <i>7.437</i> | 38.10 | <i>1.500</i> | 27.90 | <i>1.100</i> | 195.30 | <i>7.688</i> | 87.30 | <i>3.436</i> |
| SB190319WE2.5 | 2,500 | 2 | 48.30 | <i>1.900</i> | 81.00 | <i>3.190</i> | 19.10 | <i>0.750</i> | 50.80 | <i>2.000</i> | 87.40 | <i>3.440</i> | 105.10 | <i>4.138</i> |
| SB190594WE1 | 1,000 | 2 | 48.30 | <i>1.900</i> | 151.00 | <i>5.940</i> | 38.10 | <i>1.500</i> | 50.80 | <i>2.000</i> | 158.80 | <i>6.250</i> | 105.10 | <i>4.138</i> |
| SB200143WE2.5 | 2,500 | 2 | 50.80 | <i>2.000</i> | 36.50 | <i>1.437</i> | 12.70 | <i>0.500</i> | 50.80 | <i>2.000</i> | 42.20 | <i>1.661</i> | 107.60 | <i>4.236</i> |
| SB200225WE2.5 | 2,500 | 2 | 50.80 | <i>2.000</i> | 57.20 | <i>2.250</i> | 19.10 | <i>0.750</i> | 50.80 | <i>2.000</i> | 66.70 | <i>2.625</i> | 107.60 | <i>4.236</i> |
| SB200375WE2.5 | 2,500 | 2 | 50.80 | <i>2.000</i> | 95.30 | <i>3.750</i> | 25.40 | <i>1.000</i> | 53.30 | <i>2.100</i> | 101.60 | <i>4.000</i> | 111.40 | <i>4.386</i> |
| SB200743WE1 | 1,000 | 2 | 50.80 | <i>2.000</i> | 188.90 | <i>7.437</i> | 38.10 | <i>1.500</i> | 53.30 | <i>2.100</i> | 195.30 | <i>7.688</i> | 110.10 | <i>4.336</i> |

*One label across rotated format.

Options

| | | |
|--------|----------|-----------------------|
| Colors | Standard | White with clear tail |
|--------|----------|-----------------------|

tyco**Electronics**

Self-Laminating Labels

PVF Polyvinylfluoride thermal transfer printable self-laminating labels

Tyco PVF is a thermal transfer printable, translucent polyvinyl fluoride (Tedlar®) film with a permanent acrylic adhesive, designed for wire and cable marking applications that require the 'self-extinguishing' properties of Tedlar®. PVF labels are supplied with a white printable area, which is over-laminated upon application with the translucent portion of the label. This 'self-laminating' feature protects the printed area from exposure to oil, solvents, water and abrasion. The low-profile design makes PVF suitable for wrapping onto thin wire gauges. For guaranteed print performance and durability use with Tyco's 3300 series ribbon.

Features and benefits

- Resists water, oils, and conventional cleaning agents.
- Filters UV light.
- Exhibits high degree of resistance to aging.
- Thermal transfer printable.

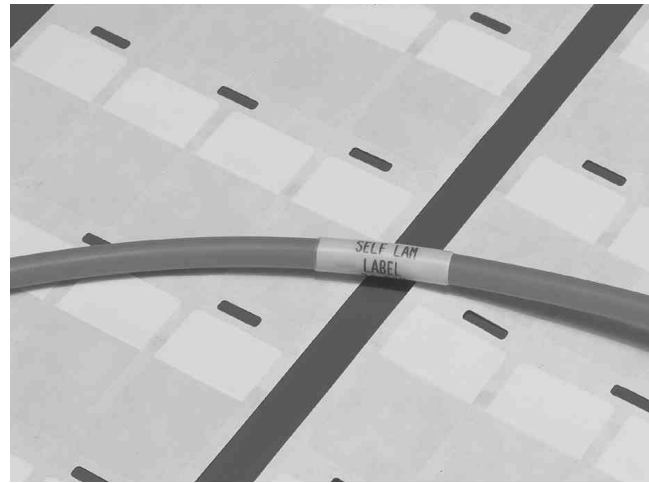
**Temperature rating**

Operating temperature range -40°C to +105°C -40°F to +221°F

Printer information

Tyco printer T308S* (thermal transfer)
Tyco ribbon 1330-3300-10* (thermal transfer)

**Alternative printers and ribbons are available for special applications. Contact Tyco Electronics Identification for more information.*

Part numbering system

PVF 080 150 WE 10

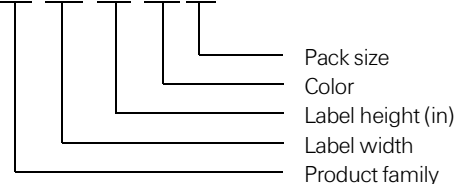

Ordering information



Available sizes and formats

| Ordering description | Package quantity | Labels across | (A) Label width | | (B) Label height | | (C) Printable height | | (D) Horizontal repeat | | (E) Vertical repeat | | (F) Web width | |
|----------------------|------------------|---------------|-----------------|---------------|------------------|---------------|----------------------|---------------|-----------------------|---------------|---------------------|---------------|---------------|---------------|
| | | | mm | <i>inches</i> | mm | <i>inches</i> | mm | <i>inches</i> | mm | <i>inches</i> | mm | <i>inches</i> | mm | <i>inches</i> |
| PVF050100WE10 | 10,000 | 5 | 12.70 | <i>0.500</i> | 25.40 | <i>1.000</i> | 8.50 | <i>0.330</i> | 16.80 | <i>0.600</i> | 31.00 | <i>1.222</i> | 86.00 | <i>3.384</i> |
| PVF050143WE10 | 10,000 | 5 | 12.70 | <i>0.500</i> | 36.50 | <i>1.437</i> | 12.70 | <i>0.500</i> | 16.80 | <i>0.662</i> | 42.20 | <i>1.661</i> | 86.00 | <i>3.384</i> |
| PVF080150WE10 | 10,000 | 4 | 20.30 | <i>0.800</i> | 38.10 | <i>1.500</i> | 12.70 | <i>0.500</i> | 22.90 | <i>0.900</i> | 44.50 | <i>1.750</i> | 94.90 | <i>3.736</i> |
| PVF100143WE5 | 5,000 | 3 | 25.40 | <i>1.000</i> | 36.50 | <i>1.437</i> | 12.70 | <i>0.500</i> | 27.90 | <i>1.100</i> | 42.20 | <i>1.661</i> | 87.30 | <i>3.436</i> |
| PVF100225WE5 | 5,000 | 3 | 25.40 | <i>1.000</i> | 57.20 | <i>2.250</i> | 19.10 | <i>0.750</i> | 27.90 | <i>1.100</i> | 66.70 | <i>2.625</i> | 87.30 | <i>3.436</i> |
| PVF100375WE2.5 | 2,500 | 3 | 25.40 | <i>1.000</i> | 95.30 | <i>3.750</i> | 25.40 | <i>1.000</i> | 27.90 | <i>1.100</i> | 101.60 | <i>4.000</i> | 87.30 | <i>3.436</i> |
| PVF100594WE1 | 1,000 | 3 | 25.40 | <i>1.000</i> | 151.0 | <i>5.940</i> | 38.10 | <i>1.500</i> | 27.90 | <i>1.100</i> | 158.80 | <i>6.250</i> | 87.30 | <i>3.436</i> |
| PVF100743WE1 | 1,000 | 3 | 25.40 | <i>1.000</i> | 188.9 | <i>7.437</i> | 38.10 | <i>1.500</i> | 27.90 | <i>1.100</i> | 195.30 | <i>7.688</i> | 87.30 | <i>3.436</i> |
| PVF190319WE2.5 | 2,500 | 2 | 48.30 | <i>1.900</i> | 81.00 | <i>3.190</i> | 19.10 | <i>0.750</i> | 50.80 | <i>2.000</i> | 87.40 | <i>3.440</i> | 105.10 | <i>4.138</i> |
| PVF190594WE1 | 1,000 | 2 | 48.30 | <i>1.900</i> | 151.00 | <i>5.940</i> | 38.10 | <i>1.500</i> | 50.80 | <i>2.000</i> | 158.80 | <i>6.250</i> | 105.10 | <i>4.138</i> |
| PVF200143WE2.5 | 2,500 | 2 | 50.80 | <i>2.000</i> | 36.50 | <i>1.437</i> | 12.70 | <i>0.500</i> | 50.80 | <i>2.000</i> | 42.20 | <i>1.661</i> | 107.60 | <i>4.236</i> |
| PVF200225WE2.5 | 2,500 | 2 | 50.80 | <i>2.000</i> | 57.20 | <i>2.250</i> | 19.10 | <i>0.750</i> | 50.80 | <i>2.000</i> | 66.70 | <i>2.625</i> | 107.60 | <i>4.236</i> |
| PVF200375WE2.5 | 2,500 | 2 | 50.80 | <i>2.000</i> | 95.30 | <i>3.750</i> | 25.40 | <i>1.000</i> | 53.30 | <i>2.100</i> | 101.60 | <i>4.000</i> | 111.40 | <i>4.386</i> |
| PVF200743WE1 | 1,000 | 2 | 50.80 | <i>2.000</i> | 188.90 | <i>7.437</i> | 38.10 | <i>1.500</i> | 53.30 | <i>2.100</i> | 195.30 | <i>7.688</i> | 110.10 | <i>4.336</i> |

Options

Colors Standard White with clear tail

TW Dot matrix printable self-laminating labels

Tyco TW is a dot matrix printable, translucent vinyl film with a permanent acrylic adhesive, supplied with a white printable area, which is over-laminated upon application with the translucent portion of the label. This 'self-laminating' feature protects the printed area from exposure to oil, solvents, water and abrasion. TW labels offer excellent conformability to round, irregular or flexible surfaces, and are ideal for wire and cable identification, including flat ribbon cables that are subject to repeated bending. They are UL and CSA Listed, with guaranteed print performance and durability, when used with Tyco's RI Quick Dry series ribbon.

Features and benefits

- Manufactured with a white coated area for printing or writing on, and with a clear wrap to wind around a wire or cable over the printed surface to seal out impurities that would cause the label to become illegible.
- Protects printed information from chemicals and frequent handling.
- Designed to withstand exposure to oil, solvents, and water.
- Can also be flagged around a wire rather than wrapped.



Temperature rating

Operating temperature range -40°C to $+80^{\circ}\text{C}$ -40°F to $+176^{\circ}\text{F}$

Printer information

Tyco printer L0870* (dot matrix)
Tyco ribbon 1330-0037-00* (dot matrix)

* Alternative printers and ribbons are available for special applications. Contact Tyco Electronics Identification for more information.

Part numbering system

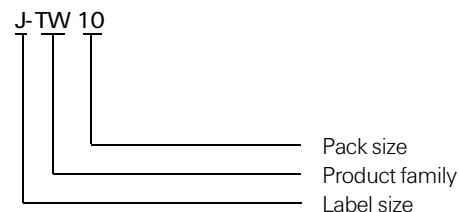

Ordering information



Available sizes and formats

| Ordering description | Package quantity | Labels across | (A) Label width | | (B) Label height | | (C) Printable height | | (D) Horizontal repeat | | (E) Vertical repeat | | (F) Web width | |
|----------------------|------------------|---------------|-----------------|---------------|------------------|---------------|----------------------|---------------|-----------------------|---------------|---------------------|---------------|---------------|---------------|
| | | | mm | <i>inches</i> | mm | <i>inches</i> | mm | <i>inches</i> | mm | <i>inches</i> | mm | <i>inches</i> | mm | <i>inches</i> |
| J-TW10 | 10,000 | 12 | 12.70 | <i>0.500</i> | 19.10 | <i>0.750</i> | 9.50 | <i>0.375</i> | 15.20 | <i>0.600</i> | 25.40 | <i>1.000</i> | 205.70 | <i>8.100</i> |
| N-TW10 | 10,000 | 16 | 12.70 | <i>0.500</i> | 36.50 | <i>1.437</i> | 12.70 | <i>0.500</i> | 12.70 | <i>0.500</i> | 38.10 | <i>1.500</i> | 228.60 | <i>9.000</i> |
| Q-TW10 | 10,000 | 9 | 19.10 | <i>0.750</i> | 44.50 | <i>1.750</i> | 12.70 | <i>0.500</i> | 22.90 | <i>0.900</i> | 50.80 | <i>2.000</i> | 227.30 | <i>8.950</i> |
| A-TW10 | 10,000 | 6 | 20.30 | <i>0.800</i> | 36.50 | <i>1.437</i> | 12.70 | <i>0.500</i> | 22.90 | <i>0.900</i> | 38.10 | <i>1.500</i> | 160.00 | <i>6.300</i> |
| O-TW10 | 10,000 | 8 | 25.40 | <i>1.000</i> | 36.50 | <i>1.437</i> | 12.70 | <i>0.500</i> | 25.40 | <i>1.000</i> | 38.10 | <i>1.500</i> | 228.60 | <i>9.000</i> |
| R-TW5 | 5,000 | 8 | 25.40 | <i>1.000</i> | 57.20 | <i>2.250</i> | 19.10 | <i>0.750</i> | 25.40 | <i>1.000</i> | 63.50 | <i>2.500</i> | 228.60 | <i>9.000</i> |
| T-TW2.5 | 2,500 | 8 | 25.40 | <i>1.000</i> | 95.30 | <i>3.750</i> | 25.40 | <i>1.000</i> | 25.40 | <i>1.000</i> | 101.60 | <i>4.000</i> | 228.60 | <i>9.000</i> |
| W1-TW1 | 1,000 | 8 | 25.40 | <i>1.000</i> | 150.90 | <i>5.940</i> | 38.10 | <i>1.500</i> | 25.40 | <i>1.000</i> | 152.40 | <i>6.000</i> | 228.60 | <i>9.000</i> |
| D1-TW1 | 1,000 | 7 | 25.40 | <i>1.000</i> | 188.90 | <i>7.437</i> | 38.10 | <i>1.500</i> | 27.90 | <i>1.100</i> | 190.50 | <i>7.500</i> | 218.40 | <i>8.600</i> |
| C1-TW2.5 | 2,500 | 3 | 48.30 | <i>1.900</i> | 81.00 | <i>3.190</i> | 19.10 | <i>0.750</i> | 50.80 | <i>2.000</i> | 88.90 | <i>3.500</i> | 175.30 | <i>6.900</i> |
| P-TW5 | 5,000 | 4 | 50.80 | <i>2.000</i> | 36.50 | <i>1.437</i> | 12.70 | <i>0.500</i> | 50.80 | <i>2.000</i> | 38.10 | <i>1.500</i> | 228.60 | <i>9.000</i> |
| S-TW2.5 | 2,500 | 4 | 50.80 | <i>2.000</i> | 57.20 | <i>2.250</i> | 19.10 | <i>0.750</i> | 50.80 | <i>2.000</i> | 63.50 | <i>2.500</i> | 228.60 | <i>9.000</i> |
| U-TW2.5 | 2,500 | 4 | 50.80 | <i>2.000</i> | 95.30 | <i>3.750</i> | 25.40 | <i>1.000</i> | 50.80 | <i>2.000</i> | 101.60 | <i>4.000</i> | 228.60 | <i>9.000</i> |
| W2-TW1 | 1,000 | 3 | 50.80 | <i>2.000</i> | 150.90 | <i>5.940</i> | 38.10 | <i>1.500</i> | 53.30 | <i>2.100</i> | 152.40 | <i>6.000</i> | 182.90 | <i>7.200</i> |
| D3-TW1 | 1,000 | 3 | 50.80 | <i>2.000</i> | 188.90 | <i>7.437</i> | 38.10 | <i>1.500</i> | 55.90 | <i>2.200</i> | 190.50 | <i>7.500</i> | 188.00 | <i>7.400</i> |

Options

| | | |
|--------|----------|-----------------------|
| Colors | Standard | White with clear tail |
|--------|----------|-----------------------|

tyco**Electronics**

Self-Laminating Labels

PV Polyvinylfluoride dot matrix printable self-laminating labels

Tyco PV is a dot matrix printable, translucent polyvinyl fluoride (Tedlar®) film with a permanent acrylic adhesive, designed for wire and cable marking applications that require the 'self-extinguishing' properties of Tedlar®. PV labels are supplied with a white printable area, which is over-laminated upon application with the translucent portion of the label. This 'self-laminating' feature protects the printed area from exposure to oil, solvents, water and abrasion. The low-profile design makes PV suitable for wrapping onto thin wire gauges. For guaranteed print performance and durability, use with Tyco's RI Quick Dry series ribbon.

Features and benefits

- Resists water, oils, and conventional cleaning agents.
- Filters UV light.
- Exhibits high degree of resistance to ageing.
- Thermal transfer printable.

**Temperature rating**

Operating temperature range -40°C to +105°C -40°F to +221°F

Printer information

Tyco printer LQ870* (dot matrix)
 Tyco ribbon 1330-0037-00* (dot matrix)

**Alternative printers and ribbons are available for special applications. Contact Tyco Electronics Identification for more information.*

Part numbering system

N-PV 10

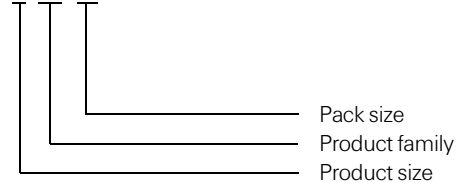

Ordering information



Available sizes and formats

| Ordering description | Package quantity | Labels across | (A) Label width | | (B) Label height | | (C) Printable height | | (D) Horizontal repeat | | (E) Vertical repeat | | (F) Web width | |
|----------------------|------------------|---------------|-----------------|---------------|------------------|---------------|----------------------|---------------|-----------------------|---------------|---------------------|---------------|---------------|---------------|
| | | | mm | <i>inches</i> | mm | <i>inches</i> | mm | <i>inches</i> | mm | <i>inches</i> | mm | <i>inches</i> | mm | <i>inches</i> |
| J-PV10 | 10,000 | 12 | 12.70 | <i>0.500</i> | 19.10 | <i>0.750</i> | 9.50 | <i>0.375</i> | 15.20 | <i>0.600</i> | 25.40 | <i>1.000</i> | 205.70 | <i>8.100</i> |
| N-PV10 | 10,000 | 16 | 12.70 | <i>0.500</i> | 36.50 | <i>1.437</i> | 12.70 | <i>0.500</i> | 12.70 | <i>0.500</i> | 38.10 | <i>1.500</i> | 228.60 | <i>9.000</i> |
| Q-PV10 | 10,000 | 9 | 19.10 | <i>0.750</i> | 44.50 | <i>1.750</i> | 12.70 | <i>0.500</i> | 22.90 | <i>0.900</i> | 50.80 | <i>2.000</i> | 227.30 | <i>8.950</i> |
| A-PV10 | 10,000 | 6 | 20.30 | <i>0.800</i> | 36.50 | <i>1.437</i> | 12.70 | <i>0.500</i> | 22.90 | <i>0.900</i> | 38.10 | <i>1.500</i> | 160.00 | <i>6.300</i> |
| O-PV10 | 10,000 | 8 | 25.40 | <i>1.000</i> | 36.50 | <i>1.437</i> | 12.70 | <i>0.500</i> | 25.40 | <i>1.000</i> | 38.10 | <i>1.500</i> | 228.60 | <i>9.000</i> |
| R-PV5 | 5,000 | 8 | 25.40 | <i>1.000</i> | 57.20 | <i>2.250</i> | 19.10 | <i>0.750</i> | 25.40 | <i>1.000</i> | 63.50 | <i>2.500</i> | 228.60 | <i>9.000</i> |
| T-PV2.5 | 2,500 | 8 | 25.40 | <i>1.000</i> | 95.30 | <i>3.750</i> | 25.40 | <i>1.000</i> | 25.40 | <i>1.000</i> | 101.60 | <i>4.000</i> | 228.60 | <i>9.000</i> |
| W1-PV1 | 1,000 | 8 | 25.40 | <i>1.000</i> | 150.90 | <i>5.940</i> | 38.10 | <i>1.500</i> | 25.40 | <i>1.000</i> | 152.40 | <i>6.000</i> | 228.60 | <i>9.000</i> |
| D1-PV1 | 1,000 | 7 | 25.40 | <i>1.000</i> | 188.90 | <i>7.437</i> | 38.10 | <i>1.500</i> | 27.90 | <i>1.100</i> | 190.50 | <i>7.500</i> | 218.40 | <i>8.600</i> |
| C1-PV2.5 | 2,500 | 3 | 48.30 | <i>1.900</i> | 81.00 | <i>3.190</i> | 19.10 | <i>0.750</i> | 50.80 | <i>2.000</i> | 88.90 | <i>3.500</i> | 175.30 | <i>6.900</i> |
| P-PV5 | 5,000 | 4 | 50.80 | <i>2.000</i> | 36.50 | <i>1.437</i> | 12.70 | <i>0.500</i> | 50.80 | <i>2.000</i> | 38.10 | <i>1.500</i> | 228.60 | <i>9.000</i> |
| S-PV2.5 | 2,500 | 4 | 50.80 | <i>2.000</i> | 57.20 | <i>2.250</i> | 19.10 | <i>0.750</i> | 50.80 | <i>2.000</i> | 63.50 | <i>2.500</i> | 228.60 | <i>9.000</i> |
| U-PV2.5 | 2,500 | 4 | 50.80 | <i>2.000</i> | 95.30 | <i>3.750</i> | 25.40 | <i>1.000</i> | 50.80 | <i>2.000</i> | 101.60 | <i>4.000</i> | 228.60 | <i>9.000</i> |
| W2-PV1 | 1,000 | 3 | 50.80 | <i>2.000</i> | 150.90 | <i>5.940</i> | 38.10 | <i>1.500</i> | 53.30 | <i>2.100</i> | 152.40 | <i>6.000</i> | 182.90 | <i>7.200</i> |
| D3-PV1 | 1,000 | 3 | 50.80 | <i>2.000</i> | 188.90 | <i>7.437</i> | 38.10 | <i>1.500</i> | 55.90 | <i>2.200</i> | 190.50 | <i>7.500</i> | 188.00 | <i>7.400</i> |

Options

| | | |
|--------|----------|-----------------------|
| Colors | Standard | White with clear tail |
|--------|----------|-----------------------|

tyco**Electronics**

Self-Laminating Labels

LSR Laser printable self-laminating labels

Tyco LSR is a laser printable, translucent polyester film with a permanent acrylic adhesive, supplied with a white printable area, which is over-laminated upon application with the translucent portion of the label. This 'self-laminating' feature protects the printed area from exposure to oil, solvents, water and abrasion with good conformability to round surfaces. LSR is ideal for wire and cable marking including flat ribbon cable. The low-profile design makes LSR suitable for wrapping onto thin wire gauges.

Features and benefits

- Manufactured with a white coated area for printing or writing on, and with a clear wrap to wind around a wire or cable over the printed surface to seal out impurities that would cause the label to become illegible.
- Protects printed information from chemicals and frequent handling.
- Designed to withstand exposure to oil, solvents, and water.
- Can also be flagged around a wire rather than wrapped.

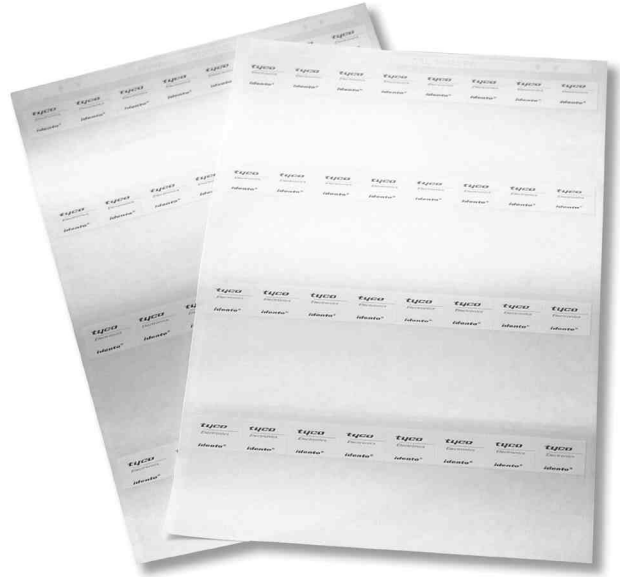
**Temperature rating**

Operating temperature range -40°C to $+150^{\circ}\text{C}$ -40°F to $+302^{\circ}\text{F}$

Printer information

Standard laser printer with auto/manual sheet feed.
Contact Tyco Electronics Identification for more information.

LSR Laser printable self-laminating labels (Cont'd)

Ordering information



Available sizes and formats

| Ordering description | Package quantity | Labels across | Labels per sheet | (A) Label width | | (B) Label height | | (C) Printable height | | (D) Horizontal repeat | | (E) Vertical repeat | |
|----------------------|------------------|---------------|------------------|-----------------|---------------|------------------|---------------|----------------------|---------------|-----------------------|---------------|---------------------|---------------|
| | | | | mm | <i>inches</i> | mm | <i>inches</i> | mm | <i>inches</i> | mm | <i>inches</i> | mm | <i>inches</i> |
| CR-100-LSR | 4,992 | 13 | 156 | 12.70 | <i>0.500</i> | 19.10 | <i>0.750</i> | 9.40 | <i>0.370</i> | 15.20 | <i>0.600</i> | 20.60 | <i>0.810</i> |
| CR-101-LSR | 4,992 | 13 | 78 | 12.70 | <i>0.500</i> | 38.10 | <i>1.500</i> | 12.70 | <i>0.500</i> | 15.20 | <i>0.600</i> | 40.60 | <i>1.600</i> |
| CR-105-LSR | 5,040 | 7 | 84 | 25.40 | <i>1.000</i> | 19.10 | <i>0.750</i> | 8.60 | <i>0.340</i> | 27.90 | <i>1.100</i> | 20.60 | <i>0.810</i> |
| CR-106-LSR | 2,520 | 7 | 63 | 25.40 | <i>1.000</i> | 25.40 | <i>1.000</i> | 8.60 | <i>0.340</i> | 27.90 | <i>1.100</i> | 27.90 | <i>1.100</i> |
| CR-107-LSR | 2,499 | 7 | 49 | 25.40 | <i>1.000</i> | 33.80 | <i>1.330</i> | 12.70 | <i>0.500</i> | 27.90 | <i>1.100</i> | 36.60 | <i>1.440</i> |
| CR-108-LSR | 1,008 | 7 | 21 | 25.40 | <i>1.000</i> | 80.50 | <i>3.170</i> | 24.60 | <i>0.970</i> | 27.90 | <i>1.100</i> | 84.10 | <i>3.310</i> |
| CR-110-LSR | 1,008 | 4 | 12 | 47.80 | <i>1.880</i> | 80.50 | <i>3.170</i> | 24.60 | <i>0.970</i> | 50.80 | <i>2.000</i> | 83.30 | <i>3.280</i> |

Self-Laminating Label Dimensions



Self-Laminating Label Dimensions (Cont'd)



K-Type™ cable markers

K-Type™ markers are used to identify wire bundles, cables, pipes and conduits using specially designed oval shaped, individual characters that slide on to a PVC carrier, which is then attached to the substrate using cable ties. K-Type™ markers are ideal for post termination applications or where retrofit is anticipated.

These markers are supplied yellow with black legends and in the standard International colour code option and are supplied on reels. K-Type™ markers come in one standard size to fit carrier strips that can hold from 7 to 18 markers and are made from a plasticized PVC material.



Features and benefits

- Versatile marking system for cables , cable bundels and conduit.
- Elliptical marker profile allows easy fitting to carrier strips.



Temperature rating

Operating temperature range -40°C to +70°C -40°F to +158°F

Part numbering system



K-Type™ cable markers (Cont'd)

Ordering information

MARKERS

| Order code | Marker size | Cable diameter (mm) | Reel quantity |
|------------|-------------|---------------------|---------------|
| 1361 | 65 | 4.2 – 7.0 | 500 |

CARRIER STRIPS

| Order code | Capacity | Quantity |
|------------|------------|----------|
| 11320000 | 7 markers | 500 |
| 11310000 | 12 markers | 500 |
| 11300000 | 18 markers | 250 |
| 11330000 * | 12 markers | 100 |

* This carrier can be used to flag

International color code

| Legend | Color | Legend | Color | Legend | Color | Legend | Color |
|--------|--------|--------|-------|--------|-------|--------|--------|
| 0 | Black | 1 | Brown | 2 | Red | 3 | Orange |
| 4 | Yellow | 5 | Green | 6 | Blue | 7 | Violet |
| 8 | Gray | 9 | White | | | | |

Legend code

| Legend | Code | Legend | Code | Legend | Code |
|--------|------|--------|------|--------|------|
| 0 | 00 | J | 19 | / | 38 |
| 1 | 01 | K | 20 | ~ | 39 |
| 2 | 02 | L | 21 | Earth | 40 |
| 3 | 03 | M | 22 |) | 41 |
| 4 | 04 | N | 23 | Blank | 42 |
| 5 | 05 | O | 24 | : | 43 |
| 6 | 06 | P | 25 | , | 44 |
| 7 | 07 | Q | 26 | < | 45 |
| 8 | 08 | R | 27 | > | 46 |
| 9 | 09 | S | 28 | + | 47 |
| A | 10 | T | 29 | . | 48 |
| B | 11 | U | 30 | | |
| C | 12 | V | 31 | | |
| D | 13 | W | 32 | | |
| E | 14 | X | 33 | | |
| F | 15 | Y | 34 | | |
| G | 16 | Z | 35 | | |
| H | 17 | + | 36 | | |
| I | 18 | - | 37 | | |

tyco**Electronics**

Pre-Printed Wire & Cable Markers

Z-type™ push-on wire markers

Z-Type™ markers are individual push-on characters used to identify wires and small cables permanently. They are designed with an expanding profile, enabling each marker to accommodate a wide range of wire/cable sizes. Z-Type™ markers are a simple, cost-effective solution for many commercial wire identification applications. The markers are supplied either straight cut or chevron cut: the chevron cut option ensures the legends remain aligned. Standard Z-Type™ markers are yellow or white with black legends and can be supplied as loose pieces packed in boxes or on reels. Color coded markers are also available.

Features and benefits

- Resistant to sea water, fuels and oils.
- 9 sizes covering wire diameters from 1.5mm to 12.7mm (0.06 inches to 0.5 inches)
- Applicator wands available for easy marker installation.

**Temperature rating**

Operating temperature range -45°C to +70°C -50°F to +158°F

Part numbering system

0616 1 4 00

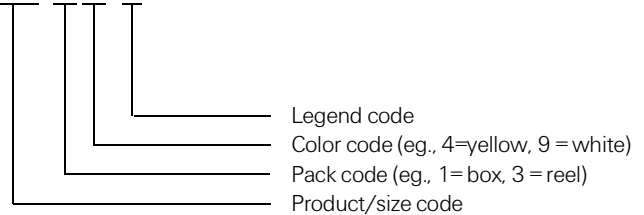

Z-type™ push-on wire markers (Cont'd)

Ordering information

| Order code (straight cut) | Order code (chevron cut) | Marker size | Pack quantity | Cable diameter |
|---------------------------|--------------------------|-------------|---------------|--------------------------|
| 0580 | 1151 | 5 | 1000 | 1.5 - 2.0 (0.06 - 0.08) |
| 0581 | 1152 | 7 | 1000 | 2.0 - 3.2 (0.08 - 0.13) |
| 0615 | 1153 | 9 | 1000 | 2.5 - 4.0 (0.10 - 0.16) |
| 0616 | 1154 | 11 | 1000 | 2.9 - 4.7 (0.11 - 0.19) |
| 0617 | 1155 | 13 | 1000 | 3.4 - 5.7 (0.13 - 0.22) |
| 0618 | 1156 | 15 | 1000 | 3.8 - 6.3 (0.15 - 0.25) |
| 0620 | 1157 | 18 | 500 | 4.3 - 6.9 (0.17 - 0.27) |
| 0622 | 1158 | 23 | 500 | 5.5 - 8.9 (0.22 - 0.35) |
| 0624 | 1159 | 35 | 250 | 7.9 - 12.7 (0.31 - 0.50) |

Color code: Color coded markers conform to the international standard system (0 on a black marker, 1 on a brown marker, etc.) To order color coded markers replace the last three characters of the order code as follows:

| Legend | Marker Colour | Order Code | Legend | Marker Colour | Order Code |
|--------|---------------|------------|--------|---------------|------------|
| 0 | Black | 000 | 1 | Brown | 101 |
| 2 | Red | 202 | 3 | Orange | 303 |
| 4 | Yellow | 404 | 5 | Green | 505 |
| 6 | Blue | 606 | 7 | Violet | 707 |
| 8 | Gray | 808 | 9 | White | 909 |

Order example:

06161400 (Z-Type™ markers, size 11, yellow marker with black legend 0, boxed)

Applicators

| Order Code | Marker Size | Pack Quantity | Order Code | Marker Size | Pack Quantity |
|------------|-------------|---------------|------------|-------------|---------------|
| 12510000 | 7 | 1 | 12520000 | 9 | 1 |
| 12530000 | 11 | 1 | 12540000 | 13 | 1 |
| 12550000 | 15 | 1 | 12560000 | 18 | 1 |

Legend code

| Legend | Code | Legend | Code | Legend | Code |
|--------|------|--------|------|--------|------|
| 0 | 00 | J | 19 | / | 38 |
| 1 | 01 | K | 20 | ~ | 39 |
| 2 | 02 | L | 21 | Earth | 40 |
| 3 | 03 | M | 22 |) | 41 |
| 4 | 04 | N | 23 | Blank | 42 |
| 5 | 05 | O | 24 | : | 43 |
| 6 | 06 | P | 25 | , | 44 |
| 7 | 07 | Q | 26 | < | 45 |
| 8 | 08 | R | 27 | > | 46 |
| 9 | 09 | S | 28 | + | 47 |
| A | 10 | T | 29 | . | 48 |
| B | 11 | U | 30 | | |
| C | 12 | V | 31 | | |
| D | 13 | W | 32 | | |
| E | 14 | X | 33 | | |
| F | 15 | Y | 34 | | |
| G | 16 | Z | 35 | | |
| H | 17 | + | 36 | | |
| I | 18 | - | 37 | | |

Packaging Options available

| Straight Cut | | Chevron cut | |
|----------------------------------|--------------|----------------------------------|--------------|
| White marker with black legend: | Boxes, reels | White marker with black legend: | Boxes |
| Yellow marker with black legend: | Reels | Yellow marker with black legend: | Reels |
| Color coded | Boxes | Color coded | Boxes, reels |

Snap-On Markers

Tyco snap-on markers are convenient and easy to use. These markers are supplied on a 'wand' applicator that simplifies and reduces installation time, and saves on the cost of marking.

Snap-on markers are designed to stand the test of time, preventing costly re-work before the life of the equipment ends. This is why Tyco snap-on markers are found today in power stations, oil refineries, offshore platforms, and other major projects around the world.

Features and benefits

- Snap-on markers are the perfect way to permanently and rapidly mark cables, wires, leads, and cores after termination and installation.
- Easy to alter identification on cables that are already marked.
- Secure grip for positive fixing to cable.
- The high elasticity of the marker enables all types of installation and conduction material to be permanently marked without damage.
- Applicator has a patented slit to prevent over-expansion of the marker during application.
- Made from polyoxymethylene which guarantees strength, dimensional stability, low moisture absorption, and resistance to chemicals.
- Resistant against oils, cleaning agents, fuels, and alkaline solutions.
- Zero-halogen material.
- Ten sizes for cable diameters 0.04" to 0.75" (1.0mm to 19.0mm).
- Color-coded option.



Temperature rating

Operating temperature range -40°C to +106°C -40°F to +223°F



Part numbering system



Snap-On Markers (Cont'd)

Ordering information

| For Cable Diameter Inches | mm | Color of Mounting Wand | Packed Box | Order |
|------------------------------|---------------|------------------------|--|--------|
| 0.040 - 0.055 | 1.00 - 1.40 | Brown | 10 mounting wands with 30 identical markers | STD 01 |
| 0.055 - 0.071 | 1.40 - 1.80 | Gray | 10 mounting wands with 30 identical markers | STD 02 |
| 0.075 - 0.104 | 1.90 - 2.65 | Green | 10 mounting wands with 30 identical markers | STD 03 |
| 0.102 - 0.138 | 2.60 - 3.50 | Red | 10 mounting wands with 30 identical markers | STD 06 |
| 0.128 - 0.177 | 3.25 - 4.50 | Blue | 10 mounting wands with 30 identical markers | STD 09 |
| 0.177 - 0.236 | 4.50 - 6.00 | Yellow | 10 mounting wands with 30 identical markers | STD 12 |
| 0.228 - 0.335 | 5.80 - 8.50 | Orange* | 50 identical markers; mounting wand available on request | STD 15 |
| 0.335 - 0.452 | 8.50 - 11.50 | Orange* | 50 identical markers; mounting wand available on request | STD 17 |
| 0.433 - 0.610 | 11.00 - 15.50 | Gray* | 50 identical markers; mounting wand available on request | STD 21 |
| 0.590 - 0.750 | 15.00 - 19.00 | Gray* | 50 identical markers; mounting wand available on request | STD 24 |

*Mounting wands for STD 15, STD 17, STD 21, and STD 24 - Order Codes: STD 15MO, STD 17MO, STD 21MO, and ST 24MO
 NOTE - All markers available 0-9,A-Z, (+), (-), (.), (/), (^), (v), (.), (.), and "blank"

tyco**Electronics**

Pre-Printed Wire & Cable Markers

CWM Wire marker cards

Tyco CWM are pre-printed wire markers made with our white vinyl coated cloth tape material, supplied on a thick, easy to handle card stock, with a permanent, rubber based, pressure sensitive adhesive for easy application. Ideal for basic wire marking applications where pre-printed single or double-digit legends and some resistance to a variety of solvents, water, oil, dirt and heat is required.

Features and benefits

- Convenient and easy to use.
- Pre-printed for on-site wire marking.
- Available in colors for color coding applications.
- Available in single and multiple digit legends.

**Temperature rating**

Operating temperature range -40°C to +82°C -40°F to +180°F

CWM Wire marker cards (Cont'd)

Ordering information

| Product Order Code | Legend Option | Package Quantity | Label Width | | Label Height | | Card Width | | Card Height | |
|--------------------|---------------------|-----------------------|-------------|--------|--------------|--------|------------|--------|-------------|--------|
| | | | mm | inches | mm | inches | mm | inches | mm | inches |
| CWM-SL-# * | Solid Letters 0-99 | 25 Cards (825 labels) | 6.4 | 0.250 | 38.1 | 1.500 | 235.0 | 9.250 | 50.8 | 2.000 |
| CWM-SL-letter * | Solid Letters A - Z | 25 Cards (825 labels) | 6.4 | 0.250 | 38.1 | 1.500 | 235.0 | 9.250 | 50.8 | 2.000 |
| CWM-SL-color * | Solid Colors | 25 Cards (825 labels) | 6.4 | 0.250 | 38.1 | 1.500 | 235.0 | 9.250 | 50.8 | 2.000 |
| CWM-SL-legend * | Solid 2+ Digits | 25 Cards (825 labels) | 6.4 | 0.250 | 38.1 | 1.500 | 235.0 | 9.250 | 50.8 | 2.000 |
| CWM-SQ-1-33 | Sequential 1 - 33 | 25 Cards (825 labels) | 6.4 | 0.250 | 38.1 | 1.500 | 235.0 | 9.250 | 50.8 | 2.000 |
| CWM-SQ-34-66 | Sequential 34 - 66 | 25 Cards (825 labels) | 6.4 | 0.250 | 38.1 | 1.500 | 235.0 | 9.250 | 50.8 | 2.000 |
| CWM-SQ-67-99 | Sequential 67 - 99 | 25 Cards (825 labels) | 6.4 | 0.250 | 38.1 | 1.500 | 235.0 | 9.250 | 50.8 | 2.000 |
| CWM-SQ-A-Z | Sequential A - Z | 25 Cards (825 labels) | 6.4 | 0.250 | 38.1 | 1.500 | 235.0 | 9.250 | 50.8 | 2.000 |
| CWM-SQ-AA-ZZ | Sequential AA - ZZ | 25 Cards (825 labels) | 6.4 | 0.250 | 38.1 | 1.500 | 235.0 | 9.250 | 50.8 | 2.000 |
| CWM-SQ-a-z | Sequential a - z | 25 Cards (825 labels) | 6.4 | 0.250 | 38.1 | 1.500 | 235.0 | 9.250 | 50.8 | 2.000 |
| CWM-SQ-1-6 | Sequential 1 - 6 | 25 Cards (825 labels) | 6.4 | 0.250 | 38.1 | 1.500 | 235.0 | 9.250 | 50.8 | 2.000 |
| CWM-SQ-1-18 | Sequential 1 - 18 | 25 Cards (825 labels) | 6.4 | 0.250 | 38.1 | 1.500 | 235.0 | 9.250 | 50.8 | 2.000 |

*Solid cards (SL) = 1 legend on each card. Select a single legend and add to the suffix of the product order code.
 Sequential cards (SQ) = a consecutive range of alpha or numeric legends on each card, as specified in the suffix of the product order code.
 Available options on product order code CWM-SL-legends are: T1, T2, T3, L1, L2, L3, GND, P1, A1, XS, PTO. Add legend suffix of order code.



Electronics

THERMAL TRANSFER LABELS

| | | | |
|-------------------------------------|----|-----------------------------------|----|
| WP White Polyester | 66 | T1K Standard Polyimide | 85 |
| CP Clear Polyester | 68 | T2K High-performance Polyimide .. | 86 |
| HW HighTack White Polyester | 70 | TAK Amber Polyimide | 87 |
| HM High Tack Metalized Polyester .. | 72 | TSK Static-safe Polyimide | 88 |
| MP Metalized Polyester | 74 | T2Y Modified Polyimide | 89 |
| MV Metalized Void Polyester | 76 | KTT Tan Polyimide | 90 |
| TN Destructible Polyethylene | 78 | PVF Polyvinyl Fluoride | 92 |
| WV White Vinyl | 80 | EP Paper | 94 |
| NC Nylon Cloth | 82 | | |



DOT MATRIX LABELS

| | |
|-----------------------------|-----|
| C Vinyl Cloth | 96 |
| M Metalized Polyester | 98 |
| K Polyimide (Kapton®) | 100 |
| E Polyester | 102 |

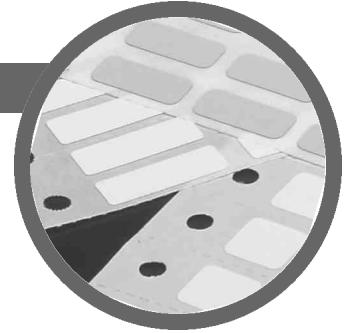

LASER LABELS

| | |
|------------------------------|-----|
| LE Polyester | 104 |
| LM Metalized Polyester | 104 |
| LEB2 Polyester | 104 |



Label format - Product order code / Cross reference

Thermal transfer

| Old label format | New product order code | Old label format | New product order code |
|------------------|------------------------|------------------|------------------------|
| 100 | TTP400XX-10 | 138 | XX-080080-10-# |
| 101 | XX-381064-10-# | 139 | XX-178095-10-# |
| 102 | XX-381191-5-# | 201 | XX-381064-10-# |
| 103 | XX-699254-5-# | 205 | XX-191064-10-# |
| 104 | XX-762508-2.5-# | 214 | XX-508127-10-# |
| 105 | XX-191064-10-# | 230 | XX-203127-10-# |
| 106 | XX-101165-0.85-# | 901 | XX-127032-10-# |
| 107 | XX-254127-10-# | 902 | XX-040033-10-# |
| 108 | XX-064064-25-# | 903 | XX-254045-10-# |
| 109 | XX-165051-25-# | 904 | XX-089047-10-# |
| 110 | XX-254097-10-# | 905 | XX-305047-10-# |
| 111 | XX-318064-10-# | 906 | XX-445064-10-# |
| 112 | XX-508064-10-# | 907 | XX-254064-10-# |
| 114 | XX508127-10-# | 908 | XX-095080-25-# |
| 115 | XX-254254-10-# | 909 | XX-208086-5-# |
| 116 | XX-095095-10-# | 911 | XX-508095-5-# |
| 117 | XX-508318-2.5-# | 912 | XX-318097-10-# |
| 118 | XX-762381-2.5-# | 913 | XX-165102-10-# |
| 119 | XX-101635-2.5-# | 914 | XX-445102-5-# |
| 121 | XX-523841-1.5-# | 916 | XX-127127-10-# |
| 122 | XX-127111-10-# | 917 | XX-381127-5-# |
| 123 | XX-508254-5-# | 918 | XX-222159-15-# |
| 124 | XX-508508-3-# | 919 | XX-171171-10-# |
| 125 | XX-101508-2.5-# | 920 | XX-478175-5-# |
| 126 | XX-101762-1.8-# | 921 | XX-699191-5-# |
| 127 | XX-101101-1.3-# | 922 | XX-406254-1.5-# |
| 128 | XX-762127-1-# | 923 | XX-250381-10-# |
| 129 | XX-229064-10-# | 924 | XX-381381-2.5-# |
| 130 | XX-203127-10-# | 925 | XX-610419-2.5-# |
| 132 | XX-381020-10-# | 926 | XX-445445-2-# |
| 134 | XX-165051-25-# | 927 | XX-381635-5-# |
| 136 | XX-040040-25-# | 928 | XX-191762-5-# |
| 137 | XX-114040-25-# | | |

XX = Insert material code from table below. # = Insert color code from table below right.

Examples

| Examples | Old part number | New part number |
|------------------|-----------------|-----------------|
| Thermal transfer | 101-T1K-10 | T1K-381064-10-9 |
| Dot matrix | 3-EW10F | E-191064-10-9 |

Dot matrix

| Old label format | New product order code |
|------------------|------------------------|
| 1 | X-165051-10-# |
| 3 | X-191064-10-# |
| 4 | X-203127-10-# |
| 5 | X-254095-10-# |
| 6A | X-508095-5-# |
| 7 | X-254127-10-# |
| 8 | X-381191-10-# |
| 11 | X-699254-2.5-# |
| 12 | X-920381-2.5-# |
| 13 | X-920254-2.5-# |
| 16 | X-203365-10-# |
| 17 | X-076191-10-# |
| B2 | X-533064-5-# |
| B4 | X-229064-10-# |
| B6 | X-394064-10-# |
| E | X-203064-10-# |
| L1 | X-080080-10-# |
| M | X-381064-10S1-9 |
| L2 | X-064064-10-# |
| L3 | X-095095-10-# |
| R1 | X-508254-4-# |
| R2 | X-673254-3-# |
| R3 | X-508318-3-# |
| R4 | X-673349-3-# |
| R5 | X-762508-1-# |
| R7 | X-165101-1-# |
| V1 | X-127111-10-# |
| Y3 | X-215055-10-# |
| Y5 | X-115064-10-# |
| Y6 | X-154064-10-# |
| Y7 | X-293064-10-# |
| Y8 | X-711064-5-# |
| Y9 | X-121064-10-# |
| Y10 | X-102070-10-# |
| Y12 | X-159079-10-# |
| Y13 | X-533114-5-# |
| Y14 | X-572286-2.5-# |
| Y15 | X-699318-2.5-# |

X = Insert material code from table below left.

= Insert color code from table below.

Material codes - thermal transfer labels

| | |
|---|--|
| CP = Clear polyester | T1K = Standard polyimide (Kapton®) 1 mil |
| EP = Paper | T2K = High-performance polyimide (Kapton®) 2 mil |
| HM = High tack metalized polyester | T2Y = Modified polyimide |
| HW = High tack white polyester | TAK = Amber polyimide (Kapton®) 2 mil |
| MP = Metalized polyester | TN = Tamper-proof polyethylene |
| MV = Tamper-evident metalized polyester | TSK = Static-safe polyimide (Kapton®) |
| NC = Nylon cloth | WP = White polyester |
| PVF = Polyvinyl fluoride (Tedlar®) | WV = White vinyl |

Material codes - dot matrix labels

| | |
|---------------------|-----------------------------|
| C = Vinyl cloth | K = Tan polyimide (Kapton®) |
| E = White polyester | M = Metalized polyester |

Color codes

| | |
|------------|-------------|
| 0 = Black | 8 = Gray |
| 1 = Brown | 9 = White |
| 2 = Red | X = Clear |
| 3 = Orange | 1A = Tan |
| 4 = Yellow | 2L = Pink |
| 5 = Green | 3A = Amber |
| 6 = Blue | 8A = Silver |
| 7 = Violet | |

WP White polyester labels

Tyco WP is a thermal transfer printable white polyester film with a permanent acrylic adhesive. It is ideal for bar coding, PCB and component labeling, as well as general purpose labeling applications that require a high durability white label. WP is resistant to a variety of solvents while maintaining print quality. It is UL Listed and CSA Certified, and print performance and durability are guaranteed when used with Tyco's RHD series ribbon.

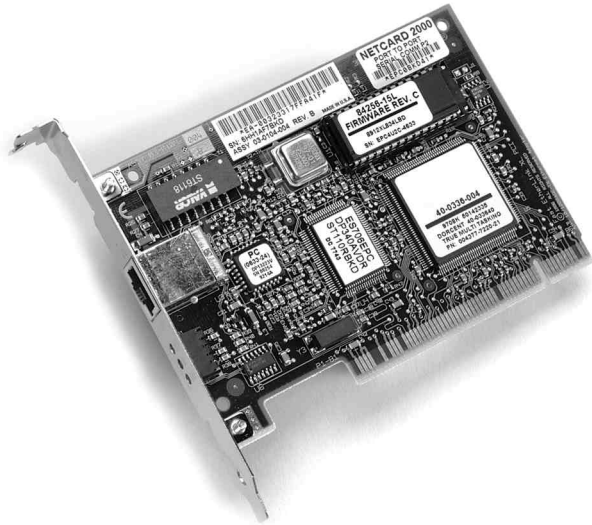

Features and benefits

- Thermal transfer printable.
- Excellent for use in PCB component labeling.
- Ink receptive topcoat.
- Excellent for bar code applications.
- UL Listed and CSA Certified.



| | | |
|----------------------------|--|-----------------|
| Adhesive | Permanent acrylic | |
| Service temperature | -40°C to +150°C | -40°F to +302°F |
| Recommended printer | T308S* | |
| Recommended ribbon | 1330-0607-10* | |
| | <small>*Alternative printers and ribbons are available for special applications. Contact Tyco Electronics Identification for more information.</small> | |

Part numbering system

WP-044033-10-9

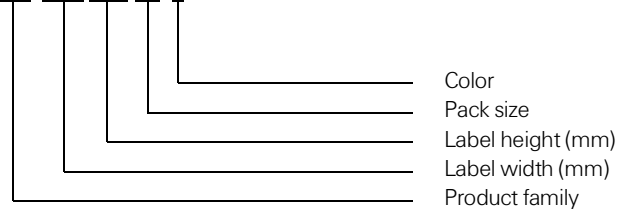

Ordering information

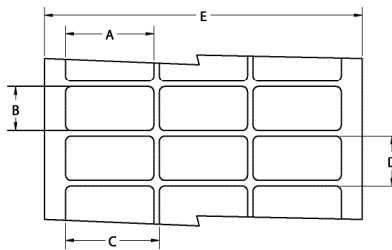

Product dimensions

| Product order code | Package quantity | Labels across | Label width (A) | | Label height (B) | | Horizontal repeat (C) | | Vertical repeat (D) | | Web width (E) | |
|--------------------|------------------|---------------|-----------------|---------------|------------------|---------------|-----------------------|---------------|---------------------|---------------|---------------|---------------|
| | | | mm | <i>inches</i> | mm | <i>inches</i> | mm | <i>inches</i> | mm | <i>inches</i> | mm | <i>inches</i> |
| WP-040040-25-9 | 25,000 | 20 | 4.0 | <i>0.157</i> | 4.0 | <i>0.157</i> | 4.0 | <i>0.157</i> | 7.2 | <i>0.281</i> | 86.0 | <i>3.380</i> |
| WP-044033-10-9 | 10,000 | 20 | 4.4 | <i>0.170</i> | 3.3 | <i>0.130</i> | 4.4 | <i>0.170</i> | 9.5 | <i>0.375</i> | 92.4 | <i>3.638</i> |
| WP-064064-25-9 | 25,000 | 12 | 6.4 | <i>0.250</i> | 6.4 | <i>0.250</i> | 6.4 | <i>0.250</i> | 9.5 | <i>0.375</i> | 82.2 | <i>3.240</i> |
| WP-080080-10-9 | 10,000 | 8 | 8.0 | <i>0.315</i> | 8.0 | <i>0.315</i> | 9.9 | <i>0.390</i> | 13.3 | <i>0.525</i> | 83.3 | <i>3.280</i> |
| WP-089047-10-9 | 10,000 | 5 | 8.9 | <i>0.350</i> | 4.7 | <i>0.185</i> | 11.4 | <i>0.450</i> | 7.9 | <i>0.313</i> | 60.6 | <i>2.386</i> |
| WP-095080-25-9 | 25,000 | 5 | 9.5 | <i>0.375</i> | 8.0 | <i>0.315</i> | 12.2 | <i>0.480</i> | 12.7 | <i>0.500</i> | 64.3 | <i>2.531</i> |
| WP-095095-10-9 | 10,000 | 7 | 9.5 | <i>0.375</i> | 9.5 | <i>0.375</i> | 11.1 | <i>0.437</i> | 12.7 | <i>0.500</i> | 82.1 | <i>3.230</i> |
| WP-114040-25-9 | 25,000 | 6 | 11.4 | <i>0.450</i> | 4.0 | <i>0.157</i> | 11.4 | <i>0.450</i> | 7.2 | <i>0.281</i> | 74.6 | <i>2.940</i> |
| WP-127032-10-9 | 10,000 | 5 | 12.7 | <i>0.500</i> | 3.2 | <i>0.125</i> | 19.1 | <i>0.750</i> | 3.2 | <i>0.250</i> | 94.9 | <i>3.736</i> |

(continued)

Product dimensions (continued)

| Product order code | Package quantity | Labels across | Label width (A) mm <i>inches</i> | Label height (B) mm <i>inches</i> | Horizontal repeat (C) mm <i>inches</i> | Vertical repeat (D) mm <i>inches</i> | Web width (E) mm <i>inches</i> |
|--------------------|------------------|---------------|-------------------------------------|--------------------------------------|---|---|-----------------------------------|
| WP-127111-10-9 | 10,000 | 5 | 12.7 <i>0.500</i> | 11.1 <i>0.437</i> | 16.8 <i>0.662</i> | 14.3 <i>0.563</i> | 86.0 <i>3.380</i> |
| WP-127127-10-9 | 10,000 | 5 | 12.7 <i>0.500</i> | 12.7 <i>0.500</i> | 15.9 <i>0.625</i> | 15.9 <i>0.625</i> | 82.6 <i>3.250</i> |
| WP-165051-25-9 | 25,000 | 4 | 16.5 <i>0.650</i> | 5.1 <i>0.200</i> | 17.8 <i>0.700</i> | 8.3 <i>0.325</i> | 75.8 <i>2.990</i> |
| WP-165102-10-9 | 10,000 | 5 | 16.5 <i>0.650</i> | 10.2 <i>0.400</i> | 19.1 <i>0.750</i> | 13.8 <i>0.545</i> | 99.1 <i>3.900</i> |
| WP-171171-10-9 | 10,000 | 5 | 17.1 <i>0.674</i> | 17.1 <i>0.674</i> | 19.7 <i>0.774</i> | 20.3 <i>0.800</i> | 101.8 <i>4.006</i> |
| WP-178095-10-9 | 10,000 | 4 | 17.8 <i>0.700</i> | 9.5 <i>0.375</i> | 19.1 <i>0.750</i> | 12.7 <i>0.500</i> | 80.9 <i>3.190</i> |
| WP-191064-10-9 | 10,000 | 4 | 19.1 <i>0.750</i> | 6.4 <i>0.250</i> | 21.6 <i>0.850</i> | 9.5 <i>0.375</i> | 89.9 <i>3.540</i> |
| WP-191114-15-9 | 15,000 | 3 | 19.1 <i>0.750</i> | 11.4 <i>0.450</i> | 22.2 <i>0.875</i> | 14.7 <i>0.579</i> | 69.5 <i>2.736</i> |
| WP-191762-5-9 | 5,000 | 3 | 19.1 <i>0.750</i> | 76.2 <i>3.000</i> | 21.6 <i>0.850</i> | 88.9 <i>3.500</i> | 68.2 <i>2.686</i> |
| WP-203127-10-9 | 10,000 | 4 | 20.3 <i>0.800</i> | 12.7 <i>0.500</i> | 22.9 <i>0.900</i> | 15.9 <i>0.625</i> | 94.6 <i>3.730</i> |
| WP-208086-5-9 | 5,000 | 4 | 20.8 <i>0.820</i> | 8.6 <i>0.340</i> | 24.1 <i>0.950</i> | 12.7 <i>0.500</i> | 101.6 <i>4.000</i> |
| WP-222159-15-9 | 15,000 | 2 | 22.2 <i>0.875</i> | 15.9 <i>0.625</i> | 24.8 <i>0.975</i> | 19.1 <i>0.750</i> | 53.0 <i>2.086</i> |
| WP-229064-10-9 | 10,000 | 3 | 22.9 <i>0.900</i> | 6.4 <i>0.250</i> | 28.6 <i>1.125</i> | 9.5 <i>0.375</i> | 86.0 <i>3.390</i> |
| WP-250381-10-9 | 10,000 | 4 | 24.9 <i>0.980</i> | 38.1 <i>1.500</i> | 27.4 <i>1.080</i> | 47.6 <i>1.875</i> | 113.5 <i>4.470</i> |
| WP-254045-10-9 | 10,000 | 3 | 25.4 <i>1.000</i> | 4.6 <i>0.180</i> | 31.8 <i>1.250</i> | 8.5 <i>0.333</i> | 95.3 <i>3.750</i> |
| WP-254064-10-9 | 10,000 | 3 | 25.4 <i>1.000</i> | 6.4 <i>0.250</i> | 27.9 <i>1.100</i> | 9.5 <i>0.375</i> | 87.3 <i>3.436</i> |
| WP-254097-10-9 | 10,000 | 3 | 25.4 <i>1.000</i> | 9.7 <i>0.380</i> | 27.9 <i>1.100</i> | 12.7 <i>0.500</i> | 87.4 <i>3.440</i> |
| WP-254127-10-9 | 10,000 | 3 | 25.4 <i>1.000</i> | 12.7 <i>0.500</i> | 27.9 <i>1.100</i> | 16.9 <i>0.666</i> | 87.4 <i>3.440</i> |
| WP-254254-10-9 | 10,000 | 3 | 25.4 <i>1.000</i> | 25.4 <i>1.000</i> | 27.9 <i>1.100</i> | 28.6 <i>1.125</i> | 87.4 <i>3.440</i> |
| WP-305047-10-9 | 10,000 | 2 | 30.5 <i>1.200</i> | 4.7 <i>0.185</i> | 33.0 <i>1.300</i> | 7.8 <i>0.306</i> | 69.5 <i>2.736</i> |
| WP-318064-10-9 | 10,000 | 1 | 31.8 <i>1.250</i> | 6.4 <i>0.250</i> | N/A N/A | 9.5 <i>0.375</i> | 37.9 <i>1.490</i> |
| WP-318097-10-9 | 10,000 | 1 | 31.8 <i>1.250</i> | 9.7 <i>0.380</i> | N/A N/A | 12.7 <i>0.500</i> | 37.8 <i>1.488</i> |
| WP-381020-10-9 | 10,000 | 1 | 38.1 <i>1.500</i> | 2.0 <i>0.080</i> | N/A N/A | 10.7 <i>0.423</i> | 44.1 <i>1.740</i> |
| WP-381064-10-9 | 10,000 | 1 | 38.1 <i>1.500</i> | 6.4 <i>0.250</i> | N/A N/A | 9.5 <i>0.375</i> | 44.5 <i>1.750</i> |
| WP-381127-5-9 | 5,000 | 2 | 38.1 <i>1.500</i> | 12.7 <i>0.500</i> | 44.2 <i>1.740</i> | 15.9 <i>0.630</i> | 88.2 <i>3.470</i> |
| WP-381191-5-9 | 5,000 | 2 | 38.1 <i>1.500</i> | 19.1 <i>0.750</i> | 43.2 <i>1.700</i> | 22.2 <i>0.875</i> | 87.6 <i>3.450</i> |
| WP-381381-2.5-9 | 2,500 | 2 | 38.1 <i>1.500</i> | 38.1 <i>1.500</i> | 44.5 <i>1.750</i> | 40.8 <i>1.610</i> | 88.9 <i>3.500</i> |
| WP-381635-5-9 | 5,000 | 2 | 38.1 <i>1.500</i> | 63.5 <i>2.500</i> | 40.6 <i>1.600</i> | 66.7 <i>2.630</i> | 84.7 <i>3.340</i> |
| WP-406254-1.5-9 | 1,500 | 2 | 40.6 <i>1.600</i> | 25.4 <i>1.000</i> | 55.9 <i>2.200</i> | 38.1 <i>1.500</i> | 102.9 <i>4.050</i> |
| WP-445064-10-9 | 10,000 | 1 | 44.5 <i>1.750</i> | 6.4 <i>0.250</i> | N/A N/A | 9.5 <i>0.375</i> | 50.4 <i>1.986</i> |
| WP-445102-5-9 | 5,000 | 1 | 44.5 <i>1.750</i> | 10.2 <i>0.400</i> | N/A N/A | 12.7 <i>0.500</i> | 50.4 <i>1.986</i> |
| WP-445445-2-9 | 2,000 | 1 | 44.5 <i>1.750</i> | 44.5 <i>1.750</i> | N/A N/A | 47.6 <i>1.875</i> | 50.4 <i>1.986</i> |
| WP-478175-5-9 | 5,000 | 1 | 47.8 <i>1.880</i> | 17.5 <i>0.690</i> | N/A N/A | 24.4 <i>0.962</i> | 66.0 <i>2.600</i> |
| WP-508064-10-9 | 10,000 | 1 | 50.8 <i>2.000</i> | 6.4 <i>0.250</i> | N/A N/A | 9.5 <i>0.375</i> | 56.9 <i>2.240</i> |
| WP-508095-5-9 | 5,000 | 1 | 50.8 <i>2.000</i> | 9.5 <i>0.375</i> | N/A N/A | 12.7 <i>0.500</i> | 57.2 <i>2.250</i> |
| WP-508127-10-9 | 10,000 | 1 | 50.8 <i>2.000</i> | 12.7 <i>0.500</i> | N/A N/A | 15.9 <i>0.625</i> | 56.9 <i>2.240</i> |
| WP-508254-5-9 | 5,000 | 1 | 50.8 <i>2.000</i> | 25.4 <i>1.000</i> | N/A N/A | 28.6 <i>1.125</i> | 57.2 <i>2.250</i> |
| WP-508318-2.5-9 | 2,500 | 1 | 50.8 <i>2.000</i> | 31.8 <i>1.250</i> | N/A N/A | 34.9 <i>1.375</i> | 56.9 <i>2.240</i> |
| WP-508508-3-9 | 3,000 | 1 | 50.8 <i>2.000</i> | 50.8 <i>2.000</i> | N/A N/A | 54.6 <i>2.150</i> | 54.0 <i>2.130</i> |
| WP-523841-1.5-9 | 1,500 | 1 | 52.3 <i>2.060</i> | 84.1 <i>3.310</i> | N/A N/A | 88.9 <i>3.500</i> | 58.2 <i>2.290</i> |
| WP-610419-2.5-9 | 2,500 | 1 | 61.0 <i>2.400</i> | 41.9 <i>1.650</i> | N/A N/A | 45.5 <i>1.792</i> | 67.3 <i>2.650</i> |
| WP-699191-5-9 | 5,000 | 1 | 69.9 <i>2.750</i> | 19.1 <i>0.750</i> | N/A N/A | 23.3 <i>0.917</i> | 76.2 <i>3.000</i> |
| WP-699254-5-9 | 5,000 | 1 | 69.9 <i>2.750</i> | 25.4 <i>1.000</i> | N/A N/A | 28.6 <i>1.125</i> | 76.2 <i>3.000</i> |
| WP-762381-2.5-9 | 2,500 | 1 | 76.2 <i>3.000</i> | 38.1 <i>1.500</i> | N/A N/A | 41.3 <i>1.625</i> | 82.3 <i>3.240</i> |
| WP-762508-2.5-9 | 2,500 | 1 | 76.2 <i>3.000</i> | 50.8 <i>2.000</i> | N/A N/A | 54.0 <i>2.125</i> | 82.6 <i>3.240</i> |
| WP-762127-1-9 | 1,000 | 1 | 76.2 <i>3.000</i> | 127.0 <i>5.000</i> | N/A N/A | 129.5 <i>5.100</i> | 79.4 <i>3.130</i> |
| WP-101508-2.5-9 | 2,500 | 1 | 101.6 <i>4.000</i> | 50.8 <i>2.000</i> | N/A N/A | 54.6 <i>2.150</i> | 104.1 <i>4.100</i> |
| WP-101635-2.5-9 | 2,500 | 1 | 101.6 <i>4.000</i> | 63.5 <i>2.500</i> | N/A N/A | 66.7 <i>2.625</i> | 107.7 <i>4.240</i> |
| WP-101762-1.8-9 | 1,800 | 1 | 101.6 <i>4.000</i> | 76.2 <i>3.000</i> | N/A N/A | 79.4 <i>3.125</i> | 104.1 <i>4.100</i> |
| WP-101101-1.3-9 | 1,300 | 1 | 101.6 <i>4.000</i> | 101.6 <i>4.000</i> | N/A N/A | 104.8 <i>4.125</i> | 104.1 <i>4.100</i> |
| WP-101165-0.85-9 | 850 | 1 | 101.6 <i>4.000</i> | 165.1 <i>6.500</i> | N/A N/A | 168.3 <i>6.680</i> | 104.9 <i>4.130</i> |

CP Clear polyester labels

Tyco CP is a clear polyester film with a permanent acrylic adhesive. CP is ideal for use as an over-laminate to further protect printed labels from chemicals, solvents, abrasion, heat and moisture.

Features and benefits

- Ideal for applications where either a clear label or laminate is required.



| | | |
|----------------------------|-------------------|-----------------|
| Adhesive | Permanent acrylic | |
| Service temperature | -40°C to +150°C | -40°F to +302°F |

Part numbering system



Ordering information

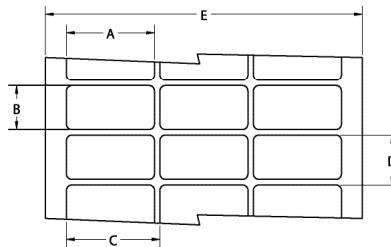

Product dimensions

| Product order code | Package quantity | Labels across | Label width (A) mm <i>inches</i> | Label height (B) mm <i>inches</i> | Horizontal repeat (C) mm <i>inches</i> | Vertical repeat (D) mm <i>inches</i> | Web width (E) mm <i>inches</i> |
|--------------------|------------------|---------------|-------------------------------------|--------------------------------------|---|---|-----------------------------------|
| CP-040040-25-X | 25,000 | 20 | 4.0 <i>0.157</i> | 4.0 <i>0.157</i> | 4.0 <i>0.157</i> | 7.2 <i>0.281</i> | 86.0 <i>3.380</i> |
| CP-044033-10-X | 10,000 | 20 | 4.4 <i>0.170</i> | 3.3 <i>0.130</i> | 4.4 <i>0.170</i> | 9.5 <i>0.375</i> | 92.4 <i>3.636</i> |
| CP-064064-25-X | 25,000 | 12 | 6.4 <i>0.250</i> | 6.4 <i>0.250</i> | 6.4 <i>0.250</i> | 9.5 <i>0.375</i> | 82.2 <i>3.240</i> |
| CP-080080-10-X | 10,000 | 8 | 8.0 <i>0.315</i> | 8.0 <i>0.315</i> | 9.9 <i>0.390</i> | 13.3 <i>0.525</i> | 83.3 <i>3.280</i> |
| CP-089047-10-X | 10,000 | 5 | 8.9 <i>0.350</i> | 4.7 <i>0.185</i> | 11.4 <i>0.450</i> | 7.9 <i>0.313</i> | 60.6 <i>2.386</i> |
| CP-095080-25-X | 25,000 | 5 | 9.5 <i>0.375</i> | 8.0 <i>0.315</i> | 12.2 <i>0.480</i> | 12.7 <i>0.500</i> | 64.3 <i>2.531</i> |
| CP-095095-10-X | 10,000 | 7 | 9.5 <i>0.375</i> | 9.5 <i>0.375</i> | 11.1 <i>0.437</i> | 12.7 <i>0.500</i> | 82.1 <i>3.230</i> |
| CP-114040-25-X | 25,000 | 6 | 11.4 <i>0.450</i> | 4.0 <i>0.157</i> | 11.4 <i>0.450</i> | 7.2 <i>0.281</i> | 74.6 <i>2.940</i> |
| CP-127032-10-X | 10,000 | 5 | 12.7 <i>0.500</i> | 3.2 <i>0.125</i> | 19.1 <i>0.750</i> | 3.2 <i>0.250</i> | 94.9 <i>3.736</i> |

(continued)

Product dimensions (continued)

| Product order code | Package quantity | Labels across | Label width (A) mm inches | Label height (B) mm inches | Horizontal repeat (C) mm inches | Vertical repeat (D) mm inches | Web width (E) mm inches |
|--------------------|------------------|---------------|------------------------------|-------------------------------|------------------------------------|----------------------------------|----------------------------|
| CP-127111-10-X | 10,000 | 5 | 12.7 0.500 | 11.1 0.437 | 16.8 0.662 | 14.3 0.563 | 86.0 3.380 |
| CP-127127-10-X | 10,000 | 5 | 12.7 0.500 | 12.7 0.500 | 15.9 0.625 | 15.9 0.625 | 82.6 3.250 |
| CP-165051-25-X | 25,000 | 4 | 16.5 0.650 | 5.1 0.200 | 17.8 0.700 | 8.3 0.325 | 75.8 2.990 |
| CP-165102-10-X | 10,000 | 5 | 16.5 0.650 | 10.2 0.400 | 19.1 0.750 | 13.8 0.545 | 99.1 3.900 |
| CP-171171-10-X | 10,000 | 5 | 17.1 0.674 | 17.1 0.674 | 19.7 0.774 | 20.3 0.800 | 101.8 4.006 |
| CP-178095-10-X | 10,000 | 4 | 17.8 0.700 | 9.5 0.375 | 19.1 0.750 | 12.7 0.500 | 80.9 3.190 |
| CP-191064-10-X | 10,000 | 4 | 19.1 0.750 | 6.4 0.250 | 21.6 0.850 | 9.5 0.375 | 89.9 3.540 |
| CP-191114-15-X | 15,000 | 3 | 19.1 0.750 | 11.4 0.450 | 22.2 0.875 | 14.7 0.579 | 69.5 2.736 |
| CP-191762-5-X | 5,000 | 3 | 19.1 0.750 | 76.2 3.000 | 21.6 0.850 | 88.9 3.500 | 68.2 2.686 |
| CP-203127-10-X | 10,000 | 4 | 20.3 0.800 | 12.7 0.500 | 22.9 0.900 | 15.9 0.625 | 94.6 3.730 |
| CP-208086-5-X | 5,000 | 4 | 20.8 0.820 | 8.6 0.340 | 24.1 0.950 | 12.7 0.500 | 101.6 4.000 |
| CP-222159-15-X | 15,000 | 2 | 22.2 0.875 | 15.9 0.625 | 24.8 0.975 | 19.1 0.750 | 53.0 2.086 |
| CP-229064-10-X | 10,000 | 3 | 22.9 0.900 | 6.4 0.250 | 28.6 1.125 | 9.5 0.375 | 86.0 3.390 |
| CP-250381-10-X | 10,000 | 4 | 24.9 0.980 | 38.1 1.500 | 27.4 1.080 | 47.6 1.875 | 113.5 4.470 |
| CP-254045-10-X | 10,000 | 3 | 25.4 1.000 | 4.6 0.180 | 31.8 1.250 | 8.5 0.333 | 95.3 3.750 |
| CP-254064-10-X | 10,000 | 3 | 25.4 1.000 | 6.4 0.250 | 27.9 1.100 | 9.5 0.375 | 87.3 3.436 |
| CP-254097-10-X | 10,000 | 3 | 25.4 1.000 | 9.7 0.380 | 27.9 1.100 | 12.7 0.500 | 87.4 3.440 |
| CP-254127-10-X | 10,000 | 3 | 25.4 1.000 | 12.7 0.500 | 27.9 1.100 | 16.9 0.666 | 87.4 3.440 |
| CP-254254-10-X | 10,000 | 3 | 25.4 1.000 | 25.4 1.000 | 27.9 1.100 | 28.6 1.125 | 87.4 3.440 |
| CP-305047-10-X | 10,000 | 2 | 30.5 1.200 | 4.7 0.185 | 33.0 1.300 | 7.8 0.306 | 69.5 2.736 |
| CP-318064-10-X | 10,000 | 1 | 31.8 1.250 | 6.4 0.250 | N/A N/A | 9.5 0.375 | 37.9 1.490 |
| CP-318097-10-X | 10,000 | 1 | 31.8 1.250 | 9.7 0.380 | N/A N/A | 12.7 0.500 | 37.8 1.488 |
| CP-381020-10-X | 10,000 | 1 | 38.1 1.500 | 2.0 0.080 | N/A N/A | 10.7 0.423 | 44.1 1.740 |
| CP-381064-10-X | 10,000 | 1 | 38.1 1.500 | 6.4 0.250 | N/A N/A | 9.5 0.375 | 44.5 1.750 |
| CP-381127-5-X | 5,000 | 2 | 38.1 1.500 | 12.7 0.500 | 44.2 1.738 | 15.9 0.625 | 88.2 3.472 |
| CP-381191-5-X | 5,000 | 2 | 38.1 1.500 | 19.1 0.750 | 43.2 1.700 | 22.2 0.875 | 87.6 3.450 |
| CP-381381-2.5-X | 2,500 | 2 | 38.1 1.500 | 38.1 1.500 | 44.5 1.750 | 40.8 1.607 | 88.9 3.500 |
| CP-381635-5-X | 5,000 | 2 | 38.1 1.500 | 63.5 2.500 | 40.6 1.600 | 66.7 2.625 | 84.7 3.336 |
| CP-406254-1.5-X | 1,500 | 2 | 40.6 1.600 | 25.4 1.000 | 55.9 2.200 | 38.1 1.500 | 102.9 4.050 |
| CP-445064-10-X | 10,000 | 1 | 44.5 1.750 | 6.4 0.250 | N/A N/A | 9.5 0.375 | 50.4 1.986 |
| CP-445102-5-X | 5,000 | 1 | 44.5 1.750 | 10.2 0.400 | N/A N/A | 12.7 0.500 | 50.4 1.986 |
| CP-445445-2-X | 2,000 | 1 | 44.5 1.750 | 44.5 1.750 | N/A N/A | 47.6 1.875 | 50.4 1.986 |
| CP-478175-5-X | 5,000 | 1 | 47.8 1.880 | 17.5 0.690 | N/A N/A | 24.4 0.962 | 66.0 2.600 |
| CP-508064-10-X | 10,000 | 1 | 50.8 2.000 | 6.4 0.250 | N/A N/A | 9.5 0.375 | 56.9 2.240 |
| CP-508095-5-X | 5,000 | 1 | 50.8 2.000 | 9.5 0.375 | N/A N/A | 12.7 0.500 | 57.2 2.250 |
| CP-508127-10-X | 10,000 | 1 | 50.8 2.000 | 12.7 0.500 | N/A N/A | 15.9 0.625 | 56.9 2.240 |
| CP-508254-5-X | 5,000 | 1 | 50.8 2.000 | 25.4 1.000 | N/A N/A | 28.6 1.125 | 57.2 2.250 |
| CP-508318-2.5-X | 2,500 | 1 | 50.8 2.000 | 31.8 1.250 | N/A N/A | 34.9 1.375 | 56.9 2.240 |
| CP-508508-3-X | 3,000 | 1 | 50.8 2.000 | 50.8 2.000 | N/A N/A | 54.6 2.150 | 54.0 2.130 |
| CP-523841-1.5-X | 1,500 | 1 | 52.3 2.060 | 84.1 3.310 | N/A N/A | 88.9 3.500 | 58.2 2.290 |
| CP-610419-2.5-X | 2,500 | 1 | 61.0 2.400 | 41.9 1.650 | N/A N/A | 45.5 1.792 | 67.3 2.650 |
| CP-699191-5-X | 5,000 | 1 | 69.9 2.750 | 19.1 0.750 | N/A N/A | 23.3 0.917 | 76.2 3.000 |
| CP-699254-5-X | 5,000 | 1 | 69.9 2.750 | 25.4 1.000 | N/A N/A | 28.6 1.125 | 76.2 3.000 |
| CP-762381-2.5-X | 2,500 | 1 | 76.2 3.000 | 38.1 1.500 | N/A N/A | 41.3 1.625 | 82.3 3.240 |
| CP-762508-2.5-X | 2,500 | 1 | 76.2 3.000 | 50.8 2.000 | N/A N/A | 54.0 2.125 | 82.6 3.240 |
| CP-762127-1-X | 1,000 | 1 | 76.2 3.000 | 127.0 5.000 | N/A N/A | 129.5 5.100 | 79.4 3.130 |
| CP-101508-2.5-X | 2,500 | 1 | 101.6 4.000 | 50.8 2.000 | N/A N/A | 54.6 2.150 | 104.1 4.100 |
| CP-101635-2.5-X | 2,500 | 1 | 101.6 4.000 | 63.5 2.500 | N/A N/A | 66.7 2.625 | 107.7 4.240 |
| CP-101762-1.8-X | 1,800 | 1 | 101.6 4.000 | 76.2 3.000 | N/A N/A | 79.4 3.125 | 104.1 4.100 |
| CP-101101-1.3-X | 1,300 | 1 | 101.6 4.000 | 101.6 4.000 | N/A N/A | 104.8 4.125 | 104.1 4.100 |
| CP-101165-0.85-X | 850 | 1 | 101.6 4.000 | 165.1 6.500 | N/A N/A | 168.3 6.680 | 104.9 4.130 |



Electronics

Thermal Transfer

HW High tack white polyester labels

Tyco HW is a thermal transfer printable white polyester film with a high tack permanent acrylic adhesive. Designed for application to rough surfaces or where increased adhesion is required, HW is also excellent for bar-coding, electronic PCB, component and general labeling applications. The high tack adhesion of HW will bond to the most demanding surfaces, including textured and contoured surfaces. For guaranteed print performance and durability, use with Tyco's RHD series ribbon.



Features and benefits

- Thermal transfer printable.
- Aggressive adhesive for textured and powdered surfaces.
- UL Listed and CSA Certified.



| | | |
|----------------------------|--|-----------------|
| Adhesive | Permanent acrylic | |
| Service temperature | -40°C to +150°C | -40°F to +302°F |
| Recommended printer | T308S* | |
| Recommended ribbon | 1330-0607-10* | |
| | <i>*Alternative printers and ribbons are available for special applications. Contact Tyco Electronics Identification for more information.</i> | |

Part numbering system

HW-044033-10-9

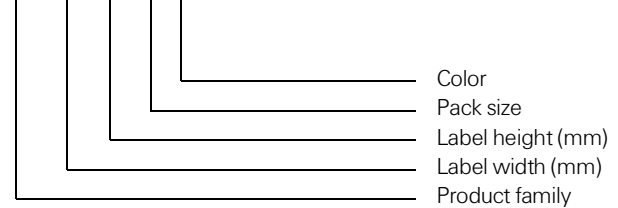

Ordering information

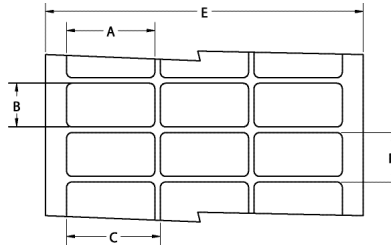

Product dimensions

| Product order code | Package quantity | Labels across | Label width (A) | | Label height (B) | | Horizontal repeat (C) | | Vertical repeat (D) | | Web width (E) | |
|--------------------|------------------|---------------|-----------------|---------------|------------------|---------------|-----------------------|---------------|---------------------|---------------|---------------|---------------|
| | | | mm | <i>inches</i> | mm | <i>inches</i> | mm | <i>inches</i> | mm | <i>inches</i> | mm | <i>inches</i> |
| HW-040040-25-9 | 25,000 | 20 | 4.0 | <i>0.157</i> | 4.0 | <i>0.157</i> | 4.0 | <i>0.157</i> | 7.2 | <i>0.281</i> | 86.0 | <i>3.380</i> |
| HW-044033-10-9 | 10,000 | 20 | 4.4 | <i>0.170</i> | 3.3 | <i>0.130</i> | 4.4 | <i>0.170</i> | 9.5 | <i>0.375</i> | 92.4 | <i>3.636</i> |
| HW-064064-25-9 | 25,000 | 12 | 6.4 | <i>0.250</i> | 6.4 | <i>0.250</i> | 6.4 | <i>0.250</i> | 9.5 | <i>0.375</i> | 82.2 | <i>3.240</i> |
| HW-080080-10-9 | 10,000 | 8 | 8.0 | <i>0.315</i> | 8.0 | <i>0.315</i> | 9.9 | <i>0.390</i> | 13.3 | <i>0.525</i> | 83.3 | <i>3.280</i> |
| HW-089047-10-9 | 10,000 | 5 | 8.9 | <i>0.350</i> | 4.7 | <i>0.186</i> | 11.4 | <i>0.450</i> | 7.9 | <i>0.313</i> | 60.6 | <i>2.386</i> |
| HW-095080-25-9 | 25,000 | 5 | 9.5 | <i>0.375</i> | 8.0 | <i>0.315</i> | 12.2 | <i>0.480</i> | 12.7 | <i>0.500</i> | 64.3 | <i>2.531</i> |
| HW-095095-10-9 | 10,000 | 7 | 9.5 | <i>0.375</i> | 9.5 | <i>0.375</i> | 11.1 | <i>0.437</i> | 12.7 | <i>0.500</i> | 82.1 | <i>3.230</i> |
| HW-114040-25-9 | 25,000 | 6 | 11.4 | <i>0.450</i> | 4.0 | <i>0.157</i> | 11.4 | <i>0.450</i> | 7.2 | <i>0.281</i> | 74.6 | <i>2.940</i> |
| HW-127032-10-9 | 10,000 | 5 | 12.7 | <i>0.500</i> | 3.2 | <i>0.125</i> | 19.1 | <i>0.750</i> | 3.2 | <i>0.250</i> | 94.9 | <i>3.736</i> |

(continued)

Product dimensions (continued)

| Product order code | Package quantity | Labels across | Label width (A) mm <i>inches</i> | Label height (B) mm <i>inches</i> | Horizontal repeat (C) mm <i>inches</i> | Vertical repeat (D) mm <i>inches</i> | Web width (E) mm <i>inches</i> |
|--------------------|------------------|---------------|-------------------------------------|--------------------------------------|---|---|-----------------------------------|
| HW-127111-10-9 | 10,000 | 5 | 12.7 <i>0.500</i> | 11.1 <i>0.437</i> | 16.8 <i>0.662</i> | 14.3 <i>0.563</i> | 86.0 <i>3.380</i> |
| HW-127127-10-9 | 10,000 | 5 | 12.7 <i>0.500</i> | 12.7 <i>0.500</i> | 15.9 <i>0.625</i> | 15.9 <i>0.625</i> | 82.6 <i>3.250</i> |
| HW-165051-25-9 | 25,000 | 4 | 16.5 <i>0.650</i> | 5.1 <i>0.200</i> | 17.8 <i>0.700</i> | 8.3 <i>0.325</i> | 75.8 <i>2.990</i> |
| HW-165102-10-9 | 10,000 | 5 | 16.5 <i>0.650</i> | 10.2 <i>0.400</i> | 19.1 <i>0.750</i> | 13.8 <i>0.545</i> | 99.1 <i>3.900</i> |
| HW-171171-10-9 | 10,000 | 5 | 17.1 <i>0.674</i> | 17.1 <i>0.674</i> | 19.7 <i>0.774</i> | 20.3 <i>0.800</i> | 101.8 <i>4.006</i> |
| HW-178095-10-9 | 10,000 | 4 | 17.8 <i>0.700</i> | 9.5 <i>0.375</i> | 19.1 <i>0.750</i> | 12.7 <i>0.500</i> | 80.9 <i>3.190</i> |
| HW-191064-10-9 | 10,000 | 4 | 19.1 <i>0.750</i> | 6.4 <i>0.250</i> | 21.6 <i>0.850</i> | 9.5 <i>0.375</i> | 89.9 <i>3.540</i> |
| HW-191114-15-9 | 15,000 | 3 | 19.1 <i>0.750</i> | 11.4 <i>0.450</i> | 22.2 <i>0.875</i> | 14.7 <i>0.579</i> | 69.5 <i>2.736</i> |
| HW-191762-5-9 | 5,000 | 3 | 19.1 <i>0.750</i> | 76.2 <i>3.000</i> | 21.6 <i>0.850</i> | 88.9 <i>3.500</i> | 68.2 <i>2.688</i> |
| HW-203127-10-9 | 10,000 | 4 | 20.3 <i>0.800</i> | 12.7 <i>0.500</i> | 22.9 <i>0.900</i> | 15.9 <i>0.625</i> | 94.6 <i>3.730</i> |
| HW-208086-5-9 | 5,000 | 4 | 20.8 <i>0.820</i> | 8.6 <i>0.340</i> | 24.1 <i>0.950</i> | 12.7 <i>0.500</i> | 101.6 <i>4.000</i> |
| HW-222159-15-9 | 15,000 | 2 | 22.2 <i>0.875</i> | 15.9 <i>0.625</i> | 24.8 <i>0.975</i> | 19.1 <i>0.750</i> | 53.0 <i>2.086</i> |
| HW-229064-10-9 | 10,000 | 3 | 22.9 <i>0.900</i> | 6.4 <i>0.250</i> | 28.6 <i>1.125</i> | 9.5 <i>0.375</i> | 86.0 <i>3.390</i> |
| HW-250381-10-9 | 10,000 | 4 | 24.9 <i>0.980</i> | 38.1 <i>1.500</i> | 27.4 <i>1.080</i> | 47.6 <i>1.875</i> | 113.5 <i>4.470</i> |
| HW-254045-10-9 | 10,000 | 3 | 25.4 <i>1.000</i> | 4.6 <i>0.180</i> | 31.8 <i>1.250</i> | 8.5 <i>0.333</i> | 95.3 <i>3.750</i> |
| HW-254064-10-9 | 10,000 | 3 | 25.4 <i>1.000</i> | 6.4 <i>0.250</i> | 27.9 <i>1.100</i> | 9.5 <i>0.375</i> | 87.3 <i>3.436</i> |
| HW-254097-10-9 | 10,000 | 3 | 25.4 <i>1.000</i> | 9.7 <i>0.380</i> | 27.9 <i>1.100</i> | 12.7 <i>0.500</i> | 87.4 <i>3.440</i> |
| HW-254127-10-9 | 10,000 | 3 | 25.4 <i>1.000</i> | 12.7 <i>0.500</i> | 27.9 <i>1.100</i> | 16.9 <i>0.666</i> | 87.4 <i>3.440</i> |
| HW-254254-10-9 | 10,000 | 3 | 25.4 <i>1.000</i> | 25.4 <i>1.000</i> | 27.9 <i>1.100</i> | 28.6 <i>1.125</i> | 87.4 <i>3.440</i> |
| HW-305047-10-9 | 10,000 | 2 | 30.5 <i>1.200</i> | 4.7 <i>0.185</i> | 33.0 <i>1.300</i> | 7.8 <i>0.306</i> | 69.5 <i>2.736</i> |
| HW-318064-10-9 | 10,000 | 1 | 31.8 <i>1.250</i> | 6.4 <i>0.250</i> | N/A N/A | 9.5 <i>0.375</i> | 37.9 <i>1.490</i> |
| HW-318097-10-9 | 10,000 | 1 | 31.8 <i>1.250</i> | 9.7 <i>0.380</i> | N/A N/A | 12.7 <i>0.500</i> | 37.8 <i>1.488</i> |
| HW-381020-10-9 | 10,000 | 1 | 38.1 <i>1.500</i> | 2.0 <i>0.080</i> | N/A N/A | 10.7 <i>0.423</i> | 44.1 <i>1.740</i> |
| HW-381064-10-9 | 10,000 | 1 | 38.1 <i>1.500</i> | 6.4 <i>0.250</i> | N/A N/A | 9.5 <i>0.375</i> | 44.5 <i>1.750</i> |
| HW-381127-5-9 | 5,000 | 2 | 38.1 <i>1.500</i> | 12.7 <i>0.500</i> | 44.2 <i>1.738</i> | 15.9 <i>0.625</i> | 88.2 <i>3.472</i> |
| HW-381191-5-9 | 5,000 | 2 | 38.1 <i>1.500</i> | 19.1 <i>0.750</i> | 43.2 <i>1.700</i> | 22.2 <i>0.875</i> | 87.6 <i>3.450</i> |
| HW-381381-2.5-9 | 2,500 | 2 | 38.1 <i>1.500</i> | 38.1 <i>1.500</i> | 44.5 <i>1.750</i> | 40.8 <i>1.607</i> | 88.9 <i>3.500</i> |
| HW-381635-5-9 | 5,000 | 2 | 38.1 <i>1.500</i> | 63.5 <i>2.500</i> | 40.6 <i>1.600</i> | 66.7 <i>2.625</i> | 84.7 <i>3.338</i> |
| HW-406254-1.5-9 | 1,500 | 2 | 40.6 <i>1.600</i> | 25.4 <i>1.000</i> | 55.9 <i>2.200</i> | 38.1 <i>1.500</i> | 102.9 <i>4.050</i> |
| HW-445064-10-9 | 10,000 | 1 | 44.5 <i>1.750</i> | 6.4 <i>0.250</i> | N/A N/A | 9.5 <i>0.375</i> | 50.4 <i>1.986</i> |
| HW-445102-5-9 | 5,000 | 1 | 44.5 <i>1.750</i> | 10.2 <i>0.400</i> | N/A N/A | 12.7 <i>0.500</i> | 50.4 <i>1.986</i> |
| HW-445445-2-9 | 2,000 | 1 | 44.5 <i>1.750</i> | 44.5 <i>1.750</i> | N/A N/A | 47.6 <i>1.875</i> | 50.4 <i>1.986</i> |
| HW-478175-5-9 | 5,000 | 1 | 47.8 <i>1.880</i> | 17.5 <i>0.690</i> | N/A N/A | 24.4 <i>0.962</i> | 66.0 <i>2.600</i> |
| HW-508064-10-9 | 10,000 | 1 | 50.8 <i>2.000</i> | 6.4 <i>0.250</i> | N/A N/A | 9.5 <i>0.375</i> | 56.9 <i>2.240</i> |
| HW-508095-5-9 | 5,000 | 1 | 50.8 <i>2.000</i> | 9.5 <i>0.375</i> | N/A N/A | 12.7 <i>0.500</i> | 57.2 <i>2.250</i> |
| HW-508127-10-9 | 10,000 | 1 | 50.8 <i>2.000</i> | 12.7 <i>0.500</i> | N/A N/A | 15.9 <i>0.625</i> | 56.9 <i>2.240</i> |
| HW-508254-5-9 | 5,000 | 1 | 50.8 <i>2.000</i> | 25.4 <i>1.000</i> | N/A N/A | 28.6 <i>1.125</i> | 57.2 <i>2.250</i> |
| HW-508318-2.5-9 | 2,500 | 1 | 50.8 <i>2.000</i> | 31.8 <i>1.250</i> | N/A N/A | 34.9 <i>1.375</i> | 56.9 <i>2.240</i> |
| HW-508508-3-9 | 3,000 | 1 | 50.8 <i>2.000</i> | 50.8 <i>2.000</i> | N/A N/A | 54.6 <i>2.150</i> | 54.0 <i>2.130</i> |
| HW-523841-1.5-9 | 1,500 | 1 | 52.3 <i>2.060</i> | 84.1 <i>3.310</i> | N/A N/A | 88.9 <i>3.500</i> | 58.2 <i>2.290</i> |
| HW-610419-2.5-9 | 2,500 | 1 | 61.0 <i>2.400</i> | 41.9 <i>1.650</i> | N/A N/A | 45.5 <i>1.792</i> | 67.3 <i>2.650</i> |
| HW-699191-5-9 | 5,000 | 1 | 69.9 <i>2.750</i> | 19.1 <i>0.750</i> | N/A N/A | 23.3 <i>0.917</i> | 76.2 <i>3.000</i> |
| HW-699254-5-9 | 5,000 | 1 | 69.9 <i>2.750</i> | 25.4 <i>1.000</i> | N/A N/A | 28.6 <i>1.125</i> | 76.2 <i>3.000</i> |
| HW-762381-2.5-9 | 2,500 | 1 | 76.2 <i>3.000</i> | 38.1 <i>1.500</i> | N/A N/A | 41.3 <i>1.625</i> | 82.3 <i>3.240</i> |
| HW-762508-2.5-9 | 2,500 | 1 | 76.2 <i>3.000</i> | 50.8 <i>2.000</i> | N/A N/A | 54.0 <i>2.125</i> | 82.6 <i>3.240</i> |
| HW-762127-1-9 | 1,000 | 1 | 76.2 <i>3.000</i> | 127.0 <i>5.000</i> | N/A N/A | 129.5 <i>5.100</i> | 79.4 <i>3.130</i> |
| HW-101508-2.5-9 | 2,500 | 1 | 101.6 <i>4.000</i> | 50.8 <i>2.000</i> | N/A N/A | 54.6 <i>2.150</i> | 104.1 <i>4.100</i> |
| HW-101635-2.5-9 | 2,500 | 1 | 101.6 <i>4.000</i> | 63.5 <i>2.500</i> | N/A N/A | 66.7 <i>2.625</i> | 107.7 <i>4.240</i> |
| HW-101762-1.8-9 | 1,800 | 1 | 101.6 <i>4.000</i> | 76.2 <i>3.000</i> | N/A N/A | 79.4 <i>3.125</i> | 104.1 <i>4.100</i> |
| HW-101101-1.3-9 | 1,300 | 1 | 101.6 <i>4.000</i> | 101.6 <i>4.000</i> | N/A N/A | 104.8 <i>4.125</i> | 104.1 <i>4.100</i> |
| HW-101165-0.85-9 | 850 | 1 | 101.6 <i>4.000</i> | 165.1 <i>6.500</i> | N/A N/A | 168.3 <i>6.680</i> | 104.9 <i>4.130</i> |



Electronics

Thermal Transfer

HM High tack metalized polyester labels

Tyco HM is a thermal transfer printable metalized polyester film with a high tack permanent acrylic adhesive, designed for application to rough surfaces or where increased adhesion is required, and applications that require a metal look such as rating plates. The high tack adhesion of HM will bond to the most demanding surfaces, including textured and contoured surfaces. For guaranteed print performance and durability, use with Tyco's RHD series ribbon.

Features and benefits

- Thermal transfer printable.
- Aggressive adhesive which permanently bonds to both high and low surface energy plastics.
- UL Listed and CSA Certified.

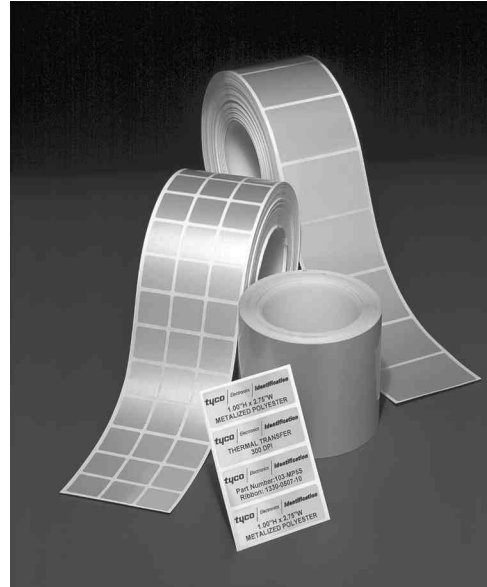

| | |
|----------------------------|---------------------------------|
| Adhesive | Permanent acrylic |
| Service temperature | -40°C to +150°C -40°F to +302°F |
| Recommended printer | T308S* |
| Recommended ribbon | 1330-0607-10* |

*Alternative printers and ribbons are available for special applications. Contact Tyco Electronics Identification for more information.

Part numbering system

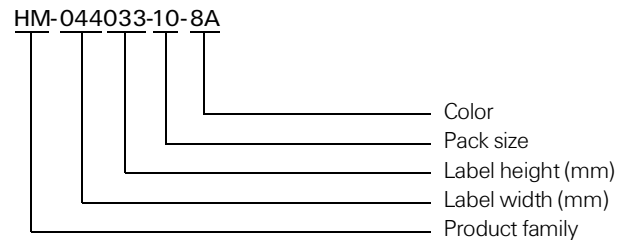

Ordering information

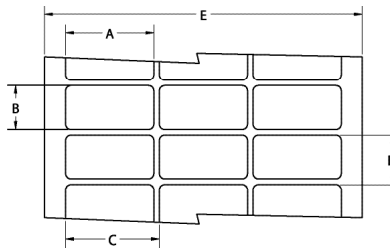

Product dimensions

| Product order code | Package quantity | Labels across | Label width (A) mm inches | Label height (B) mm inches | Horizontal repeat (C) mm inches | Vertical repeat (D) mm inches | Web width (E) mm inches |
|--------------------|------------------|---------------|------------------------------|-------------------------------|------------------------------------|----------------------------------|----------------------------|
| HM-040040-25-8A | 25,000 | 20 | 4.0 0.157 | 4.0 0.157 | 4.0 0.157 | 7.2 0.281 | 86.0 3.380 |
| HM-044033-10-8A | 10,000 | 20 | 4.4 0.170 | 3.3 0.130 | 4.4 0.170 | 9.5 0.375 | 92.4 3.636 |
| HM-064064-25-8A | 25,000 | 12 | 6.4 0.250 | 6.4 0.250 | 6.4 0.250 | 9.5 0.375 | 82.2 3.240 |
| HM-080080-10-8A | 10,000 | 8 | 8.0 0.315 | 8.0 0.315 | 9.9 0.390 | 13.3 0.525 | 83.3 3.280 |
| HM-089047-10-8A | 10,000 | 5 | 8.9 0.350 | 4.7 0.185 | 11.4 0.450 | 7.9 0.313 | 60.6 2.386 |
| HM-095080-25-8A | 25,000 | 5 | 9.5 0.375 | 8.0 0.315 | 12.2 0.480 | 12.7 0.500 | 64.3 2.531 |
| HM-095095-10-8A | 10,000 | 7 | 9.5 0.375 | 9.5 0.375 | 11.1 0.437 | 12.7 0.500 | 82.1 3.230 |
| HM-114040-25-8A | 25,000 | 6 | 11.4 0.450 | 4.0 0.157 | 11.4 0.450 | 7.2 0.281 | 74.6 2.940 |
| HM-127032-10-8A | 10,000 | 5 | 12.7 0.500 | 3.2 0.125 | 19.1 0.750 | 3.2 0.250 | 94.9 3.736 |

(continued)

Product dimensions (continued)

| Product order code | Package quantity | Labels across | Label width (A) | | Label height (B) | | Horizontal repeat (C) | | Vertical repeat (D) | | Web width (E) | |
|--------------------|------------------|---------------|-----------------|---------------|------------------|---------------|-----------------------|---------------|---------------------|---------------|---------------|---------------|
| | | | mm | <i>inches</i> | mm | <i>inches</i> | mm | <i>inches</i> | mm | <i>inches</i> | mm | <i>inches</i> |
| HM-127111-10-8A | 10,000 | 5 | 12.7 | <i>0.500</i> | 11.1 | <i>0.437</i> | 16.8 | <i>0.662</i> | 14.3 | <i>0.563</i> | 86.0 | <i>3.380</i> |
| HM-127127-10-8A | 10,000 | 5 | 12.7 | <i>0.500</i> | 12.7 | <i>0.500</i> | 15.9 | <i>0.625</i> | 15.9 | <i>0.625</i> | 82.6 | <i>3.250</i> |
| HM-165051-25-8A | 25,000 | 4 | 16.5 | <i>0.650</i> | 5.1 | <i>0.200</i> | 17.8 | <i>0.700</i> | 8.3 | <i>0.325</i> | 75.8 | <i>2.990</i> |
| HM-165102-10-8A | 10,000 | 5 | 16.5 | <i>0.650</i> | 10.2 | <i>0.400</i> | 19.1 | <i>0.750</i> | 13.8 | <i>0.545</i> | 99.1 | <i>3.900</i> |
| HM-171171-10-8A | 10,000 | 5 | 17.1 | <i>0.674</i> | 17.1 | <i>0.674</i> | 19.7 | <i>0.774</i> | 20.3 | <i>0.800</i> | 101.8 | <i>4.006</i> |
| HM-178095-10-8A | 10,000 | 4 | 17.8 | <i>0.700</i> | 9.5 | <i>0.375</i> | 19.1 | <i>0.750</i> | 12.7 | <i>0.500</i> | 80.9 | <i>3.190</i> |
| HM-191064-10-8A | 10,000 | 4 | 19.1 | <i>0.750</i> | 6.4 | <i>0.250</i> | 21.6 | <i>0.850</i> | 9.5 | <i>0.375</i> | 89.9 | <i>3.540</i> |
| HM-191114-15-8A | 15,000 | 3 | 19.1 | <i>0.750</i> | 11.4 | <i>0.450</i> | 22.2 | <i>0.875</i> | 14.7 | <i>0.579</i> | 69.5 | <i>2.736</i> |
| HM-191762-5-8A | 5,000 | 3 | 19.1 | <i>0.750</i> | 76.2 | <i>3.000</i> | 21.6 | <i>0.850</i> | 88.9 | <i>3.500</i> | 68.2 | <i>2.686</i> |
| HM-203127-10-8A | 10,000 | 4 | 20.3 | <i>0.800</i> | 12.7 | <i>0.500</i> | 22.9 | <i>0.900</i> | 15.9 | <i>0.625</i> | 94.6 | <i>3.730</i> |
| HM-208086-5-8A | 5,000 | 4 | 20.8 | <i>0.820</i> | 8.6 | <i>0.340</i> | 24.1 | <i>0.950</i> | 12.7 | <i>0.500</i> | 101.6 | <i>4.000</i> |
| HM-222159-15-8A | 15,000 | 2 | 22.2 | <i>0.875</i> | 15.9 | <i>0.625</i> | 24.8 | <i>0.975</i> | 19.1 | <i>0.750</i> | 53.0 | <i>2.086</i> |
| HM-229064-10-8A | 10,000 | 3 | 22.9 | <i>0.900</i> | 6.4 | <i>0.250</i> | 28.6 | <i>1.125</i> | 9.5 | <i>0.375</i> | 86.0 | <i>3.390</i> |
| HM-250381-10-8A | 10,000 | 4 | 24.9 | <i>0.980</i> | 38.1 | <i>1.500</i> | 27.4 | <i>1.080</i> | 47.6 | <i>1.875</i> | 113.5 | <i>4.470</i> |
| HM-254045-10-8A | 10,000 | 3 | 25.4 | <i>1.000</i> | 4.6 | <i>0.180</i> | 31.8 | <i>1.250</i> | 8.5 | <i>0.333</i> | 95.3 | <i>3.750</i> |
| HM-254064-10-8A | 10,000 | 3 | 25.4 | <i>1.000</i> | 6.4 | <i>0.250</i> | 27.9 | <i>1.100</i> | 9.5 | <i>0.375</i> | 87.3 | <i>3.436</i> |
| HM-254097-10-8A | 10,000 | 3 | 25.4 | <i>1.000</i> | 9.7 | <i>0.380</i> | 27.9 | <i>1.100</i> | 12.7 | <i>0.500</i> | 87.4 | <i>3.440</i> |
| HM-254127-10-8A | 10,000 | 3 | 25.4 | <i>1.000</i> | 12.7 | <i>0.500</i> | 27.9 | <i>1.100</i> | 16.9 | <i>0.666</i> | 87.4 | <i>3.440</i> |
| HM-254254-10-8A | 10,000 | 3 | 25.4 | <i>1.000</i> | 25.4 | <i>1.000</i> | 27.9 | <i>1.100</i> | 28.6 | <i>1.125</i> | 87.4 | <i>3.440</i> |
| HM-305047-10-8A | 10,000 | 2 | 30.5 | <i>1.200</i> | 4.7 | <i>0.185</i> | 33.0 | <i>1.300</i> | 7.8 | <i>0.306</i> | 69.5 | <i>2.736</i> |
| HM-318064-10-8A | 10,000 | 1 | 31.8 | <i>1.250</i> | 6.4 | <i>0.250</i> | N/A | N/A | 9.5 | <i>0.375</i> | 37.9 | <i>1.490</i> |
| HM-318097-10-8A | 10,000 | 1 | 31.8 | <i>1.250</i> | 9.7 | <i>0.380</i> | N/A | N/A | 12.7 | <i>0.500</i> | 37.8 | <i>1.488</i> |
| HM-381020-10-8A | 10,000 | 1 | 38.1 | <i>1.500</i> | 2.0 | <i>0.080</i> | N/A | N/A | 10.7 | <i>0.423</i> | 44.1 | <i>1.740</i> |
| HM-381064-10-8A | 10,000 | 1 | 38.1 | <i>1.500</i> | 6.4 | <i>0.250</i> | N/A | N/A | 9.5 | <i>0.375</i> | 44.5 | <i>1.750</i> |
| HM-381127-5-8A | 5,000 | 2 | 38.1 | <i>1.500</i> | 12.7 | <i>0.500</i> | 44.2 | <i>1.738</i> | 15.9 | <i>0.625</i> | 88.2 | <i>3.472</i> |
| HM-381191-5-8A | 5,000 | 2 | 38.1 | <i>1.500</i> | 19.1 | <i>0.750</i> | 43.2 | <i>1.700</i> | 22.2 | <i>0.875</i> | 87.6 | <i>3.450</i> |
| HM-381381-2.5-8A | 2,500 | 2 | 38.1 | <i>1.500</i> | 38.1 | <i>1.500</i> | 44.5 | <i>1.750</i> | 40.8 | <i>1.607</i> | 88.9 | <i>3.500</i> |
| HM-381635-5-8A | 5,000 | 2 | 38.1 | <i>1.500</i> | 63.5 | <i>2.500</i> | 40.6 | <i>1.600</i> | 66.7 | <i>2.625</i> | 84.7 | <i>3.336</i> |
| HM-406254-1.5-8A | 1,500 | 2 | 40.6 | <i>1.600</i> | 25.4 | <i>1.000</i> | 55.9 | <i>2.200</i> | 38.1 | <i>1.500</i> | 102.9 | <i>4.050</i> |
| HM-445064-10-8A | 10,000 | 1 | 44.5 | <i>1.750</i> | 6.4 | <i>0.250</i> | N/A | N/A | 9.5 | <i>0.375</i> | 50.4 | <i>1.986</i> |
| HM-445102-5-8A | 5,000 | 1 | 44.5 | <i>1.750</i> | 10.2 | <i>0.400</i> | N/A | N/A | 12.7 | <i>0.500</i> | 50.4 | <i>1.986</i> |
| HM-445445-2-8A | 2,000 | 1 | 44.5 | <i>1.750</i> | 44.5 | <i>1.750</i> | N/A | N/A | 47.6 | <i>1.875</i> | 50.4 | <i>1.986</i> |
| HM-478175-5-8A | 5,000 | 1 | 47.8 | <i>1.880</i> | 17.5 | <i>0.690</i> | N/A | N/A | 24.4 | <i>0.962</i> | 66.0 | <i>2.600</i> |
| HM-508064-10-8A | 10,000 | 1 | 50.8 | <i>2.000</i> | 6.4 | <i>0.250</i> | N/A | N/A | 9.5 | <i>0.375</i> | 56.9 | <i>2.240</i> |
| HM-508095-5-8A | 5,000 | 1 | 50.8 | <i>2.000</i> | 9.5 | <i>0.375</i> | N/A | N/A | 12.7 | <i>0.500</i> | 57.2 | <i>2.250</i> |
| HM-508127-10-8A | 10,000 | 1 | 50.8 | <i>2.000</i> | 12.7 | <i>0.500</i> | N/A | N/A | 15.9 | <i>0.625</i> | 56.9 | <i>2.240</i> |
| HM-508254-5-8A | 5,000 | 1 | 50.8 | <i>2.000</i> | 25.4 | <i>1.000</i> | N/A | N/A | 28.6 | <i>1.125</i> | 57.2 | <i>2.250</i> |
| HM-508318-2.5-8A | 2,500 | 1 | 50.8 | <i>2.000</i> | 31.8 | <i>1.250</i> | N/A | N/A | 34.9 | <i>1.375</i> | 56.9 | <i>2.240</i> |
| HM-508508-3-8A | 3,000 | 1 | 50.8 | <i>2.000</i> | 50.8 | <i>2.000</i> | N/A | N/A | 54.6 | <i>2.150</i> | 54.0 | <i>2.130</i> |
| HM-523841-1.5-8A | 1,500 | 1 | 52.3 | <i>2.060</i> | 84.1 | <i>3.310</i> | N/A | N/A | 88.9 | <i>3.500</i> | 58.2 | <i>2.290</i> |
| HM-610419-2.5-8A | 2,500 | 1 | 61.0 | <i>2.400</i> | 41.9 | <i>1.650</i> | N/A | N/A | 45.5 | <i>1.792</i> | 67.3 | <i>2.650</i> |
| HM-699191-5-8A | 5,000 | 1 | 69.9 | <i>2.750</i> | 19.1 | <i>0.750</i> | N/A | N/A | 23.3 | <i>0.917</i> | 76.2 | <i>3.000</i> |
| HM-699254-5-8A | 5,000 | 1 | 69.9 | <i>2.750</i> | 25.4 | <i>1.000</i> | N/A | N/A | 28.6 | <i>1.125</i> | 76.2 | <i>3.000</i> |
| HM-762381-2.5-8A | 2,500 | 1 | 76.2 | <i>3.000</i> | 38.1 | <i>1.500</i> | N/A | N/A | 41.3 | <i>1.625</i> | 82.3 | <i>3.240</i> |
| HM-762508-2.5-8A | 2,500 | 1 | 76.2 | <i>3.000</i> | 50.8 | <i>2.000</i> | N/A | N/A | 54.0 | <i>2.125</i> | 82.6 | <i>3.240</i> |
| HM-762127-1-8A | 1,000 | 1 | 76.2 | <i>3.000</i> | 127.0 | <i>5.000</i> | N/A | N/A | 129.5 | <i>5.100</i> | 79.4 | <i>3.130</i> |
| HM-101508-2.5-8A | 2,500 | 1 | 101.6 | <i>4.000</i> | 50.8 | <i>2.000</i> | N/A | N/A | 54.6 | <i>2.150</i> | 104.1 | <i>4.100</i> |
| HM-101635-2.5-8A | 2,500 | 1 | 101.6 | <i>4.000</i> | 63.5 | <i>2.500</i> | N/A | N/A | 66.7 | <i>2.625</i> | 107.7 | <i>4.240</i> |
| HM-101762-1.8-8A | 1,800 | 1 | 101.6 | <i>4.000</i> | 76.2 | <i>3.000</i> | N/A | N/A | 79.4 | <i>3.125</i> | 104.1 | <i>4.100</i> |
| HM-101101-1.3-8A | 1,300 | 1 | 101.6 | <i>4.000</i> | 101.6 | <i>4.000</i> | N/A | N/A | 104.8 | <i>4.125</i> | 104.1 | <i>4.100</i> |
| HM-101165-0.85-8A | 850 | 1 | 101.6 | <i>4.000</i> | 165.1 | <i>6.500</i> | N/A | N/A | 168.3 | <i>6.680</i> | 104.9 | <i>4.130</i> |

MP Metalized polyester labels

Tyco MP is a thermal transfer printable metalized polyester film with a permanent acrylic adhesive, designed for rating plates and other applications that require a metal look, such as nameplates, equipment labels, detailed product information labels and serial number plates. MP is UL Listed and CSA Certified. Print performance and durability are guaranteed when used with Tyco's RHD series ribbon.

Features and benefits

- Thermal transfer printable.
- Metalized appearance.
- Ideal for rating plate applications.
- Several die-cut sizes available.
- UL Listed and CSA Certified.



| | | |
|----------------------------|--|-----------------|
| Adhesive | Permanent acrylic | |
| Service temperature | -40°C to +150°F | -40°F to +302°F |
| Recommended printer | T308S* | |
| Recommended ribbon | 1330-0607-10* | |
| | <i>*Alternative printers and ribbons are available for special applications. Contact Tyco Electronics Identification for more information.</i> | |

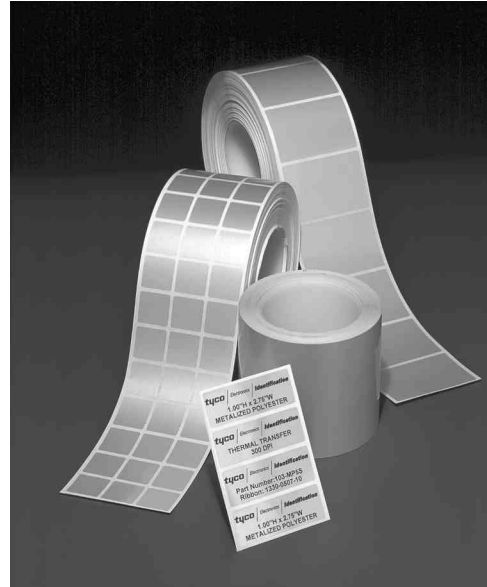

Part numbering system

MP-044033-10-8A

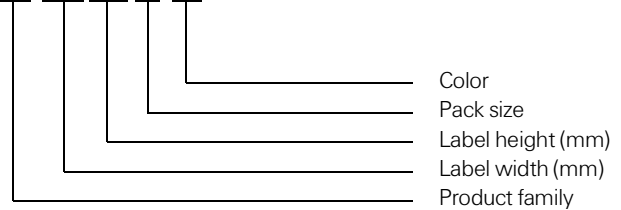

Ordering information



Product dimensions

| Product order code | Package quantity | Labels across | Label width (A) | | Label height (B) | | Horizontal repeat (C) | | Vertical repeat (D) | | Web width (E) | |
|--------------------|------------------|---------------|-----------------|--------|------------------|--------|-----------------------|--------|---------------------|--------|---------------|--------|
| | | | mm | inches | mm | inches | mm | inches | mm | inches | mm | inches |
| MP-040040-25-8A | 25,000 | 20 | 4.0 | 0.157 | 4.0 | 0.160 | 4.0 | 0.157 | 7.2 | 0.281 | 86.0 | 3.380 |
| MP-044033-10-8A | 10,000 | 20 | 4.4 | 0.170 | 3.3 | 0.130 | 4.4 | 0.170 | 9.5 | 0.375 | 92.4 | 3.636 |
| MP-064064-25-8A | 25,000 | 12 | 6.4 | 0.250 | 6.4 | 0.250 | 6.4 | 0.250 | 9.5 | 0.375 | 82.2 | 3.240 |
| MP-080080-10-8A | 10,000 | 8 | 8.0 | 0.315 | 8.0 | 0.315 | 9.9 | 0.390 | 13.3 | 0.525 | 83.3 | 3.280 |
| MP-089047-10-8A | 10,000 | 5 | 8.9 | 0.350 | 4.7 | 0.185 | 11.4 | 0.450 | 7.9 | 0.313 | 60.6 | 2.386 |
| MP-095080-25-8A | 25,000 | 5 | 9.5 | 0.375 | 8.0 | 0.315 | 12.2 | 0.475 | 12.7 | 0.500 | 64.3 | 2.531 |
| MP-095095-10-8A | 10,000 | 7 | 9.5 | 0.375 | 9.5 | 0.375 | 11.1 | 0.437 | 12.7 | 0.500 | 82.1 | 3.230 |
| MP-114040-25-8A | 25,000 | 6 | 11.4 | 0.450 | 4.0 | 0.157 | 11.4 | 0.450 | 7.2 | 0.281 | 74.6 | 2.940 |
| MP-127032-10-8A | 10,000 | 5 | 12.7 | 0.500 | 3.2 | 0.125 | 19.1 | 0.750 | 3.2 | 0.250 | 94.9 | 3.736 |

(continued)

Product dimensions (continued)

| Product order code | Package quantity | Labels across | Label width (A) | | Label height (B) | | Horizontal repeat (C) | | Vertical repeat (D) | | Web width (E) | |
|--------------------|------------------|---------------|-----------------|---------------|------------------|---------------|-----------------------|---------------|---------------------|---------------|---------------|---------------|
| | | | mm | <i>inches</i> | mm | <i>inches</i> | mm | <i>inches</i> | mm | <i>inches</i> | mm | <i>inches</i> |
| MP-127111-10-8A | 10,000 | 5 | 12.7 | <i>0.500</i> | 11.1 | <i>0.437</i> | 16.8 | <i>0.662</i> | 14.3 | <i>0.563</i> | 86.0 | <i>3.380</i> |
| MP-127127-10-8A | 10,000 | 5 | 12.7 | <i>0.500</i> | 12.7 | <i>0.500</i> | 15.9 | <i>0.625</i> | 15.9 | <i>0.625</i> | 82.6 | <i>3.250</i> |
| MP-165051-25-8A | 25,000 | 4 | 16.5 | <i>0.650</i> | 5.1 | <i>0.200</i> | 17.8 | <i>0.700</i> | 8.3 | <i>0.325</i> | 75.8 | <i>2.990</i> |
| MP-165102-10-8A | 10,000 | 5 | 16.5 | <i>0.650</i> | 10.2 | <i>0.400</i> | 19.1 | <i>0.750</i> | 13.8 | <i>0.545</i> | 99.1 | <i>3.900</i> |
| MP-171171-10-8A | 10,000 | 5 | 17.1 | <i>0.674</i> | 17.1 | <i>0.674</i> | 19.7 | <i>0.774</i> | 20.3 | <i>0.800</i> | 101.8 | <i>4.006</i> |
| MP-178095-10-8A | 10,000 | 4 | 17.8 | <i>0.700</i> | 9.5 | <i>0.375</i> | 19.1 | <i>0.750</i> | 12.7 | <i>0.500</i> | 80.9 | <i>3.190</i> |
| MP-191064-10-8A | 10,000 | 4 | 19.1 | <i>0.750</i> | 6.4 | <i>0.250</i> | 21.6 | <i>0.850</i> | 9.5 | <i>0.375</i> | 89.9 | <i>3.540</i> |
| MP-191114-15-8A | 15,000 | 3 | 19.1 | <i>0.750</i> | 11.4 | <i>0.450</i> | 22.2 | <i>0.875</i> | 14.7 | <i>0.579</i> | 69.5 | <i>2.736</i> |
| MP-191762-5-8A | 5,000 | 3 | 19.1 | <i>0.750</i> | 76.2 | <i>3.000</i> | 21.6 | <i>0.850</i> | 88.9 | <i>3.500</i> | 68.2 | <i>2.686</i> |
| MP-203127-10-8A | 10,000 | 4 | 20.3 | <i>0.800</i> | 12.7 | <i>0.500</i> | 22.9 | <i>0.900</i> | 15.9 | <i>0.625</i> | 94.6 | <i>3.730</i> |
| MP-208086-5-8A | 5,000 | 4 | 20.8 | <i>0.820</i> | 8.6 | <i>0.340</i> | 24.1 | <i>0.950</i> | 12.7 | <i>0.500</i> | 101.6 | <i>4.000</i> |
| MP-222159-15-8A | 15,000 | 2 | 22.2 | <i>0.875</i> | 15.9 | <i>0.625</i> | 24.8 | <i>0.975</i> | 19.1 | <i>0.750</i> | 53.0 | <i>2.086</i> |
| MP-229064-10-8A | 10,000 | 3 | 22.9 | <i>0.900</i> | 6.4 | <i>0.250</i> | 28.6 | <i>1.125</i> | 9.5 | <i>0.375</i> | 86.0 | <i>3.390</i> |
| MP-250381-10-8A | 10,000 | 4 | 24.9 | <i>0.980</i> | 38.1 | <i>1.500</i> | 27.4 | <i>1.080</i> | 47.6 | <i>1.875</i> | 113.5 | <i>4.470</i> |
| MP-254045-10-8A | 10,000 | 3 | 25.4 | <i>1.000</i> | 4.6 | <i>0.180</i> | 31.8 | <i>1.250</i> | 8.5 | <i>0.333</i> | 95.3 | <i>3.750</i> |
| MP-254064-10-8A | 10,000 | 3 | 25.4 | <i>1.000</i> | 6.4 | <i>0.250</i> | 27.9 | <i>1.100</i> | 9.5 | <i>0.375</i> | 87.3 | <i>3.436</i> |
| MP-254097-10-8A | 10,000 | 3 | 25.4 | <i>1.000</i> | 9.7 | <i>0.380</i> | 27.9 | <i>1.100</i> | 12.7 | <i>0.500</i> | 87.4 | <i>3.440</i> |
| MP-254127-10-8A | 10,000 | 3 | 25.4 | <i>1.000</i> | 12.7 | <i>0.500</i> | 27.9 | <i>1.100</i> | 16.9 | <i>0.666</i> | 87.4 | <i>3.440</i> |
| MP-254254-10-8A | 10,000 | 3 | 25.4 | <i>1.000</i> | 25.4 | <i>1.000</i> | 27.9 | <i>1.100</i> | 28.6 | <i>1.125</i> | 87.4 | <i>3.440</i> |
| MP-305047-10-8A | 10,000 | 2 | 30.5 | <i>1.200</i> | 4.7 | <i>0.185</i> | 33.0 | <i>1.300</i> | 7.8 | <i>0.306</i> | 69.5 | <i>2.736</i> |
| MP-318064-10-8A | 10,000 | 1 | 31.8 | <i>1.250</i> | 6.4 | <i>0.250</i> | N/A | N/A | 9.5 | <i>0.375</i> | 37.9 | <i>1.490</i> |
| MP-318097-10-8A | 10,000 | 1 | 31.8 | <i>1.250</i> | 9.7 | <i>0.380</i> | N/A | N/A | 12.7 | <i>0.500</i> | 37.8 | <i>1.488</i> |
| MP-381020-10-8A | 10,000 | 1 | 38.1 | <i>1.500</i> | 2.0 | <i>0.080</i> | N/A | N/A | 10.7 | <i>0.423</i> | 44.1 | <i>1.740</i> |
| MP-381064-10-8A | 10,000 | 1 | 38.1 | <i>1.500</i> | 6.4 | <i>0.250</i> | N/A | N/A | 9.5 | <i>0.375</i> | 44.5 | <i>1.750</i> |
| MP-381127-5-8A | 5,000 | 2 | 38.1 | <i>1.500</i> | 12.7 | <i>0.500</i> | 44.2 | <i>1.738</i> | 15.9 | <i>0.625</i> | 88.2 | <i>3.472</i> |
| MP-381191-5-8A | 5,000 | 2 | 38.1 | <i>1.500</i> | 19.1 | <i>0.750</i> | 43.2 | <i>1.700</i> | 22.2 | <i>0.875</i> | 87.6 | <i>3.450</i> |
| MP-381381-2.5-8A | 2,500 | 2 | 38.1 | <i>1.500</i> | 38.1 | <i>1.500</i> | 44.5 | <i>1.750</i> | 40.8 | <i>1.607</i> | 88.9 | <i>3.500</i> |
| MP-381635-5-8A | 5,000 | 2 | 38.1 | <i>1.500</i> | 63.5 | <i>2.500</i> | 40.6 | <i>1.600</i> | 66.7 | <i>2.625</i> | 84.7 | <i>3.336</i> |
| MP-406254-1.5-8A | 1,500 | 2 | 40.6 | <i>1.600</i> | 25.4 | <i>1.000</i> | 55.9 | <i>2.200</i> | 38.1 | <i>1.500</i> | 102.9 | <i>4.050</i> |
| MP-445064-10-8A | 10,000 | 1 | 44.5 | <i>1.750</i> | 6.4 | <i>0.250</i> | N/A | N/A | 9.5 | <i>0.375</i> | 50.4 | <i>1.986</i> |
| MP-445102-5-8A | 5,000 | 1 | 44.5 | <i>1.750</i> | 10.2 | <i>0.400</i> | N/A | N/A | 12.7 | <i>0.500</i> | 50.4 | <i>1.986</i> |
| MP-445445-2-8A | 2,000 | 1 | 44.5 | <i>1.750</i> | 44.5 | <i>1.750</i> | N/A | N/A | 47.6 | <i>1.875</i> | 50.4 | <i>1.986</i> |
| MP-478175-5-8A | 5,000 | 1 | 47.8 | <i>1.875</i> | 17.5 | <i>0.690</i> | N/A | N/A | 24.4 | <i>0.962</i> | 66.0 | <i>2.600</i> |
| MP-508064-10-8A | 10,000 | 1 | 50.8 | <i>2.000</i> | 6.4 | <i>0.250</i> | N/A | N/A | 9.5 | <i>0.375</i> | 56.9 | <i>2.240</i> |
| MP-508095-5-8A | 5,000 | 1 | 50.8 | <i>2.000</i> | 9.5 | <i>0.375</i> | N/A | N/A | 12.7 | <i>0.500</i> | 57.2 | <i>2.250</i> |
| MP-508127-10-8A | 10,000 | 1 | 50.8 | <i>2.000</i> | 12.7 | <i>0.500</i> | N/A | N/A | 15.9 | <i>0.625</i> | 56.9 | <i>2.240</i> |
| MP-508254-5-8A | 5,000 | 1 | 50.8 | <i>2.000</i> | 25.4 | <i>1.000</i> | N/A | N/A | 28.6 | <i>1.125</i> | 57.2 | <i>2.250</i> |
| MP-508318-2.5-8A | 2,500 | 1 | 50.8 | <i>2.000</i> | 31.8 | <i>1.250</i> | N/A | N/A | 34.9 | <i>1.375</i> | 56.9 | <i>2.240</i> |
| MP-508508-3-8A | 3,000 | 1 | 50.8 | <i>2.000</i> | 50.8 | <i>2.000</i> | N/A | N/A | 54.6 | <i>2.150</i> | 54.0 | <i>2.130</i> |
| MP-523841-1.5-8A | 1,500 | 1 | 52.3 | <i>2.060</i> | 84.1 | <i>3.310</i> | N/A | N/A | 88.9 | <i>3.500</i> | 58.2 | <i>2.290</i> |
| MP-610419-2.5-8A | 2,500 | 1 | 61.0 | <i>2.400</i> | 41.9 | <i>1.650</i> | N/A | N/A | 45.5 | <i>1.792</i> | 67.3 | <i>2.650</i> |
| MP-699191-5-8A | 5,000 | 1 | 69.9 | <i>2.750</i> | 19.1 | <i>0.750</i> | N/A | N/A | 23.3 | <i>0.917</i> | 76.2 | <i>3.000</i> |
| MP-699254-5-8A | 5,000 | 1 | 69.9 | <i>2.750</i> | 25.4 | <i>1.000</i> | N/A | N/A | 28.6 | <i>1.125</i> | 76.2 | <i>3.000</i> |
| MP-762381-2.5-8A | 2,500 | 1 | 76.2 | <i>3.000</i> | 38.1 | <i>1.500</i> | N/A | N/A | 41.3 | <i>1.625</i> | 82.3 | <i>3.240</i> |
| MP-762508-2.5-8A | 2,500 | 1 | 76.2 | <i>3.000</i> | 50.8 | <i>2.000</i> | N/A | N/A | 54.0 | <i>2.125</i> | 82.6 | <i>3.240</i> |
| MP-762127-1-8A | 1,000 | 1 | 76.2 | <i>3.000</i> | 127.0 | <i>5.000</i> | N/A | N/A | 129.5 | <i>5.100</i> | 79.4 | <i>3.130</i> |
| MP-101508-2.5-8A | 2,500 | 1 | 101.6 | <i>4.000</i> | 50.8 | <i>2.000</i> | N/A | N/A | 54.6 | <i>2.150</i> | 104.1 | <i>4.100</i> |
| MP-101635-2.5-8A | 2,500 | 1 | 101.6 | <i>4.000</i> | 63.5 | <i>2.500</i> | N/A | N/A | 66.7 | <i>2.625</i> | 107.7 | <i>4.240</i> |
| MP-101762-1.8-8A | 1,800 | 1 | 101.6 | <i>4.000</i> | 76.2 | <i>3.000</i> | N/A | N/A | 79.4 | <i>3.125</i> | 104.1 | <i>4.100</i> |
| MP-101101-1.3-8A | 1,300 | 1 | 101.6 | <i>4.000</i> | 101.6 | <i>4.000</i> | N/A | N/A | 104.8 | <i>4.125</i> | 104.1 | <i>4.100</i> |
| MP-101165-0.85-8A | 850 | 1 | 101.6 | <i>4.000</i> | 165.1 | <i>6.500</i> | N/A | N/A | 168.3 | <i>6.680</i> | 104.9 | <i>4.130</i> |



Electronics

Thermal Transfer

MV Tamper-evident metalized polyester labels

Tyco MV is a thermal transfer printable metalized polyester film with a permanent acrylic adhesive, designed with a tamper-evident feature which leaves a void footprint when removed. It is ideal for applications such as rating plate and serial number labels that require protection against removal. For guaranteed print performance and durability, use with Tyco's RHD series ribbon.

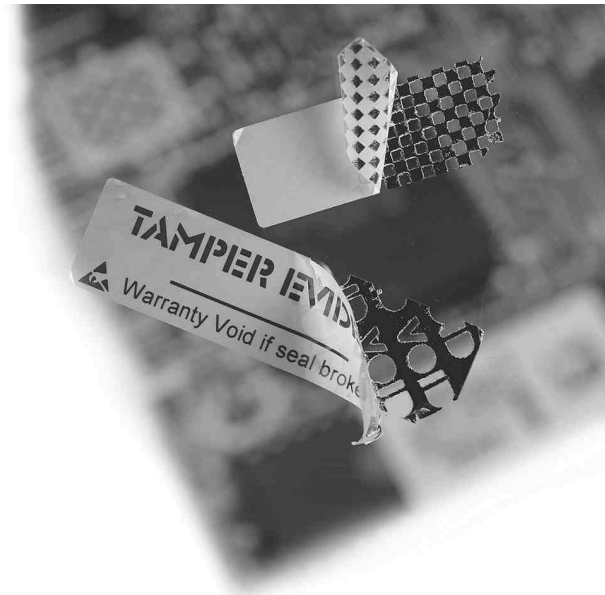

Features and benefits

- Thermal transfer printable.
- Metalized appearance.
- Ideal for security applications.
- UL Recognized.



| | |
|--|------------------------------------|
| Adhesive | Permanent acrylic |
| Service temperature | -40°C to +150°C -40°F to +302°F |
| Recommended printer | T308S* |
| Recommended ribbon | 1330-0607-10* |
| <small>*Alternative printers and ribbons are available for special applications. Contact Tyco Electronics Identification for more information.</small> | |

Part numbering system

MV-044033-10-8A

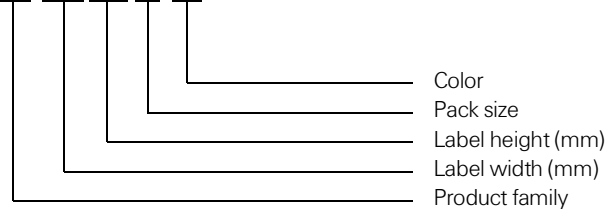

Ordering information

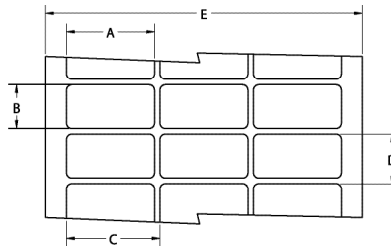

Product dimensions

| Product order code | Package quantity | Labels across | Label width (A) | | Label height (B) | | Horizontal repeat (C) | | Vertical repeat (D) | | Web width (E) | |
|--------------------|------------------|---------------|-----------------|--------|------------------|--------|-----------------------|--------|---------------------|--------|---------------|--------|
| | | | mm | inches | mm | inches | mm | inches | mm | inches | mm | inches |
| MV-040040-25-8A | 25,000 | 20 | 4.0 | 0.157 | 4.0 | 0.157 | 4.0 | 0.157 | 7.2 | 0.281 | 86.0 | 3.380 |
| MV-044033-10-8A | 10,000 | 20 | 4.4 | 0.170 | 3.3 | 0.130 | 4.4 | 0.170 | 9.5 | 0.375 | 92.4 | 3.636 |
| MV-064064-25-8A | 25,000 | 12 | 6.4 | 0.250 | 6.4 | 0.250 | 6.4 | 0.250 | 9.5 | 0.375 | 82.2 | 3.240 |
| MV-080080-10-8A | 10,000 | 8 | 8.0 | 0.315 | 8.0 | 0.315 | 9.9 | 0.390 | 13.3 | 0.525 | 83.3 | 3.280 |
| MV-089047-10-8A | 10,000 | 5 | 8.9 | 0.350 | 4.7 | 0.185 | 11.4 | 0.450 | 7.9 | 0.313 | 60.6 | 2.386 |
| MV-095080-25-8A | 25,000 | 5 | 9.5 | 0.375 | 8.0 | 0.315 | 12.2 | 0.480 | 12.7 | 0.500 | 64.3 | 2.531 |
| MV-095095-10-8A | 10,000 | 7 | 9.5 | 0.375 | 9.5 | 0.375 | 11.1 | 0.437 | 12.7 | 0.500 | 82.1 | 3.230 |
| MV-114040-25-8A | 25,000 | 6 | 11.4 | 0.450 | 4.0 | 0.157 | 11.4 | 0.450 | 7.2 | 0.281 | 74.6 | 2.940 |
| MV-127032-10-8A | 10,000 | 5 | 12.7 | 0.500 | 3.2 | 0.125 | 19.1 | 0.750 | 3.2 | 0.250 | 94.9 | 3.736 |

(continued)

MV Tamper-evident metalized polyester labels (Cont'd)

Product dimensions (continued)

| Product order code | Package quantity | Labels across | Label width (A) | | Label height (B) | | Horizontal repeat (C) | | Vertical repeat (D) | | Web width (E) | |
|--------------------|------------------|---------------|-----------------|---------------|------------------|---------------|-----------------------|---------------|---------------------|---------------|---------------|---------------|
| | | | mm | <i>inches</i> | mm | <i>inches</i> | mm | <i>inches</i> | mm | <i>inches</i> | mm | <i>inches</i> |
| MV-127111-10-8A | 10,000 | 5 | 12.7 | <i>0.500</i> | 11.1 | <i>0.437</i> | 16.8 | <i>0.662</i> | 14.3 | <i>0.563</i> | 86.0 | <i>3.380</i> |
| MV-127127-10-8A | 10,000 | 5 | 12.7 | <i>0.500</i> | 12.7 | <i>0.500</i> | 15.9 | <i>0.625</i> | 15.9 | <i>0.625</i> | 82.6 | <i>3.250</i> |
| MV-165051-25-8A | 25,000 | 4 | 16.5 | <i>0.650</i> | 5.1 | <i>0.200</i> | 17.8 | <i>0.700</i> | 8.3 | <i>0.325</i> | 75.8 | <i>2.990</i> |
| MV-165102-10-8A | 10,000 | 5 | 16.5 | <i>0.650</i> | 10.2 | <i>0.400</i> | 19.1 | <i>0.750</i> | 13.8 | <i>0.545</i> | 99.1 | <i>3.900</i> |
| MV-171171-10-8A | 10,000 | 5 | 17.1 | <i>0.674</i> | 17.1 | <i>0.674</i> | 19.7 | <i>0.774</i> | 20.3 | <i>0.800</i> | 101.8 | <i>4.006</i> |
| MV-178095-10-8A | 10,000 | 4 | 17.8 | <i>0.700</i> | 9.5 | <i>0.375</i> | 19.1 | <i>0.750</i> | 12.7 | <i>0.500</i> | 80.9 | <i>3.190</i> |
| MV-191064-10-8A | 10,000 | 4 | 19.1 | <i>0.750</i> | 6.4 | <i>0.250</i> | 21.6 | <i>0.850</i> | 9.5 | <i>0.375</i> | 89.9 | <i>3.540</i> |
| MV-191114-15-8A | 15,000 | 3 | 19.1 | <i>0.750</i> | 11.4 | <i>0.450</i> | 22.2 | <i>0.875</i> | 14.7 | <i>0.579</i> | 69.5 | <i>2.736</i> |
| MV-191762-5-8A | 5,000 | 3 | 19.1 | <i>0.750</i> | 76.2 | <i>3.000</i> | 21.6 | <i>0.850</i> | 88.9 | <i>3.500</i> | 68.2 | <i>2.686</i> |
| MV-203127-10-8A | 10,000 | 4 | 20.3 | <i>0.800</i> | 12.7 | <i>0.500</i> | 22.9 | <i>0.900</i> | 15.9 | <i>0.625</i> | 94.6 | <i>3.730</i> |
| MV-208086-5-8A | 5,000 | 4 | 20.8 | <i>0.820</i> | 8.6 | <i>0.340</i> | 24.1 | <i>0.950</i> | 12.7 | <i>0.500</i> | 101.6 | <i>4.000</i> |
| MV-222159-15-8A | 15,000 | 2 | 22.2 | <i>0.875</i> | 15.9 | <i>0.625</i> | 24.8 | <i>0.975</i> | 19.1 | <i>0.750</i> | 53.0 | <i>2.086</i> |
| MV-229064-10-8A | 10,000 | 3 | 22.9 | <i>0.900</i> | 6.4 | <i>0.250</i> | 28.6 | <i>1.125</i> | 9.5 | <i>0.375</i> | 86.0 | <i>3.390</i> |
| MV-250381-10-8A | 10,000 | 4 | 24.9 | <i>0.980</i> | 38.1 | <i>1.500</i> | 27.4 | <i>1.080</i> | 47.6 | <i>1.875</i> | 113.5 | <i>4.470</i> |
| MV-254045-10-8A | 10,000 | 3 | 25.4 | <i>1.000</i> | 4.6 | <i>0.180</i> | 31.8 | <i>1.250</i> | 8.5 | <i>0.333</i> | 95.3 | <i>3.750</i> |
| MV-254064-10-8A | 10,000 | 3 | 25.4 | <i>1.000</i> | 6.4 | <i>0.250</i> | 27.9 | <i>1.100</i> | 9.5 | <i>0.375</i> | 87.3 | <i>3.436</i> |
| MV-254097-10-8A | 10,000 | 3 | 25.4 | <i>1.000</i> | 9.7 | <i>0.380</i> | 27.9 | <i>1.100</i> | 12.7 | <i>0.500</i> | 87.4 | <i>3.440</i> |
| MV-254127-10-8A | 10,000 | 3 | 25.4 | <i>1.000</i> | 12.7 | <i>0.500</i> | 27.9 | <i>1.100</i> | 16.9 | <i>0.666</i> | 87.4 | <i>3.440</i> |
| MV-254254-10-8A | 10,000 | 3 | 25.4 | <i>1.000</i> | 25.4 | <i>1.000</i> | 27.9 | <i>1.100</i> | 28.6 | <i>1.125</i> | 87.4 | <i>3.440</i> |
| MV-305047-10-8A | 10,000 | 2 | 30.5 | <i>1.200</i> | 4.7 | <i>0.185</i> | 33.0 | <i>1.300</i> | 7.8 | <i>0.306</i> | 69.5 | <i>2.736</i> |
| MV-318064-10-8A | 10,000 | 1 | 31.8 | <i>1.250</i> | 6.4 | <i>0.250</i> | N/A | N/A | 9.5 | <i>0.375</i> | 37.9 | <i>1.490</i> |
| MV-318097-10-8A | 10,000 | 1 | 31.8 | <i>1.250</i> | 9.7 | <i>0.380</i> | N/A | N/A | 12.7 | <i>0.500</i> | 37.8 | <i>1.486</i> |
| MV-381020-10-8A | 10,000 | 1 | 38.1 | <i>1.500</i> | 2.0 | <i>0.080</i> | N/A | N/A | 10.7 | <i>0.423</i> | 44.1 | <i>1.740</i> |
| MV-381064-10-8A | 10,000 | 1 | 38.1 | <i>1.500</i> | 6.4 | <i>0.250</i> | N/A | N/A | 9.5 | <i>0.375</i> | 44.5 | <i>1.750</i> |
| MV-381127-5-8A | 5,000 | 2 | 38.1 | <i>1.500</i> | 12.7 | <i>0.500</i> | 44.2 | <i>1.738</i> | 15.9 | <i>0.625</i> | 88.2 | <i>3.472</i> |
| MV-381191-5-8A | 5,000 | 2 | 38.1 | <i>1.500</i> | 19.1 | <i>0.750</i> | 43.2 | <i>1.700</i> | 22.2 | <i>0.875</i> | 87.6 | <i>3.450</i> |
| MV-381381-2.5-8A | 2,500 | 2 | 38.1 | <i>1.500</i> | 38.1 | <i>1.500</i> | 44.5 | <i>1.750</i> | 40.8 | <i>1.607</i> | 88.9 | <i>3.500</i> |
| MV-381635-5-8A | 5,000 | 2 | 38.1 | <i>1.500</i> | 63.5 | <i>2.500</i> | 40.6 | <i>1.600</i> | 66.7 | <i>2.625</i> | 84.7 | <i>3.336</i> |
| MV-406254-1.5-8A | 1,500 | 2 | 40.6 | <i>1.600</i> | 25.4 | <i>1.000</i> | 55.9 | <i>2.200</i> | 38.1 | <i>1.500</i> | 102.9 | <i>4.050</i> |
| MV-445064-10-8A | 10,000 | 1 | 44.5 | <i>1.750</i> | 6.4 | <i>0.250</i> | N/A | N/A | 9.5 | <i>0.375</i> | 50.4 | <i>1.986</i> |
| MV-445102-5-8A | 5,000 | 1 | 44.5 | <i>1.750</i> | 10.2 | <i>0.400</i> | N/A | N/A | 12.7 | <i>0.500</i> | 50.4 | <i>1.986</i> |
| MV-445445-2-8A | 2,000 | 1 | 44.5 | <i>1.750</i> | 44.5 | <i>1.750</i> | N/A | N/A | 47.6 | <i>1.875</i> | 50.4 | <i>1.986</i> |
| MV-478175-5-8A | 5,000 | 1 | 47.8 | <i>1.880</i> | 17.5 | <i>0.690</i> | N/A | N/A | 24.4 | <i>0.962</i> | 66.0 | <i>2.600</i> |
| MV-508064-10-8A | 10,000 | 1 | 50.8 | <i>2.000</i> | 6.4 | <i>0.250</i> | N/A | N/A | 9.5 | <i>0.375</i> | 56.9 | <i>2.240</i> |
| MV-508095-5-8A | 5,000 | 1 | 50.8 | <i>2.000</i> | 9.5 | <i>0.375</i> | N/A | N/A | 12.7 | <i>0.500</i> | 57.2 | <i>2.250</i> |
| MV-508127-10-8A | 10,000 | 1 | 50.8 | <i>2.000</i> | 12.7 | <i>0.500</i> | N/A | N/A | 15.9 | <i>0.625</i> | 56.9 | <i>2.240</i> |
| MV-508254-5-8A | 5,000 | 1 | 50.8 | <i>2.000</i> | 25.4 | <i>1.000</i> | N/A | N/A | 28.6 | <i>1.125</i> | 57.2 | <i>2.250</i> |
| MV-508318-2.5-8A | 2,500 | 1 | 50.8 | <i>2.000</i> | 31.8 | <i>1.250</i> | N/A | N/A | 34.9 | <i>1.375</i> | 56.9 | <i>2.240</i> |
| MV-508508-3-8A | 3,000 | 1 | 50.8 | <i>2.000</i> | 50.8 | <i>2.000</i> | N/A | N/A | 54.6 | <i>2.150</i> | 54.0 | <i>2.130</i> |
| MV-523841-1.5-8A | 1,500 | 1 | 52.3 | <i>2.060</i> | 84.1 | <i>3.310</i> | N/A | N/A | 88.9 | <i>3.500</i> | 58.2 | <i>2.290</i> |
| MV-610419-2.5-8A | 2,500 | 1 | 61.0 | <i>2.400</i> | 41.9 | <i>1.650</i> | N/A | N/A | 45.5 | <i>1.792</i> | 67.3 | <i>2.650</i> |
| MV-699191-5-8A | 5,000 | 1 | 69.9 | <i>2.750</i> | 19.1 | <i>0.750</i> | N/A | N/A | 23.3 | <i>0.917</i> | 76.2 | <i>3.000</i> |
| MV-699254-5-8A | 5,000 | 1 | 69.9 | <i>2.750</i> | 25.4 | <i>1.000</i> | N/A | N/A | 28.6 | <i>1.125</i> | 76.2 | <i>3.000</i> |
| MV-762381-2.5-8A | 2,500 | 1 | 76.2 | <i>3.000</i> | 38.1 | <i>1.500</i> | N/A | N/A | 41.3 | <i>1.625</i> | 82.3 | <i>3.240</i> |
| MV-762508-2.5-8A | 2,500 | 1 | 76.2 | <i>3.000</i> | 50.8 | <i>2.000</i> | N/A | N/A | 54.0 | <i>2.125</i> | 82.6 | <i>3.240</i> |
| MV-762127-1-8A | 1,000 | 1 | 76.2 | <i>3.000</i> | 127.0 | <i>5.000</i> | N/A | N/A | 129.5 | <i>5.100</i> | 79.4 | <i>3.130</i> |
| MV-101508-2.5-8A | 2,500 | 1 | 101.6 | <i>4.000</i> | 50.8 | <i>2.000</i> | N/A | N/A | 54.6 | <i>2.150</i> | 104.1 | <i>4.100</i> |
| MV-101635-2.5-8A | 2,500 | 1 | 101.6 | <i>4.000</i> | 63.5 | <i>2.500</i> | N/A | N/A | 66.7 | <i>2.625</i> | 107.7 | <i>4.240</i> |
| MV-101762-1.8-8A | 1,800 | 1 | 101.6 | <i>4.000</i> | 76.2 | <i>3.000</i> | N/A | N/A | 79.4 | <i>3.125</i> | 104.1 | <i>4.100</i> |
| MV-101101-1.3-8A | 1,300 | 1 | 101.6 | <i>4.000</i> | 101.6 | <i>4.000</i> | N/A | N/A | 104.8 | <i>4.125</i> | 104.1 | <i>4.100</i> |
| MV-101165-0.85-8A | 850 | 1 | 101.6 | <i>4.000</i> | 165.1 | <i>6.500</i> | N/A | N/A | 168.3 | <i>6.680</i> | 104.9 | <i>4.130</i> |

TN Tamper proof destructible polyethylene labels

Tyco TN is a thermal transfer printable, tamper proof destructible polyethylene label with a permanent acrylic adhesive, designed to fracture upon removal after 72 hours. It is ideal for serial number labels and calibration information labeling, or other applications that require a tamper proof label. For guaranteed print performance and durability, use with Tyco's RHD series ribbon.

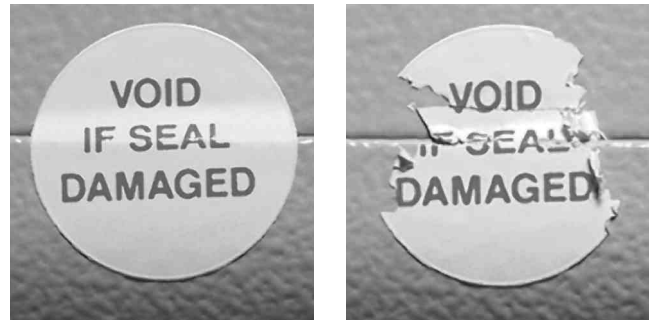

Features and benefits

- Thermal transfer printable.
- Ideal for security applications.
- Several die-cut sizes available.



| | | |
|----------------------------|--|-----------------|
| Adhesive | Permanent rubber-based | |
| Service temperature | -40°C to +80°C | -40°F to +176°F |
| Recommended printer | T308S* | |
| Recommended ribbon | 1330-0607-10* | |
| | <small>*Alternative printers and ribbons are available for special applications. Contact Tyco Electronics Identification for more information.</small> | |

Part numbering system

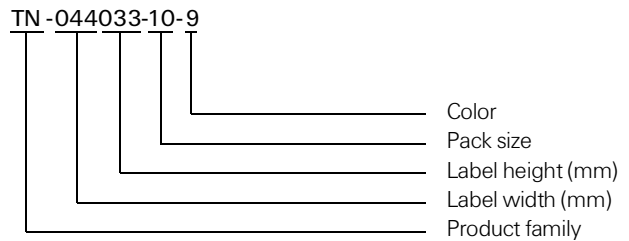

Ordering information



Product dimensions

| Product order code | Package quantity | Labels across | Label width (A) | | Label height (B) | | Horizontal repeat (C) | | Vertical repeat (D) | | Web width (E) | |
|--------------------|------------------|---------------|-----------------|---------------|------------------|---------------|-----------------------|---------------|---------------------|---------------|---------------|---------------|
| | | | mm | <i>inches</i> | mm | <i>inches</i> | mm | <i>inches</i> | mm | <i>inches</i> | mm | <i>inches</i> |
| TN-040040-25-9 | 25,000 | 20 | 4.0 | <i>0.157</i> | 4.0 | <i>0.157</i> | 4.0 | <i>0.157</i> | 7.2 | <i>0.281</i> | 86.0 | <i>3.380</i> |
| TN-044033-10-9 | 10,000 | 20 | 4.4 | <i>0.170</i> | 3.3 | <i>0.130</i> | 4.4 | <i>0.170</i> | 9.5 | <i>0.375</i> | 92.4 | <i>3.636</i> |
| TN-064064-25-9 | 25,000 | 12 | 6.4 | <i>0.250</i> | 6.4 | <i>0.250</i> | 6.4 | <i>0.250</i> | 9.5 | <i>0.375</i> | 82.2 | <i>3.240</i> |
| TN-080080-10-9 | 10,000 | 8 | 8.0 | <i>0.315</i> | 8.0 | <i>0.315</i> | 9.9 | <i>0.390</i> | 13.3 | <i>0.525</i> | 83.3 | <i>3.280</i> |
| TN-089047-10-9 | 10,000 | 5 | 8.9 | <i>0.350</i> | 4.7 | <i>0.185</i> | 11.4 | <i>0.450</i> | 7.9 | <i>0.313</i> | 60.6 | <i>2.386</i> |
| TN-095080-25-9 | 25,000 | 5 | 9.5 | <i>0.375</i> | 8.0 | <i>0.315</i> | 12.2 | <i>0.480</i> | 12.7 | <i>0.500</i> | 64.3 | <i>2.531</i> |
| TN-095095-10-9 | 10,000 | 7 | 9.5 | <i>0.375</i> | 9.5 | <i>0.375</i> | 11.1 | <i>0.437</i> | 12.7 | <i>0.500</i> | 82.1 | <i>3.230</i> |
| TN-114040-25-9 | 25,000 | 6 | 11.4 | <i>0.450</i> | 4.0 | <i>0.157</i> | 11.4 | <i>0.450</i> | 7.2 | <i>0.281</i> | 74.6 | <i>2.940</i> |
| TN-127032-10-9 | 10,000 | 5 | 12.7 | <i>0.500</i> | 3.2 | <i>0.125</i> | 19.1 | <i>0.750</i> | 3.2 | <i>0.250</i> | 94.9 | <i>3.736</i> |

(continued)

Product dimensions (continued)

| Product order code | Package quantity | Labels across | Label width (A) | | Label height (B) | | Horizontal repeat (C) | | Vertical repeat (D) | | Web width (E) | |
|--------------------|------------------|---------------|-----------------|---------------|------------------|---------------|-----------------------|---------------|---------------------|---------------|---------------|---------------|
| | | | mm | <i>inches</i> | mm | <i>inches</i> | mm | <i>inches</i> | mm | <i>inches</i> | mm | <i>inches</i> |
| TN-127111-10-9 | 10,000 | 5 | 12.7 | <i>0.500</i> | 11.1 | <i>0.437</i> | 16.8 | <i>0.662</i> | 14.3 | <i>0.563</i> | 86.0 | <i>3.380</i> |
| TN-127127-10-9 | 10,000 | 5 | 12.7 | <i>0.500</i> | 12.7 | <i>0.500</i> | 15.9 | <i>0.625</i> | 15.9 | <i>0.625</i> | 82.6 | <i>3.250</i> |
| TN-165051-25-9 | 25,000 | 4 | 16.5 | <i>0.650</i> | 5.1 | <i>0.200</i> | 17.8 | <i>0.700</i> | 8.3 | <i>0.325</i> | 75.8 | <i>2.990</i> |
| TN-165102-10-9 | 10,000 | 5 | 16.5 | <i>0.650</i> | 10.2 | <i>0.400</i> | 19.1 | <i>0.750</i> | 13.8 | <i>0.545</i> | 99.1 | <i>3.900</i> |
| TN-171171-10-9 | 10,000 | 5 | 17.1 | <i>0.674</i> | 17.1 | <i>0.674</i> | 19.7 | <i>0.774</i> | 20.3 | <i>0.800</i> | 101.8 | <i>4.006</i> |
| TN-178095-10-9 | 10,000 | 4 | 17.8 | <i>0.700</i> | 9.5 | <i>0.375</i> | 19.1 | <i>0.750</i> | 12.7 | <i>0.500</i> | 80.9 | <i>3.190</i> |
| TN-191064-10-9 | 10,000 | 4 | 19.1 | <i>0.750</i> | 6.4 | <i>0.250</i> | 21.6 | <i>0.850</i> | 9.5 | <i>0.375</i> | 89.9 | <i>3.540</i> |
| TN-191114-15-9 | 15,000 | 3 | 19.1 | <i>0.750</i> | 11.4 | <i>0.450</i> | 22.2 | <i>0.875</i> | 14.7 | <i>0.579</i> | 69.5 | <i>2.736</i> |
| TN-191762-5-9 | 5,000 | 3 | 19.1 | <i>0.750</i> | 76.2 | <i>3.000</i> | 21.6 | <i>0.850</i> | 88.9 | <i>3.500</i> | 68.2 | <i>2.686</i> |
| TN-203127-10-9 | 10,000 | 4 | 20.3 | <i>0.800</i> | 12.7 | <i>0.500</i> | 22.9 | <i>0.900</i> | 15.9 | <i>0.625</i> | 94.6 | <i>3.730</i> |
| TN-208086-5-9 | 5,000 | 4 | 20.8 | <i>0.820</i> | 8.6 | <i>0.340</i> | 24.1 | <i>0.950</i> | 12.7 | <i>0.500</i> | 101.6 | <i>4.000</i> |
| TN-222159-15-9 | 15,000 | 2 | 22.2 | <i>0.875</i> | 15.9 | <i>0.625</i> | 24.8 | <i>0.975</i> | 19.1 | <i>0.750</i> | 53.0 | <i>2.086</i> |
| TN-229064-10-9 | 10,000 | 3 | 22.9 | <i>0.900</i> | 6.4 | <i>0.250</i> | 28.6 | <i>1.125</i> | 9.5 | <i>0.375</i> | 86.0 | <i>3.390</i> |
| TN-250381-10-9 | 10,000 | 4 | 24.9 | <i>0.980</i> | 38.1 | <i>1.500</i> | 27.4 | <i>1.080</i> | 47.6 | <i>1.875</i> | 113.5 | <i>4.470</i> |
| TN-254045-10-9 | 10,000 | 3 | 25.4 | <i>1.000</i> | 4.6 | <i>0.180</i> | 31.8 | <i>1.250</i> | 8.5 | <i>0.333</i> | 95.3 | <i>3.750</i> |
| TN-254064-10-9 | 10,000 | 3 | 25.4 | <i>1.000</i> | 6.4 | <i>0.250</i> | 27.9 | <i>1.100</i> | 9.5 | <i>0.375</i> | 87.3 | <i>3.436</i> |
| TN-254097-10-9 | 10,000 | 3 | 25.4 | <i>1.000</i> | 9.7 | <i>0.380</i> | 27.9 | <i>1.100</i> | 12.7 | <i>0.500</i> | 87.4 | <i>3.440</i> |
| TN-254127-10-9 | 10,000 | 3 | 25.4 | <i>1.000</i> | 12.7 | <i>0.500</i> | 27.9 | <i>1.100</i> | 16.9 | <i>0.666</i> | 87.4 | <i>3.440</i> |
| TN-254254-10-9 | 10,000 | 3 | 25.4 | <i>1.000</i> | 25.4 | <i>1.000</i> | 27.9 | <i>1.100</i> | 28.6 | <i>1.125</i> | 87.4 | <i>3.440</i> |
| TN-305047-10-9 | 10,000 | 2 | 30.5 | <i>1.200</i> | 4.7 | <i>0.185</i> | 33.0 | <i>1.300</i> | 7.8 | <i>0.306</i> | 69.5 | <i>2.736</i> |
| TN-318064-10-9 | 10,000 | 1 | 31.8 | <i>1.250</i> | 6.4 | <i>0.250</i> | N/A | N/A | 9.5 | <i>0.375</i> | 37.9 | <i>1.490</i> |
| TN-318097-10-9 | 10,000 | 1 | 31.8 | <i>1.250</i> | 9.7 | <i>0.380</i> | N/A | N/A | 12.7 | <i>0.500</i> | 37.8 | <i>1.488</i> |
| TN-381020-10-9 | 10,000 | 1 | 38.1 | <i>1.500</i> | 2.0 | <i>0.080</i> | N/A | N/A | 10.7 | <i>0.423</i> | 44.1 | <i>1.740</i> |
| TN-381064-10-9 | 10,000 | 1 | 38.1 | <i>1.500</i> | 6.4 | <i>0.250</i> | N/A | N/A | 9.5 | <i>0.375</i> | 44.5 | <i>1.750</i> |
| TN-381127-5-9 | 5,000 | 2 | 38.1 | <i>1.500</i> | 12.7 | <i>0.500</i> | 44.2 | <i>1.738</i> | 15.9 | <i>0.625</i> | 88.2 | <i>3.472</i> |
| TN-381191-5-9 | 5,000 | 2 | 38.1 | <i>1.500</i> | 19.1 | <i>0.750</i> | 43.2 | <i>1.700</i> | 22.2 | <i>0.875</i> | 87.6 | <i>3.450</i> |
| TN-381381-2.5-9 | 2,500 | 2 | 38.1 | <i>1.500</i> | 38.1 | <i>1.500</i> | 44.5 | <i>1.750</i> | 40.8 | <i>1.607</i> | 88.9 | <i>3.500</i> |
| TN-381635-5-9 | 5,000 | 2 | 38.1 | <i>1.500</i> | 63.5 | <i>2.500</i> | 40.6 | <i>1.600</i> | 66.7 | <i>2.625</i> | 84.7 | <i>3.336</i> |
| TN-406254-1.5-9 | 1,500 | 2 | 40.6 | <i>1.600</i> | 25.4 | <i>1.000</i> | 55.9 | <i>2.200</i> | 38.1 | <i>1.500</i> | 102.9 | <i>4.050</i> |
| TN-445064-10-9 | 10,000 | 1 | 44.5 | <i>1.750</i> | 6.4 | <i>0.250</i> | N/A | N/A | 9.5 | <i>0.375</i> | 50.4 | <i>1.986</i> |
| TN-445102-5-9 | 5,000 | 1 | 44.5 | <i>1.750</i> | 10.2 | <i>0.400</i> | N/A | N/A | 12.7 | <i>0.500</i> | 50.4 | <i>1.986</i> |
| TN-445445-2-9 | 2,000 | 1 | 44.5 | <i>1.750</i> | 44.5 | <i>1.750</i> | N/A | N/A | 47.6 | <i>1.875</i> | 50.4 | <i>1.986</i> |
| TN-478175-5-9 | 5,000 | 1 | 47.8 | <i>1.880</i> | 17.5 | <i>0.690</i> | N/A | N/A | 24.4 | <i>0.962</i> | 66.0 | <i>2.600</i> |
| TN-508064-10-9 | 10,000 | 1 | 50.8 | <i>2.000</i> | 6.4 | <i>0.250</i> | N/A | N/A | 9.5 | <i>0.375</i> | 56.9 | <i>2.240</i> |
| TN-508095-5-9 | 5,000 | 1 | 50.8 | <i>2.000</i> | 9.5 | <i>0.375</i> | N/A | N/A | 12.7 | <i>0.500</i> | 57.2 | <i>2.250</i> |
| TN-508127-10-9 | 10,000 | 1 | 50.8 | <i>2.000</i> | 12.7 | <i>0.500</i> | N/A | N/A | 15.9 | <i>0.625</i> | 56.9 | <i>2.240</i> |
| TN-508254-5-9 | 5,000 | 1 | 50.8 | <i>2.000</i> | 25.4 | <i>1.000</i> | N/A | N/A | 28.6 | <i>1.125</i> | 57.2 | <i>2.250</i> |
| TN-508318-2.5-9 | 2,500 | 1 | 50.8 | <i>2.000</i> | 31.8 | <i>1.250</i> | N/A | N/A | 34.9 | <i>1.375</i> | 56.9 | <i>2.240</i> |
| TN-508508-3-9 | 3,000 | 1 | 50.8 | <i>2.000</i> | 50.8 | <i>2.000</i> | N/A | N/A | 54.6 | <i>2.150</i> | 54.0 | <i>2.130</i> |
| TN-523841-1.5-9 | 1,500 | 1 | 52.3 | <i>2.060</i> | 84.1 | <i>3.310</i> | N/A | N/A | 88.9 | <i>3.500</i> | 58.2 | <i>2.290</i> |
| TN-610419-2.5-9 | 2,500 | 1 | 61.0 | <i>2.400</i> | 41.9 | <i>1.650</i> | N/A | N/A | 45.5 | <i>1.792</i> | 67.3 | <i>2.650</i> |
| TN-699191-5-9 | 5,000 | 1 | 69.9 | <i>2.750</i> | 19.1 | <i>0.750</i> | N/A | N/A | 23.3 | <i>0.917</i> | 76.2 | <i>3.000</i> |
| TN-699254-5-9 | 5,000 | 1 | 69.9 | <i>2.750</i> | 25.4 | <i>1.000</i> | N/A | N/A | 28.6 | <i>1.125</i> | 76.2 | <i>3.000</i> |
| TN-762381-2.5-9 | 2,500 | 1 | 76.2 | <i>3.000</i> | 38.1 | <i>1.500</i> | N/A | N/A | 41.3 | <i>1.625</i> | 82.3 | <i>3.240</i> |
| TN-762508-2.5-9 | 2,500 | 1 | 76.2 | <i>3.000</i> | 50.8 | <i>2.000</i> | N/A | N/A | 54.0 | <i>2.125</i> | 82.6 | <i>3.240</i> |
| TN-762127-1-9 | 1,000 | 1 | 76.2 | <i>3.000</i> | 127.0 | <i>5.000</i> | N/A | N/A | 129.5 | <i>5.100</i> | 79.4 | <i>3.130</i> |
| TN-101508-2.5-9 | 2,500 | 1 | 101.6 | <i>4.000</i> | 50.8 | <i>2.000</i> | N/A | N/A | 54.6 | <i>2.150</i> | 104.1 | <i>4.100</i> |
| TN-101635-2.5-9 | 2,500 | 1 | 101.6 | <i>4.000</i> | 63.5 | <i>2.500</i> | N/A | N/A | 66.7 | <i>2.625</i> | 107.7 | <i>4.240</i> |
| TN-101762-1.8-9 | 1,800 | 1 | 101.6 | <i>4.000</i> | 76.2 | <i>3.000</i> | N/A | N/A | 79.4 | <i>3.125</i> | 104.1 | <i>4.100</i> |
| TN-101101-1.3-9 | 1,300 | 1 | 101.6 | <i>4.000</i> | 101.6 | <i>4.000</i> | N/A | N/A | 104.8 | <i>4.125</i> | 104.1 | <i>4.100</i> |
| TN-101165-0.85-9 | 850 | 1 | 101.6 | <i>4.000</i> | 165.1 | <i>6.500</i> | N/A | N/A | 168.3 | <i>6.680</i> | 104.9 | <i>4.130</i> |

WV White vinyl labels

Tyco WV is a thermal transfer printable, flexible white vinyl film with a permanent acrylic adhesive. It offers excellent conformability to round, irregular or flexible surfaces, and is ideal for wire and cable identification, including flat ribbon cables that are subject to repeated bending. WV is resistant to oil, mild solvents, water and outdoor exposure. For guaranteed print performance and durability use with Tyco's 3300 series ribbon.

Features and benefits

- Thermal transfer printable.
- High tack adhesive bonds to most substrates including painted metal and low surface energy plastics such as polyethylene.
- UL Listed and CSA Certified.



| | | |
|----------------------------|--|-----------------|
| Adhesive | Permanent acrylic high initial tack | |
| Service temperature | -60°C to +95°C | -76°F to +203°F |
| Recommended printer | T308S* | |
| Recommended ribbon | 1330-3300-10* | |
| | <i>*Alternative printers and ribbons are available for special applications. Contact Tyco Electronics Identification for more information.</i> | |

Part numbering system

WV-044033-10-9

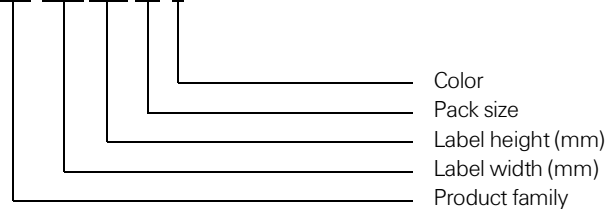

Ordering information



Product dimensions

| Product order code | Package quantity | Labels across | Label width (A) | | Label height (B) | | Horizontal repeat (C) | | Vertical repeat (D) | | Web width (E) | |
|--------------------|------------------|---------------|-----------------|---------------|------------------|---------------|-----------------------|---------------|---------------------|---------------|---------------|---------------|
| | | | mm | <i>inches</i> | mm | <i>inches</i> | mm | <i>inches</i> | mm | <i>inches</i> | mm | <i>inches</i> |
| WV-040040-25-9 | 25,000 | 20 | 4.0 | <i>0.157</i> | 4.0 | <i>0.157</i> | 4.0 | <i>0.157</i> | 7.2 | <i>0.281</i> | 86.0 | <i>3.380</i> |
| WV-044033-10-9 | 10,000 | 20 | 4.4 | <i>0.170</i> | 3.3 | <i>0.130</i> | 4.4 | <i>0.170</i> | 9.5 | <i>0.375</i> | 92.4 | <i>3.636</i> |
| WV-080080-10-9 | 10,000 | 8 | 8.0 | <i>0.315</i> | 8.0 | <i>0.315</i> | 9.9 | <i>0.390</i> | 13.3 | <i>0.525</i> | 83.3 | <i>3.280</i> |
| WV-089047-10-9 | 10,000 | 5 | 8.9 | <i>0.350</i> | 4.7 | <i>0.185</i> | 11.4 | <i>0.450</i> | 7.9 | <i>0.313</i> | 60.6 | <i>2.386</i> |
| WV-095080-25-9 | 25,000 | 5 | 9.5 | <i>0.375</i> | 8.0 | <i>0.315</i> | 12.2 | <i>0.480</i> | 12.7 | <i>0.500</i> | 64.3 | <i>2.531</i> |
| WV-095095-10-9 | 10,000 | 7 | 9.5 | <i>0.375</i> | 9.5 | <i>0.375</i> | 11.1 | <i>0.437</i> | 12.7 | <i>0.500</i> | 82.1 | <i>3.230</i> |
| WV-114040-25-9 | 25,000 | 6 | 11.4 | <i>0.450</i> | 4.0 | <i>0.157</i> | 11.4 | <i>0.450</i> | 7.2 | <i>0.281</i> | 74.6 | <i>2.940</i> |
| WV-127032-10-9 | 10,000 | 5 | 12.7 | <i>0.500</i> | 3.2 | <i>0.125</i> | 19.1 | <i>0.750</i> | 3.2 | <i>0.250</i> | 94.9 | <i>3.736</i> |
| WV-127111-10-9 | 10,000 | 5 | 12.7 | <i>0.500</i> | 11.1 | <i>0.437</i> | 16.8 | <i>0.662</i> | 14.3 | <i>0.563</i> | 86.0 | <i>3.380</i> |

(continued)

Product dimensions (continued)

| Product order code | Package quantity | Labels across | Label width (A) | | Label height (B) | | Horizontal repeat (C) | | Vertical repeat (D) | | Web width (E) | |
|--------------------|------------------|---------------|-----------------|---------------|------------------|---------------|-----------------------|---------------|---------------------|---------------|---------------|---------------|
| | | | mm | <i>inches</i> | mm | <i>inches</i> | mm | <i>inches</i> | mm | <i>inches</i> | mm | <i>inches</i> |
| WV-127127-10-9 | 10,000 | 5 | 12.7 | <i>0.500</i> | 12.7 | <i>0.500</i> | 15.9 | <i>0.625</i> | 15.9 | <i>0.625</i> | 82.6 | <i>3.250</i> |
| WV-165051-25-9 | 25,000 | 4 | 16.5 | <i>0.650</i> | 5.1 | <i>0.200</i> | 17.8 | <i>0.700</i> | 8.3 | <i>0.325</i> | 75.8 | <i>2.990</i> |
| WV-165102-10-9 | 10,000 | 5 | 16.5 | <i>0.650</i> | 10.2 | <i>0.400</i> | 19.1 | <i>0.750</i> | 13.8 | <i>0.545</i> | 99.1 | <i>3.900</i> |
| WV-171171-10-9 | 10,000 | 5 | 17.1 | <i>0.674</i> | 17.1 | <i>0.674</i> | 19.7 | <i>0.774</i> | 20.3 | <i>0.800</i> | 101.8 | <i>4.006</i> |
| WV-178095-10-9 | 10,000 | 4 | 17.8 | <i>0.700</i> | 9.5 | <i>0.375</i> | 19.1 | <i>0.750</i> | 12.7 | <i>0.500</i> | 80.9 | <i>3.190</i> |
| WV-191064-10-9 | 10,000 | 4 | 19.1 | <i>0.750</i> | 6.4 | <i>0.250</i> | 21.6 | <i>0.850</i> | 9.5 | <i>0.375</i> | 89.9 | <i>3.540</i> |
| WV-191114-15-9 | 15,000 | 3 | 19.1 | <i>0.750</i> | 11.4 | <i>0.450</i> | 22.2 | <i>0.875</i> | 14.7 | <i>0.579</i> | 69.5 | <i>2.736</i> |
| WV-191762-5-9 | 5,000 | 3 | 19.1 | <i>0.750</i> | 76.2 | <i>3.000</i> | 21.6 | <i>0.850</i> | 88.9 | <i>3.500</i> | 68.2 | <i>2.686</i> |
| WV-203127-10-9 | 10,000 | 4 | 20.3 | <i>0.800</i> | 12.7 | <i>0.500</i> | 22.9 | <i>0.900</i> | 15.9 | <i>0.625</i> | 94.6 | <i>3.730</i> |
| WV-208086-5-9 | 5,000 | 4 | 20.8 | <i>0.820</i> | 8.6 | <i>0.340</i> | 24.1 | <i>0.950</i> | 12.7 | <i>0.500</i> | 101.6 | <i>4.000</i> |
| WV-222159-15-9 | 15,000 | 2 | 22.2 | <i>0.875</i> | 15.9 | <i>0.625</i> | 24.8 | <i>0.975</i> | 19.1 | <i>0.750</i> | 53.0 | <i>2.086</i> |
| WV-229064-10-9 | 10,000 | 3 | 22.9 | <i>0.900</i> | 6.4 | <i>0.250</i> | 28.6 | <i>1.125</i> | 9.5 | <i>0.375</i> | 86.0 | <i>3.390</i> |
| WV-250381-10-9 | 10,000 | 4 | 24.9 | <i>0.980</i> | 38.1 | <i>1.500</i> | 27.4 | <i>1.080</i> | 47.6 | <i>1.875</i> | 113.5 | <i>4.470</i> |
| WV-254045-10-9 | 10,000 | 3 | 25.4 | <i>1.000</i> | 4.6 | <i>0.180</i> | 31.8 | <i>1.250</i> | 8.5 | <i>0.333</i> | 95.3 | <i>3.750</i> |
| WV-254064-10-9 | 10,000 | 3 | 25.4 | <i>1.000</i> | 6.4 | <i>0.250</i> | 27.9 | <i>1.100</i> | 9.5 | <i>0.375</i> | 87.3 | <i>3.436</i> |
| WV-254097-10-9 | 10,000 | 3 | 25.4 | <i>1.000</i> | 9.7 | <i>0.380</i> | 27.9 | <i>1.100</i> | 12.7 | <i>0.500</i> | 87.4 | <i>3.440</i> |
| WV-254127-10-9 | 10,000 | 3 | 25.4 | <i>1.000</i> | 12.7 | <i>0.500</i> | 27.9 | <i>1.100</i> | 16.9 | <i>0.666</i> | 87.4 | <i>3.440</i> |
| WV-254254-10-9 | 10,000 | 3 | 25.4 | <i>1.000</i> | 25.4 | <i>1.000</i> | 27.9 | <i>1.100</i> | 28.6 | <i>1.125</i> | 87.4 | <i>3.440</i> |
| WV-305047-10-9 | 10,000 | 2 | 30.5 | <i>1.200</i> | 4.7 | <i>0.185</i> | 33.0 | <i>1.300</i> | 7.8 | <i>0.306</i> | 69.5 | <i>2.736</i> |
| WV-318064-10-9 | 10,000 | 1 | 31.8 | <i>1.250</i> | 6.4 | <i>0.250</i> | N/A | N/A | 9.5 | <i>0.375</i> | 37.9 | <i>1.490</i> |
| WV-318097-10-9 | 10,000 | 1 | 31.8 | <i>1.250</i> | 9.7 | <i>0.380</i> | N/A | N/A | 12.7 | <i>0.500</i> | 37.8 | <i>1.488</i> |
| WV-381020-10-9 | 10,000 | 1 | 38.1 | <i>1.500</i> | 2.0 | <i>0.080</i> | N/A | N/A | 10.7 | <i>0.423</i> | 44.1 | <i>1.740</i> |
| WV-381064-10-9 | 10,000 | 1 | 38.1 | <i>1.500</i> | 6.4 | <i>0.250</i> | N/A | N/A | 9.5 | <i>0.375</i> | 44.5 | <i>1.750</i> |
| WV-381127-5-9 | 5,000 | 2 | 38.1 | <i>1.500</i> | 12.7 | <i>0.500</i> | 44.2 | <i>1.738</i> | 15.9 | <i>0.625</i> | 88.2 | <i>3.472</i> |
| WV-381191-5-9 | 5,000 | 2 | 38.1 | <i>1.500</i> | 19.1 | <i>0.750</i> | 43.2 | <i>1.700</i> | 22.2 | <i>0.875</i> | 87.6 | <i>3.450</i> |
| WV-381381-2.5-9 | 2,500 | 2 | 38.1 | <i>1.500</i> | 38.1 | <i>1.500</i> | 44.5 | <i>1.750</i> | 40.8 | <i>1.607</i> | 88.9 | <i>3.500</i> |
| WV-445064-10-9 | 10,000 | 1 | 44.5 | <i>1.750</i> | 6.4 | <i>0.250</i> | N/A | N/A | 9.5 | <i>0.375</i> | 50.4 | <i>1.986</i> |
| WV-445102-5-9 | 5,000 | 1 | 44.5 | <i>1.750</i> | 10.2 | <i>0.400</i> | N/A | N/A | 12.7 | <i>0.500</i> | 50.4 | <i>1.986</i> |
| WV-445445-2-9 | 2,000 | 1 | 44.5 | <i>1.750</i> | 44.5 | <i>1.750</i> | N/A | N/A | 47.6 | <i>1.875</i> | 50.4 | <i>1.986</i> |
| WV-478175-5-9 | 5,000 | 1 | 47.8 | <i>1.880</i> | 17.5 | <i>0.690</i> | N/A | N/A | 24.4 | <i>0.962</i> | 66.0 | <i>2.600</i> |
| WV-508064-10-9 | 10,000 | 1 | 50.8 | <i>2.000</i> | 6.4 | <i>0.250</i> | N/A | N/A | 9.5 | <i>0.375</i> | 56.9 | <i>2.240</i> |
| WV-508095-5-9 | 5,000 | 1 | 50.8 | <i>2.000</i> | 9.5 | <i>0.375</i> | N/A | N/A | 12.7 | <i>0.500</i> | 57.2 | <i>2.250</i> |
| WV-508127-10-9 | 10,000 | 1 | 50.8 | <i>2.000</i> | 12.7 | <i>0.500</i> | N/A | N/A | 15.9 | <i>0.625</i> | 56.9 | <i>2.240</i> |
| WV-508254-5-9 | 5,000 | 1 | 50.8 | <i>2.000</i> | 25.4 | <i>1.000</i> | N/A | N/A | 28.6 | <i>1.125</i> | 57.2 | <i>2.250</i> |
| WV-508318-2.5-9 | 2,500 | 1 | 50.8 | <i>2.000</i> | 31.8 | <i>1.250</i> | N/A | N/A | 34.9 | <i>1.375</i> | 56.9 | <i>2.240</i> |
| WV-508508-3-9 | 3,000 | 1 | 50.8 | <i>2.000</i> | 50.8 | <i>2.000</i> | N/A | N/A | 54.6 | <i>2.150</i> | 54.0 | <i>2.130</i> |
| WV-523841-1.5-9 | 1,500 | 1 | 52.3 | <i>2.060</i> | 84.1 | <i>3.310</i> | N/A | N/A | 88.9 | <i>3.500</i> | 58.2 | <i>2.290</i> |
| WV-610419-2.5-9 | 2,500 | 1 | 61.0 | <i>2.400</i> | 41.9 | <i>1.650</i> | N/A | N/A | 45.5 | <i>1.792</i> | 67.3 | <i>2.650</i> |
| WV-699191-5-9 | 5,000 | 1 | 69.9 | <i>2.750</i> | 19.1 | <i>0.750</i> | N/A | N/A | 23.3 | <i>0.917</i> | 76.2 | <i>3.000</i> |
| WV-699254-5-9 | 5,000 | 1 | 69.9 | <i>2.750</i> | 25.4 | <i>1.000</i> | N/A | N/A | 28.6 | <i>1.125</i> | 76.2 | <i>3.000</i> |
| WV-762381-2.5-9 | 2,500 | 1 | 76.2 | <i>3.000</i> | 38.1 | <i>1.500</i> | N/A | N/A | 41.3 | <i>1.625</i> | 82.3 | <i>3.240</i> |
| WV-762508-2.5-9 | 2,500 | 1 | 76.2 | <i>3.000</i> | 50.8 | <i>2.000</i> | N/A | N/A | 54.0 | <i>2.125</i> | 82.6 | <i>3.240</i> |
| WV-762127-1-9 | 1,000 | 1 | 76.2 | <i>3.000</i> | 127.0 | <i>5.000</i> | N/A | N/A | 129.5 | <i>5.100</i> | 79.4 | <i>3.130</i> |
| WV-101508-2.5-9 | 2,500 | 1 | 101.6 | <i>4.000</i> | 50.8 | <i>2.000</i> | N/A | N/A | 54.6 | <i>2.150</i> | 104.1 | <i>4.100</i> |
| WV-101635-2.5-9 | 2,500 | 1 | 101.6 | <i>4.000</i> | 63.5 | <i>2.500</i> | N/A | N/A | 66.7 | <i>2.625</i> | 107.7 | <i>4.240</i> |
| WV-101762-1.8-9 | 1,800 | 1 | 101.6 | <i>4.000</i> | 76.2 | <i>3.000</i> | N/A | N/A | 79.4 | <i>3.125</i> | 104.1 | <i>4.100</i> |
| WV-101101-1.3-9 | 1,300 | 1 | 101.6 | <i>4.000</i> | 101.6 | <i>4.000</i> | N/A | N/A | 104.8 | <i>4.125</i> | 104.1 | <i>4.100</i> |
| WV-101165-0.85-9 | 850 | 1 | 101.6 | <i>4.000</i> | 165.1 | <i>6.500</i> | N/A | N/A | 168.3 | <i>6.680</i> | 104.9 | <i>4.130</i> |



Electronics

Thermal Transfer

NC Nylon cloth labels

Tyco NC is a thermal transfer printable, flexible nylon cloth with a permanent acrylic adhesive, designed for application to irregular surfaces where conformability is required. It is ideal for wire marking and other round or flexible surfaces such as cables and tubing. NC is not recommended for outdoor use or immersion in liquid. For guaranteed print performance and durability, use with Tyco's RHD series ribbon.

Features and benefits

- Thermal transfer printable.
- Surface coating applied to enhance ink receptivity.
- Flexible material conforms to curved surfaces.
- Several die-cut sizes available.



| | |
|----------------------------|---------------------------------|
| Adhesive | Permanent acrylic |
| Service temperature | -40°C to +140°C -40°F to +284°F |
| Recommended printer | T308S* |
| Recommended ribbon | 1330-0607-10* |

*Alternative printers and ribbons are available for special applications. Contact Tyco Electronics Identification for more information.

Part numbering system

NC-044033-10-9

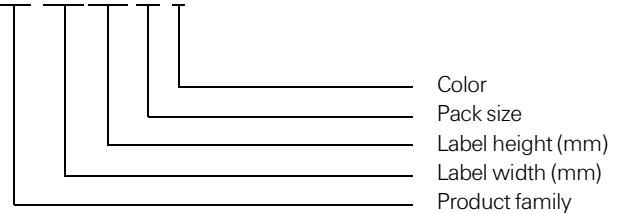

Ordering information



Product dimensions

| Product order code | Package quantity | Labels across | Label width (A) | | Label height (B) | | Horizontal repeat (C) | | Vertical repeat (D) | | Web width (E) | |
|--------------------|------------------|---------------|-----------------|---------------|------------------|---------------|-----------------------|---------------|---------------------|---------------|---------------|---------------|
| | | | mm | <i>inches</i> | mm | <i>inches</i> | mm | <i>inches</i> | mm | <i>inches</i> | mm | <i>inches</i> |
| NC-044033-10-9 | 10,000 | 20 | 4.4 | <i>0.170</i> | 3.3 | <i>0.130</i> | 4.4 | <i>0.170</i> | 9.5 | <i>0.375</i> | 92.4 | <i>3.636</i> |
| NC-064064-25-9 | 25,000 | 12 | 6.4 | <i>0.250</i> | 6.4 | <i>0.250</i> | 6.4 | <i>0.250</i> | 9.5 | <i>0.375</i> | 82.2 | <i>3.240</i> |
| NC-076191-10-9 | 10,000 | 8 | 7.6 | <i>0.300</i> | 19.1 | <i>0.750</i> | 7.6 | <i>0.300</i> | 22.2 | <i>0.875</i> | 67.3 | <i>2.650</i> |
| NC-080080-10-9 | 10,000 | 8 | 8.0 | <i>0.315</i> | 8.0 | <i>0.315</i> | 9.9 | <i>0.390</i> | 13.3 | <i>0.525</i> | 83.3 | <i>3.280</i> |
| NC-095080-25-9 | 25,000 | 5 | 9.5 | <i>0.375</i> | 8.0 | <i>0.315</i> | 12.2 | <i>0.480</i> | 12.7 | <i>0.500</i> | 64.3 | <i>2.531</i> |
| NC-095095-10-9 | 10,000 | 7 | 9.5 | <i>0.375</i> | 9.5 | <i>0.375</i> | 11.1 | <i>0.437</i> | 12.7 | <i>0.500</i> | 82.1 | <i>3.230</i> |
| NC-127032-10-9 | 10,000 | 5 | 12.7 | <i>0.500</i> | 3.2 | <i>0.125</i> | 19.1 | <i>0.750</i> | 3.2 | <i>0.250</i> | 94.9 | <i>3.736</i> |
| NC-127111-10-9 | 10,000 | 5 | 12.7 | <i>0.500</i> | 11.1 | <i>0.437</i> | 16.8 | <i>0.662</i> | 14.3 | <i>0.563</i> | 86.0 | <i>3.380</i> |
| NC-127127-10-9 | 10,000 | 5 | 12.7 | <i>0.500</i> | 12.7 | <i>0.500</i> | 15.9 | <i>0.625</i> | 15.9 | <i>0.625</i> | 82.6 | <i>3.250</i> |
| NC-165051-25-9 | 25,000 | 4 | 16.5 | <i>0.650</i> | 5.1 | <i>0.200</i> | 17.8 | <i>0.700</i> | 8.3 | <i>0.325</i> | 75.8 | <i>2.990</i> |
| NC-178095-10-9 | 10,000 | 4 | 17.8 | <i>0.700</i> | 9.5 | <i>0.375</i> | 19.1 | <i>0.750</i> | 12.7 | <i>0.500</i> | 80.9 | <i>3.190</i> |
| NC-191064-10-9 | 10,000 | 4 | 19.1 | <i>0.750</i> | 6.4 | <i>0.250</i> | 21.6 | <i>0.850</i> | 9.5 | <i>0.375</i> | 89.9 | <i>3.540</i> |
| NC-191762-5-9 | 5,000 | 3 | 19.1 | <i>0.750</i> | 76.2 | <i>3.000</i> | 21.6 | <i>0.850</i> | 88.9 | <i>3.500</i> | 68.2 | <i>2.686</i> |
| NC-229064-10-9 | 10,000 | 3 | 22.9 | <i>0.900</i> | 6.4 | <i>0.250</i> | 28.6 | <i>1.125</i> | 9.5 | <i>0.375</i> | 86.0 | <i>3.390</i> |
| NC-250381-10-9 | 10,000 | 4 | 24.9 | <i>0.980</i> | 38.1 | <i>1.500</i> | 27.4 | <i>1.080</i> | 47.6 | <i>1.875</i> | 113.5 | <i>4.470</i> |
| NC-254045-10-9 | 10,000 | 3 | 25.4 | <i>1.000</i> | 4.6 | <i>0.180</i> | 31.8 | <i>1.250</i> | 8.5 | <i>0.333</i> | 95.3 | <i>3.750</i> |
| NC-254064-10-9 | 10,000 | 3 | 25.4 | <i>1.000</i> | 6.4 | <i>0.250</i> | 27.9 | <i>1.100</i> | 9.5 | <i>0.375</i> | 87.3 | <i>3.436</i> |
| NC-254097-10-9 | 10,000 | 3 | 25.4 | <i>1.000</i> | 9.7 | <i>0.380</i> | 27.9 | <i>1.100</i> | 12.7 | <i>0.500</i> | 87.4 | <i>3.440</i> |
| NC-254127-10-9 | 10,000 | 3 | 25.4 | <i>1.000</i> | 12.7 | <i>0.500</i> | 27.9 | <i>1.100</i> | 16.9 | <i>0.666</i> | 87.4 | <i>3.440</i> |
| NC-254254-10-9 | 10,000 | 3 | 25.4 | <i>1.000</i> | 25.4 | <i>1.000</i> | 27.9 | <i>1.100</i> | 28.6 | <i>1.125</i> | 87.4 | <i>3.440</i> |
| NC-305047-10-9 | 10,000 | 2 | 30.5 | <i>1.200</i> | 4.7 | <i>0.185</i> | 33.0 | <i>1.300</i> | 7.8 | <i>0.306</i> | 69.5 | <i>2.736</i> |
| NC-318064-10-9 | 10,000 | 1 | 31.8 | <i>1.250</i> | 6.4 | <i>0.250</i> | N/A | N/A | 9.5 | <i>0.375</i> | 37.9 | <i>1.490</i> |
| NC-381020-10-9 | 10,000 | 1 | 38.1 | <i>1.500</i> | 2.0 | <i>0.080</i> | N/A | N/A | 10.7 | <i>0.423</i> | 44.1 | <i>1.740</i> |
| NC-381064-10-S1-9 | 10,000 | 1* | 38.1 | <i>1.500</i> | 6.4 | <i>0.250</i> | N/A | N/A | 9.5 | <i>0.375</i> | 44.5 | <i>1.750</i> |
| NC-381064-10-9 | 10,000 | 1 | 38.1 | <i>1.500</i> | 6.4 | <i>0.250</i> | N/A | N/A | 9.5 | <i>0.375</i> | 44.5 | <i>1.750</i> |
| NC-381127-5-9 | 5,000 | 2 | 38.1 | <i>1.500</i> | 12.7 | <i>0.500</i> | 44.2 | <i>1.738</i> | 15.9 | <i>0.625</i> | 88.2 | <i>3.472</i> |
| NC-381381-2.5-9 | 2,500 | 2 | 38.1 | <i>1.500</i> | 38.1 | <i>1.500</i> | 44.5 | <i>1.750</i> | 40.8 | <i>1.607</i> | 88.9 | <i>3.500</i> |
| NC-381635-5-9 | 5,000 | 2 | 38.1 | <i>1.500</i> | 63.5 | <i>2.500</i> | 40.6 | <i>1.600</i> | 66.7 | <i>2.625</i> | 84.7 | <i>3.336</i> |
| NC-445064-10-9 | 10,000 | 1 | 44.5 | <i>1.750</i> | 6.4 | <i>0.250</i> | N/A | N/A | 9.5 | <i>0.375</i> | 50.4 | <i>1.986</i> |
| NC-445102-5-9 | 5,000 | 1 | 44.5 | <i>1.750</i> | 10.2 | <i>0.400</i> | N/A | N/A | 12.7 | <i>0.500</i> | 50.4 | <i>1.986</i> |
| NC-445445-2-9 | 2,000 | 1 | 44.5 | <i>1.750</i> | 44.5 | <i>1.750</i> | N/A | N/A | 47.6 | <i>1.875</i> | 50.4 | <i>1.986</i> |
| NC-508064-10-9 | 10,000 | 1 | 50.8 | <i>2.000</i> | 6.4 | <i>0.250</i> | N/A | N/A | 9.5 | <i>0.375</i> | 56.9 | <i>2.240</i> |
| NC-508095-5-9 | 5,000 | 1 | 50.8 | <i>2.000</i> | 9.5 | <i>0.375</i> | N/A | N/A | 12.7 | <i>0.500</i> | 57.2 | <i>2.250</i> |
| NC-508127-10-9 | 10,000 | 1 | 50.8 | <i>2.000</i> | 12.7 | <i>0.500</i> | N/A | N/A | 15.9 | <i>0.625</i> | 56.9 | <i>2.240</i> |
| NC-508508-3-9 | 3,000 | 1 | 50.8 | <i>2.000</i> | 50.8 | <i>2.000</i> | N/A | N/A | 54.6 | <i>2.150</i> | 54.0 | <i>2.130</i> |
| NC-523841-1.5-9 | 1,500 | 1 | 52.3 | <i>2.060</i> | 84.1 | <i>3.310</i> | N/A | N/A | 88.9 | <i>3.500</i> | 58.2 | <i>2.290</i> |

*Perforated

Tyco polyimide (Kapton®) labels are all ideal for high temperature labeling requirements such as printed circuit boards. They are suitable for direct wave (bottom side) and IR reflow (top side) PCB applications. Tyco Kapton® labels are designed to withstand the fluxes, cleaning solvents and molten solder encountered in the manufacture of printed circuit boards. They offer excellent contrast for bar code applications. Tyco Kapton® labels are suitable for the harshest high temperature applications. For guaranteed print performance and durability, use with Tyco's RHT-45 series ribbon.

Features and benefits

- UL Listed.
- Thermal transfer printable.
- High temperature permanent acrylic adhesive.

T1K

- Gloss white topcoat.
- Withstands surface mount board processes on either the top or bottom side of the board.
- Low profile 1 mil film offers polyimide thermal performance at competitive cost.
- Ideal for manual apply applications.

T2K

- Gloss white topcoat.
- Withstands surface mount board processes on either the top or bottom side of the board.
- Ideal for auto apply applications.

TAK

- Gloss amber topcoat, for use where amber color is preferred.
- Withstands surface mount board processes on either the top or bottom side of the board.
- Ideal for auto apply applications.

TSK

- High opacity gloss white topcoat.
- Withstands surface mount board processes on either the top or bottom side of the board.
- Deemed to be a static safe product in accordance with EIA 625, EIA 541. Test methods employed were in accordance with EOS/ESD S11.11.
- Ideal for auto apply applications.

T2Y

- High opacity gloss white topcoat.
- Economic alternative to T1K material.
- Withstands surface mount board processes on either the top or bottom side of the board — can also be used on the top side of the board in mixed processes, *but it is not recommended for the bottom side which is directly exposed to the wave solder environment.*



KTT

- Matte tan topcoat.
- Withstands surface mount board processes on either the top or bottom side of the board.
- Product approved for aerospace/defense applications.
- Low outgassing.



| | | |
|--|---|-----------------|
| Adhesive | Permanent acrylic | |
| Service temperature | | |
| T1K ¹ , T2K ² , TAK ² , TSK ² , KTT ² | -40°C to +260°C | -40°F to +500°F |
| T2Y ³ | -40°C to +232°C | -40°F to +450°F |
| | ¹ Flash exposure to +472°C (+800°F) | |
| | ² Flash exposure to +538°C (+1000°F) | |
| | ³ Flash exposure to +316°C (+600°F) | |
| Recommended printer | | |
| T1k, T2K, TAK, TSK, T2Y T2Y, KTT | T312M* | |
| Recommended ribbon | 1330-0619-10* | |
| | *Alternative printers and ribbons are available for special applications. Contact Tyco Electronics Identification for more information. | |

Part numbering system

T1K-044033-10-9



T1K White Kapton® labels

Ordering information



Product dimensions

| Product order code | Package quantity | Labels across | Label width (A) | | Label height (B) | | Horizontal repeat (C) | | Vertical repeat (D) | | Web width (E) | |
|--------------------|------------------|---------------|-----------------|---------------|------------------|---------------|-----------------------|---------------|---------------------|---------------|---------------|---------------|
| | | | mm | <i>inches</i> | mm | <i>inches</i> | mm | <i>inches</i> | mm | <i>inches</i> | mm | <i>inches</i> |
| T1K-044033-10-9 | 10,000 | 20 | 4.4 | <i>0.170</i> | 3.3 | <i>0.130</i> | 4.4 | <i>0.170</i> | 9.5 | <i>0.375</i> | 92.4 | <i>3.636</i> |
| T1K-064064-25-9 | 25,000 | 12 | 6.4 | <i>0.250</i> | 6.4 | <i>0.250</i> | 6.4 | <i>0.250</i> | 9.5 | <i>0.375</i> | 82.2 | <i>3.240</i> |
| T1K-076191-10-9 | 10,000 | 8 | 7.6 | <i>0.300</i> | 19.1 | <i>0.750</i> | 7.6 | <i>0.300</i> | 22.2 | <i>0.875</i> | 67.3 | <i>2.650</i> |
| T1K-080080-10-9 | 10,000 | 8 | 8.0 | <i>0.315</i> | 8.0 | <i>0.315</i> | 9.9 | <i>0.390</i> | 13.3 | <i>0.525</i> | 83.3 | <i>3.280</i> |
| T1K-095080-25-9 | 25,000 | 5 | 9.5 | <i>0.375</i> | 8.0 | <i>0.315</i> | 12.2 | <i>0.480</i> | 12.7 | <i>0.500</i> | 64.3 | <i>2.531</i> |
| T1K-095095-10-9 | 10,000 | 7 | 9.5 | <i>0.375</i> | 9.5 | <i>0.375</i> | 11.1 | <i>0.437</i> | 12.7 | <i>0.500</i> | 82.1 | <i>3.230</i> |
| T1K-127032-10-9 | 10,000 | 5 | 12.7 | <i>0.500</i> | 3.2 | <i>0.125</i> | 19.1 | <i>0.750</i> | 3.2 | <i>0.250</i> | 94.9 | <i>3.736</i> |
| T1K-127111-10-9 | 10,000 | 5 | 12.7 | <i>0.500</i> | 11.1 | <i>0.437</i> | 16.8 | <i>0.662</i> | 14.3 | <i>0.563</i> | 86.0 | <i>3.380</i> |
| T1K-127127-10-9 | 10,000 | 5 | 12.7 | <i>0.500</i> | 12.7 | <i>0.500</i> | 15.9 | <i>0.625</i> | 15.9 | <i>0.625</i> | 82.6 | <i>3.250</i> |
| T1K-165051-25-9 | 25,000 | 4 | 16.5 | <i>0.650</i> | 5.1 | <i>0.200</i> | 17.8 | <i>0.700</i> | 8.3 | <i>0.325</i> | 75.8 | <i>2.990</i> |
| T1K-171171-10-9 | 10,000 | 5 | 17.1 | <i>0.674</i> | 17.1 | <i>0.674</i> | 19.7 | <i>0.774</i> | 20.3 | <i>0.800</i> | 101.8 | <i>4.006</i> |
| T1K-178095-10-9 | 10,000 | 4 | 17.8 | <i>0.700</i> | 9.5 | <i>0.375</i> | 19.1 | <i>0.750</i> | 12.7 | <i>0.500</i> | 80.9 | <i>3.190</i> |
| T1K-191064-10-9 | 10,000 | 4 | 19.1 | <i>0.750</i> | 6.4 | <i>0.250</i> | 21.6 | <i>0.850</i> | 9.5 | <i>0.375</i> | 89.9 | <i>3.540</i> |
| T1K-191762-5-9 | 5,000 | 3 | 19.1 | <i>0.750</i> | 76.2 | <i>3.000</i> | 21.6 | <i>0.850</i> | 88.9 | <i>3.500</i> | 68.2 | <i>2.686</i> |
| T1K-229064-10-9 | 10,000 | 3 | 22.9 | <i>0.900</i> | 6.4 | <i>0.250</i> | 28.6 | <i>1.125</i> | 9.5 | <i>0.375</i> | 86.0 | <i>3.390</i> |
| T1K-250381-10-9 | 10,000 | 4 | 24.9 | <i>0.980</i> | 38.1 | <i>1.500</i> | 27.4 | <i>1.080</i> | 47.6 | <i>1.875</i> | 113.5 | <i>4.470</i> |
| T1K-254045-10-9 | 10,000 | 3 | 25.4 | <i>1.000</i> | 4.6 | <i>0.180</i> | 31.8 | <i>1.250</i> | 8.5 | <i>0.333</i> | 95.3 | <i>3.750</i> |
| T1K-254064-10-9 | 10,000 | 3 | 25.4 | <i>1.000</i> | 6.4 | <i>0.250</i> | 27.9 | <i>1.100</i> | 9.5 | <i>0.375</i> | 87.3 | <i>3.436</i> |
| T1K-254097-10-9 | 10,000 | 3 | 25.4 | <i>1.000</i> | 9.7 | <i>0.380</i> | 27.9 | <i>1.100</i> | 12.7 | <i>0.500</i> | 87.4 | <i>3.440</i> |
| T1K-254127-10-9 | 10,000 | 3 | 25.4 | <i>1.000</i> | 12.7 | <i>0.500</i> | 27.9 | <i>1.100</i> | 16.9 | <i>0.666</i> | 87.4 | <i>3.440</i> |
| T1K-254254-10-9 | 10,000 | 3 | 25.4 | <i>1.000</i> | 25.4 | <i>1.000</i> | 27.9 | <i>1.100</i> | 28.6 | <i>1.125</i> | 87.4 | <i>3.440</i> |
| T1K-305047-10-9 | 10,000 | 2 | 30.5 | <i>1.200</i> | 4.7 | <i>0.185</i> | 33.0 | <i>1.300</i> | 7.8 | <i>0.306</i> | 69.5 | <i>2.736</i> |
| T1K-318064-10-9 | 10,000 | 1 | 31.8 | <i>1.250</i> | 6.4 | <i>0.250</i> | N/A | N/A | 9.5 | <i>0.375</i> | 37.9 | <i>1.490</i> |
| T1K-381020-10-9 | 10,000 | 1 | 38.1 | <i>1.500</i> | 2.0 | <i>0.080</i> | N/A | N/A | 10.7 | <i>0.423</i> | 44.1 | <i>1.740</i> |
| T1K-381127-5-9 | 5,000 | 2 | 38.1 | <i>1.500</i> | 12.7 | <i>0.500</i> | 44.2 | <i>1.738</i> | 15.9 | <i>0.625</i> | 88.2 | <i>3.472</i> |
| T1K-381381-2.5-9 | 2,500 | 2 | 38.1 | <i>1.500</i> | 38.1 | <i>1.500</i> | 44.5 | <i>1.750</i> | 40.8 | <i>1.607</i> | 88.9 | <i>3.500</i> |
| T1K-381635-5-9 | 5,000 | 2 | 38.1 | <i>1.500</i> | 63.5 | <i>2.500</i> | 40.6 | <i>1.600</i> | 66.7 | <i>2.625</i> | 84.7 | <i>3.336</i> |
| T1K-445064-10-9 | 10,000 | 1 | 44.5 | <i>1.750</i> | 6.4 | <i>0.250</i> | N/A | N/A | 9.5 | <i>0.375</i> | 50.4 | <i>1.986</i> |
| T1K-445102-5-9 | 5,000 | 1 | 44.5 | <i>1.750</i> | 10.2 | <i>0.400</i> | N/A | N/A | 12.7 | <i>0.500</i> | 50.4 | <i>1.986</i> |
| T1K-445445-2-9 | 2,000 | 1 | 44.5 | <i>1.750</i> | 44.5 | <i>1.750</i> | N/A | N/A | 47.6 | <i>1.875</i> | 50.4 | <i>1.986</i> |
| T1K-508064-10-9 | 10,000 | 1 | 50.8 | <i>2.000</i> | 6.4 | <i>0.250</i> | N/A | N/A | 9.5 | <i>0.375</i> | 56.9 | <i>2.240</i> |
| T1K-508095-5-9 | 5,000 | 1 | 50.8 | <i>2.000</i> | 9.5 | <i>0.375</i> | N/A | N/A | 12.7 | <i>0.500</i> | 57.2 | <i>2.250</i> |
| T1K-508127-10-9 | 10,000 | 1 | 50.8 | <i>2.000</i> | 12.7 | <i>0.500</i> | N/A | N/A | 15.9 | <i>0.625</i> | 56.9 | <i>2.240</i> |
| T1K-508508-3-9 | 3,000 | 1 | 50.8 | <i>2.000</i> | 50.8 | <i>2.000</i> | N/A | N/A | 54.6 | <i>2.150</i> | 54.0 | <i>2.130</i> |
| T1K-523841-1.5-9 | 1,500 | 1 | 52.3 | <i>2.060</i> | 84.1 | <i>3.310</i> | N/A | N/A | 88.9 | <i>3.500</i> | 58.2 | <i>2.290</i> |

Ordering information



Product dimensions

| Product order code | Package quantity | Labels across | Label width (A) | | Label height (B) | | Horizontal repeat (C) | | Vertical repeat (D) | | Web width (E) | |
|--------------------|------------------|---------------|-----------------|---------------|------------------|---------------|-----------------------|---------------|---------------------|---------------|---------------|---------------|
| | | | mm | <i>inches</i> | mm | <i>inches</i> | mm | <i>inches</i> | mm | <i>inches</i> | mm | <i>inches</i> |
| T2K-044033-10-9 | 10,000 | 20 | 4.4 | <i>0.170</i> | 3.3 | <i>0.130</i> | 4.4 | <i>0.170</i> | 9.5 | <i>0.375</i> | 92.4 | <i>3.636</i> |
| T2K-064064-25-9 | 25,000 | 12 | 6.4 | <i>0.250</i> | 6.4 | <i>0.250</i> | 6.4 | <i>0.250</i> | 9.5 | <i>0.375</i> | 82.2 | <i>3.240</i> |
| T2K-076191-10-9 | 10,000 | 8 | 7.6 | <i>0.300</i> | 19.1 | <i>0.750</i> | 7.6 | <i>0.300</i> | 22.2 | <i>0.875</i> | 67.3 | <i>2.650</i> |
| T2K-080080-10-9 | 10,000 | 8 | 8.0 | <i>0.315</i> | 8.0 | <i>0.315</i> | 9.9 | <i>0.390</i> | 13.3 | <i>0.525</i> | 83.3 | <i>3.280</i> |
| T2K-095080-25-9 | 25,000 | 5 | 9.5 | <i>0.375</i> | 8.0 | <i>0.315</i> | 12.2 | <i>0.480</i> | 12.7 | <i>0.500</i> | 64.3 | <i>2.531</i> |
| T2K-095095-10-9 | 10,000 | 7 | 9.5 | <i>0.375</i> | 9.5 | <i>0.375</i> | 11.1 | <i>0.437</i> | 12.7 | <i>0.500</i> | 82.1 | <i>3.230</i> |
| T2K-127032-10-9 | 10,000 | 5 | 12.7 | <i>0.500</i> | 3.2 | <i>0.125</i> | 19.1 | <i>0.750</i> | 3.2 | <i>0.250</i> | 94.9 | <i>3.736</i> |
| T2K-127111-10-9 | 10,000 | 5 | 12.7 | <i>0.500</i> | 11.1 | <i>0.437</i> | 16.8 | <i>0.662</i> | 14.3 | <i>0.563</i> | 86.0 | <i>3.380</i> |
| T2K-127127-10-9 | 10,000 | 5 | 12.7 | <i>0.500</i> | 12.7 | <i>0.500</i> | 15.9 | <i>0.625</i> | 15.9 | <i>0.625</i> | 82.6 | <i>3.250</i> |
| T2K-165051-25-9 | 25,000 | 4 | 16.5 | <i>0.650</i> | 5.1 | <i>0.200</i> | 17.8 | <i>0.700</i> | 8.3 | <i>0.325</i> | 75.8 | <i>2.990</i> |
| T2K-171171-10-9 | 10,000 | 5 | 17.1 | <i>0.674</i> | 17.1 | <i>0.674</i> | 19.7 | <i>0.774</i> | 20.3 | <i>0.800</i> | 101.8 | <i>4.006</i> |
| T2K-178095-10-9 | 10,000 | 4 | 17.8 | <i>0.700</i> | 9.5 | <i>0.375</i> | 19.1 | <i>0.750</i> | 12.7 | <i>0.500</i> | 80.9 | <i>3.190</i> |
| T2K-191064-10-9 | 10,000 | 4 | 19.1 | <i>0.750</i> | 6.4 | <i>0.250</i> | 21.6 | <i>0.850</i> | 9.5 | <i>0.375</i> | 89.9 | <i>3.540</i> |
| T2K-191762-5-9 | 5,000 | 3 | 19.1 | <i>0.750</i> | 76.2 | <i>3.000</i> | 21.6 | <i>0.850</i> | 88.9 | <i>3.500</i> | 68.2 | <i>2.686</i> |
| T2K-229064-10-9 | 10,000 | 3 | 22.9 | <i>0.900</i> | 6.4 | <i>0.250</i> | 28.6 | <i>1.125</i> | 9.5 | <i>0.375</i> | 86.0 | <i>3.390</i> |
| T2K-250381-10-9 | 10,000 | 4 | 24.9 | <i>0.980</i> | 38.1 | <i>1.500</i> | 27.4 | <i>1.080</i> | 47.6 | <i>1.875</i> | 113.5 | <i>4.470</i> |
| T2K-254045-10-9 | 10,000 | 3 | 25.4 | <i>1.000</i> | 4.6 | <i>0.180</i> | 31.8 | <i>1.250</i> | 8.5 | <i>0.333</i> | 95.3 | <i>3.750</i> |
| T2K-254064-10-9 | 10,000 | 3 | 25.4 | <i>1.000</i> | 6.4 | <i>0.250</i> | 27.9 | <i>1.100</i> | 9.5 | <i>0.375</i> | 87.3 | <i>3.436</i> |
| T2K-254097-10-9 | 10,000 | 3 | 25.4 | <i>1.000</i> | 9.7 | <i>0.380</i> | 27.9 | <i>1.100</i> | 12.7 | <i>0.500</i> | 87.4 | <i>3.440</i> |
| T2K-254127-10-9 | 10,000 | 3 | 25.4 | <i>1.000</i> | 12.7 | <i>0.500</i> | 27.9 | <i>1.100</i> | 16.9 | <i>0.666</i> | 87.4 | <i>3.440</i> |
| T2K-254254-10-9 | 10,000 | 3 | 25.4 | <i>1.000</i> | 25.4 | <i>1.000</i> | 27.9 | <i>1.100</i> | 28.6 | <i>1.125</i> | 87.4 | <i>3.440</i> |
| T2K-305047-10-9 | 10,000 | 2 | 30.5 | <i>1.200</i> | 4.7 | <i>0.185</i> | 33.0 | <i>1.300</i> | 7.8 | <i>0.306</i> | 69.5 | <i>2.736</i> |
| T2K-318064-10-9 | 10,000 | 1 | 31.8 | <i>1.250</i> | 6.4 | <i>0.250</i> | N/A | N/A | 9.5 | <i>0.375</i> | 37.9 | <i>1.490</i> |
| T2K-381020-10-9 | 10,000 | 1 | 38.1 | <i>1.500</i> | 2.0 | <i>0.080</i> | N/A | N/A | 10.7 | <i>0.423</i> | 44.1 | <i>1.740</i> |
| T2K-381064-10-9 | 10,000 | 1 | 38.1 | <i>1.500</i> | 6.4 | <i>0.250</i> | N/A | N/A | 9.5 | <i>0.375</i> | 44.5 | <i>1.750</i> |
| T2K-381127-5-9 | 5,000 | 2 | 38.1 | <i>1.500</i> | 12.7 | <i>0.500</i> | 44.2 | <i>1.738</i> | 15.9 | <i>0.625</i> | 88.2 | <i>3.472</i> |
| T2K-381381-2.5-9 | 2,500 | 2 | 38.1 | <i>1.500</i> | 38.1 | <i>1.500</i> | 44.5 | <i>1.750</i> | 40.8 | <i>1.607</i> | 88.9 | <i>3.500</i> |
| T2K-381635-5-9 | 5,000 | 2 | 38.1 | <i>1.500</i> | 63.5 | <i>2.500</i> | 40.6 | <i>1.600</i> | 66.7 | <i>2.625</i> | 84.7 | <i>3.336</i> |
| T2K-445064-10-9 | 10,000 | 1 | 44.5 | <i>1.750</i> | 6.4 | <i>0.250</i> | N/A | N/A | 9.5 | <i>0.375</i> | 50.4 | <i>1.986</i> |
| T2K-445102-5-9 | 5,000 | 1 | 44.5 | <i>1.750</i> | 10.2 | <i>0.400</i> | N/A | N/A | 12.7 | <i>0.500</i> | 50.4 | <i>1.986</i> |
| T2K-445445-2-9 | 2,000 | 1 | 44.5 | <i>1.750</i> | 44.5 | <i>1.750</i> | N/A | N/A | 47.6 | <i>1.875</i> | 50.4 | <i>1.986</i> |
| T2K-508064-10-9 | 10,000 | 1 | 50.8 | <i>2.000</i> | 6.4 | <i>0.250</i> | N/A | N/A | 9.5 | <i>0.375</i> | 56.9 | <i>2.240</i> |
| T2K-508095-5-9 | 5,000 | 1 | 50.8 | <i>2.000</i> | 9.5 | <i>0.375</i> | N/A | N/A | 12.7 | <i>0.500</i> | 57.2 | <i>2.250</i> |
| T2K-508127-10-9 | 10,000 | 1 | 50.8 | <i>2.000</i> | 12.7 | <i>0.500</i> | N/A | N/A | 15.9 | <i>0.625</i> | 56.9 | <i>2.240</i> |
| T2K-508508-3-9 | 3,000 | 1 | 50.8 | <i>2.000</i> | 50.8 | <i>2.000</i> | N/A | N/A | 54.6 | <i>2.150</i> | 54.0 | <i>2.130</i> |
| T2K-523841-1.5-9 | 1,500 | 1 | 52.3 | <i>2.060</i> | 84.1 | <i>3.310</i> | N/A | N/A | 88.9 | <i>3.500</i> | 58.2 | <i>2.290</i> |

Ordering information



Product dimensions

| Product order code | Package quantity | Labels across | Label width (A) | | Label height (B) | | Horizontal repeat (C) | | Vertical repeat (D) | | Web width (E) | |
|--------------------|------------------|---------------|-----------------|---------------|------------------|---------------|-----------------------|---------------|---------------------|---------------|---------------|---------------|
| | | | mm | <i>inches</i> | mm | <i>inches</i> | mm | <i>inches</i> | mm | <i>inches</i> | mm | <i>inches</i> |
| TAK-044033-10-3A | 10,000 | 20 | 4.4 | <i>0.170</i> | 3.3 | <i>0.130</i> | 4.4 | <i>0.170</i> | 9.5 | <i>0.375</i> | 92.4 | <i>3.636</i> |
| TAK-064064-25-3A | 25,000 | 12 | 6.4 | <i>0.250</i> | 6.4 | <i>0.250</i> | 6.4 | <i>0.250</i> | 9.5 | <i>0.375</i> | 82.2 | <i>3.240</i> |
| TAK-076191-10-3A | 10,000 | 8 | 7.6 | <i>0.300</i> | 19.1 | <i>0.750</i> | 7.6 | <i>0.300</i> | 22.2 | <i>0.875</i> | 67.3 | <i>2.650</i> |
| TAK-080080-10-3A | 10,000 | 8 | 8.0 | <i>0.315</i> | 8.0 | <i>0.315</i> | 9.9 | <i>0.390</i> | 13.3 | <i>0.525</i> | 83.3 | <i>3.280</i> |
| TAK-095080-25-3A | 25,000 | 5 | 9.5 | <i>0.375</i> | 8.0 | <i>0.315</i> | 12.2 | <i>0.480</i> | 12.7 | <i>0.500</i> | 64.3 | <i>2.531</i> |
| TAK-095095-10-3A | 10,000 | 7 | 9.5 | <i>0.375</i> | 9.5 | <i>0.375</i> | 11.1 | <i>0.437</i> | 12.7 | <i>0.500</i> | 82.1 | <i>3.230</i> |
| TAK-127032-10-3A | 10,000 | 5 | 12.7 | <i>0.500</i> | 3.2 | <i>0.125</i> | 19.1 | <i>0.750</i> | 3.2 | <i>0.250</i> | 94.9 | <i>3.736</i> |
| TAK-127111-10-3A | 10,000 | 5 | 12.7 | <i>0.500</i> | 11.1 | <i>0.437</i> | 16.8 | <i>0.662</i> | 14.3 | <i>0.563</i> | 86.0 | <i>3.380</i> |
| TAK-127127-10-3A | 10,000 | 5 | 12.7 | <i>0.500</i> | 12.7 | <i>0.500</i> | 15.9 | <i>0.625</i> | 15.9 | <i>0.625</i> | 82.6 | <i>3.250</i> |
| TAK-165051-25-3A | 25,000 | 4 | 16.5 | <i>0.650</i> | 5.1 | <i>0.200</i> | 17.8 | <i>0.700</i> | 8.3 | <i>0.325</i> | 75.8 | <i>2.990</i> |
| TAK-171171-10-3A | 10,000 | 5 | 17.1 | <i>0.674</i> | 17.1 | <i>0.674</i> | 19.7 | <i>0.774</i> | 20.3 | <i>0.800</i> | 101.8 | <i>4.006</i> |
| TAK-178095-10-3A | 10,000 | 4 | 17.8 | <i>0.700</i> | 9.5 | <i>0.375</i> | 19.1 | <i>0.750</i> | 12.7 | <i>0.500</i> | 80.9 | <i>3.190</i> |
| TAK-191064-10-3A | 10,000 | 4 | 19.1 | <i>0.750</i> | 6.4 | <i>0.250</i> | 21.6 | <i>0.850</i> | 9.5 | <i>0.375</i> | 89.9 | <i>3.540</i> |
| TAK-191762-5-3A | 5,000 | 3 | 19.1 | <i>0.750</i> | 76.2 | <i>3.000</i> | 21.6 | <i>0.850</i> | 88.9 | <i>3.500</i> | 68.2 | <i>2.686</i> |
| TAK-229064-10-3A | 10,000 | 3 | 22.9 | <i>0.900</i> | 6.4 | <i>0.250</i> | 28.6 | <i>1.125</i> | 9.5 | <i>0.375</i> | 86.0 | <i>3.390</i> |
| TAK-250381-10-3A | 10,000 | 4 | 24.9 | <i>0.980</i> | 38.1 | <i>1.500</i> | 27.4 | <i>1.080</i> | 47.6 | <i>1.875</i> | 113.5 | <i>4.470</i> |
| TAK-254045-10-3A | 10,000 | 3 | 25.4 | <i>1.000</i> | 4.6 | <i>0.180</i> | 31.8 | <i>1.250</i> | 8.5 | <i>0.333</i> | 95.3 | <i>3.750</i> |
| TAK-254064-10-3A | 10,000 | 3 | 25.4 | <i>1.000</i> | 6.4 | <i>0.250</i> | 27.9 | <i>1.100</i> | 9.5 | <i>0.375</i> | 87.3 | <i>3.436</i> |
| TAK-254097-10-3A | 10,000 | 3 | 25.4 | <i>1.000</i> | 9.7 | <i>0.380</i> | 27.9 | <i>1.100</i> | 12.7 | <i>0.500</i> | 87.4 | <i>3.440</i> |
| TAK-254127-10-3A | 10,000 | 3 | 25.4 | <i>1.000</i> | 12.7 | <i>0.500</i> | 27.9 | <i>1.100</i> | 16.9 | <i>0.666</i> | 87.4 | <i>3.440</i> |
| TAK-254254-10-3A | 10,000 | 3 | 25.4 | <i>1.000</i> | 25.4 | <i>1.000</i> | 27.9 | <i>1.100</i> | 28.6 | <i>1.125</i> | 87.4 | <i>3.440</i> |
| TAK-305047-10-3A | 10,000 | 2 | 30.5 | <i>1.200</i> | 4.7 | <i>0.185</i> | 33.0 | <i>1.300</i> | 7.8 | <i>0.306</i> | 69.5 | <i>2.736</i> |
| TAK-318064-10-3A | 10,000 | 1 | 31.8 | <i>1.250</i> | 6.4 | <i>0.250</i> | N/A | N/A | 9.5 | <i>0.375</i> | 37.9 | <i>1.490</i> |
| TAK-381020-10-3A | 10,000 | 1 | 38.1 | <i>1.500</i> | 2.0 | <i>0.080</i> | N/A | N/A | 10.7 | <i>0.423</i> | 44.1 | <i>1.740</i> |
| TAK-381064-10-3A | 10,000 | 1 | 38.1 | <i>1.500</i> | 6.4 | <i>0.250</i> | N/A | N/A | 9.5 | <i>0.375</i> | 44.5 | <i>1.750</i> |
| TAK-381127-5-3A | 5,000 | 2 | 38.1 | <i>1.500</i> | 12.7 | <i>0.500</i> | 44.2 | <i>1.738</i> | 15.9 | <i>0.625</i> | 88.2 | <i>3.472</i> |
| TAK-381381-2.5-3A | 2,500 | 2 | 38.1 | <i>1.500</i> | 38.1 | <i>1.500</i> | 44.5 | <i>1.750</i> | 40.8 | <i>1.607</i> | 88.9 | <i>3.500</i> |
| TAK-381635-5-3A | 5,000 | 2 | 38.1 | <i>1.500</i> | 63.5 | <i>2.500</i> | 40.6 | <i>1.600</i> | 66.7 | <i>2.625</i> | 84.7 | <i>3.336</i> |
| TAK-445064-10-3A | 10,000 | 1 | 44.5 | <i>1.750</i> | 6.4 | <i>0.250</i> | N/A | N/A | 9.5 | <i>0.375</i> | 50.4 | <i>1.986</i> |
| TAK-445102-5-3A | 5,000 | 1 | 44.5 | <i>1.750</i> | 10.2 | <i>0.400</i> | N/A | N/A | 12.7 | <i>0.500</i> | 50.4 | <i>1.986</i> |
| TAK-445445-2-3A | 2,000 | 1 | 44.5 | <i>1.750</i> | 44.5 | <i>1.750</i> | N/A | N/A | 47.6 | <i>1.875</i> | 50.4 | <i>1.986</i> |
| TAK-508064-10-3A | 10,000 | 1 | 50.8 | <i>2.000</i> | 6.4 | <i>0.250</i> | N/A | N/A | 9.5 | <i>0.375</i> | 56.9 | <i>2.240</i> |
| TAK-508095-5-3A | 5,000 | 1 | 50.8 | <i>2.000</i> | 9.5 | <i>0.375</i> | N/A | N/A | 12.7 | <i>0.500</i> | 57.2 | <i>2.250</i> |
| TAK-508127-10-3A | 10,000 | 1 | 50.8 | <i>2.000</i> | 12.7 | <i>0.500</i> | N/A | N/A | 15.9 | <i>0.625</i> | 56.9 | <i>2.240</i> |
| TAK-508508-3-3A | 3,000 | 1 | 50.8 | <i>2.000</i> | 50.8 | <i>2.000</i> | N/A | N/A | 54.6 | <i>2.150</i> | 54.0 | <i>2.130</i> |
| TAK-523841-1.5-3A | 1,500 | 1 | 52.3 | <i>2.060</i> | 84.1 | <i>3.310</i> | N/A | N/A | 88.9 | <i>3.500</i> | 58.2 | <i>2.290</i> |

Ordering information



Product dimensions

| Product order code | Package quantity | Labels across | Label width (A) | | Label height (B) | | Horizontal repeat (C) | | Vertical repeat (D) | | Web width (E) | |
|--------------------|------------------|---------------|-----------------|---------------|------------------|---------------|-----------------------|---------------|---------------------|---------------|---------------|---------------|
| | | | mm | <i>inches</i> | mm | <i>inches</i> | mm | <i>inches</i> | mm | <i>inches</i> | mm | <i>inches</i> |
| TSK-044033-10-9 | 10,000 | 20 | 4.4 | <i>0.170</i> | 3.3 | <i>0.130</i> | 4.4 | <i>0.170</i> | 9.5 | <i>0.375</i> | 92.4 | <i>3.636</i> |
| TSK-064064-25-9 | 25,000 | 12 | 6.4 | <i>0.250</i> | 6.4 | <i>0.250</i> | 6.4 | <i>0.250</i> | 9.5 | <i>0.375</i> | 82.2 | <i>3.240</i> |
| TSK-076191-10-9 | 10,000 | 8 | 7.6 | <i>0.300</i> | 19.1 | <i>0.750</i> | 7.6 | <i>0.300</i> | 22.2 | <i>0.875</i> | 67.3 | <i>2.650</i> |
| TSK-080080-10-9 | 10,000 | 8 | 8.0 | <i>0.315</i> | 8.0 | <i>0.315</i> | 9.9 | <i>0.390</i> | 13.3 | <i>0.525</i> | 83.3 | <i>3.280</i> |
| TSK-095080-25-9 | 25,000 | 5 | 9.5 | <i>0.375</i> | 8.0 | <i>0.315</i> | 12.2 | <i>0.480</i> | 12.7 | <i>0.500</i> | 64.3 | <i>2.531</i> |
| TSK-095095-10-9 | 10,000 | 7 | 9.5 | <i>0.375</i> | 9.5 | <i>0.375</i> | 11.1 | <i>0.437</i> | 12.7 | <i>0.500</i> | 82.1 | <i>3.230</i> |
| TSK-127032-10-9 | 10,000 | 5 | 12.7 | <i>0.500</i> | 3.2 | <i>0.125</i> | 19.1 | <i>0.750</i> | 3.2 | <i>0.250</i> | 94.9 | <i>3.736</i> |
| TSK-127111-10-9 | 10,000 | 5 | 12.7 | <i>0.500</i> | 11.1 | <i>0.437</i> | 16.8 | <i>0.662</i> | 14.3 | <i>0.563</i> | 86.0 | <i>3.380</i> |
| TSK-127127-10-9 | 10,000 | 5 | 12.7 | <i>0.500</i> | 12.7 | <i>0.500</i> | 15.9 | <i>0.625</i> | 15.9 | <i>0.625</i> | 82.6 | <i>3.250</i> |
| TSK-165051-25-9 | 25,000 | 4 | 16.5 | <i>0.650</i> | 5.1 | <i>0.200</i> | 17.8 | <i>0.700</i> | 8.3 | <i>0.325</i> | 75.8 | <i>2.990</i> |
| TSK-171171-10-9 | 10,000 | 5 | 17.1 | <i>0.674</i> | 17.1 | <i>0.674</i> | 19.7 | <i>0.774</i> | 20.3 | <i>0.800</i> | 101.8 | <i>4.006</i> |
| TSK-178095-10-9 | 10,000 | 4 | 17.8 | <i>0.700</i> | 9.5 | <i>0.375</i> | 19.1 | <i>0.750</i> | 12.7 | <i>0.500</i> | 80.9 | <i>3.190</i> |
| TSK-191064-10-9 | 10,000 | 4 | 19.1 | <i>0.750</i> | 6.4 | <i>0.250</i> | 21.6 | <i>0.850</i> | 9.5 | <i>0.375</i> | 89.9 | <i>3.540</i> |
| TSK-191762-5-9 | 5,000 | 3 | 19.1 | <i>0.750</i> | 76.2 | <i>3.000</i> | 21.6 | <i>0.850</i> | 88.9 | <i>3.500</i> | 68.2 | <i>2.686</i> |
| TSK-229064-10-9 | 10,000 | 3 | 22.9 | <i>0.900</i> | 6.4 | <i>0.250</i> | 28.6 | <i>1.125</i> | 9.5 | <i>0.375</i> | 86.0 | <i>3.390</i> |
| TSK-250381-10-9 | 10,000 | 4 | 24.9 | <i>0.980</i> | 38.1 | <i>1.500</i> | 27.4 | <i>1.080</i> | 47.6 | <i>1.875</i> | 113.5 | <i>4.470</i> |
| TSK-254045-10-9 | 10,000 | 3 | 25.4 | <i>1.000</i> | 4.6 | <i>0.180</i> | 31.8 | <i>1.250</i> | 8.5 | <i>0.333</i> | 95.3 | <i>3.750</i> |
| TSK-254064-10-9 | 10,000 | 3 | 25.4 | <i>1.000</i> | 6.4 | <i>0.250</i> | 27.9 | <i>1.100</i> | 9.5 | <i>0.375</i> | 87.3 | <i>3.436</i> |
| TSK-254097-10-9 | 10,000 | 3 | 25.4 | <i>1.000</i> | 9.7 | <i>0.380</i> | 27.9 | <i>1.100</i> | 12.7 | <i>0.500</i> | 87.4 | <i>3.440</i> |
| TSK-254127-10-9 | 10,000 | 3 | 25.4 | <i>1.000</i> | 12.7 | <i>0.500</i> | 27.9 | <i>1.100</i> | 16.9 | <i>0.666</i> | 87.4 | <i>3.440</i> |
| TSK-254254-10-9 | 10,000 | 3 | 25.4 | <i>1.000</i> | 25.4 | <i>1.000</i> | 27.9 | <i>1.100</i> | 28.6 | <i>1.125</i> | 87.4 | <i>3.440</i> |
| TSK-305047-10-9 | 10,000 | 2 | 30.5 | <i>1.200</i> | 4.7 | <i>0.185</i> | 33.0 | <i>1.300</i> | 7.8 | <i>0.306</i> | 69.5 | <i>2.736</i> |
| TSK-318064-10-9 | 10,000 | 1 | 31.8 | <i>1.250</i> | 6.4 | <i>0.250</i> | N/A | N/A | 9.5 | <i>0.375</i> | 37.9 | <i>1.490</i> |
| TSK-381020-10-9 | 10,000 | 1 | 38.1 | <i>1.500</i> | 2.0 | <i>0.080</i> | N/A | N/A | 10.7 | <i>0.423</i> | 44.1 | <i>1.740</i> |
| TSK-381064-10-9 | 10,000 | 1 | 38.1 | <i>1.500</i> | 6.4 | <i>0.250</i> | N/A | N/A | 9.5 | <i>0.375</i> | 44.5 | <i>1.750</i> |
| TSK-381127-5-9 | 5,000 | 2 | 38.1 | <i>1.500</i> | 12.7 | <i>0.500</i> | 44.2 | <i>1.738</i> | 15.9 | <i>0.625</i> | 88.2 | <i>3.472</i> |
| TSK-381381-2.5-9 | 2,500 | 2 | 38.1 | <i>1.500</i> | 38.1 | <i>1.500</i> | 44.5 | <i>1.750</i> | 40.8 | <i>1.607</i> | 88.9 | <i>3.500</i> |
| TSK-381635-5-9 | 5,000 | 2 | 38.1 | <i>1.500</i> | 63.5 | <i>2.500</i> | 40.6 | <i>1.600</i> | 66.7 | <i>2.625</i> | 84.7 | <i>3.336</i> |
| TSK-445064-10-9 | 10,000 | 1 | 44.5 | <i>1.750</i> | 6.4 | <i>0.250</i> | N/A | N/A | 9.5 | <i>0.375</i> | 50.4 | <i>1.986</i> |
| TSK-445102-5-9 | 5,000 | 1 | 44.5 | <i>1.750</i> | 10.2 | <i>0.400</i> | N/A | N/A | 12.7 | <i>0.500</i> | 50.4 | <i>1.986</i> |
| TSK-445445-2-9 | 2,000 | 1 | 44.5 | <i>1.750</i> | 44.5 | <i>1.750</i> | N/A | N/A | 47.6 | <i>1.875</i> | 50.4 | <i>1.986</i> |
| TSK-508064-10-9 | 10,000 | 1 | 50.8 | <i>2.000</i> | 6.4 | <i>0.250</i> | N/A | N/A | 9.5 | <i>0.375</i> | 56.9 | <i>2.240</i> |
| TSK-508095-5-9 | 5,000 | 1 | 50.8 | <i>2.000</i> | 9.5 | <i>0.375</i> | N/A | N/A | 12.7 | <i>0.500</i> | 57.2 | <i>2.250</i> |
| TSK-508127-10-9 | 10,000 | 1 | 50.8 | <i>2.000</i> | 12.7 | <i>0.500</i> | N/A | N/A | 15.9 | <i>0.625</i> | 56.9 | <i>2.240</i> |
| TSK-508508-3-9 | 3,000 | 1 | 50.8 | <i>2.000</i> | 50.8 | <i>2.000</i> | N/A | N/A | 54.6 | <i>2.150</i> | 54.0 | <i>2.130</i> |
| TSK-523841-1.5-9 | 1,500 | 1 | 52.3 | <i>2.060</i> | 84.1 | <i>3.310</i> | N/A | N/A | 88.9 | <i>3.500</i> | 58.2 | <i>2.290</i> |

T2Y White modified polyimide film labels

Ordering information



Product dimensions

| Product order code | Package quantity | Labels across | Label width (A) | | Label height (B) | | Horizontal repeat (C) | | Vertical repeat (D) | | Web width (E) | |
|--------------------|------------------|---------------|-----------------|---------------|------------------|---------------|-----------------------|---------------|---------------------|---------------|---------------|---------------|
| | | | mm | <i>inches</i> | mm | <i>inches</i> | mm | <i>inches</i> | mm | <i>inches</i> | mm | <i>inches</i> |
| T2Y-044033-10-9 | 10,000 | 20 | 4.4 | <i>0.170</i> | 3.3 | <i>0.130</i> | 4.4 | <i>0.170</i> | 9.5 | <i>0.375</i> | 92.4 | <i>3.636</i> |
| T2Y-064064-25-9 | 25,000 | 12 | 6.4 | <i>0.250</i> | 6.4 | <i>0.250</i> | 6.4 | <i>0.250</i> | 9.5 | <i>0.375</i> | 82.2 | <i>3.240</i> |
| T2Y-076191-10-9 | 10,000 | 8 | 7.6 | <i>0.300</i> | 19.1 | <i>0.750</i> | 7.6 | <i>0.300</i> | 22.2 | <i>0.875</i> | 67.3 | <i>2.650</i> |
| T2Y-080080-10-9 | 10,000 | 8 | 8.0 | <i>0.315</i> | 8.0 | <i>0.315</i> | 9.9 | <i>0.390</i> | 13.3 | <i>0.525</i> | 83.3 | <i>3.280</i> |
| T2Y-095080-25-9 | 25,000 | 5 | 9.5 | <i>0.375</i> | 8.0 | <i>0.315</i> | 12.2 | <i>0.480</i> | 12.7 | <i>0.500</i> | 64.3 | <i>2.531</i> |
| T2Y-095095-10-9 | 10,000 | 7 | 9.5 | <i>0.375</i> | 9.5 | <i>0.375</i> | 11.1 | <i>0.437</i> | 12.7 | <i>0.500</i> | 82.1 | <i>3.230</i> |
| T2Y-127032-10-9 | 10,000 | 5 | 12.7 | <i>0.500</i> | 3.2 | <i>0.125</i> | 19.1 | <i>0.750</i> | 3.2 | <i>0.250</i> | 94.9 | <i>3.736</i> |
| T2Y-127111-10-9 | 10,000 | 5 | 12.7 | <i>0.500</i> | 11.1 | <i>0.437</i> | 16.8 | <i>0.662</i> | 14.3 | <i>0.563</i> | 86.0 | <i>3.380</i> |
| T2Y-127127-10-9 | 10,000 | 5 | 12.7 | <i>0.500</i> | 12.7 | <i>0.500</i> | 15.9 | <i>0.625</i> | 15.9 | <i>0.625</i> | 82.6 | <i>3.250</i> |
| T2Y-165051-25-9 | 25,000 | 4 | 16.5 | <i>0.650</i> | 5.1 | <i>0.200</i> | 17.8 | <i>0.700</i> | 8.3 | <i>0.325</i> | 75.8 | <i>2.990</i> |
| T2Y-171171-10-9 | 10,000 | 5 | 17.1 | <i>0.674</i> | 17.1 | <i>0.674</i> | 19.7 | <i>0.774</i> | 20.3 | <i>0.800</i> | 101.8 | <i>4.006</i> |
| T2Y-178095-10-9 | 10,000 | 4 | 17.8 | <i>0.700</i> | 9.5 | <i>0.375</i> | 19.1 | <i>0.750</i> | 12.7 | <i>0.500</i> | 80.9 | <i>3.190</i> |
| T2Y-191064-10-9 | 10,000 | 4 | 19.1 | <i>0.750</i> | 6.4 | <i>0.250</i> | 21.6 | <i>0.850</i> | 9.5 | <i>0.375</i> | 89.9 | <i>3.540</i> |
| T2Y-191762-5-9 | 5,000 | 3 | 19.1 | <i>0.750</i> | 76.2 | <i>3.000</i> | 21.6 | <i>0.850</i> | 88.9 | <i>3.500</i> | 68.2 | <i>2.686</i> |
| T2Y-229064-10-9 | 10,000 | 3 | 22.9 | <i>0.900</i> | 6.4 | <i>0.250</i> | 28.6 | <i>1.125</i> | 9.5 | <i>0.375</i> | 86.0 | <i>3.390</i> |
| T2Y-250381-10-9 | 10,000 | 4 | 24.9 | <i>0.980</i> | 38.1 | <i>1.500</i> | 27.4 | <i>1.080</i> | 47.6 | <i>1.875</i> | 113.5 | <i>4.470</i> |
| T2Y-254045-10-9 | 10,000 | 3 | 25.4 | <i>1.000</i> | 4.6 | <i>0.180</i> | 31.8 | <i>1.250</i> | 8.5 | <i>0.333</i> | 95.3 | <i>3.750</i> |
| T2Y-254064-10-9 | 10,000 | 3 | 25.4 | <i>1.000</i> | 6.4 | <i>0.250</i> | 27.9 | <i>1.100</i> | 9.5 | <i>0.375</i> | 87.3 | <i>3.436</i> |
| T2Y-254097-10-9 | 10,000 | 3 | 25.4 | <i>1.000</i> | 9.7 | <i>0.380</i> | 27.9 | <i>1.100</i> | 12.7 | <i>0.500</i> | 87.4 | <i>3.440</i> |
| T2Y-254127-10-9 | 10,000 | 3 | 25.4 | <i>1.000</i> | 12.7 | <i>0.500</i> | 27.9 | <i>1.100</i> | 16.9 | <i>0.666</i> | 87.4 | <i>3.440</i> |
| T2Y-254254-10-9 | 10,000 | 3 | 25.4 | <i>1.000</i> | 25.4 | <i>1.000</i> | 27.9 | <i>1.100</i> | 28.6 | <i>1.125</i> | 87.4 | <i>3.440</i> |
| T2Y-305047-10-9 | 10,000 | 2 | 30.5 | <i>1.200</i> | 4.7 | <i>0.185</i> | 33.0 | <i>1.300</i> | 7.8 | <i>0.306</i> | 69.5 | <i>2.736</i> |
| T2Y-318064-10-9 | 10,000 | 1 | 31.8 | <i>1.250</i> | 6.4 | <i>0.250</i> | N/A | N/A | 9.5 | <i>0.375</i> | 37.9 | <i>1.490</i> |
| T2Y-381020-10-9 | 10,000 | 1 | 38.1 | <i>1.500</i> | 2.0 | <i>0.080</i> | N/A | N/A | 10.7 | <i>0.423</i> | 44.1 | <i>1.740</i> |
| T2Y-381064-10-9 | 10,000 | 1 | 38.1 | <i>1.500</i> | 6.4 | <i>0.250</i> | N/A | N/A | 9.5 | <i>0.375</i> | 44.5 | <i>1.750</i> |
| T2Y-381127-5-9 | 5,000 | 2 | 38.1 | <i>1.500</i> | 12.7 | <i>0.500</i> | 44.2 | <i>1.738</i> | 15.9 | <i>0.625</i> | 88.2 | <i>3.472</i> |
| T2Y-381381-2.5-9 | 2,500 | 2 | 38.1 | <i>1.500</i> | 38.1 | <i>1.500</i> | 44.5 | <i>1.750</i> | 40.8 | <i>1.607</i> | 88.9 | <i>3.500</i> |
| T2Y-381635-5-9 | 5,000 | 2 | 38.1 | <i>1.500</i> | 63.5 | <i>2.500</i> | 40.6 | <i>1.600</i> | 66.7 | <i>2.625</i> | 84.7 | <i>3.336</i> |
| T2Y-445064-10-9 | 10,000 | 1 | 44.5 | <i>1.750</i> | 6.4 | <i>0.250</i> | N/A | N/A | 9.5 | <i>0.375</i> | 50.4 | <i>1.986</i> |
| T2Y-445102-5-9 | 5,000 | 1 | 44.5 | <i>1.750</i> | 10.2 | <i>0.400</i> | N/A | N/A | 12.7 | <i>0.500</i> | 50.4 | <i>1.986</i> |
| T2Y-445445-2-9 | 2,000 | 1 | 44.5 | <i>1.750</i> | 44.5 | <i>1.750</i> | N/A | N/A | 47.6 | <i>1.875</i> | 50.4 | <i>1.986</i> |
| T2Y-508064-10-9 | 10,000 | 1 | 50.8 | <i>2.000</i> | 6.4 | <i>0.250</i> | N/A | N/A | 9.5 | <i>0.375</i> | 56.9 | <i>2.240</i> |
| T2Y-508095-5-9 | 5,000 | 1 | 50.8 | <i>2.000</i> | 9.5 | <i>0.375</i> | N/A | N/A | 12.7 | <i>0.500</i> | 57.2 | <i>2.250</i> |
| T2Y-508127-10-9 | 10,000 | 1 | 50.8 | <i>2.000</i> | 12.7 | <i>0.500</i> | N/A | N/A | 15.9 | <i>0.625</i> | 56.9 | <i>2.240</i> |
| T2Y-508508-3-9 | 3,000 | 1 | 50.8 | <i>2.000</i> | 50.8 | <i>2.000</i> | N/A | N/A | 54.6 | <i>2.150</i> | 54.0 | <i>2.130</i> |
| T2Y-523841-1.5-9 | 1,500 | 1 | 52.3 | <i>2.060</i> | 84.1 | <i>3.310</i> | N/A | N/A | 88.9 | <i>3.500</i> | 58.2 | <i>2.290</i> |

Ordering information



Product dimensions

| Product order code | Package quantity | Labels across | Label width (A) | | Label height (B) | | Horizontal repeat (C) | | Vertical repeat (D) | | Web width (E) | |
|--------------------|------------------|---------------|-----------------|---------------|------------------|---------------|-----------------------|---------------|---------------------|---------------|---------------|---------------|
| | | | mm | <i>inches</i> | mm | <i>inches</i> | mm | <i>inches</i> | mm | <i>inches</i> | mm | <i>inches</i> |
| KTT-044033-10-1A | 10,000 | 20 | 0.170 | 4.4 | 0.130 | 3.3 | 0.170 | 4.4 | 0.375 | 9.5 | 3.636 | 92.4 |
| KTT-064064-25-1A | 25,000 | 12 | 0.250 | 6.4 | 0.250 | 6.4 | 0.250 | 6.4 | 0.375 | 9.5 | 3.240 | 82.2 |
| KTT-076191-10-1A | 10,000 | 8 | 0.300 | 7.6 | 0.750 | 19.1 | 0.300 | 7.6 | 0.875 | 22.2 | 2.650 | 67.3 |
| KTT-080080-10-1A | 10,000 | 8 | 0.315 | 8.0 | 0.315 | 8.0 | 0.390 | 9.9 | 0.525 | 13.3 | 3.280 | 83.3 |
| KTT-095080-25-1A | 25,000 | 5 | 0.375 | 9.5 | 0.315 | 8.0 | 0.480 | 12.2 | 0.500 | 12.7 | 2.531 | 64.3 |
| KTT-095095-10-1A | 10,000 | 7 | 0.375 | 9.5 | 0.375 | 9.5 | 0.437 | 11.1 | 0.500 | 12.7 | 3.230 | 82.1 |
| KTT-127032-10-1A | 10,000 | 5 | 0.500 | 12.7 | 0.125 | 3.2 | 0.750 | 19.1 | 0.250 | 3.2 | 3.736 | 94.9 |
| KTT-127111-10-1A | 10,000 | 5 | 0.500 | 12.7 | 0.437 | 11.1 | 0.662 | 16.8 | 0.563 | 14.3 | 3.380 | 86.0 |
| KTT-127127-10-1A | 10,000 | 5 | 0.500 | 12.7 | 0.500 | 12.7 | 0.625 | 15.9 | 0.625 | 15.9 | 3.250 | 82.6 |
| KTT-165051-25-1A | 25,000 | 4 | 0.650 | 16.5 | 0.200 | 5.1 | 0.700 | 17.8 | 0.325 | 8.3 | 2.990 | 75.8 |
| KTT-171171-10-1A | 10,000 | 5 | 0.674 | 17.1 | 0.674 | 17.1 | 0.774 | 19.7 | 0.800 | 20.3 | 4.006 | 101.8 |
| KTT-178095-10-1A | 10,000 | 4 | 0.700 | 17.8 | 0.375 | 9.5 | 0.750 | 19.1 | 0.500 | 12.7 | 3.190 | 80.9 |
| KTT-191064-10-1A | 10,000 | 4 | 0.750 | 19.1 | 0.250 | 6.4 | 0.850 | 21.6 | 0.375 | 9.5 | 3.540 | 89.9 |
| KTT-191762-5-1A | 5,000 | 3 | 0.750 | 19.1 | 3.000 | 76.2 | 0.850 | 21.6 | 3.500 | 88.9 | 2.686 | 68.2 |
| KTT-229064-10-1A | 10,000 | 3 | 0.900 | 22.9 | 0.250 | 6.4 | 1.125 | 28.6 | 0.375 | 9.5 | 3.390 | 86.0 |
| KTT-250381-10-1A | 10,000 | 4 | 0.980 | 24.9 | 1.500 | 38.1 | 1.080 | 27.4 | 1.875 | 47.6 | 4.470 | 113.5 |
| KTT-254045-10-1A | 10,000 | 3 | 1.000 | 25.4 | 0.180 | 4.6 | 1.250 | 31.8 | 0.333 | 8.5 | 3.750 | 95.3 |
| KTT-254064-10-1A | 10,000 | 3 | 1.000 | 25.4 | 0.250 | 6.4 | 1.100 | 27.9 | 0.375 | 9.5 | 3.436 | 87.3 |
| KTT-254097-10-1A | 10,000 | 3 | 1.000 | 25.4 | 0.380 | 9.7 | 1.100 | 27.9 | 0.500 | 12.7 | 3.440 | 87.4 |
| KTT-254127-10-1A | 10,000 | 3 | 1.000 | 25.4 | 0.500 | 12.7 | 1.100 | 27.9 | 0.666 | 16.9 | 3.440 | 87.4 |
| KTT-254254-10-1A | 10,000 | 3 | 1.000 | 25.4 | 1.000 | 25.4 | 1.100 | 27.9 | 1.125 | 28.6 | 3.440 | 87.4 |
| KTT-305047-10-1A | 10,000 | 2 | 1.200 | 30.5 | 0.185 | 4.7 | 1.300 | 33.0 | 0.306 | 7.8 | 2.736 | 69.5 |
| KTT-318064-10-1A | 10,000 | 1 | 1.250 | 31.8 | 0.250 | 6.4 | N/A | N/A | 0.375 | 9.5 | 1.490 | 37.9 |
| KTT-381020-10-1A | 10,000 | 1 | 1.500 | 38.1 | 0.080 | 2.0 | N/A | N/A | 0.423 | 10.7 | 1.740 | 44.1 |
| KTT-381064-10-1A | 10,000 | 1 | 1.500 | 38.1 | 0.250 | 6.4 | N/A | N/A | 0.375 | 9.5 | 1.750 | 44.5 |
| KTT-381127-5-1A | 5,000 | 2 | 1.500 | 38.1 | 0.500 | 12.7 | 1.738 | 44.2 | 0.625 | 15.9 | 3.472 | 88.2 |
| KTT-381381-2.5-1A | 2,500 | 2 | 1.500 | 38.1 | 1.500 | 38.1 | 1.750 | 44.5 | 1.607 | 40.8 | 3.500 | 88.9 |
| KTT-381635-5-1A | 5,000 | 2 | 1.500 | 38.1 | 2.500 | 63.5 | 1.600 | 40.6 | 2.625 | 66.7 | 3.336 | 84.7 |
| KTT-445064-10-1A | 10,000 | 1 | 1.750 | 44.5 | 0.250 | 6.4 | N/A | N/A | 0.375 | 9.5 | 1.986 | 50.4 |
| KTT-445102-5-1A | 5,000 | 1 | 1.750 | 44.5 | 0.400 | 10.2 | N/A | N/A | 0.500 | 12.7 | 1.986 | 50.4 |
| KTT-445445-2-1A | 2,000 | 1 | 1.750 | 44.5 | 1.750 | 44.5 | N/A | N/A | 1.875 | 47.6 | 1.986 | 50.4 |
| KTT-508064-10-1A | 10,000 | 1 | 2.000 | 50.8 | 0.250 | 6.4 | N/A | N/A | 0.375 | 9.5 | 2.240 | 56.9 |
| KTT-508095-5-1A | 5,000 | 1 | 2.000 | 50.8 | 0.375 | 9.5 | N/A | N/A | 0.500 | 12.7 | 2.250 | 57.2 |
| KTT-508127-10-1A | 10,000 | 1 | 2.000 | 50.8 | 0.500 | 12.7 | N/A | N/A | 0.625 | 15.9 | 2.240 | 56.9 |
| KTT-508508-3-1A | 3,000 | 1 | 2.000 | 50.8 | 2.000 | 50.8 | N/A | N/A | 2.150 | 54.6 | 2.130 | 54.0 |
| KTT-523841-1.5-1A | 1,500 | 1 | 2.060 | 52.3 | 3.310 | 84.1 | N/A | N/A | 3.500 | 88.9 | 2.290 | 58.2 |



PVF Polyvinylfluoride labels

Tyco PVF is a thermal transfer printable polyvinylfluoride (Tedlar®) film with a permanent acrylic adhesive, designed for wire and cable marking and other general labeling applications that require the “self-extinguishing” properties of Tedlar®. It is ideal in a variety of harsh physical and chemical environments; resists water, oil, cleaning agents and oil based solvents; and filters ultraviolet light. For guaranteed print performance and durability use with Tyco’s 3300 series ribbon.

Features and benefits

- Thermal transfer printable.
- Ideal for wire and cable marking.
- Self-extinguishing adhesive.
- Resistant to a variety of solvents.



| | |
|----------------------------|------------------------------------|
| Adhesive | Permanent acrylic |
| Service temperature | -40°C to +130°C -40°F to +266°F |
| Recommended printer | T308S* |
| Recommended ribbon | 1330-3300-10* |

*Alternative printers and ribbons are available for special applications. Contact Tyco Electronics Identification for more information.



Part numbering system



Ordering information



Product dimensions

| Product order code* | Package quantity | Labels across | Label width (A) | | Label height (B) | | Horizontal repeat (C) | | Vertical repeat (D) | | Web width (E) | |
|---------------------|------------------|---------------|-----------------|---------------|------------------|---------------|-----------------------|---------------|---------------------|---------------|---------------|---------------|
| | | | mm | <i>inches</i> | mm | <i>inches</i> | mm | <i>inches</i> | mm | <i>inches</i> | mm | <i>inches</i> |
| PVF-040040-25-9 | 25,000 | 20 | 4.0 | <i>0.157</i> | 4.0 | <i>0.157</i> | 4.0 | <i>0.157</i> | 7.2 | <i>0.281</i> | 86.0 | <i>3.380</i> |
| PVF-044033-10-9 | 10,000 | 20 | 4.4 | <i>0.170</i> | 3.3 | <i>0.130</i> | 4.4 | <i>0.170</i> | 9.5 | <i>0.375</i> | 92.4 | <i>3.636</i> |
| PVF-064064-25-9 | 25,000 | 12 | 6.4 | <i>0.250</i> | 6.4 | <i>0.250</i> | 6.4 | <i>0.250</i> | 9.5 | <i>0.375</i> | 82.2 | <i>3.240</i> |
| PVF-080080-10-9 | 10,000 | 8 | 8.0 | <i>0.315</i> | 8.0 | <i>0.315</i> | 9.9 | <i>0.390</i> | 13.3 | <i>0.525</i> | 83.3 | <i>3.280</i> |
| PVF-089047-10-9 | 10,000 | 5 | 8.9 | <i>0.350</i> | 4.7 | <i>0.185</i> | 11.4 | <i>0.450</i> | 7.9 | <i>0.313</i> | 60.6 | <i>2.386</i> |
| PVF-095080-25-9 | 25,000 | 5 | 9.5 | <i>0.375</i> | 8.0 | <i>0.315</i> | 12.2 | <i>0.480</i> | 12.7 | <i>0.500</i> | 64.3 | <i>2.531</i> |
| PVF-095095-10-9 | 10,000 | 7 | 9.5 | <i>0.375</i> | 9.5 | <i>0.375</i> | 11.1 | <i>0.437</i> | 12.7 | <i>0.500</i> | 82.1 | <i>3.230</i> |
| PVF-114040-25-9 | 25,000 | 6 | 11.4 | <i>0.450</i> | 4.0 | <i>0.157</i> | 11.4 | <i>0.450</i> | 7.2 | <i>0.281</i> | 74.6 | <i>2.940</i> |
| PVF-127032-10-9 | 10,000 | 5 | 12.7 | <i>0.500</i> | 3.2 | <i>0.125</i> | 19.1 | <i>0.750</i> | 3.2 | <i>0.250</i> | 94.9 | <i>3.736</i> |

(continued) *Replace -9 suffix with -4 for yellow labels

Product dimensions (continued)

| Product order code* | Package quantity | Labels across | Label width (A) | | Label height (B) | | Horizontal repeat (C) | | Vertical repeat (D) | | Web width (E) | |
|---------------------|------------------|---------------|-----------------|---------------|------------------|---------------|-----------------------|---------------|---------------------|---------------|---------------|---------------|
| | | | mm | <i>inches</i> | mm | <i>inches</i> | mm | <i>inches</i> | mm | <i>inches</i> | mm | <i>inches</i> |
| PVF-127111-10-9 | 10,000 | 5 | 12.7 | <i>0.500</i> | 11.1 | <i>0.437</i> | 16.8 | <i>0.662</i> | 14.3 | <i>0.563</i> | 86.0 | <i>3.380</i> |
| PVF-127127-10-9 | 10,000 | 5 | 12.7 | <i>0.500</i> | 12.7 | <i>0.500</i> | 15.9 | <i>0.625</i> | 15.9 | <i>0.625</i> | 82.6 | <i>3.250</i> |
| PVF-165051-25-9 | 25,000 | 4 | 16.5 | <i>0.650</i> | 5.1 | <i>0.200</i> | 17.8 | <i>0.700</i> | 8.3 | <i>0.325</i> | 75.8 | <i>2.990</i> |
| PVF-165102-10-9 | 10,000 | 5 | 16.5 | <i>0.650</i> | 10.2 | <i>0.400</i> | 19.1 | <i>0.750</i> | 13.8 | <i>0.545</i> | 99.1 | <i>3.900</i> |
| PVF-171171-10-9 | 10,000 | 5 | 17.1 | <i>0.674</i> | 17.1 | <i>0.674</i> | 19.7 | <i>0.774</i> | 20.3 | <i>0.800</i> | 101.8 | <i>4.006</i> |
| PVF-178095-10-9 | 10,000 | 4 | 17.8 | <i>0.700</i> | 9.5 | <i>0.375</i> | 19.1 | <i>0.750</i> | 12.7 | <i>0.500</i> | 80.9 | <i>3.190</i> |
| PVF-191064-10-9 | 10,000 | 4 | 19.1 | <i>0.750</i> | 6.4 | <i>0.250</i> | 21.6 | <i>0.850</i> | 9.5 | <i>0.375</i> | 89.9 | <i>3.540</i> |
| PVF-191114-15-9 | 15,000 | 3 | 19.1 | <i>0.750</i> | 11.4 | <i>0.450</i> | 22.2 | <i>0.875</i> | 14.7 | <i>0.579</i> | 69.5 | <i>2.736</i> |
| PVF-191762-5-9 | 5,000 | 3 | 19.1 | <i>0.750</i> | 76.2 | <i>3.000</i> | 21.6 | <i>0.850</i> | 88.9 | <i>3.500</i> | 68.2 | <i>2.686</i> |
| PVF-203127-10-9 | 10,000 | 4 | 20.3 | <i>0.800</i> | 12.7 | <i>0.500</i> | 22.9 | <i>0.900</i> | 15.9 | <i>0.625</i> | 94.6 | <i>3.730</i> |
| PVF-208086-5-9 | 5,000 | 4 | 20.8 | <i>0.820</i> | 8.6 | <i>0.340</i> | 24.1 | <i>0.950</i> | 12.7 | <i>0.500</i> | 101.6 | <i>4.000</i> |
| PVF-222159-15-9 | 15,000 | 2 | 22.2 | <i>0.875</i> | 15.9 | <i>0.625</i> | 24.8 | <i>0.975</i> | 19.1 | <i>0.750</i> | 53.0 | <i>2.086</i> |
| PVF-229064-10-9 | 10,000 | 3 | 22.9 | <i>0.900</i> | 6.4 | <i>0.250</i> | 28.6 | <i>1.125</i> | 9.5 | <i>0.375</i> | 86.0 | <i>3.390</i> |
| PVF-250381-10-9 | 10,000 | 4 | 24.9 | <i>0.980</i> | 38.1 | <i>1.500</i> | 27.4 | <i>1.080</i> | 47.6 | <i>1.875</i> | 113.5 | <i>4.470</i> |
| PVF-254045-10-9 | 10,000 | 3 | 25.4 | <i>1.000</i> | 4.6 | <i>0.180</i> | 31.8 | <i>1.250</i> | 8.5 | <i>0.333</i> | 95.3 | <i>3.750</i> |
| PVF-254064-10-9 | 10,000 | 3 | 25.4 | <i>1.000</i> | 6.4 | <i>0.250</i> | 27.9 | <i>1.100</i> | 9.5 | <i>0.375</i> | 87.3 | <i>3.436</i> |
| PVF-254097-10-9 | 10,000 | 3 | 25.4 | <i>1.000</i> | 9.7 | <i>0.380</i> | 27.9 | <i>1.100</i> | 12.7 | <i>0.500</i> | 87.4 | <i>3.440</i> |
| PVF-254127-10-9 | 10,000 | 3 | 25.4 | <i>1.000</i> | 12.7 | <i>0.500</i> | 27.9 | <i>1.100</i> | 16.9 | <i>0.666</i> | 87.4 | <i>3.440</i> |
| PVF-254254-10-9 | 10,000 | 3 | 25.4 | <i>1.000</i> | 25.4 | <i>1.000</i> | 27.9 | <i>1.100</i> | 28.6 | <i>1.125</i> | 87.4 | <i>3.440</i> |
| PVF-305047-10-9 | 10,000 | 2 | 30.5 | <i>1.200</i> | 4.7 | <i>0.185</i> | 33.0 | <i>1.300</i> | 7.8 | <i>0.306</i> | 69.5 | <i>2.736</i> |
| PVF-318064-10-9 | 10,000 | 1 | 31.8 | <i>1.250</i> | 6.4 | <i>0.250</i> | N/A | N/A | 9.5 | <i>0.375</i> | 37.9 | <i>1.490</i> |
| PVF-318097-10-9 | 10,000 | 1 | 31.8 | <i>1.250</i> | 9.7 | <i>0.380</i> | N/A | N/A | 12.7 | <i>0.500</i> | 37.8 | <i>1.488</i> |
| PVF-381020-10-9 | 10,000 | 1 | 38.1 | <i>1.500</i> | 2.0 | <i>0.080</i> | N/A | N/A | 10.7 | <i>0.423</i> | 44.1 | <i>1.740</i> |
| PVF-381064-10-9 | 10,000 | 1 | 38.1 | <i>1.500</i> | 6.4 | <i>0.250</i> | N/A | N/A | 9.5 | <i>0.375</i> | 44.5 | <i>1.750</i> |
| PVF-381127-5-9 | 5,000 | 2 | 38.1 | <i>1.500</i> | 12.7 | <i>0.500</i> | 44.2 | <i>1.738</i> | 15.9 | <i>0.625</i> | 88.2 | <i>3.472</i> |
| PVF-381191-5-9 | 5,000 | 2 | 38.1 | <i>1.500</i> | 19.1 | <i>0.750</i> | 43.2 | <i>1.700</i> | 22.2 | <i>0.875</i> | 87.6 | <i>3.450</i> |
| PVF-381381-2.5-9 | 2,500 | 2 | 38.1 | <i>1.500</i> | 38.1 | <i>1.500</i> | 44.5 | <i>1.750</i> | 40.8 | <i>1.607</i> | 88.9 | <i>3.500</i> |
| PVF-381635-5-9 | 5,000 | 2 | 38.1 | <i>1.500</i> | 63.5 | <i>2.500</i> | 40.6 | <i>1.600</i> | 66.7 | <i>2.625</i> | 84.7 | <i>3.336</i> |
| PVF-406254-1.5-9 | 1,500 | 2 | 40.6 | <i>1.600</i> | 25.4 | <i>1.000</i> | 55.9 | <i>2.200</i> | 38.1 | <i>1.500</i> | 102.9 | <i>4.050</i> |
| PVF-445064-10-9 | 10,000 | 1 | 44.5 | <i>1.750</i> | 6.4 | <i>0.250</i> | N/A | N/A | 9.5 | <i>0.375</i> | 50.4 | <i>1.986</i> |
| PVF-445102-5-9 | 5,000 | 1 | 44.5 | <i>1.750</i> | 10.2 | <i>0.400</i> | N/A | N/A | 12.7 | <i>0.500</i> | 50.4 | <i>1.986</i> |
| PVF-445445-2-9 | 2,000 | 1 | 44.5 | <i>1.750</i> | 44.5 | <i>1.750</i> | N/A | N/A | 47.6 | <i>1.875</i> | 50.4 | <i>1.986</i> |
| PVF-478175-5-9 | 5,000 | 1 | 47.8 | <i>1.880</i> | 17.5 | <i>0.690</i> | N/A | N/A | 24.4 | <i>0.962</i> | 66.0 | <i>2.600</i> |
| PVF-508064-10-9 | 10,000 | 1 | 50.8 | <i>2.000</i> | 6.4 | <i>0.250</i> | N/A | N/A | 9.5 | <i>0.375</i> | 56.9 | <i>2.240</i> |
| PVF-508095-5-9 | 5,000 | 1 | 50.8 | <i>2.000</i> | 9.5 | <i>0.375</i> | N/A | N/A | 12.7 | <i>0.500</i> | 57.2 | <i>2.250</i> |
| PVF-508127-10-9 | 10,000 | 1 | 50.8 | <i>2.000</i> | 12.7 | <i>0.500</i> | N/A | N/A | 15.9 | <i>0.625</i> | 56.9 | <i>2.240</i> |
| PVF-508254-5-9 | 5,000 | 1 | 50.8 | <i>2.000</i> | 25.4 | <i>1.000</i> | N/A | N/A | 28.6 | <i>1.125</i> | 57.2 | <i>2.250</i> |
| PVF-508318-2.5-9 | 2,500 | 1 | 50.8 | <i>2.000</i> | 31.8 | <i>1.250</i> | N/A | N/A | 34.9 | <i>1.375</i> | 56.9 | <i>2.240</i> |
| PVF-508508-3-9 | 3,000 | 1 | 50.8 | <i>2.000</i> | 50.8 | <i>2.000</i> | N/A | N/A | 54.6 | <i>2.150</i> | 54.0 | <i>2.130</i> |
| PVF-523841-1.5-9 | 1,500 | 1 | 52.3 | <i>2.060</i> | 84.1 | <i>3.310</i> | N/A | N/A | 88.9 | <i>3.500</i> | 58.2 | <i>2.290</i> |
| PVF-610419-2.5-9 | 2,500 | 1 | 61.0 | <i>2.400</i> | 41.9 | <i>1.650</i> | N/A | N/A | 45.5 | <i>1.792</i> | 67.3 | <i>2.650</i> |
| PVF-699191-5-9 | 5,000 | 1 | 69.9 | <i>2.750</i> | 19.1 | <i>0.750</i> | N/A | N/A | 23.3 | <i>0.917</i> | 76.2 | <i>3.000</i> |
| PVF-699254-5-9 | 5,000 | 1 | 69.9 | <i>2.750</i> | 25.4 | <i>1.000</i> | N/A | N/A | 28.6 | <i>1.125</i> | 76.2 | <i>3.000</i> |
| PVF-762381-2.5-9 | 2,500 | 1 | 76.2 | <i>3.000</i> | 38.1 | <i>1.500</i> | N/A | N/A | 41.3 | <i>1.625</i> | 82.3 | <i>3.240</i> |
| PVF-762508-2.5-9 | 2,500 | 1 | 76.2 | <i>3.000</i> | 50.8 | <i>2.000</i> | N/A | N/A | 54.0 | <i>2.125</i> | 82.6 | <i>3.240</i> |
| PVF-762127-1-9 | 1,000 | 1 | 76.2 | <i>3.000</i> | 127.0 | <i>5.000</i> | N/A | N/A | 129.5 | <i>5.100</i> | 79.4 | <i>3.130</i> |
| PVF-101508-2.5-9 | 2,500 | 1 | 101.6 | <i>4.000</i> | 50.8 | <i>2.000</i> | N/A | N/A | 54.6 | <i>2.150</i> | 104.1 | <i>4.100</i> |
| PVF-101635-2.5-9 | 2,500 | 1 | 101.6 | <i>4.000</i> | 63.5 | <i>2.500</i> | N/A | N/A | 66.7 | <i>2.625</i> | 107.7 | <i>4.240</i> |
| PVF-101762-1.8-9 | 1,800 | 1 | 101.6 | <i>4.000</i> | 76.2 | <i>3.000</i> | N/A | N/A | 79.4 | <i>3.125</i> | 104.1 | <i>4.100</i> |
| PVF-101101-1.3-9 | 1,300 | 1 | 101.6 | <i>4.000</i> | 101.6 | <i>4.000</i> | N/A | N/A | 104.8 | <i>4.125</i> | 104.1 | <i>4.100</i> |
| PVF-101165-0.85-9 | 850 | 1 | 101.6 | <i>4.000</i> | 165.1 | <i>6.500</i> | N/A | N/A | 168.3 | <i>6.680</i> | 104.9 | <i>4.130</i> |

*Replace -9 suffix with -4 for yellow labels



Electronics

Thermal Transfer

EP Economy paper labels

Tyco EP is a thermal transfer printable paper with a permanent adhesive, designed for use in general purpose labeling applications requiring a low cost label material. EP has an aggressive adhesive for bonding to corrugated, films and plastic materials, and it is ideal for labeling in mild environments. The ultra-smooth finish is excellent for bar coding applications. EP remains bonded permanently to most surfaces and typically results in label or substrate tear when removal is attempted. For guaranteed print performance use with Tyco's RS series ribbon.

Features and benefits

- Thermal transfer printable.
- Ultra-smooth coated facstock.
- Versatile adhesive with excellent initial tack.
- Several die-cut sizes available.



| | | |
|----------------------------|------------------------|-----------------|
| Adhesive | Permanent rubber-based | |
| Service temperature | -54°C to +66°C | -65°F to +150°F |
| Recommended printer | T308S* | |
| Recommended ribbon | 1330-0600-10* | |

*Alternative printers and ribbons are available for special applications. Contact Tyco Electronics Identification for more information.

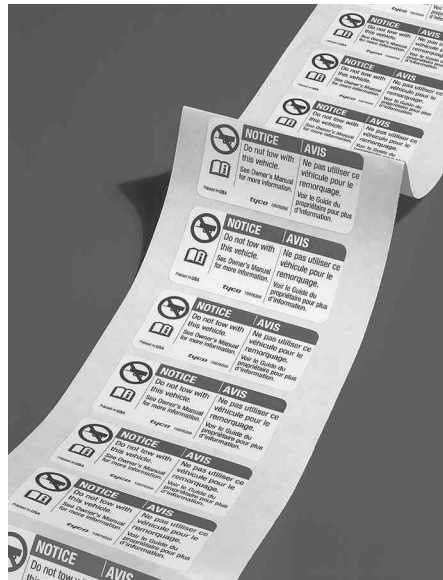

Part numbering system

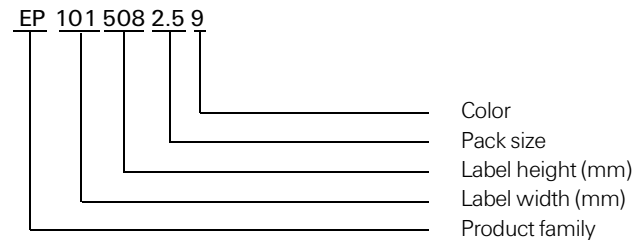

Ordering information

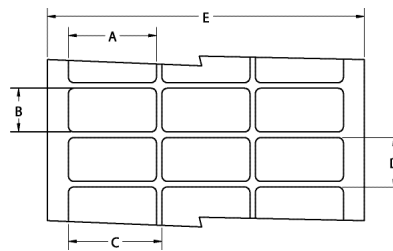

Product dimensions

| Product order code | Package quantity | Labels across | Label width (A) | | Label height (B) | | Horizontal repeat (C) | | Vertical repeat (D) | | Web width (E) | |
|--------------------|------------------|---------------|-----------------|---------------|------------------|---------------|-----------------------|---------------|---------------------|---------------|---------------|---------------|
| | | | mm | <i>inches</i> | mm | <i>inches</i> | mm | <i>inches</i> | mm | <i>inches</i> | mm | <i>inches</i> |
| EP-040040-25-9 | 25,000 | 20 | 4.0 | <i>0.157</i> | 4.0 | <i>0.157</i> | 4.0 | <i>0.157</i> | 7.2 | <i>0.281</i> | 86.0 | <i>3.380</i> |
| EP-044033-10-9 | 10,000 | 20 | 4.4 | <i>0.170</i> | 3.3 | <i>0.130</i> | 4.4 | <i>0.170</i> | 9.5 | <i>0.375</i> | 92.4 | <i>3.636</i> |
| EP-064064-25-9 | 25,000 | 12 | 6.4 | <i>0.250</i> | 6.4 | <i>0.250</i> | 6.4 | <i>0.250</i> | 9.5 | <i>0.375</i> | 82.2 | <i>3.240</i> |
| EP-080080-10-9 | 10,000 | 8 | 8.0 | <i>0.315</i> | 8.0 | <i>0.315</i> | 9.9 | <i>0.390</i> | 13.3 | <i>0.525</i> | 83.3 | <i>3.280</i> |
| EP-089047-10-9 | 10,000 | 5 | 8.9 | <i>0.350</i> | 4.7 | <i>0.185</i> | 11.4 | <i>0.450</i> | 7.9 | <i>0.313</i> | 60.6 | <i>2.386</i> |
| EP-095080-25-9 | 25,000 | 5 | 9.5 | <i>0.375</i> | 8.0 | <i>0.315</i> | 12.2 | <i>0.480</i> | 12.7 | <i>0.500</i> | 64.3 | <i>2.531</i> |
| EP-095095-10-9 | 10,000 | 7 | 9.5 | <i>0.375</i> | 9.5 | <i>0.375</i> | 11.1 | <i>0.437</i> | 12.7 | <i>0.500</i> | 82.1 | <i>3.230</i> |
| EP-114040-25-9 | 25,000 | 6 | 11.4 | <i>0.450</i> | 4.0 | <i>0.157</i> | 11.4 | <i>0.450</i> | 7.2 | <i>0.281</i> | 74.6 | <i>2.940</i> |
| EP-127032-10-9 | 10,000 | 5 | 12.7 | <i>0.500</i> | 3.2 | <i>0.125</i> | 19.1 | <i>0.750</i> | 3.2 | <i>0.250</i> | 94.9 | <i>3.736</i> |

(continued)

Catalog 1654227
Revised 01-04

www.tycoelectronics.com

Dimensions not italicized are in millimeters while dimensions in inches are italicized.

Dimensions are shown for reference purposes only. Specifications subject to change.

USA: 1-800-522-6752
Canada: 1-905-470-4425
Mexico: 01-800-733-8926
C. America: 52-55-5-729-0425

South America: 55-11-3611-1514
Hong Kong: 852-2735-1628
Japan: 81-44-844-8013
UK: 44-141-810-8967

Product dimensions (continued)

| Product order code | Package quantity | Labels across | Label width (A) | | Label height (B) | | Horizontal repeat (C) | | Vertical repeat (D) | | Web width (E) | |
|--------------------|------------------|---------------|-----------------|---------------|------------------|---------------|-----------------------|---------------|---------------------|---------------|---------------|---------------|
| | | | mm | <i>inches</i> | mm | <i>inches</i> | mm | <i>inches</i> | mm | <i>inches</i> | mm | <i>inches</i> |
| EP-127111-10-9 | 10,000 | 5 | 12.7 | <i>0.500</i> | 11.1 | <i>0.437</i> | 16.8 | <i>0.662</i> | 14.3 | <i>0.563</i> | 86.0 | <i>3.380</i> |
| EP-127127-10-9 | 10,000 | 5 | 12.7 | <i>0.500</i> | 12.7 | <i>0.500</i> | 15.9 | <i>0.625</i> | 15.9 | <i>0.625</i> | 82.6 | <i>3.250</i> |
| EP-165051-25-9 | 25,000 | 4 | 16.5 | <i>0.650</i> | 5.1 | <i>0.200</i> | 17.8 | <i>0.700</i> | 8.3 | <i>0.325</i> | 75.8 | <i>2.990</i> |
| EP-165102-10-9 | 10,000 | 5 | 16.5 | <i>0.650</i> | 10.2 | <i>0.400</i> | 19.1 | <i>0.750</i> | 13.8 | <i>0.545</i> | 99.1 | <i>3.900</i> |
| EP-171171-10-9 | 10,000 | 5 | 17.1 | <i>0.674</i> | 17.1 | <i>0.674</i> | 19.7 | <i>0.774</i> | 20.3 | <i>0.800</i> | 101.8 | <i>4.006</i> |
| EP-178095-10-9 | 10,000 | 4 | 17.8 | <i>0.700</i> | 9.5 | <i>0.375</i> | 19.1 | <i>0.750</i> | 12.7 | <i>0.500</i> | 80.9 | <i>3.190</i> |
| EP-191064-10-9 | 10,000 | 4 | 19.1 | <i>0.750</i> | 6.4 | <i>0.250</i> | 21.6 | <i>0.850</i> | 9.5 | <i>0.375</i> | 89.9 | <i>3.540</i> |
| EP-191114-15-9 | 15,000 | 3 | 19.1 | <i>0.750</i> | 11.4 | <i>0.450</i> | 22.2 | <i>0.875</i> | 14.7 | <i>0.579</i> | 69.5 | <i>2.736</i> |
| EP-191762-5-9 | 5,000 | 3 | 19.1 | <i>0.750</i> | 76.2 | <i>3.000</i> | 21.6 | <i>0.850</i> | 88.9 | <i>3.500</i> | 68.2 | <i>2.686</i> |
| EP-203127-10-9 | 10,000 | 4 | 20.3 | <i>0.800</i> | 12.7 | <i>0.500</i> | 22.9 | <i>0.900</i> | 15.9 | <i>0.625</i> | 94.6 | <i>3.730</i> |
| EP-208086-5-9 | 5,000 | 4 | 20.8 | <i>0.820</i> | 8.6 | <i>0.340</i> | 24.1 | <i>0.950</i> | 12.7 | <i>0.500</i> | 101.6 | <i>4.000</i> |
| EP-222159-15-9 | 15,000 | 2 | 22.2 | <i>0.875</i> | 15.9 | <i>0.625</i> | 24.8 | <i>0.975</i> | 19.1 | <i>0.750</i> | 53.0 | <i>2.086</i> |
| EP-229064-10-9 | 10,000 | 3 | 22.9 | <i>0.900</i> | 6.4 | <i>0.250</i> | 28.6 | <i>1.125</i> | 9.5 | <i>0.375</i> | 86.0 | <i>3.390</i> |
| EP-250381-10-9 | 10,000 | 4 | 24.9 | <i>0.980</i> | 38.1 | <i>1.500</i> | 27.4 | <i>1.080</i> | 47.6 | <i>1.875</i> | 113.5 | <i>4.470</i> |
| EP-254045-10-9 | 10,000 | 3 | 25.4 | <i>1.000</i> | 4.6 | <i>0.180</i> | 31.8 | <i>1.250</i> | 8.5 | <i>0.333</i> | 95.3 | <i>3.750</i> |
| EP-254064-10-9 | 10,000 | 3 | 25.4 | <i>1.000</i> | 6.4 | <i>0.250</i> | 27.9 | <i>1.100</i> | 9.5 | <i>0.375</i> | 87.3 | <i>3.436</i> |
| EP-254097-10-9 | 10,000 | 3 | 25.4 | <i>1.000</i> | 9.7 | <i>0.380</i> | 27.9 | <i>1.100</i> | 12.7 | <i>0.500</i> | 87.4 | <i>3.440</i> |
| EP-254127-10-9 | 10,000 | 3 | 25.4 | <i>1.000</i> | 12.7 | <i>0.500</i> | 27.9 | <i>1.100</i> | 16.9 | <i>0.666</i> | 87.4 | <i>3.440</i> |
| EP-254254-10-9 | 10,000 | 3 | 25.4 | <i>1.000</i> | 25.4 | <i>1.000</i> | 27.9 | <i>1.100</i> | 28.6 | <i>1.125</i> | 87.4 | <i>3.440</i> |
| EP-305047-10-9 | 10,000 | 2 | 30.5 | <i>1.200</i> | 4.7 | <i>0.185</i> | 33.0 | <i>1.300</i> | 7.8 | <i>0.306</i> | 69.5 | <i>2.736</i> |
| EP-318064-10-9 | 10,000 | 1 | 31.8 | <i>1.250</i> | 6.4 | <i>0.250</i> | N/A | N/A | 9.5 | <i>0.375</i> | 37.9 | <i>1.490</i> |
| EP-318097-10-9 | 10,000 | 1 | 31.8 | <i>1.250</i> | 9.7 | <i>0.380</i> | N/A | N/A | 12.7 | <i>0.500</i> | 37.8 | <i>1.488</i> |
| EP-381020-10-9 | 10,000 | 1 | 38.1 | <i>1.500</i> | 2.0 | <i>0.080</i> | N/A | N/A | 10.7 | <i>0.423</i> | 44.1 | <i>1.740</i> |
| EP-381064-10-9 | 10,000 | 1 | 38.1 | <i>1.500</i> | 6.4 | <i>0.250</i> | N/A | N/A | 9.5 | <i>0.375</i> | 44.5 | <i>1.750</i> |
| EP-381127-5-9 | 5,000 | 2 | 38.1 | <i>1.500</i> | 12.7 | <i>0.500</i> | 44.2 | <i>1.738</i> | 15.9 | <i>0.625</i> | 88.2 | <i>3.472</i> |
| EP-381191-5-9 | 5,000 | 2 | 38.1 | <i>1.500</i> | 19.1 | <i>0.750</i> | 43.2 | <i>1.700</i> | 22.2 | <i>0.875</i> | 87.6 | <i>3.450</i> |
| EP-381381-2.5-9 | 2,500 | 2 | 38.1 | <i>1.500</i> | 38.1 | <i>1.500</i> | 44.5 | <i>1.750</i> | 40.8 | <i>1.607</i> | 88.9 | <i>3.500</i> |
| EP-381635-5-9 | 5,000 | 2 | 38.1 | <i>1.500</i> | 63.5 | <i>2.500</i> | 40.6 | <i>1.600</i> | 66.7 | <i>2.625</i> | 84.7 | <i>3.336</i> |
| EP-406254-1.5-9 | 1,500 | 2 | 40.6 | <i>1.600</i> | 25.4 | <i>1.000</i> | 55.9 | <i>2.200</i> | 38.1 | <i>1.500</i> | 102.9 | <i>4.050</i> |
| EP-445064-10-9 | 10,000 | 1 | 44.5 | <i>1.750</i> | 6.4 | <i>0.250</i> | N/A | N/A | 9.5 | <i>0.375</i> | 50.4 | <i>1.986</i> |
| EP-445102-5-9 | 5,000 | 1 | 44.5 | <i>1.750</i> | 10.2 | <i>0.400</i> | N/A | N/A | 12.7 | <i>0.500</i> | 50.4 | <i>1.986</i> |
| EP-445445-2-9 | 2,000 | 1 | 44.5 | <i>1.750</i> | 44.5 | <i>1.750</i> | N/A | N/A | 47.6 | <i>1.875</i> | 50.4 | <i>1.986</i> |
| EP-478175-5-9 | 5,000 | 1 | 47.8 | <i>1.880</i> | 17.5 | <i>0.690</i> | N/A | N/A | 24.4 | <i>0.962</i> | 66.0 | <i>2.600</i> |
| EP-508064-10-9 | 10,000 | 1 | 50.8 | <i>2.000</i> | 6.4 | <i>0.250</i> | N/A | N/A | 9.5 | <i>0.375</i> | 56.9 | <i>2.240</i> |
| EP-508095-5-9 | 5,000 | 1 | 50.8 | <i>2.000</i> | 9.5 | <i>0.375</i> | N/A | N/A | 12.7 | <i>0.500</i> | 57.2 | <i>2.250</i> |
| EP-508127-10-9 | 10,000 | 1 | 50.8 | <i>2.000</i> | 12.7 | <i>0.500</i> | N/A | N/A | 15.9 | <i>0.625</i> | 56.9 | <i>2.240</i> |
| EP-508254-5-9 | 5,000 | 1 | 50.8 | <i>2.000</i> | 25.4 | <i>1.000</i> | N/A | N/A | 28.6 | <i>1.125</i> | 57.2 | <i>2.250</i> |
| EP-508318-2.5-9 | 2,500 | 1 | 50.8 | <i>2.000</i> | 31.8 | <i>1.250</i> | N/A | N/A | 34.9 | <i>1.375</i> | 56.9 | <i>2.240</i> |
| EP-508508-3-9 | 3,000 | 1 | 50.8 | <i>2.000</i> | 50.8 | <i>2.000</i> | N/A | N/A | 54.6 | <i>2.150</i> | 54.0 | <i>2.130</i> |
| EP-523841-1.5-9 | 1,500 | 1 | 52.3 | <i>2.060</i> | 84.1 | <i>3.310</i> | N/A | N/A | 88.9 | <i>3.500</i> | 58.2 | <i>2.290</i> |
| EP-610419-2.5-9 | 2,500 | 1 | 61.0 | <i>2.400</i> | 41.9 | <i>1.650</i> | N/A | N/A | 45.5 | <i>1.792</i> | 67.3 | <i>2.650</i> |
| EP-699191-5-9 | 5,000 | 1 | 69.9 | <i>2.750</i> | 19.1 | <i>0.750</i> | N/A | N/A | 23.3 | <i>0.917</i> | 76.2 | <i>3.000</i> |
| EP-699254-5-9 | 5,000 | 1 | 69.9 | <i>2.750</i> | 25.4 | <i>1.000</i> | N/A | N/A | 28.6 | <i>1.125</i> | 76.2 | <i>3.000</i> |
| EP-762381-2.5-9 | 2,500 | 1 | 76.2 | <i>3.000</i> | 38.1 | <i>1.500</i> | N/A | N/A | 41.3 | <i>1.625</i> | 82.3 | <i>3.240</i> |
| EP-762508-2.5-9 | 2,500 | 1 | 76.2 | <i>3.000</i> | 50.8 | <i>2.000</i> | N/A | N/A | 54.0 | <i>2.125</i> | 82.6 | <i>3.240</i> |
| EP-762127-1-9 | 1,000 | 1 | 76.2 | <i>3.000</i> | 127.0 | <i>5.000</i> | N/A | N/A | 129.5 | <i>5.100</i> | 79.4 | <i>3.130</i> |
| EP-101508-2.5-9 | 2,500 | 1 | 101.6 | <i>4.000</i> | 50.8 | <i>2.000</i> | N/A | N/A | 54.6 | <i>2.150</i> | 104.1 | <i>4.100</i> |
| EP-101635-2.5-9 | 2,500 | 1 | 101.6 | <i>4.000</i> | 63.5 | <i>2.500</i> | N/A | N/A | 66.7 | <i>2.625</i> | 107.7 | <i>4.240</i> |
| EP-101762-1.8-9 | 1,800 | 1 | 101.6 | <i>4.000</i> | 76.2 | <i>3.000</i> | N/A | N/A | 79.4 | <i>3.125</i> | 104.1 | <i>4.100</i> |
| EP-101101-1.3-9 | 1,300 | 1 | 101.6 | <i>4.000</i> | 101.6 | <i>4.000</i> | N/A | N/A | 104.8 | <i>4.125</i> | 104.1 | <i>4.100</i> |
| EP-101165-0.85-9 | 850 | 1 | 101.6 | <i>4.000</i> | 165.1 | <i>6.500</i> | N/A | N/A | 168.3 | <i>6.680</i> | 104.9 | <i>4.130</i> |

C Vinyl cloth labels

Tyco C is a dot matrix printable vinyl coated cloth material with a permanent acrylic adhesive that is designed for application to irregular surfaces where conformability is required. It is ideal for permanent wire marking, or it can be flagged onto wires for temporary marking. C is also ideal for electronic component identification and other general purpose labeling applications. For guaranteed print performance and durability, use with Tyco's RI Quick-Dry series ribbon.

Features and benefits

- Flexible, easily conforms to curved surfaces.
- Dot matrix printable.
- Several die-cut sizes available.
- Excellent abrasion resistance.
- Resistant to oil, water and several common fluids.



| | | |
|----------------------------|--|-----------------|
| Adhesive | Permanent acrylic | |
| Service temperature | -29°C to +80°C | -20°F to +176°F |
| Recommended printer | LQ870* | |
| Recommended ribbon | 1330-0037-00* | |
| | <i>*Alternative printers and ribbons are available for special applications. Contact Tyco Electronics Identification for more information.</i> | |

Part numbering system

C-064064-10-9



C Vinyl cloth labels

Ordering information



Product dimensions

| Product order code | Package quantity | Labels across | Label width (A) | | Label height (B) | | Horizontal repeat (C) | | Vertical repeat (D) | | Web width (E) | |
|--------------------|------------------|---------------|-----------------|---------------|------------------|---------------|-----------------------|---------------|---------------------|---------------|---------------|---------------|
| | | | mm | <i>inches</i> | mm | <i>inches</i> | mm | <i>inches</i> | mm | <i>inches</i> | mm | <i>inches</i> |
| C-064064-10-9 | 10,000 | 20 | 6.4 | <i>0.250</i> | 6.4 | <i>0.250</i> | 6.4 | <i>0.250</i> | 8.5 | <i>0.333</i> | 152.4 | <i>6.000</i> |
| C-076191-10-9 | 10,000 | 16 | 7.6 | <i>0.300</i> | 19.1 | <i>0.750</i> | 7.6 | <i>0.300</i> | 25.4 | <i>1.000</i> | 147.3 | <i>5.800</i> |
| C-080080-10-9 | 10,000 | 10 | 8.0 | <i>0.315</i> | 8.0 | <i>0.315</i> | 8.0 | <i>0.315</i> | 12.7 | <i>0.500</i> | 105.4 | <i>4.150</i> |
| C-095095-10-9 | 10,000 | 16 | 9.5 | <i>0.375</i> | 9.5 | <i>0.375</i> | 12.7 | <i>0.500</i> | 12.7 | <i>0.500</i> | 226.1 | <i>8.900</i> |
| C-115064-10-9 | 10,000 | 8 | 11.5 | <i>0.450</i> | 6.4 | <i>0.250</i> | 14.0 | <i>0.550</i> | 9.5 | <i>0.375</i> | 134.6 | <i>5.300</i> |
| C-121064-10-9 | 10,000 | 8 | 12.1 | <i>0.475</i> | 6.4 | <i>0.250</i> | 14.6 | <i>0.575</i> | 8.5 | <i>0.333</i> | 139.7 | <i>5.500</i> |
| C-154064-10-9 | 10,000 | 7 | 15.4 | <i>0.600</i> | 6.4 | <i>0.250</i> | 17.8 | <i>0.700</i> | 8.5 | <i>0.333</i> | 147.3 | <i>5.800</i> |
| C-159079-10-9 | 10,000 | 8 | 15.9 | <i>0.625</i> | 7.9 | <i>0.310</i> | 19.1 | <i>0.750</i> | 12.7 | <i>0.500</i> | 174.6 | <i>6.875</i> |
| C-165051-10-9 | 10,000 | 10 | 16.5 | <i>0.650</i> | 5.1 | <i>0.200</i> | 20.3 | <i>0.800</i> | 6.4 | <i>0.250</i> | 224.8 | <i>8.850</i> |
| C-191064-10-9 | 10,000 | 9 | 19.1 | <i>0.750</i> | 6.4 | <i>0.250</i> | 22.9 | <i>0.900</i> | 8.5 | <i>0.333</i> | 227.3 | <i>8.950</i> |
| C-203127-10-9 | 10,000 | 10 | 20.3 | <i>0.800</i> | 12.7 | <i>0.500</i> | 20.3 | <i>0.800</i> | 15.9 | <i>0.625</i> | 228.6 | <i>9.000</i> |
| C-203365-10-9 | 10,000 | 6 | 20.3 | <i>0.800</i> | 36.5 | <i>1.437</i> | 22.9 | <i>0.900</i> | 38.1 | <i>1.500</i> | 160.0 | <i>6.300</i> |
| C-215055-10-9 | 10,000 | 5 | 21.5 | <i>0.846</i> | 5.5 | <i>0.217</i> | 25.4 | <i>1.000</i> | 8.5 | <i>0.333</i> | 148.6 | <i>5.850</i> |
| C-229064-10-9 | 10,000 | 8 | 22.9 | <i>0.900</i> | 6.4 | <i>0.250</i> | 25.4 | <i>1.000</i> | 8.5 | <i>0.333</i> | 226.1 | <i>8.900</i> |
| C-254095-10-9 | 10,000 | 7 | 25.4 | <i>1.000</i> | 9.5 | <i>0.375</i> | 27.9 | <i>1.100</i> | 12.7 | <i>0.500</i> | 218.4 | <i>8.600</i> |
| C-254127-10-9 | 10,000 | 7 | 25.4 | <i>1.000</i> | 12.7 | <i>0.500</i> | 27.9 | <i>1.100</i> | 16.9 | <i>0.666</i> | 218.4 | <i>8.600</i> |
| C-293064-10-9 | 10,000 | 4 | 29.3 | <i>1.150</i> | 6.4 | <i>0.250</i> | 9.4 | <i>0.370</i> | 30.5 | <i>1.200</i> | 146.1 | <i>5.750</i> |
| C-381064-10-S1-9 | 10,000 | 4* | 38.1 | <i>1.500</i> | 6.4 | <i>0.250</i> | 45.7 | <i>1.800</i> | 8.5 | <i>0.333</i> | 200.7 | <i>7.900</i> |
| C-394064-10-9 | 10,000 | 4 | 39.4 | <i>1.550</i> | 6.4 | <i>0.250</i> | 41.9 | <i>1.650</i> | 8.5 | <i>0.333</i> | 190.5 | <i>7.500</i> |
| C-508095-5-9 | 5,000 | 3 | 50.8 | <i>2.000</i> | 9.5 | <i>0.375</i> | 53.3 | <i>2.100</i> | 12.7 | <i>0.500</i> | 182.9 | <i>7.200</i> |
| C-533064-5-9 | 5,000 | 3 | 53.3 | <i>2.100</i> | 6.4 | <i>0.250</i> | 55.9 | <i>2.200</i> | 8.5 | <i>0.333</i> | 190.5 | <i>7.500</i> |
| C-533114-5-9 | 5,000 | 3 | 53.3 | <i>2.100</i> | 11.4 | <i>0.450</i> | 55.9 | <i>2.200</i> | 14.7 | <i>0.579</i> | 190.5 | <i>7.500</i> |

*Perforated

M Metalized polyester labels

Tyco M is a dot matrix printable metalized polyester film with a permanent acrylic adhesive that is designed for rating plate applications and other applications that require a "metal look" such as nameplates, rating plates and equipment labels to detail product information and serial numbers. M is UL Listed and CSA Certified, and its print performance and durability are guaranteed when used with Tyco's RI Quick-Dry series ribbon.

Features and benefits

- Dot matrix printable.
- Exceptional durability and strength.
- Matte finish ink receptive coating for better contrast.
- Resistant to oil, water and several common fluids.
- UL Listed and CSA Certified.

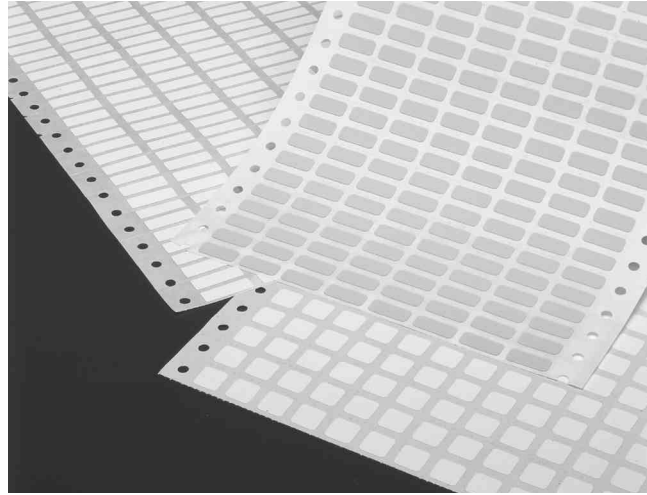

| | |
|----------------------------|-----------------------------------|
| Adhesive | Permanent acrylic |
| Service temperature | -53°C to +93°C -65°F to +200°F |
| Recommended printer | LQ870* |
| Recommended ribbon | 1330-0037-00* |

*Alternative printers and ribbons are available for special applications. Contact Tyco Electronics Identification for more information.

Part numbering system

M-064064-10-8A



M Metalized polyester labels (Cont'd)

Ordering information



Product dimensions

| Product order code | Package quantity | Labels across | Label width (A) | | Label height (B) | | Horizontal repeat (C) | | Vertical repeat (D) | | Web width (E) | |
|--------------------|------------------|---------------|-----------------|---------------|------------------|---------------|-----------------------|---------------|---------------------|---------------|---------------|---------------|
| | | | mm | <i>inches</i> | mm | <i>inches</i> | mm | <i>inches</i> | mm | <i>inches</i> | mm | <i>inches</i> |
| M-064064-10-8A | 10,000 | 20 | 6.4 | <i>0.250</i> | 6.4 | <i>0.250</i> | 6.4 | <i>0.250</i> | 8.5 | <i>0.333</i> | 152.4 | <i>6.000</i> |
| M-076191-10-8A | 10,000 | 16 | 7.6 | <i>0.300</i> | 19.1 | <i>0.750</i> | 7.6 | <i>0.300</i> | 25.4 | <i>1.000</i> | 147.3 | <i>5.800</i> |
| M-080080-10-8A | 10,000 | 10 | 8.0 | <i>0.315</i> | 8.0 | <i>0.315</i> | 8.0 | <i>0.315</i> | 12.7 | <i>0.500</i> | 105.4 | <i>4.150</i> |
| M-095095-10-8A | 10,000 | 16 | 9.5 | <i>0.375</i> | 9.5 | <i>0.375</i> | 12.7 | <i>0.500</i> | 12.7 | <i>0.500</i> | 226.1 | <i>8.900</i> |
| M-102070-10-8A | 10,000 | 4 | 10.2 | <i>0.400</i> | 7.0 | <i>0.275</i> | 15.9 | <i>0.625</i> | 9.5 | <i>0.375</i> | 83.2 | <i>3.275</i> |
| M-115064-10-8A | 10,000 | 8 | 11.5 | <i>0.450</i> | 6.4 | <i>0.250</i> | 14.0 | <i>0.550</i> | 9.5 | <i>0.375</i> | 134.6 | <i>5.300</i> |
| M-121064-10-8A | 10,000 | 8 | 12.1 | <i>0.475</i> | 6.4 | <i>0.250</i> | 14.6 | <i>0.575</i> | 8.5 | <i>0.333</i> | 139.7 | <i>5.500</i> |
| M-127111-10-8A | 10,000 | 13 | 12.7 | <i>0.500</i> | 11.1 | <i>0.437</i> | 15.2 | <i>0.600</i> | 15.9 | <i>0.625</i> | 221.0 | <i>8.700</i> |
| M-127191-10-8A | 10,000 | 12 | 12.7 | <i>0.500</i> | 19.1 | <i>0.750</i> | 15.2 | <i>0.600</i> | 25.4 | <i>1.000</i> | 205.7 | <i>8.100</i> |
| M-154064-10-8A | 10,000 | 7 | 15.4 | <i>0.600</i> | 6.4 | <i>0.250</i> | 17.8 | <i>0.700</i> | 8.5 | <i>0.333</i> | 147.3 | <i>5.800</i> |
| M-159079-10-8A | 10,000 | 8 | 15.9 | <i>0.625</i> | 7.9 | <i>0.310</i> | 19.1 | <i>0.750</i> | 12.7 | <i>0.500</i> | 174.6 | <i>6.875</i> |
| M-165051-10-8A | 10,000 | 10 | 16.5 | <i>0.650</i> | 5.1 | <i>0.200</i> | 20.3 | <i>0.800</i> | 6.4 | <i>0.250</i> | 224.8 | <i>8.850</i> |
| M-191064-10-8A | 10,000 | 9 | 19.1 | <i>0.750</i> | 6.4 | <i>0.250</i> | 22.9 | <i>0.900</i> | 8.5 | <i>0.333</i> | 227.3 | <i>8.950</i> |
| M-203064-10-8A | 10,000 | 10 | 20.3 | <i>0.800</i> | 6.4 | <i>0.250</i> | 20.3 | <i>0.800</i> | 8.5 | <i>0.333</i> | 228.6 | <i>9.000</i> |
| M-203127-10-8A | 10,000 | 10 | 20.3 | <i>0.800</i> | 12.7 | <i>0.500</i> | 20.3 | <i>0.800</i> | 15.9 | <i>0.625</i> | 228.6 | <i>9.000</i> |
| M-203365-10-8A | 10,000 | 6 | 20.3 | <i>0.800</i> | 36.5 | <i>1.437</i> | 22.9 | <i>0.900</i> | 38.1 | <i>1.500</i> | 160.0 | <i>6.300</i> |
| M-215055-10-8A | 10,000 | 5 | 21.5 | <i>0.846</i> | 5.5 | <i>0.217</i> | 25.4 | <i>1.000</i> | 8.5 | <i>0.333</i> | 148.6 | <i>5.850</i> |
| M-229064-10-8A | 10,000 | 8 | 22.9 | <i>0.900</i> | 6.4 | <i>0.250</i> | 25.4 | <i>1.000</i> | 8.5 | <i>0.333</i> | 226.1 | <i>8.900</i> |
| M-254095-10-8A | 10,000 | 7 | 25.4 | <i>1.000</i> | 9.5 | <i>0.375</i> | 27.9 | <i>1.100</i> | 12.7 | <i>0.500</i> | 218.4 | <i>8.600</i> |
| M-254127-10-8A | 10,000 | 7 | 25.4 | <i>1.000</i> | 12.7 | <i>0.500</i> | 27.9 | <i>1.100</i> | 16.9 | <i>0.666</i> | 218.4 | <i>8.600</i> |
| M-293064-10-8A | 10,000 | 4 | 29.3 | <i>1.150</i> | 6.4 | <i>0.250</i> | 9.4 | <i>0.370</i> | 30.5 | <i>1.200</i> | 146.1 | <i>5.750</i> |
| M-381191-10-8A | 10,000 | 4 | 38.1 | <i>1.500</i> | 19.1 | <i>0.750</i> | 43.2 | <i>1.700</i> | 25.4 | <i>1.000</i> | 193.0 | <i>7.600</i> |
| M-394064-10-8A | 10,000 | 4 | 39.4 | <i>1.550</i> | 6.4 | <i>0.250</i> | 41.9 | <i>1.650</i> | 8.5 | <i>0.333</i> | 190.5 | <i>7.500</i> |
| M-508095-5-8A | 5,000 | 3 | 50.8 | <i>2.000</i> | 9.5 | <i>0.375</i> | 53.3 | <i>2.100</i> | 12.7 | <i>0.500</i> | 182.9 | <i>7.200</i> |
| M-508254-4-8A | 4,000 | 4 | 50.8 | <i>2.000</i> | 25.4 | <i>1.075</i> | 50.8 | <i>2.000</i> | 28.6 | <i>1.125</i> | 228.6 | <i>9.000</i> |
| M-508318-3-8A | 3,000 | 4 | 50.8 | <i>2.000</i> | 31.8 | <i>1.250</i> | 50.8 | <i>2.000</i> | 34.9 | <i>1.375</i> | 228.6 | <i>9.000</i> |
| M-533064-5-8A | 5,000 | 3 | 53.3 | <i>2.100</i> | 6.4 | <i>0.250</i> | 55.9 | <i>2.200</i> | 8.5 | <i>0.333</i> | 190.5 | <i>7.500</i> |
| M-533114-5-8A | 5,000 | 3 | 53.3 | <i>2.100</i> | 11.4 | <i>0.450</i> | 55.9 | <i>2.200</i> | 14.7 | <i>0.579</i> | 190.5 | <i>7.500</i> |
| M-572286-2.5-8A | 2,500 | 1 | 57.2 | <i>2.250</i> | 28.6 | <i>1.130</i> | N/A | N/A | 31.8 | <i>1.250</i> | 82.6 | <i>3.250</i> |
| M-673254-3-8A | 3,000 | 3 | 67.3 | <i>2.650</i> | 25.4 | <i>1.000</i> | 67.3 | <i>2.650</i> | 38.1 | <i>1.500</i> | 227.3 | <i>8.950</i> |
| M-673349-3-8A | 3,000 | 3 | 67.3 | <i>2.650</i> | 34.9 | <i>1.375</i> | 67.3 | <i>2.650</i> | 38.1 | <i>1.500</i> | 227.3 | <i>8.950</i> |
| M-699254-2.5-8A | 2,500 | 3 | 69.9 | <i>2.750</i> | 25.4 | <i>1.000</i> | 73.0 | <i>2.875</i> | 28.6 | <i>1.125</i> | 241.3 | <i>9.500</i> |
| M-699318-2.5-8A | 2,500 | 3 | 69.9 | <i>2.750</i> | 31.8 | <i>1.250</i> | 73.0 | <i>2.875</i> | 34.9 | <i>1.375</i> | 241.3 | <i>9.500</i> |
| M-711064-5-8A | 5,000 | 1 | 71.1 | <i>2.800</i> | 6.4 | <i>0.250</i> | N/A | N/A | 8.5 | <i>0.333</i> | 96.5 | <i>3.800</i> |
| M-762508-1-8A | 1,000 | 2 | 76.2 | <i>3.000</i> | 50.8 | <i>2.000</i> | 79.4 | <i>3.125</i> | 54.0 | <i>2.125</i> | 181.0 | <i>7.130</i> |
| M-920254-2.5-8A | 2,500 | 2 | 92.0 | <i>3.620</i> | 25.4 | <i>1.000</i> | 94.6 | <i>3.725</i> | 28.6 | <i>1.125</i> | 212.1 | <i>8.350</i> |
| M-920381-2.5-8A | 2,500 | 2 | 92.0 | <i>3.620</i> | 38.1 | <i>1.500</i> | 95.3 | <i>3.750</i> | 41.3 | <i>1.625</i> | 212.8 | <i>8.380</i> |
| M-165101-1-8A | 1,000 | 1 | 165.1 | <i>6.500</i> | 101.6 | <i>4.000</i> | N/A | N/A | 108.0 | <i>4.250</i> | 190.5 | <i>7.500</i> |



Electronics

Dot Matrix

K Kapton® labels

Tyco K is a dot matrix printable, 2 mil thick tan polyimide (Kapton®) with a permanent acrylic adhesive that is ideal for high temperature labeling requirements such as printed circuit boards. It is suitable for direct wave (bottom side) and IR reflow (top side) PCB applications, and is designed to withstand the fluxes, cleaning solvents and molten solder encountered in the manufacture of printed circuit boards. With a flash exposure service temperature of +538°C (+1000°F), K is suitable for the harshest high temperature applications. For guaranteed print performance and durability, use with Tyco's RI Quick-Dry series ribbon.



Features and benefits

- Dot matrix printable.
- Matte finish for better print contrast.
- Product approved for aerospace/defense applications.
- Exceptional durability and tear resistance.
- High temperature permanent acrylic adhesive.
- Superior solvent and UV resistance.
- Low outgassing.



| | |
|---|---|
| Adhesive | Permanent acrylic |
| Service temperature* | -40°C to +260°C -40°F to +500°F *Flash exposure to +538°C (+1000°F) |
| Recommended printer | LQ870** |
| Recommended ribbon | 1330-0037-00** |
| <small>**Alternative printers and ribbons are available for special applications. Contact Tyco Electronics Identification for more information.</small> | |

Part numbering system

K-064064-10-1A



Ordering information



Product dimensions

| Product order code | Package quantity | Labels across | Label width (A) | | Label height (B) | | Horizontal repeat (C) | | Vertical repeat (D) | | Web width (E) | |
|--------------------|------------------|---------------|-----------------|---------------|------------------|---------------|-----------------------|---------------|---------------------|---------------|---------------|---------------|
| | | | mm | <i>inches</i> | mm | <i>inches</i> | mm | <i>inches</i> | mm | <i>inches</i> | mm | <i>inches</i> |
| K-064064-10-1A | 10,000 | 20 | 6.4 | <i>0.250</i> | 6.4 | <i>0.250</i> | 6.4 | <i>0.250</i> | 8.5 | <i>0.333</i> | 152.4 | <i>6.000</i> |
| K-076191-10-1A | 10,000 | 16 | 7.6 | <i>0.300</i> | 19.1 | <i>0.750</i> | 7.6 | <i>0.300</i> | 25.4 | <i>1.000</i> | 147.3 | <i>5.800</i> |
| K-080080-10-1A | 10,000 | 10 | 8.0 | <i>0.315</i> | 8.0 | <i>0.315</i> | 8.0 | <i>0.315</i> | 12.7 | <i>0.500</i> | 105.4 | <i>4.150</i> |
| K-095095-10-1A | 10,000 | 16 | 9.5 | <i>0.375</i> | 9.5 | <i>0.375</i> | 12.7 | <i>0.500</i> | 12.7 | <i>0.500</i> | 226.1 | <i>8.900</i> |
| K-115064-10-1A | 10,000 | 8 | 11.5 | <i>0.450</i> | 6.4 | <i>0.250</i> | 14.0 | <i>0.550</i> | 9.5 | <i>0.375</i> | 134.6 | <i>5.300</i> |
| K-121064-10-1A | 10,000 | 8 | 12.1 | <i>0.475</i> | 6.4 | <i>0.250</i> | 14.6 | <i>0.575</i> | 8.5 | <i>0.333</i> | 139.7 | <i>5.500</i> |
| K-154064-10-1A | 10,000 | 7 | 15.4 | <i>0.600</i> | 6.4 | <i>0.250</i> | 17.8 | <i>0.700</i> | 8.5 | <i>0.333</i> | 147.3 | <i>5.800</i> |
| K-159079-10-1A | 10,000 | 8 | 15.9 | <i>0.625</i> | 7.9 | <i>0.310</i> | 19.1 | <i>0.750</i> | 12.7 | <i>0.500</i> | 174.6 | <i>6.875</i> |
| K-165051-10-1A | 10,000 | 10 | 16.5 | <i>0.650</i> | 5.1 | <i>0.200</i> | 20.3 | <i>0.800</i> | 6.4 | <i>0.250</i> | 224.8 | <i>8.850</i> |
| K-191064-10-1A | 10,000 | 9 | 19.1 | <i>0.750</i> | 6.4 | <i>0.250</i> | 22.9 | <i>0.900</i> | 8.5 | <i>0.333</i> | 227.3 | <i>8.950</i> |
| K-203127-10-1A | 10,000 | 10 | 20.3 | <i>0.800</i> | 12.7 | <i>0.500</i> | 20.3 | <i>0.800</i> | 15.9 | <i>0.625</i> | 228.6 | <i>9.000</i> |
| K-203365-10-1A | 10,000 | 6 | 20.3 | <i>0.800</i> | 36.5 | <i>1.437</i> | 22.9 | <i>0.900</i> | 38.1 | <i>1.500</i> | 160.0 | <i>6.300</i> |
| K-215055-10-1A | 10,000 | 5 | 21.5 | <i>0.846</i> | 5.5 | <i>0.217</i> | 25.4 | <i>1.000</i> | 8.5 | <i>0.333</i> | 148.6 | <i>5.850</i> |
| K-229064-10-1A | 10,000 | 8 | 22.9 | <i>0.900</i> | 6.4 | <i>0.250</i> | 25.4 | <i>1.000</i> | 8.5 | <i>0.333</i> | 226.1 | <i>8.900</i> |
| K-254095-10-1A | 10,000 | 7 | 25.4 | <i>1.000</i> | 9.5 | <i>0.375</i> | 27.9 | <i>1.100</i> | 12.7 | <i>0.500</i> | 218.4 | <i>8.600</i> |
| K-254127-10-1A | 10,000 | 7 | 25.4 | <i>1.000</i> | 12.7 | <i>0.500</i> | 27.9 | <i>1.100</i> | 16.9 | <i>0.666</i> | 218.4 | <i>8.600</i> |
| K-293064-10-1A | 10,000 | 4 | 29.3 | <i>1.150</i> | 6.4 | <i>0.250</i> | 9.4 | <i>0.370</i> | 30.5 | <i>1.200</i> | 146.1 | <i>5.750</i> |
| K-508095-5-1A | 5,000 | 3 | 50.8 | <i>2.000</i> | 9.5 | <i>0.375</i> | 53.3 | <i>2.100</i> | 12.7 | <i>0.500</i> | 182.9 | <i>7.200</i> |
| K-533064-5-1A | 5,000 | 3 | 53.3 | <i>2.100</i> | 6.4 | <i>0.250</i> | 55.9 | <i>2.200</i> | 8.5 | <i>0.333</i> | 190.5 | <i>7.500</i> |



Electronics

Dot Matrix

E White polyester labels

Tyco E is a dot matrix printable white polyester film with a permanent acrylic adhesive that is ideal for PCB and component labeling, as well as general purpose labeling applications that require a high durability white label. It is resistant to a variety of solvents while maintaining print quality. E is UL Listed and CSA Certified, and its print performance and durability are guaranteed when used with Tyco's RI Quick-Dry series ribbon.



Features and benefits

- Dot matrix printable.
- Cost-efficient for general purpose, low volume applications.
- Exceptional durability and strength.
- Resistant to oil, water and several common fluids.
- UL Listed and CSA Certified.



| | |
|--|-----------------------------------|
| Adhesive | Permanent acrylic |
| Service temperature | -53°C to +93°C -65°F to +200°F |
| Recommended printer | LQ870* |
| Recommended ribbon | 1330-0037-00* |
| <small>*Alternative printers and ribbons are available for special applications. Contact Tyco Electronics Identification for more information.</small> | |

Part numbering system

E-064064-10-9

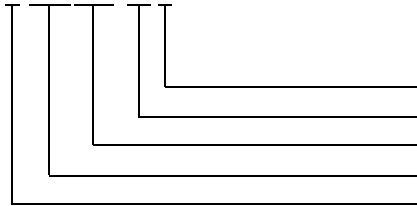

- Color
- Pack size
- Label height (mm)
- Label width (mm)
- Product family

E White polyester labels (Cont'd)

Ordering information



Product dimensions

| Product order code | Package quantity | Labels across | Label width (A) mm <i>inches</i> | Label height (B) mm <i>inches</i> | Horizontal repeat (C) mm <i>inches</i> | Vertical repeat (D) mm <i>inches</i> | Web width (E) mm <i>inches</i> |
|--------------------|------------------|---------------|--|---|--|--|--------------------------------------|
| E-064064-10-9 | 10,000 | 20 | 6.4 <i>0.250</i> | 6.4 <i>0.250</i> | 6.4 <i>0.250</i> | 8.5 <i>0.333</i> | 152.4 <i>6.000</i> |
| E-076191-10-9 | 10,000 | 16 | 7.6 <i>0.300</i> | 19.1 <i>0.750</i> | 7.6 <i>0.300</i> | 25.4 <i>1.000</i> | 147.3 <i>5.800</i> |
| E-080080-10-9 | 10,000 | 10 | 8.0 <i>0.315</i> | 8.0 <i>0.315</i> | 8.0 <i>0.315</i> | 12.7 <i>0.500</i> | 105.4 <i>4.150</i> |
| E-095095-10-9 | 10,000 | 16 | 9.5 <i>0.375</i> | 9.5 <i>0.375</i> | 12.7 <i>0.500</i> | 12.7 <i>0.500</i> | 226.1 <i>8.900</i> |
| E-102070-10-9 | 10,000 | 4 | 10.2 <i>0.400</i> | 7.0 <i>0.275</i> | 15.9 <i>0.625</i> | 9.5 <i>0.375</i> | 83.2 <i>3.275</i> |
| E-115064-10-9 | 10,000 | 8 | 11.5 <i>0.450</i> | 6.4 <i>0.250</i> | 14.0 <i>0.550</i> | 9.5 <i>0.375</i> | 134.6 <i>5.300</i> |
| E-121064-10-9 | 10,000 | 8 | 12.1 <i>0.475</i> | 6.4 <i>0.250</i> | 14.6 <i>0.575</i> | 8.5 <i>0.333</i> | 139.7 <i>5.500</i> |
| E-127111-10-9 | 10,000 | 13 | 12.7 <i>0.500</i> | 11.1 <i>0.437</i> | 15.2 <i>0.600</i> | 15.9 <i>0.625</i> | 221 <i>8.700</i> |
| E-127191-10-9 | 10,000 | 12 | 12.7 <i>0.500</i> | 19.1 <i>0.750</i> | 15.2 <i>0.600</i> | 25.4 <i>1.000</i> | 205.7 <i>8.100</i> |
| E-154064-10-9 | 10,000 | 7 | 15.4 <i>0.600</i> | 6.4 <i>0.250</i> | 17.8 <i>0.700</i> | 8.5 <i>0.333</i> | 147.3 <i>5.800</i> |
| E-159079-10-9 | 10,000 | 8 | 15.9 <i>0.625</i> | 7.9 <i>0.310</i> | 19.1 <i>0.750</i> | 12.7 <i>0.500</i> | 174.6 <i>6.875</i> |
| E-165051-10-9 | 10,000 | 10 | 16.5 <i>0.650</i> | 5.1 <i>0.200</i> | 20.3 <i>0.800</i> | 6.4 <i>0.250</i> | 224.8 <i>8.850</i> |
| E-191064-10-9 | 10,000 | 9 | 19.1 <i>0.750</i> | 6.4 <i>0.250</i> | 22.9 <i>0.900</i> | 8.5 <i>0.333</i> | 227.3 <i>8.950</i> |
| E-203064-10-9 | 10,000 | 10 | 20.3 <i>0.800</i> | 6.4 <i>0.250</i> | 20.3 <i>0.800</i> | 8.5 <i>0.333</i> | 228.6 <i>9.000</i> |
| E-203127-10-9 | 10,000 | 10 | 20.3 <i>0.800</i> | 12.7 <i>0.500</i> | 20.3 <i>0.800</i> | 15.9 <i>0.625</i> | 228.6 <i>9.000</i> |
| E-203365-10-9 | 10,000 | 6 | 20.3 <i>0.800</i> | 36.5 <i>1.437</i> | 22.9 <i>0.900</i> | 38.1 <i>1.500</i> | 160.0 <i>6.300</i> |
| E-215055-10-9 | 10,000 | 5 | 21.5 <i>0.846</i> | 5.5 <i>0.217</i> | 25.4 <i>1.000</i> | 8.5 <i>0.333</i> | 148.6 <i>5.850</i> |
| E-229064-10-9 | 10,000 | 8 | 22.9 <i>0.900</i> | 6.4 <i>0.250</i> | 25.4 <i>1.000</i> | 8.5 <i>0.333</i> | 226.1 <i>8.900</i> |
| E-254095-10-9 | 10,000 | 7 | 25.4 <i>1.000</i> | 9.5 <i>0.375</i> | 27.9 <i>1.100</i> | 12.7 <i>0.500</i> | 218.4 <i>8.600</i> |
| E-254127-10-9 | 10,000 | 7 | 25.4 <i>1.000</i> | 12.7 <i>0.500</i> | 27.9 <i>1.100</i> | 16.9 <i>0.666</i> | 218.4 <i>8.600</i> |
| E-293064-10-9 | 10,000 | 4 | 29.3 <i>1.150</i> | 6.4 <i>0.250</i> | 9.4 <i>0.370</i> | 30.5 <i>1.200</i> | 146.1 <i>5.750</i> |
| E-381191-10-9 | 10,000 | 4 | 38.1 <i>1.500</i> | 19.1 <i>0.750</i> | 43.2 <i>1.700</i> | 25.4 <i>1.000</i> | 193.0 <i>7.600</i> |
| E-394064-10-9 | 10,000 | 4 | 39.4 <i>1.550</i> | 6.4 <i>0.250</i> | 41.9 <i>1.650</i> | 8.5 <i>0.333</i> | 190.5 <i>7.500</i> |
| E-508095-5-9 | 5,000 | 3 | 50.8 <i>2.000</i> | 9.5 <i>0.375</i> | 53.3 <i>2.100</i> | 12.7 <i>0.500</i> | 182.9 <i>7.200</i> |
| E-508254-4-9 | 4,000 | 4 | 50.8 <i>2.000</i> | 25.4 <i>1.000</i> | 50.8 <i>2.000</i> | 28.6 <i>1.125</i> | 228.6 <i>9.000</i> |
| E-508318-3-9 | 3,000 | 4 | 50.8 <i>2.000</i> | 31.8 <i>1.250</i> | 50.8 <i>2.000</i> | 34.9 <i>1.375</i> | 228.6 <i>9.000</i> |
| E-533064-5-9 | 5,000 | 3 | 53.3 <i>2.100</i> | 6.4 <i>0.250</i> | 55.9 <i>2.200</i> | 8.5 <i>0.333</i> | 190.5 <i>7.500</i> |
| E-533114-5-9 | 5,000 | 3 | 53.3 <i>2.100</i> | 11.4 <i>0.450</i> | 55.9 <i>2.200</i> | 14.7 <i>0.579</i> | 190.5 <i>7.500</i> |
| E-572286-2-5-9 | 2,500 | 1 | 57.2 <i>2.250</i> | 28.6 <i>1.125</i> | N/A N/A | 31.8 <i>1.250</i> | 82.6 <i>3.250</i> |
| E-673254-3-9 | 3,000 | 3 | 67.3 <i>2.650</i> | 25.4 <i>1.000</i> | 67.3 <i>2.650</i> | 38.1 <i>1.500</i> | 227.3 <i>8.950</i> |
| E-673349-3-9 | 3,000 | 3 | 67.3 <i>2.650</i> | 34.9 <i>1.375</i> | 67.3 <i>2.650</i> | 38.1 <i>1.500</i> | 227.3 <i>8.950</i> |
| E-699254-2-5-9 | 2,500 | 3 | 69.9 <i>2.750</i> | 25.4 <i>1.000</i> | 73.0 <i>2.875</i> | 28.6 <i>1.125</i> | 241.3 <i>9.500</i> |
| E-699318-2-5-9 | 2,500 | 3 | 69.9 <i>2.750</i> | 31.8 <i>1.250</i> | 73.0 <i>2.875</i> | 34.9 <i>1.375</i> | 241.3 <i>9.500</i> |
| E-711064-5-9 | 5,000 | 1 | 71.1 <i>2.800</i> | 6.4 <i>0.250</i> | N/A N/A | 8.5 <i>0.333</i> | 96.5 <i>3.800</i> |
| E-762508-1-9 | 1,000 | 2 | 76.2 <i>3.000</i> | 50.8 <i>2.000</i> | 79.4 <i>3.125</i> | 54.0 <i>2.125</i> | 181.0 <i>7.130</i> |
| E-920254-2-5-9 | 2,500 | 2 | 92.0 <i>3.620</i> | 25.4 <i>1.000</i> | 94.6 <i>3.725</i> | 28.6 <i>1.125</i> | 212.1 <i>8.350</i> |
| E-920381-2-5-9 | 2,500 | 2 | 92.0 <i>3.620</i> | 38.1 <i>1.500</i> | 95.3 <i>3.750</i> | 41.3 <i>1.625</i> | 212.8 <i>8.380</i> |
| E-165101-1-9 | 1,000 | 1 | 165.1 <i>6.500</i> | 101.6 <i>4.000</i> | N/A N/A | 108.0 <i>4.250</i> | 190.5 <i>7.500</i> |



Electronics

Laser

LE/LM/LEB2 Polyester Labels

LE

Tyco LE is a white polyester film with a permanent acrylic adhesive and a special top-coat designed specifically for use with laser and ink jet printers. It is ideal for bar coding, PCB and component labeling, and general labeling applications requiring a white high durability label. LE offers high print resolution as well as good solvent and smudge resistance.

LM

Tyco LM is a metalized polyester film with a permanent acrylic adhesive and a special top-coat designed specifically for use with laser and ink jet printers. It is ideal for rating plate applications and other applications that require a "metal look" such as nameplates and equipment labels to detail product information and serial numbers.

Note: On large label formats, some curl may occur on printing due to duration of time in the laser printer.

LEB2

LEB2, our A4 size symmetrically-designed laser and ink jet labels, guarantee a proper feeding in the paper tray. The label sheet can be used in both directions and is also usable for the stack function of your printer. The sheets can be used several times if partial label amounts need to be printed. Special surface coatings guarantee an extremely high aging-resistance of the printing image.

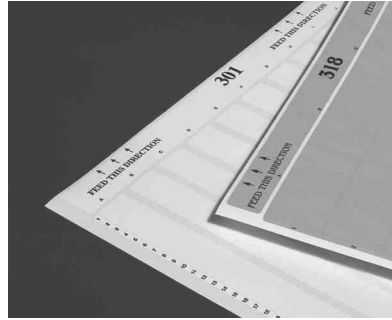

Features and benefits

- Laser printable.
- Exceptional durability and tear strength.
- Suitable for low volume applications.
- Excellent for bar code applications.
- Good resistance to common fluids and water.
- LM metalized appearance is ideal for rating plate applications.
- LEB2 features symmetrical design – can be printed on from both top sides.



| | |
|----------------------------|------------------------------------|
| Adhesive | Permanent acrylic |
| Service temperature | -40°C to +150°C -40°F to +302°F |

Ordering information



Ordering information (continued)

LE

| Product order code | Package quantity | Labels across | Labels per sheet | Label width (A) | | Label height (B) | | Horizontal repeat (C) | | Vertical repeat (D) | |
|--------------------|------------------|---------------|------------------|-----------------|--------|------------------|--------|-----------------------|--------|---------------------|--------|
| | | | | mm | inches | mm | inches | mm | inches | mm | inches |
| 314-LE | 4,000 | 16 | 400 | 9.5 | 0.375 | 9.5 | 0.375 | 12.7 | 0.500 | 9.5 | 0.375 |
| 301-LE | 4,800 | 10 | 480 | 16.5 | 0.650 | 5.1 | 0.200 | 20.3 | 0.800 | 5.1 | 0.200 |
| 303-LE | 3,040 | 8 | 304 | 20.3 | 0.800 | 6.4 | 0.250 | 25.4 | 1.000 | 6.4 | 0.250 |
| 304-LE | 1,520 | 8 | 152 | 20.3 | 0.800 | 12.7 | 0.500 | 25.4 | 1.000 | 12.7 | 0.500 |
| 309-LE | 2,660 | 7 | 266 | 25.4 | 1.000 | 6.4 | 0.250 | 27.9 | 1.100 | 6.4 | 0.250 |
| 305-LE | 1,750 | 7 | 175 | 25.4 | 1.000 | 9.5 | 0.375 | 27.9 | 1.100 | 9.5 | 0.375 |
| 307-LE | 1,330 | 7 | 133 | 25.4 | 1.000 | 12.7 | 0.500 | 27.9 | 1.100 | 12.7 | 0.500 |
| 310-LE | 1,900 | 5 | 190 | 38.1 | 1.500 | 6.4 | 0.250 | 40.6 | 1.600 | 6.4 | 0.250 |
| 308-LE | 600 | 5 | 60 | 38.1 | 1.500 | 19.1 | 0.750 | 40.6 | 1.600 | 19.1 | 0.750 |
| 318-LE | 400 | 4 | 40 | 50.8 | 2.000 | 25.4 | 1.000 | 50.8 | 2.000 | 25.4 | 1.000 |
| 319-LE | 100 | 2 | 10 | 76.2 | 3.000 | 50.8 | 2.000 | 88.9 | 3.500 | 50.8 | 2.000 |
| 325-LE | 10 | 1 | 1 | 215.9 | 8.500 | 279.4 | 11.000 | N/A | N/A | N/A | N/A |

LM

| Product order code | Package quantity | Labels across | Labels per sheet | Label width (A) | | Label height (B) | | Horizontal repeat (C) | | Vertical repeat (D) | |
|--------------------|------------------|---------------|------------------|-----------------|--------|------------------|--------|-----------------------|--------|---------------------|--------|
| | | | | mm | inches | mm | inches | mm | inches | mm | inches |
| 314-LM | 4,000 | 16 | 400 | 9.5 | 0.375 | 9.5 | 0.375 | 12.7 | 0.500 | 9.5 | 0.375 |
| 301-LM | 4,800 | 10 | 480 | 16.5 | 0.650 | 5.1 | 0.200 | 20.3 | 0.800 | 5.1 | 0.200 |
| 303-LM | 3,040 | 8 | 304 | 20.3 | 0.800 | 6.4 | 0.250 | 25.4 | 1.000 | 6.4 | 0.250 |
| 304-LM | 1,520 | 8 | 152 | 20.3 | 0.800 | 12.7 | 0.500 | 25.4 | 1.000 | 12.7 | 0.500 |
| 309-LM | 2,660 | 7 | 266 | 25.4 | 1.000 | 6.4 | 0.250 | 27.9 | 1.100 | 6.4 | 0.250 |
| 305-LM | 1,750 | 7 | 175 | 25.4 | 1.000 | 9.5 | 0.375 | 27.9 | 1.100 | 9.5 | 0.375 |
| 307-LM | 1,330 | 7 | 133 | 25.4 | 1.000 | 12.7 | 0.500 | 27.9 | 1.100 | 12.7 | 0.500 |
| 310-LM | 1,900 | 5 | 190 | 38.1 | 1.500 | 6.4 | 0.250 | 40.6 | 1.600 | 6.4 | 0.250 |
| 308-LM | 600 | 5 | 60 | 38.1 | 1.500 | 19.1 | 0.750 | 40.6 | 1.600 | 19.1 | 0.750 |
| 318-LM | 400 | 4 | 40 | 50.8 | 2.000 | 25.4 | 1.000 | 50.8 | 2.000 | 25.4 | 1.000 |
| 319-LM | 100 | 2 | 10 | 76.2 | 3.000 | 50.8 | 2.000 | 88.9 | 3.500 | 50.8 | 2.000 |
| 325-LM | 10 | 1 | 1 | 215.9 | 8.500 | 279.4 | 11.000 | N/A | N/A | N/A | N/A |

LEB2

| Product order code | Labels per sheet | Label height | | Label width | | Labels per column | Labels per row |
|--------------------|------------------|--------------|--------|-------------|--------|-------------------|----------------|
| | | mm | inches | mm | inches | | |
| LEB2-0615P <color> | 480 | 6.0 | 0.236 | 15.0 | 0.590 | 48 | 10 |
| LEB2-0818P <color> | 324 | 8.0 | 0.315 | 18.0 | 0.709 | 36 | 9 |
| LEB2-0820P <color> | 288 | 8.0 | 0.315 | 20.0 | 0.787 | 36 | 8 |
| LEB2-0825P <color> | 252 | 8.0 | 0.315 | 25.0 | 0.984 | 36 | 7 |
| LEB2-0916P <color> | 320 | 9.0 | 0.354 | 16.0 | 0.630 | 32 | 10 |
| LEB2-0920P <color> | 256 | 9.0 | 0.354 | 20.0 | 0.787 | 32 | 8 |
| LEB2-1318P <color> | 198 | 13.0 | 0.512 | 18.0 | 0.709 | 22 | 9 |
| LEB2-1325P <color> | 154 | 13.0 | 0.512 | 25.0 | 0.984 | 22 | 7 |

Sheet sizes

| | |
|--------|------------|
| LE, LM | 8.5" x 11" |
| LEB2 | A4 |

Options (LEB2 only)

| | | | |
|--------|--------|-------|--------|
| Colors | Yellow | White | Silver |
| Code | G | W | S |

PRINTERS

| | |
|-------------------------------------|-----|
| T200 Series Printers | 107 |
| T300 Series Printers | 108 |
| T400 Series Printers | 109 |
| T6 12M-DS Printer | 110 |
| AM6310 Printer | 111 |
| LQ870 Printer | 112 |
| LMS-9000 Laser Marking System | 113 |



RIBBONS

| | |
|------------------------|-----|
| Thermal Transfer | 114 |
| Dot Matrix | 120 |



SOFTWARE

| | |
|-----------------|-----|
| WinTotal | 122 |
| PrintEasy | 124 |

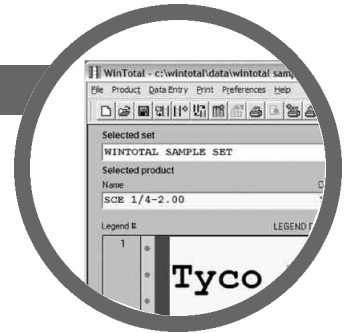

APPLICATION SYSTEMS

| | |
|-------------------|-----|
| Hot Air Gun | 126 |
|-------------------|-----|



T200 Series Portable thermal transfer printers

The T200 Series of printers are portable/desktop thermal transfer printers with a 4.1" print head offering an economical option for low volume customers who want to take advantage of thermal transfer printing technology. Their small, light weight design makes them ideal for applications requiring portability or in environments with multiple workstations where space is limited.

The T208M has a 200 dpi print head; the T2 12M has a 300 dpi print head for crisp, high quality text, bar codes and graphic images. Both printers are designed for use with Tyco's range of TMS heat shrinkable wire marker sleeves and limited thermal transfer printable pressure sensitive label products.



Printer specifications

| | |
|-------------------------|---|
| Print head width | 104 mm (4.09") |
| Print head resolution | T208M: 8 dpmm (203 dpi) T2 12M: 12 dpmm (305 dpi) |
| Print speed (maximum) | 51 mm per second (2 inches per second) |
| Media sensor | Transmissive – fixed |
| Memory | T208M: 256 KB SRAM and 512 KB flash T2 12M: 512 KB SRAM and 1 MB flash |
| Communication interface | Parallel (centronics) and serial (RS232) |
| Printer dimensions | 200 mm W x 247 mm D x 171 mm H (7.9" W x 9.75" D x 6.75" H) |
| Printer weight | 1.81 kg (4 lbs) |

Media specifications

| | |
|-----------------------------|----------------|
| Maximum print width | 104 mm (4.09") |
| Maximum media width | 118 mm (4.65") |
| Minimum media width | 28 mm (1.12") |
| Maximum media roll diameter | 127 mm (5.0") |
| Media core diameter | 25 mm (1.0") |
| Ribbon wind | Ink side out |

Product order code

Description

| | |
|------------------|---|
| T208M-PRINTER | Tyco T208M thermal printer – standard |
| T208M-C-PRINTER | Tyco T208M thermal printer – cutter option |
| T2 12M-PRINTER | Tyco T2 12M thermal printer – standard |
| T2 12M-C-PRINTER | Tyco T2 12M thermal printer – cutter option |

tyco**Electronics**

Printers

T300 Series High performance, cost effective thermal transfer printers

Tyco's T300 Series of printers are high performance, yet cost effective thermal transfer printers with a 4.1" print head. The rugged and durable all metal construction makes them suitable for demanding industrial and commercial environments. The enhanced memory and 32 bit processor provide fast data processing and print speeds. Optional accessories are available for added convenience and efficiency.

The T308S and T308S-N have a 200 dpi print head for use with the Tyco range of thermal transfer printable pressure sensitive label products. The T308S-N provides network capability for real time connectivity with the printer. With such connectivity, print jobs can be modified from any location over the Internet via Web-based tools. The T308S-N printer is also capable of sending alerts via e-mail enabled wired or wireless devices.

The 300 dpi print head on the T312S and T312M produces crisp, high quality text, bar codes and graphic images. The T312S is for use with Tyco thermal transfer printable pressure sensitive label products. The T312M is designed for use with Tyco TMS and H.S.I. wire marker sleeves, as well as thermal transfer printable pressure sensitive label products.

**Printer specifications**

| | |
|-------------------------|--|
| Print head width | 104 mm (4.09") |
| Print head resolution | T308S: 8 dpmm (203 dpi) T312M/T312S: 12 dpmm (305 dpi) |
| Print speed (maximum) | 203 mm per second (8 inches per second) |
| Media sensor | Transmissive – adjustable |
| Memory | 3 MB DRAM and 750 KB flash T308S-N: Additional 8 MB flash memory in PCMCIA socket |
| Communication interface | Bi-directional parallel port and RS232C/422/485 serial port |
| Printer dimensions | 283 mm W x 495 mm D x 394 mm H (11.2" W x 19.5" D x 15.5" H) |
| Printer weight | 25 kg (55 lbs) |

Media specifications

| | |
|-----------------------------|----------------|
| Maximum print width | 104 mm (4.09") |
| Maximum media width | 115 mm (4.52") |
| Minimum media width | 20 mm (0.79") |
| Maximum media roll diameter | 203 mm (8.0") |
| Media core diameter | 76 mm (3.0") |
| Ribbon wind | Ink side out |

Product order code

| Product order code | Description |
|--------------------|---|
| T308S-PRINTER | Tyco T308S thermal printer – standard |
| T308S-C-PRINTER | Tyco T308S thermal printer – cutter option |
| T308S-R-PRINTER | Tyco T308S thermal printer – internal rewind option |
| T308M-PRINTER | Tyco T308M thermal printer – standard |
| T308S-N-PRINTER | Tyco T308S thermal printer – network capabilities |
| T312S-PRINTER | Tyco T312S thermal printer – standard |
| T312S-C-PRINTER | Tyco T312S thermal printer – cutter option |
| T312S-R-PRINTER | Tyco T312S thermal printer – internal rewind option |
| T312M-PRINTER | Tyco T312M thermal printer – standard |
| T312M-R-PRINTER | Tyco T312M thermal printer – internal rewind option |

T400 Series High performance and high speed thermal transfer printers

The T408M is a high performance, high speed thermal transfer printer with a 5" 203 dpi print head. The rugged and durable all metal construction makes the T408M suitable for demanding industrial and commercial environments.

The enhanced memory and dual 32-bit processor provide extremely fast data processing and print speeds. The T408M is the best option for high volume output and up to 24 hour duty cycles. It is ideal for use with the full range of Tyco TMS and H.S.I. wire marker sleeves and thermal transfer printable pressure sensitive label products. The T408M has a multilingual back-lit LCD display and dual media sensors. Optional accessories are available for added convenience and efficiency.



Printer specifications

| | |
|-------------------------|---|
| Print head width | 128 mm (5.04")* |
| Print head resolution | 8 dpmm (203 dpi)* |
| Print speed (maximum) | 305 mm per second (12 inches per second) |
| Media sensor | Transmissive and reflective – adjustable |
| Memory | 16 MB SDRAM and 4 MB flash |
| Communication interface | Bi-directional parallel port and RS232C/422/485 serial port |
| Printer dimensions | 283 mm W x 495 mm D x 394 mm H (11.2" W x 19.5" D x 15.5" H) |
| Printer weight | 25 kg (55 lbs) |

Media specifications

| | |
|-----------------------------|----------------|
| Maximum print width | 128 mm (5.04") |
| Maximum media width | 140 mm (5.51") |
| Minimum media width | 40 mm (1.57") |
| Maximum media roll diameter | 203 mm (8.0") |
| Media core diameter | 76 mm (3.0") |
| Ribbon wind | Ink side out |

Product order code

| | |
|-----------------|--|
| T408M-PRINTER | |
| T408M-R-PRINTER | |

Description

| |
|---|
| Tyco T408M thermal printer – standard |
| Tyco T408M thermal printer – internal rewind option |

T400 Series printers are available in wider and higher resolution print heads for specialty identification applications. Please contact your local Tyco Electronics representative for such product configuration requirements.

tyco**Electronics**

Printers

T612M-DS Double sided thermal transfer printer

Specifically designed by Tyco, the T6 12M-DS printer answers a common need in heat-shrinkable wire and cable identification markers: single-pass printing onto both the front and back side of the markers simultaneously. Specifically developed and modified by Tyco for this application, the T6 12M-DS is a high duty cycle, industrially robust thermal transfer printer. It will print onto the complete range of TMS System Six heat-shrinkable markers in all sizes from $\frac{3}{32}$ " (2.4 mm) to $2\frac{1}{4}$ " (57.2 mm). The data printed onto the two sides of each marker can be identical or different, same side up or flipped.

**Printer specifications**

| | |
|-------------------------|---|
| Print head width | 128 mm (5.04") |
| Print head resolution | 12 dpmm (304 dpi) |
| Print speed (maximum) | 50 to 128 mm per second (2 [recommended] to 5 inches per second) |
| Media sensor | Transmissive and gap |
| Memory | 12MB DRAM and 1 MB flash |
| Communication interface | Parallel (centronics) and serial (RS232/422) |
| Printer dimensions | 559 mm W x 432 mm D x 508 mm H (22" W x 17" D x 20" H) |
| Printer weight | 38 kg (84 lbs) |

Media specifications

| | |
|-----------------------------|-----------------|
| Maximum print width | 112mm (4.4") |
| Maximum media width | 117 mm (4.625") |
| Maximum media roll diameter | 254 mm (10.0") |
| Media core diameter | 26 mm (3.0") |
| Ribbon wind | Ink side out |

Product order code

T612M-DS-PRINTER

Description

Tyco T6 12M-DS thermal printer – standard

AM6310 Heavy duty dot matrix printer

Specifically designed by Tyco, the AM6310 is a heavy duty industrial dot matrix printer with a high impact 24-pin print head. Automatic media thickness detection and a high impact print head make the AM6310 the best industrial printer available for heavy gauge wire marker and tag materials, and the 24-pin print head produces high quality text printing with fast print speeds. It is ideal for use with the full range of Tyco TMS and H.S.I. wire marker sleeves and dot matrix printable pressure sensitive label and tag products.



Printer specifications

| | |
|-------------------------|---|
| Print head | 24-pin high-impact dot matrix |
| Print speed | Max. high-speed draft: 600 cps at 12 cpi Letter quality: 160 cps at 12 cpi |
| Print direction | Bi-directional, logic seeking |
| Control panel | LCD, 12 keys, select-dial and quick access setup menu |
| Feed mechanism | Tractor (single or dual) |
| Memory | 2 MB flash |
| Input buffer | 80 KB |
| Communication interface | Parallel port (centronics 36-pin) and serial port (RS232/DB25) |
| Printer dimensions | 483 mm W x 427 mm D x 208 mm H 19.0" W x 16.0" D x 8.2" H |
| Printer weight | 18.1 kg (40 lbs) |

Media specifications

| | |
|---------------------|----------------|
| Maximum print width | 279 mm (11.0") |
| Maximum media width | 305 mm (12.0") |
| Minimum media width | 25 mm (1.0") |

Product order code

- AM6310-110V
- AM6310-230V
- AM6310D-110V
- AM6310D-230V

Description

- Tyco AM6310 dot matrix printer – standard 110 V
- Tyco AM6310 dot matrix printer – standard 230 V
- Tyco AM6310 dot matrix printer – dual tractor 110 V
- Tyco AM6310 dot matrix printer – dual tractor 230 V

tyco*Electronics*

Printers

LQ870 Light duty dot matrix printer

The LQ870 is a light duty, cost effective dot matrix printer with a 24-pin print head that produces high quality text printing with fast print speeds. The dual tractor feed mechanisms provide stability and reduce waste when printing Tyco wire marker sleeves and label products. The LQ870 is ideal for use with the Tyco range of TMS heat shrinkable wire marker sleeves and dot matrix printable pressure sensitive label products.

**Printer specifications**

| | |
|-------------------------|--|
| Print head | 24-pin impact dot matrix |
| Print speed | Max. high-speed draft: 330 cps at 12 cpi Letter quality: 92 cps at 12 cpi |
| Feed mechanism | Dual tractor |
| Input buffer | 8 KB |
| Printer language | ESC/P2 |
| Communication interface | Parallel port |
| Printer dimensions | 457 mm W x 371 mm D x 173 mm H 18.0" W x 14.6" D x 6.8" H |
| Printer weight | 8.9 kg (19.6 lbs) |

Media specifications

| | |
|---------------------|----------------|
| Maximum print width | 203 mm (8.0") |
| Maximum media width | 254 mm (10.0") |
| Minimum media width | 51 mm (2.0") |

Product order code**Description**

| | |
|--------------------------|--|
| TMS-743-EP-LQ870-PRNT-KT | Tyco LQ870 dot matrix printer – standard 110 V |
| TMS-SIX-PROMO-PRINTER | Tyco LQ870 dot matrix printer – standard 240 V |

LMS-9000 Laser marker

The LMS-9000 laser marker is a low maintenance laser marking system designed for high volume users. It is a highly automated system including cutting to length, postmark rewinding and double sided, one step sleeve marking.

Integrated with WinTotal marker sleeve/label marking software, it is designed for Tyco wire identification sleeves and selected labels.

Features and benefits

- Simultaneous double-sided laser marking option for marker sleeves saves considerable time and eliminates any margin for error.
- Optional handling system designed to handle several Tyco products.
- Laser marking and cutting for kitting in one integrated step eliminates post print cutting and kitting.
- Virtually no product wastage during marking, thanks to a state of the art product recognition and jogging system.
- Optional scoring and marking feature for label products.
- Modular design for easy placement and re-installation.
- Fully integrated software and hardware.
- On screen diagnostics.
- Meets all relevant US and European laser equipment standards.
- Laser parameters pre-set and software controlled.

**Product order code**

LMS-9000

Description

Tyco LMS-9000 laser – standard

Please contact your local Tyco representative for product configuration per your application.

tyco

Electronics

Ribbons

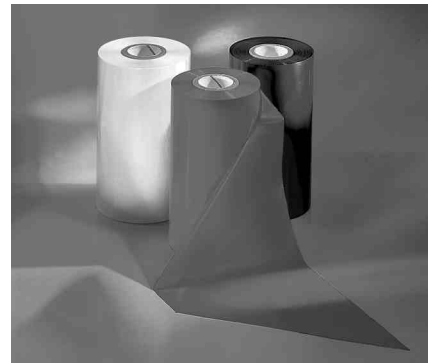
Thermal transfer ribbons**RJS-4RPSCE**

Tyco RJS-4RPSCE is a high durability black resin thermal transfer ribbon tested and approved for use on Tyco TMS-SCE and RPS wire marker sleeve products. For guaranteed print performance and durability use with Tyco recommended compatible printers.

General specifications

| | |
|-----------------------|------------------------|
| Ribbon width | 114 mm (4.5 inches) |
| Ribbon length | 300 meters (984 feet) |
| Ink | Resin |
| Standard color | Black |
| Ribbon wind direction | Ink side out |
| Compatible printers | T312M, T408M, T612M-DS |
| Compatible materials | TMS-SCE, RPS |

** Available in additional sizes and colors by custom quotation*

Ordering information

| | |
|--------------------|--|
| Product order code | TMS-RJS-RIBBON-4RPSCE |
| Description | Tyco 4RPSCE thermal transfer ribbon for T312M, T408M and T612M-DS printers |

101-4RPSCE

Tyco 101-4RPSCE is a high durability black resin thermal transfer ribbon tested and approved for use on Tyco TMS-SCE and RPS wire marker sleeve products. For guaranteed print performance and durability use with Tyco recommended compatible printers.

General specifications

| | |
|-----------------------|----------------------|
| Ribbon width | 110 mm (4.33 inches) |
| Ribbon length | 91 meters (300 feet) |
| Ink | Resin |
| Standard color | Black |
| Ribbon wind direction | Ink side out |
| Compatible printers | T208M, T212M |
| Compatible materials | TMS-SCE, RPS, EP |

Ordering information

| | |
|--------------------|--|
| Product order code | TMS-101-RIBBON-4RPSCE |
| Description | Tyco 4RPSCE thermal transfer ribbon for T208M and T212M printers |

RJS-4HT

Tyco RJS-4HT is a high temperature black resin thermal transfer ribbon tested and approved for use on Tyco HT-SCE high temperature wire marker sleeve products. For guaranteed print performance and durability use with Tyco recommended compatible printers.

General specifications

| | |
|-----------------------|-------------------------------|
| Ribbon width | 114 mm (4.5 inches) |
| Ribbon length | 300 meters (984 feet) |
| Ink | Resin |
| Standard color | Black |
| Ribbon wind direction | Ink side out |
| Compatible printers | T312M, T408M, T612M-DS |
| Compatible materials | HT-SCE, HTCM-SCE (T312M only) |

Ordering information

| | |
|--------------------|---|
| Product order code | TMS-RJS-RIBBON-4HT |
| Description | Tyco 4HT thermal transfer ribbon for T312M, T408M and T612M-DS printers |

101-4HT

Tyco 101-4HT is a high temperature black resin thermal transfer ribbon tested and approved for use on Tyco HT-SCE high temperature wire marker sleeve products. For guaranteed print performance and durability use with Tyco recommended compatible printers.

Ribbons**Thermal transfer ribbons (Cont'd)****General specifications**

| | |
|-----------------------|-----------------------|
| Ribbon width | 114 mm (4.5 inches) |
| Ribbon length | 100 meters (328 feet) |
| Ink | Resin |
| Standard color | Black |
| Ribbon wind direction | Ink side out |
| Compatible printers | T208M, T212M |
| Compatible materials | HT-SCE |

Ordering information

| | |
|--------------------|---|
| Product order code | TMS-101-RIBBON-4HT |
| Description | Tyco 4HT thermal transfer ribbon for T208M and T212M printers |

RJS-4ZH

Tyco RJS-4ZH is a high durability black resin thermal transfer ribbon tested and approved for use on Tyco ZH-SCE zero halogen wire marker sleeve products. For guaranteed print performance and durability use with Tyco recommended compatible printers.

General specifications

| | |
|-----------------------|------------------------|
| Ribbon width | 110 mm (4.33 inches) |
| Ribbon length | 300 meters (984 feet) |
| Ink | Resin |
| Standard color | Black |
| Ribbon wind direction | Ink side out |
| Compatible printers | T312M, T408M, T612M-DS |
| Compatible materials | ZH-SCE |

Ordering information

| | |
|--------------------|---|
| Product order code | TMS-RJS-RIBBON-4ZH |
| Description | Tyco 4ZH thermal transfer ribbon for T312M, T408M and T612M-DS printers |

T200-4ZH

Tyco 101-4ZH is a high durability black resin thermal transfer ribbon tested and approved for use on Tyco ZH-SCE zero halogen wire marker sleeve products. For guaranteed print performance and durability use with Tyco recommended compatible printers.

General specifications

| | |
|-----------------------|----------------------|
| Ribbon width | 110 mm (4.33 inches) |
| Ribbon length | 91 meters (300 feet) |
| Ink | Resin |
| Standard color | Black |
| Ribbon wind direction | Ink side out |
| Compatible printers | T208M, T212M |
| Compatible materials | ZH-SCE |

Ordering information

| | |
|--------------------|---|
| Product order code | T200-RIBBON-4ZH |
| Description | Tyco 4ZH thermal transfer ribbon for T208M and T212M printers |

1910

Tyco 1910 is a high durability high contrast resin/wax thermal transfer ribbon tested and approved for use on the HLX-zero halogen cable marker tape and the HXTM-FB rail tags. For guaranteed print performance use with Tyco recommended printers.

General specifications

| | |
|-----------------------|-----------------------|
| Ribbon width | 110 mm (4.33 inches) |
| Ribbon length | 300 meters (984 feet) |
| Ink | Resin/wax |
| Standard color | Black |
| Ribbon wind direction | Ink side out |
| Compatible printers | T312M, T408M |
| Compatible materials | HLX, HXTM-FB |

Ordering information

| | |
|--------------------|--|
| Product order code | 1910-RIBBON-4T300 |
| Description | Tyco 1910 thermal transfer ribbon for T312M and T408M printers |

tyco**Electronics**

Ribbons

Thermal transfer ribbons (Cont'd)**1950**

Tyco 1950 is a high durability black resin/wax thermal transfer ribbon tested and approved for use on Tyco thermal transfer printable H.S.I. wire marker sleeves and HL cable marker products. See right for compatible materials. For guaranteed print performance and durability use with Tyco recommended compatible printers.

General specifications

| | |
|-----------------------|----------------------------|
| Ribbon width | 110 mm (4.33 inches) |
| Ribbon length | 300 meters (984 feet) |
| Ink | Resin/wax |
| Standard color | Black |
| Ribbon wind direction | Ink side out |
| Compatible printers | T312M, T612M-DS |
| Compatible materials | D-SCE, HC, HL, HLX, HS, HX |

Ordering information

| | |
|--------------------|---|
| Product order code | 1950-RIBBON-4T300 |
| Description | Tyco 1950 thermal transfer ribbon for T312M and T612M-DS printers |

3300

Tyco 3300 is a high durability black resin thermal transfer ribbon tested and approved for use on Tyco thermal transfer printable pressure sensitive labels. See right for compatible materials. For guaranteed print performance and durability use with Tyco recommended compatible printers.

General specifications

| | |
|-----------------------|---|
| Ribbon width* | 110 mm (4.33 inches) |
| Ribbon length* | 300 meters (984 feet) |
| Ink | Resin |
| Standard color* | Black |
| Ribbon wind direction | Ink side out |
| Compatible printers | T308S, T312S, T312M, T408M |
| Compatible materials | CP, HM, HPK, HW, MP, MV, NC, PVF, SB, TN, TTP, TTVF, WP, WV |

*Available in additional sizes and colors by custom quotation

Ordering information

| | |
|--------------------|--|
| Product order code | 1330-3300-10 |
| Description | Tyco 3300 thermal transfer ribbon for all T300 and T400 printers |

3300-101TT

Tyco 3300-101TT is a high durability black resin thermal transfer ribbon tested and approved for use on Tyco thermal transfer printable pressure sensitive labels. See right for compatible materials. For guaranteed print performance and durability use with Tyco recommended compatible printers.

General specifications

| | |
|-----------------------|---|
| Ribbon width* | 110 mm (4.33 inches) |
| Ribbon length* | 91 meters (300 feet) |
| Ink | Resin |
| Standard color* | Black |
| Ribbon wind direction | Ink side out |
| Compatible printers | T208M, T212M |
| Compatible materials | CP, HM, HPK, HW, MP, MV, NC, PVF, SB, TN, TTP, WP, WV |

*Available in additional sizes and colors by custom quotation

Ordering information

| | |
|--------------------|--|
| Product order code | 1330-3300-101TT |
| Description | Tyco 3300 thermal transfer ribbon for T208M and T212M printers |

RHD

Tyco RHD is a high durability black resin thermal transfer ribbon tested and approved for use on Tyco thermal transfer printable pressure sensitive labels. See right for compatible materials. For guaranteed print performance and durability use with Tyco recommended compatible printers.

Ribbons

Thermal transfer ribbons (Cont'd)

General specifications

| | |
|-----------------------|---|
| Ribbon width* | 110 mm (4.33 inches) |
| Ribbon length* | 300 meters (984 feet) |
| Ink | Resin |
| Standard color* | Black |
| Ribbon wind direction | Ink side out |
| Compatible printers | T308S, T312S, T312M, T408M |
| Compatible materials | CP, HM, HPK, HW, MP, MV, NC, PVF, TN, TTP, WP |

* Available in additional sizes and colors by custom quotation

Ordering information

| | |
|--------------------|---|
| Product order code | 1330-0607-10 |
| Description | Tyco RHD thermal transfer ribbon for all T300 and T400 printers |

RHT

Tyco RHT is a high temperature black resin thermal transfer ribbon tested and approved for use on Tyco thermal transfer printable Kapton® labels. See right for compatible materials. For guaranteed print performance and durability use with Tyco recommended compatible printers.

General specifications

| | |
|-----------------------|----------------------------|
| Ribbon width* | 110 mm (4.33 inches) |
| Ribbon length* | 300 meters (984 feet) |
| Ink | Resin |
| Standard color* | Black |
| Ribbon wind direction | Ink side out |
| Compatible printers | T308S, T312S, T312M, T408M |
| Compatible materials | T1K, T2K, TAK, TSK, T2Y |

* Available in additional sizes and colors by custom quotation

Ordering information

| | |
|--------------------|---|
| Product order code | 1330-0619-10 |
| Description | Tyco RHT thermal transfer ribbon for all T300 and T400 printers |

RS

Tyco RS is a high quality black wax thermal transfer ribbon tested and approved for use on Tyco thermal transfer printable paper labels. See right for compatible material. For guaranteed print performance and durability use with Tyco recommended compatible printers.

General specifications

| | |
|-----------------------|----------------------------|
| Ribbon width* | 110 mm (4.33 inches) |
| Ribbon length* | 300 meters (984 feet) |
| Ink | Wax |
| Standard color* | Black |
| Ribbon wind direction | Ink side out |
| Compatible printers | T308S, T312S, T312M, T408M |
| Compatible materials | EP |

* Available in additional sizes and colors by custom quotation

Ordering information

| | |
|--------------------|--|
| Product order code | 1330-0600-10 |
| Description | Tyco RS thermal transfer ribbon for all T300 and T400 printers |

T300-WH

White resin based ribbons are available to print on Tyco Electronics TMS-SCE wire marker sleeve products. For print performance and durability use with Tyco Electronics recommended compatible printers.

General specifications

| | |
|-----------------------|--------------------------|
| Ribbon width* | 110 mm (4.33 inches) |
| Ribbon length* | 300 meters (984 feet) |
| Ink | Resin |
| Standard color* | White |
| Ribbon wind direction | Ink side out |
| Compatible printers | T308M, T312M |
| Compatible materials | TMS-SCE, HM, MP, MV, TTP |

Ordering information

| | |
|--------------------|--|
| Product order code | T300-RIBBON-WH |
| Description | Tyco thermal transfer white ribbon for all T308M, T312M and T408M printers |

tyco*Electronics*

Ribbons

Thermal transfer ribbons (Cont'd)**T200-WH**

White resin based ribbons are available to print on Tyco Electronics TMS-SCE wire marker sleeve products. For print performance and durability use with Tyco Electronics recommended compatible printers.

General specifications

| | |
|-----------------------|--------------------------|
| Ribbon width* | 110 mm (4.33 inches) |
| Ribbon length* | 70 meters (230 feet) |
| Ink | Resin |
| Standard color* | White |
| Ribbon wind direction | Ink side out |
| Compatible printers | T208M, T212M |
| Compatible materials | TMS-SCE, HM, MP, MV, TTP |

Ordering information

| | |
|--------------------|--|
| Product order code | TMS-101-RIBBON-WH-SCE |
| Description | Tyco thermal transfer white ribbon for T200 printers |

T300-WH-4HT

White resin based ribbons are available to print on Tyco Electronics HT-SCE wire marker sleeve products. For print performance and durability use with Tyco Electronics recommended compatible printers.

General specifications

| | |
|-----------------------|-----------------------|
| Ribbon width* | 114 mm (4.49 inches) |
| Ribbon length* | 300 meters (984 feet) |
| Ink | Resin |
| Standard color* | White |
| Ribbon wind direction | Ink side out |
| Compatible printers | T308M, T312M, T408M |
| Compatible materials | HT-SCE |

Ordering information

| | |
|--------------------|--|
| Product order code | T300-RIBBON-WH-4HT |
| Description | Tyco thermal transfer white ribbon for all T308M, T312M and T408M printers |

T200-WH-4HT

White resin based ribbons are available to print on Tyco Electronics HT-SCE wire marker sleeve products. For print performance and durability use with Tyco Electronics recommended compatible printers.

General specifications

| | |
|-----------------------|----------------------|
| Ribbon width* | 110 mm (4.33 inches) |
| Ribbon length* | 91 meters (298 feet) |
| Ink | Resin |
| Standard color* | White |
| Ribbon wind direction | Ink side out |
| Compatible printers | T208M, T212M |
| Compatible materials | HT-SCE |

Ordering information

| | |
|--------------------|--|
| Product order code | T200-RIBBON-WH-4HT |
| Description | Tyco thermal transfer white ribbon for T200 printers |

Thermal transfer ribbons (Cont'd)

RHCA

RHCA resin based ribbons are specifically designed to print on polyester or metalized polyester Tyco Electronics label products. For print performance and durability use with Tyco Electronics recommended compatible printers. It is not suitable to print on paper or self-laminating products.

General specifications

| | |
|-----------------------|--|
| Ribbon width* | 110 mm (4.33 inches) |
| Ribbon length* | 91 meters (300 feet) |
| Ink | Resin |
| Standard color* | Red, Blue and Green (see ordering information below) |
| Ribbon wind direction | Ink side out |
| Compatible printers | T308S, T308M, T312S, T312M and T408M |
| Compatible materials | HM, HPK, MP, MV, PVF,WP, WV |

Ordering information

| | | | |
|---------------------|---|---------------------|----------------------|
| Product order codes | 1330-0620-10 (Red) | 1330-0621-10 (Blue) | 1330-0622-10 (Green) |
| Description | Tyco thermal transfer color ribbon for all T300 and T400 printers | | |

RHCB

RHCB wax-resin based ribbons are specifically designed to print on paper and self-laminating Tyco Electronics label products. For print performance and durability use with Tyco Electronics recommended compatible printers.

General specifications

| | |
|-----------------------|--|
| Ribbon width* | 110 mm (4.33 inches) |
| Ribbon length* | 300 meters (9840 feet) |
| Ink | Wax-Resin |
| Standard color* | Red, Blue and Green (see ordering information below) |
| Ribbon wind direction | Ink side out |
| Compatible printers | T308S, T308M, T312S, T312M and T408M |
| Compatible materials | EP, SB |

Ordering information

| | | | |
|---------------------|---|---------------------|----------------------|
| Product order codes | 1330-0630-10 (Red) | 1330-0631-10 (Blue) | 1330-0632-10 (Green) |
| Description | Tyco thermal transfer color ribbon for all T300 and T400 printers | | |

Dot matrix ribbons



RIBBON A

Tyco RIBBONA is a permanent black ink dot matrix ribbon tested and approved for use on Tyco TMS-SCE wire marker sleeves and RMK-6 products on the LQ870 printer. See right for compatible materials.

General specifications

| | |
|----------------------|------------------------------------|
| Ink | Standard |
| Standard color | Black |
| Compatible printer | LQ870 |
| Compatible materials | CM-SCE, D-SCE, RMK-6, RPS, TMS-SCE |

Ordering information

| | |
|--------------------|--|
| Product order code | TMS-SYSTEM-SIX-RIBBON-A |
| Description | Tyco dot matrix Ribbon A for LQ870 printer |

RIBBON D

Tyco RIBBOND is a high performance, permanent black ink dot matrix ribbon tested and approved for use on Tyco TMS-SCE wire marker sleeve products on the LQ870 printer. See right for compatible materials.

General specifications

| | |
|----------------------|-----------------------------|
| Ink | High performance |
| Standard color | Black |
| Compatible printer | LQ870 |
| Compatible materials | CM-SCE, D-SCE, RPS, TMS-SCE |

Ordering information

| | |
|--------------------|--|
| Product order code | TMS-SYSTEM-SIX-RIBBON-D |
| Description | Tyco dot matrix Ribbon D for LQ870 printer |

QUICK-DRY LQ870

Tyco QUICK-DRYLQ870 is a quick drying indelible black ink dot matrix ribbon tested and approved for use on Tyco dot matrix printable pressure sensitive labels on the LQ870 printer. See right for compatible materials.

General specifications

| | |
|----------------------|-------------------------------------|
| Ink | RI Quick-Dry |
| Standard color | Black |
| Compatible printer | LQ870 |
| Compatible materials | C, DMVF, E, HLTM, K, M, NMX, PV, TW |

Ordering information

| | |
|--------------------|--|
| Product order code | 1330-0037-00 |
| Description | Tyco Quick-Dry dot matrix ribbon for LQ870 printer |

Dot matrix ribbons**STANDARD AM6310**

Tyco STANDARD AM6310 is a permanent black ink dot matrix ribbon tested and approved for use on Tyco wire marker sleeves and cable marker products on the AM6310 printer. See right for compatible materials.

General specifications

| | |
|----------------------|---|
| Ink | Standard |
| Standard color | Black |
| Compatible printer | AM6310 |
| Compatible materials | CM-SCE, D-SCE, HC, HL, HLTM-FB, HM, HS, RMK-6, RPS, TMS-SCE |

Ordering information

| | |
|--------------------|--|
| Product order code | 1892BK04-RIBBON |
| Description | Tyco standard dot matrix ribbon for AM6310 printer |

HIGH-PERF AM6310

Tyco HIGH-PERF AM6310 is a high performance, permanent black ink dot matrix ribbon tested and approved for use on Tyco wire marker sleeves and cable marker products on the AM6310 printer. See right for compatible materials.

General specifications

| | |
|----------------------|--|
| Ink | High performance |
| Standard color | Black |
| Compatible printer | AM6310 |
| Compatible materials | CM-SCE, D-SCE, HC, HL, HLTM-FB, HL, HM, HS, HX, RMK-6, TMS-SCE |

Ordering information

| | |
|--------------------|--|
| Product order code | 1892BK03-HIGH-PERF-RIBBON |
| Description | Tyco high performance dot matrix ribbon for AM6310 printer |

QUICK-DRY AM6310

Tyco QUICK-DRY AM6310 is a quick drying indelible black ink dot matrix ribbon tested and approved for use on Tyco dot matrix printable pressure sensitive labels on the AM6310 printer. See right for compatible materials.

General specifications

| | |
|----------------------|--|
| Ink | RI Quick-Dry |
| Standard color | Black |
| Compatible printer | AM6310 |
| Compatible materials | C, DMVF, E, HLTM, HPC, HPTM, K, M, NMX, PV, TW |

Ordering information

| | |
|--------------------|---|
| Product order code | 1892BK01 |
| Description | Tyco Quick-Dry dot matrix ribbon for AM6310 printer |

WinTotal Wire marker and label printing software

WinTotal software is a powerful 32-bit label/marker design package that makes wire marker printing simple in an industrial environment. Running in the familiar Windows environment, the package is pre-loaded with all the Tyco wire identification products to facilitate marker design. The software features a highly graphical user interface to simplify operator training and minimize errors. The Windows environment gives access to a huge array of font options, including non-English fonts such as Chinese, Japanese and Hebrew (when used with appropriate operating systems or add-on software), and also allows simple importing and manipulation of graphics and logos. Bar code printing is available.

WinTotal software supports all common wire identification needs, including:

- Manual printing
- Automatic set printing from spreadsheets, databases or other CAD systems (including Tyco's HamWare™ harness design software package)
- Incremental alpha and numeric fields
- Double-sided marker printing
- Automatic or manual routing or multiple printers
- Paper output option
- Wraparound marker production
- User-defined products
- Programmable buttons for repeated data insertion

The software can be password protected at different levels to prevent unauthorized use, and can be run on networked computers so that the design function can be separated from printing. The display can be set to several different languages, and a full on-screen Help function is incorporated.

Running behind the simple WinTotal user interface is a powerful label-making package, so the software can be used to design and print general labeling applications such as rating plates and shipping labels.

Features and benefits

- Powerful wire marker design and print software.
- Familiar Windows user environment.
- Pre-loaded with Tyco identification products.
- Powerful import and export functions: reads wire lists from spreadsheets, databases and text files from CAD systems.
- Printer multi-tasking.
- Multiple on-screen languages.

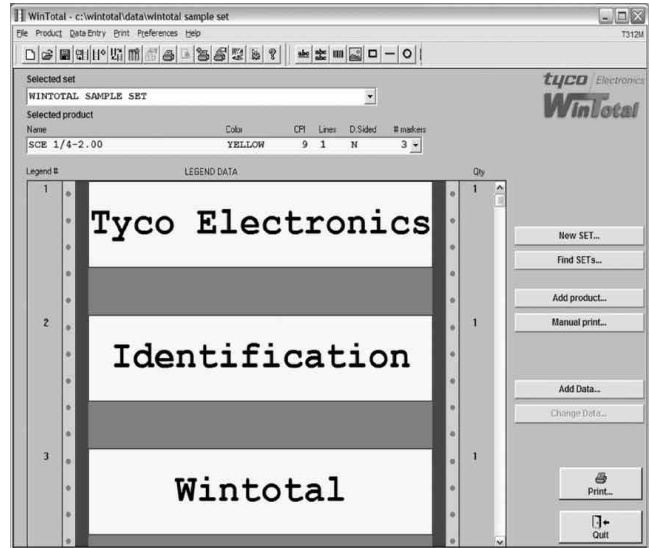

WinTotal Wire marker and label printing software (Cont'd)

Label design

- WYSIWYG label design and display.
- Align text left, right, justified or center.
- Built-in printer font support.
- Windows True Type fonts.
- Lines, boxes and graphic images.
- Resize, rotate and stretch text, graphics and bar codes.
- Thumbnail preview of saved labels.

Printing

- Set and batch printing capabilities.
- Multiple application port printing (MAPP).
- Double sided marker printing.
- Local or network printer support.
- Number of identical or serialized copies selectable from database.

Serialization

- Increment or decrement by any interval.
- Numeric, alphanumeric and custom base serialization.

Database options

- Microsoft ODBC support, including: Access, Excel and dBase.
- ASCII text files.
- AutoCad importing.

Data management

- Visual Basic scripting for custom data processing.
- Shareable data fields.
- Multiple products within one set or batch.

Minimum recommended computer configuration

| | |
|---------------------|--|
| Computer | IBM-compatible PC |
| Processor | Intel Pentium® processor, 400 MHz minimum |
| RAM | 64 MB minimum (128 MB for Windows NT and 2000) |
| Operating system | Windows 95, 98, ME or NT |
| Disk space required | 15 MB minimum |

Other technical information

| | |
|--------------------------|--|
| Barcode types | Codabar, code 39, code 93, code 128, EAN-13, EAN-8, UPC-E, Interleaved 2/5, ITF (DUN 14) |
| Company logo or graphics | Can be imported in BMP, PCX, MSP, WMF, JPG, JIF, GIF formats |
| Text and graphics | Can be rotated, moved or resized |

Ordering information

| | |
|----------------------|--|
| Ordering description | Product description |
| TMS-WINTOTAL-SWARE | Tyco Wire Marker Printing Software – Windows, 32 bit |

PrintEasy Label printing software

Tyco PrintEasy is a powerful yet easy to use Windows based label design and printing software. With PrintEasy you can quickly and easily combine bar codes, text and graphics into professional quality labels. Carefully organized menus and pop-up dialogs display all your options in plain, easy to understand words. The true WYSIWYG display allows you to create and view your labels with precision, giving you total control over your labels' appearance before printing. PrintEasy is ideal for use with the Tyco range of thermal transfer printable pressure sensitive label products. PrintEasy is pre-loaded with all of Tyco's standard thermal transfer label templates, which allows you to simply select the Tyco part number you want to print and you are ready to go!

Features & benefits**Support**

- Free technical support.
- OS Support: Windows 95, 98, ME, NT, 2000, XP.
- International language support.

Label design

- True WYSIWYG label design and display.
- Built-in printer font support.
- Windows True Type fonts.
- Reverse (white on black) text printing.
- Align text left, right, justified or center.
- Unlimited Undo/Redo command.
- Lines, boxes and graphic images.
- Import graphics in BMP, JPG, TIF, PCX, DCX, DIB, EPS and others.
- Resize, rotate and stretch objects.
- Thumbnail preview of saved labels.
- Metric and US measurement systems.

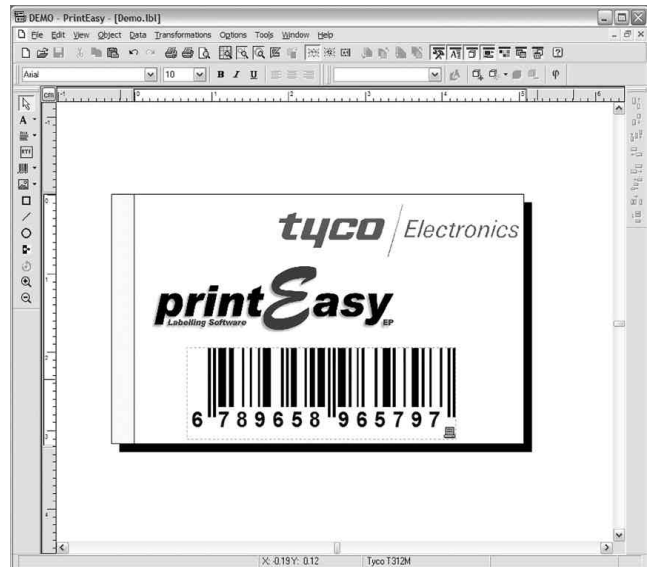
**Bar codes**

- Numerous 1D and 2D symbologies.
- Unlimited width and height.
- Sequentially numbered bar codes.
- Place characters above or below bar codes or do not print.
- Option to display Start/Stop characters.

Printing

- Printer-based bar codes and serial numbers.
- Speed optimization using repetitive data control.
- Local or network printer support.
- Performance-enhancing printer controlled serialization.
- Number of identical or serialized copies selectable from data-base.

PrintEasy Label printing software (Cont'd)**Serialization**

- Increment or decrement by any interval.
- Separate Rollover/Rollunder and Value Reset options.
- Preserve or expand field length when rolling over.
- Numeric, alphanumeric and custom base serialization.

Database options

- Microsoft ODBC support, including: Access, Btrieve, dBase, Excel, Oracle, Paradox, Clipper, FoxPro, Interbase and more.
- ASCII text files.
- SAP (mySAP.com and R/3).
- Versatile multiple-table data access.
- Import variable graphics from databases.
- Data query wizard.
- Individual record-picking at print time.

Data management

- Visual Basic scripting for custom data processing.
- User-definable minimum and maximum field lengths.
- Customizable data-entry filters and error checking.
- Multi-data source selection per label object.
- Easy entry of special and unprintable control characters.
- Shareable data fields.
- Customizable message box handling.

Integration

- Command line interface option.
- Pre-loadable into "background" to avoid start-up delays.
- Dynamically selectable label formats and data sources.
- Error logging.

Ordering information

| Ordering description | Product description |
|----------------------|--|
| BT32-PRO | Tyco BT Label Printing Software – Windows, 32-bit Pro Version, full thermal transfer support |
| TTS 03/N05 | Tyco Enhanced Label Printing Software – Network Version |

- PrintEasy – Pro Tyco label printing software - Windows, 32-bit, Professional Version
- PrintEasy – Suite Tyco label printing software - Windows, 32-bit, Suite Version
- PrintEasy – Net05 Tyco labelprinting software - Windows, 32-bit, 5-user Network Version

tyco**Electronics**

Application Systems

Hot Air Gun

The Tyco Hot Air Gun is an electronic heating tool with adjustable heat settings from +49°C to +593°C (+120°F to +1100°F), and automatic temperature control for precise temperature output. It is ideal for use with the Tyco range of TMS and H.S.I. heat shrinkable wire marker sleeves. This HotAirGun is lightweight in design with easy, quiet operation. The ceramic encapsulated heating element provides exceptional durability and long life.

Optional accessories are available for added convenience and efficiency.

Specifications

| | |
|----------------------------|--------------------------------------|
| 120 V power requirement | 120 V, 60 Hz, 12.5 A |
| 230 V power requirement | 230 V, 50 Hz, 8.7 A |
| Rated heater element power | 1500 W |
| Weight | 850 g (1.9 lb) |
| Cord length | 2.4 m (8 ft) |
| Typical temperature output | +49°C to +593°C +120°F to +1100°F |

Optional accessories and replacement parts

| | |
|-------------------|--|
| HL1802E-BENCH-STD | Bench stand, clip-on. |
| HL1802E-074616 | Reflector nozzle, for small diameter sleeves/tubing |
| HL1802E-070519 | Reflector nozzle, for large diameter sleeves/tubing |
| HL1802E-070618 | Reduction nozzle (9 mm), for pinpoint air-flow control |

Ordering description Product description

| | |
|------------------|---|
| HL1802E-KIT-120V | Hot air gun kit, 120 V power/reflector accessory (small) |
| HL1802E-KIT-230V | Hot air gun kit, 230 V power /reflector accessory (small) |







Electronics

PRE-PRINT SERVICES

Pre-Print Services129



PERMARK®

Permark®130



RAIL—SIGNAL PRODUCTS

HPTM Fabric132
HPKTM Polypropylene134
HLTM-FB/HXTM-FB Polyolefin136



APPLICATION SYSTEMS

TP Tape138



Preprinted bar code labels



Since 1986 we've met the diverse needs of commercial, industrial, governmental and institutional customers by providing innovative solutions to their unique bar code label requirements. Solutions include custom sizes, colors, graphics, laminations, special adhesives, die-cuts and original creative designs.

Quality materials

Tyco Electronics Identification buys master rolls of label stock and converts it to meet the needs of our customers. Our purchasing power, combined with our converting capabilities, allows us to provide the highest quality materials at great prices.

Sequential number tracking

If your application requires sequential numbering, Tyco will keep an automated log of sequence numbers printed for each order. Even if you have an assortment of labels, multiple locations, or use subcontractors to produce your product, we will insure that there are no duplicate numbers printed — guaranteed!

Production proofs

For every new label job, Tyco will provide a paper copy/electronic proof of your label prior to running the job. This allows you to review and approve the size, layout and graphics on the label prior to a full production run.

20 step quality check

Tyco enforces more than 20 quality checks during the manufacturing and quality assurance processes: these quality checks include many automated tests with state of the art equipment. We test every roll of labels for readability, accuracy and scan rates and we will not ship any labels that do not pass our quality assurance tests.

For more information, contact a Tyco customer service representative at:

US 1-800-430-7226
Europe +44(0) 1495 244 000

High Temperature Harsh Environment Circuit Board

Pallet/Carton

Product ID

Security

Asset Tag

Vertical Rack

Signs & Magnetic Labels Also Available



Electronics

Permark®

Permark® 316

Tyco Permark 316 stainless steel markers are recommended for marking in hostile environments. Using state-of-the-art technology and no inks, the marking process produces a permanent, deep surface mark with a darkened character in high contrast to the background. Permark® markers are produced to individual customer requirements on a fast turn-around basis with the flexible and easy-to-use Permark software that allows electronic or manual data entry. Completed markers are supplied in customer defined kits for ease of installation. We recommend installation with 316 stainless steel cable ties.

Features and benefits

- Pre-marked to customer requirements.
- Customer-defined kits for ease of installation.
- Excellent character legibility.
- One-piece, 316 stainless steel construction.
- Variety of fixing methods.
- Mark will endure the lifetime of a Permark S/S marker.
- Excellent resistance to weather extremes and high levels of UV light.
- Resistant to corrosive marine and industrial atmospheres.
- Excellent resistance to a variety of hydrocarbons, organic chemicals, acids, alkalis and inorganic salts. For resistance to a specific chemical, contact your local Tyco representative.



Temperature rating

Operating temperature range -80°C to +500°C -112°F to +932°F

Printer information

Pre-printed per customer requirements.

Part numbering system

PM 0 7507-1-4-5

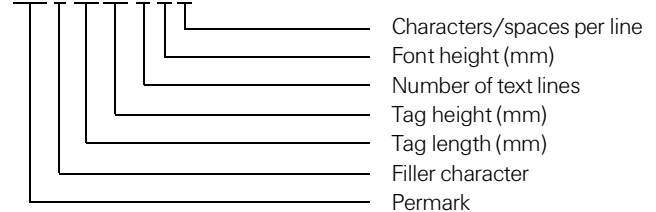

Available sizes and formats

| Ordering description | Product description | Size (L x H) | | Printable area (L x H) | |
|--|---------------------------|--------------|-------------|------------------------|-------------|
| | | mm | inches | mm | inches |
| PM095 12-<# text lines><# characters> | Pre-marked 316 S/S marker | 95 x 12 | 3.74 x 0.47 | 55 x 10 | 2.16 x 0.40 |

Options

| | |
|------------------|---|
| Fonts | Various available |
| Lines per marker | One, two or three (Determined by selected font height. Minimum 1 mm / 0.04" spacing between lines.) |
| Saddle fixings | 13 mm L x 2.4 mm H (0.51" L x 0.09" H) |
| Hole fixings | 7 mm (0.28") |
| Standard colors | Metallic |

| Font heights | Characters per line | |
|-----------------|---------------------|-----------|
| | Standard | Condensed |
| 2.5 mm (0.10") | 30 | N/A |
| 3.0 mm (0.12") | 25 | N/A |
| 4.0 mm (0.16") | 20 | 30 |
| 5.0 mm (0.20") | 15 | 25 |
| 6.0 mm (0.24") | 15 | 25 |
| 8.0 mm (0.31") | 10 | 20 |
| 10.0 mm (0.40") | 10 | 15 |

Available sizes and formats

| Ordering description | Product description | Size (L x H) | | Printable area (L x H) | |
|---------------------------------------|---------------------------|--------------|-------------|------------------------|------------|
| | | mm | inches | mm | inches |
| PM07507-1-<# characters> | Pre-marked 316 S/S marker | 75 x 7 | 2.95 x 0.28 | 50 x 5 | 1.6 x 0.20 |

Options

| | |
|------------------|---|
| Fonts | Various available |
| Lines per marker | One only |
| Saddle fixings | 9.5 mm L x 2.4 mm H (0.37" L x 0.09" H) |
| Hole fixings | None |
| Standard colors | Metallic |

| Font heights | Characters per line | |
|----------------|---------------------|-----------|
| | Standard | Condensed |
| 4.0 mm (0.16") | 15 | 25 |
| 5.0 mm (0.20") | 10 | 20 |

HPTM Adhesive rail terminal tags for dot matrix printing

Tyco HPTM is a specially formulated heavy gauge fabric material with a high tack permanent acrylic adhesive, designed for applications in control panel backboards for rail signal circuit identification.

The standard 1.0" hole pitch design meets AAR terminal post specifications and makes installation fast and convenient.

HPTM adheres to most smooth surfaces including bare and painted metal, as well as painted plywood used for rail signal terminal boards. It is resistant to common fluids, lubricants and solvents.

For guaranteed print performance and durability, use with Tyco's RI Quick-Dry series ribbon.

Features and benefits

- Specially formulated fabric material with exceptional tear strength.
- Dot matrix printable.
- Performance exceeds military specifications.
- High-performance acrylic adhesive.

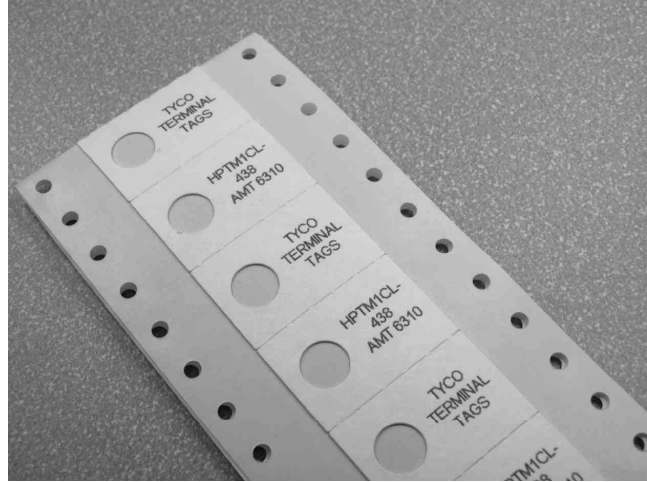

Temperature rating

| | | |
|---------------------------------|----------------|-----------------|
| Operating temperature range | -40°C to +80°C | -40°F to +176°F |
| Minimum application temperature | +10°C | +50°F |

Specifications/approvals

| | |
|----------|---|
| Military | SAE AS81531 4.6.2 MIL-STD-202F method 215J |
| Industry | AAR Terminal Post |

Printer information

| | |
|--------------|---|
| Tyco printer | AM6310 (dot matrix) |
| Tyco ribbon | 1892BK04 (dot matrix) 1892BK03 (dot matrix – high performance) |

Part numbering system

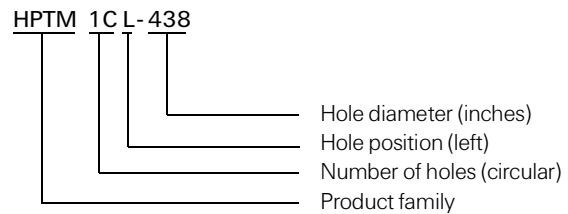

Ordering information



Available sizes and formats

| Ordering description | Hole position | (A) Tag width | | (B) Tag height | | (C) Vertical repeat | | (D) Web width | | (E) Hole diameter | |
|----------------------|---------------|---------------|---------------|----------------|---------------|---------------------|---------------|---------------|---------------|-------------------|---------------|
| | | mm | <i>inches</i> | mm | <i>inches</i> | mm | <i>inches</i> | mm | <i>inches</i> | mm | <i>inches</i> |
| HPTM1CL-312 | Left | 38.10 | <i>1.500</i> | 25.40 | <i>1.000</i> | 25.40 | <i>1.000</i> | 76.20 | <i>3.000</i> | 7.90 | <i>0.312</i> |
| HPTM1CR-312 | Right | 38.10 | <i>1.500</i> | 25.40 | <i>1.000</i> | 25.40 | <i>1.000</i> | 76.20 | <i>3.000</i> | 7.90 | <i>0.312</i> |
| HPTM1CL-438 | Left | 38.10 | <i>1.500</i> | 25.40 | <i>1.000</i> | 25.40 | <i>1.000</i> | 76.20 | <i>3.000</i> | 11.10 | <i>0.438</i> |
| HPTM1CR-438 | Right | 38.10 | <i>1.500</i> | 25.40 | <i>1.000</i> | 25.40 | <i>1.000</i> | 76.20 | <i>3.000</i> | 11.10 | <i>0.438</i> |
| HPTM1CL-500 | Left | 38.10 | <i>1.500</i> | 25.40 | <i>1.000</i> | 25.40 | <i>1.000</i> | 76.20 | <i>3.000</i> | 12.70 | <i>0.500</i> |
| HPTM1CR-500 | Right | 38.10 | <i>1.500</i> | 25.40 | <i>1.000</i> | 25.40 | <i>1.000</i> | 76.20 | <i>3.000</i> | 12.70 | <i>0.500</i> |

Options

| | | |
|---------------|----------|-----------------|
| Package sizes | Standard | 1000 piece pack |
| Colors | Standard | White |

HPKTM Adhesive-backed polypropylene tags for thermal transfer printing

Tyco HPKTM is a semi-rigid polypropylene film with a permanent acrylic adhesive that is designed for application to control panel backboards for rail signal circuit identification. The standard 1.0" hole pitch design meets AAR terminal post specifications and makes installation fast and convenient. HPKTM adheres to most smooth surfaces including bare and painted metal, as well as painted plywood used for rail signal terminal boards. It is resistant to common fluids, lubricants and solvents. For guaranteed print performance and durability, use with Tyco's RHD series ribbon.

Features and benefits

- Self-adhesive backing for quick and easy fixing.
- Thermal transfer printable.
- Recommended for indoor use.
- Resistant to common fluids, lubricants and solvents.



Temperature rating

Operating temperature range -29°C to +80°C -24°F to +176°F

Specifications/approvals

Industry AAR Terminal Post

Printer information

Tyco printer T308S* (thermal transfer)
 Tyco ribbon 1330-0607-10* (thermal transfer)

**Alternative printers and ribbons are available for special applications. Contact Tyco Electronics Identification for more information.*

Part numbering system

HPKTM 1C L - 312



Ordering information

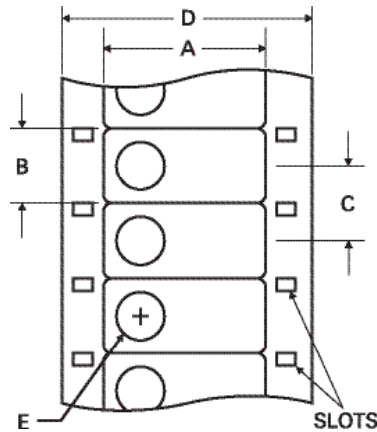

Available sizes and formats

| Ordering description | Hole position | (A) Tag width | | (B) Tag height | | (C) Vertical repeat | | (D) Web width | | (E) Hole diameter | |
|----------------------|---------------|---------------|---------------|----------------|---------------|---------------------|---------------|---------------|---------------|-------------------|---------------|
| | | mm | <i>inches</i> | mm | <i>inches</i> | mm | <i>inches</i> | mm | <i>inches</i> | mm | <i>inches</i> |
| HPKTM1CL-312 | Left | 38.10 | <i>1.500</i> | 25.40 | <i>1.000</i> | 25.40 | <i>1.000</i> | 76.20 | <i>3.000</i> | 7.90 | <i>0.312</i> |
| HPKTM1CR-312 | Right | 38.10 | <i>1.500</i> | 25.40 | <i>1.000</i> | 25.40 | <i>1.000</i> | 76.20 | <i>3.000</i> | 7.90 | <i>0.312</i> |
| HPKTM1CL-438 | Left | 38.10 | <i>1.500</i> | 25.40 | <i>1.000</i> | 25.40 | <i>1.000</i> | 76.20 | <i>3.000</i> | 11.10 | <i>0.438</i> |
| HPKTM1CR-438 | Right | 38.10 | <i>1.500</i> | 25.40 | <i>1.000</i> | 25.40 | <i>1.000</i> | 76.20 | <i>3.000</i> | 11.10 | <i>0.438</i> |
| HPKTM1CL-500 | Left | 38.10 | <i>1.500</i> | 25.40 | <i>1.000</i> | 25.40 | <i>1.000</i> | 76.20 | <i>3.000</i> | 12.70 | <i>0.500</i> |
| HPKTM1CR-500 | Right | 38.10 | <i>1.500</i> | 25.40 | <i>1.000</i> | 25.40 | <i>1.000</i> | 76.20 | <i>3.000</i> | 12.70 | <i>0.500</i> |

Additional sizes and formats available by custom quotation.

Options

| | | |
|--------------|------------------|-------|
| Package size | 1,000 piece pack | |
| Colors | Standard | White |

HLTM-FB / HXTM-FB Non-adhesive-backed polyolefin tags for thermal or dot matrix printing

Tyco HLTM-FB/HXTM-FB is a semi-rigid, heavy gauge crosslinked polyolefin material without an adhesive backing, designed for use in a variety of applications including terminal post and terminal board signal circuit identification. The heavy gauge thickness is ideal for applications requiring exceptional durability. Mark permanence exceeds military requirements. They are resistant to common fluids, lubricants, solvents and abrasion. For guaranteed print performance and durability, use with Tyco approved printers and ribbons.

Features and benefits

- Specially formulated polyolefin material.
- Flame retarded.
- Resistant to common fluids, lubricants and solvents.
- Dot matrix (HLTM-FB) or thermal transfer (HXTM-FB) printable.
- Print performance exceeds military standards.

**Temperature rating**

| Operating temperature range | | |
|-----------------------------|-----------------|-----------------|
| HLTM-FB | -55°C to +135°C | -67°F to +275°F |
| HXTM-FB | -30°C to +105°C | -22°F to +221°F |

Specifications/approvals

| | |
|----------|--------------------------|
| Military | SAE AS81531 4.6.2 |
| | MIL-STD-202F Method 215J |

Printer information

| | | |
|--------------|---------|--------------------------------------|
| Tyco printer | HLTM-FB | AM6310* (dot matrix) |
| | HXTM-FB | T312M (thermal transfer) |
| Tyco ribbon | HLTM-FB | 1892BK04* (dot matrix) |
| | HXTM-FB | 1910-RIBBON-4T300 (thermal transfer) |

**Alternative printers and ribbons are available for special applications. Contact Tyco Electronics Identification for more information.*

Part numbering system

HLTM1FBWE-312



Hole diameter

Color

Product family

Ordering information



Available sizes and formats

| Ordering description | Hole position | (A) Tag width | | (B) Tag height | | (C) Vertical repeat | | (D) Web width | | (E) Hole diameter | |
|-----------------------------|---------------|---------------|---------------|----------------|---------------|---------------------|---------------|---------------|---------------|-------------------|---------------|
| | | mm | <i>inches</i> | mm | <i>inches</i> | mm | <i>inches</i> | mm | <i>inches</i> | mm | <i>inches</i> |
| H<format>TM1FB<color>-312 | Left* | 38.10 | <i>1.500</i> | 22.20 | <i>0.875</i> | 25.40 | <i>1.000</i> | 127.00 | <i>5.000</i> | 7.90 | <i>0.312</i> |
| H<format>TM1FB<color>-438 | Left* | 38.10 | <i>1.500</i> | 22.90 | <i>0.900</i> | 25.40 | <i>1.000</i> | 127.00 | <i>5.000</i> | 11.00 | <i>0.438</i> |
| H<format>TM1FB<color>-500 | Left* | 38.10 | <i>1.500</i> | 22.20 | <i>0.875</i> | 25.40 | <i>1.000</i> | 127.00 | <i>5.000</i> | 12.70 | <i>0.500</i> |
| H<format>TM1FB<color>-625** | Left* | 38.10 | <i>1.500</i> | 25.40 | <i>1.000</i> | 50.80 | <i>2.000</i> | 127.00 | <i>5.000</i> | 15.90 | <i>0.625</i> |

* Hole position is versatile (left or right) on HLTM-FB series tags.
 Additional sizes and formats available by custom quotation.

Options

| | | | |
|---------------|----------|--------------------------------|--|
| Package sizes | Standard | 550 piece pack | **300 piece pack (HLTM1FB625/HXTM1FB625) |
| Colors | Standard | White | Yellow |
| | Code | WE | YW |
| Format | L | For dot matrix printable | |
| | X | For thermal transfer printable | |

Ordering example: HLTM1FBWE-312

tyco**Electronics**

Tube and Pipe ID Labels

TP Tape High Performance color-coded cost saving system for tube identification

The system is designed for use as a thermal transfer printable, self-laminating identification for the various types of tubes in the aerospace, defense and marine industry. Made from polyester with a permanent acrylic adhesive, this cost saving system allows you to print on a unique range of pre color-coded labels on demand and eliminates the use and maintenance of paints, stencils, hot-stamps and etching tools. The system even does the job in a fraction of the time compared to similar technologies.

Features and benefits

- Continuous operating temperature of -40°C to $+163^{\circ}\text{C}$ (-40°F to $+325^{\circ}\text{F}$).
- Resists exposure to water, oil, conventional cleaning agents, oil-based solvents and other fluids commonly associated with commercial and military aircraft.
- Color coded to meet MIL-STD-595B requirements.
- Meets MIL-STD-1247 standards for hydraulic lines, fuel lines, oxygen lines, inerting fluid lines, etc.
- Performance tested to RW 2068, a punishing standard for aggressive fluid and temperature resistance in military and commercial aircraft.
- Available in die-cut or continuous formats to cover all ranges of tube diameters.
- Die-cut version available in white or yellow printable area.
- Continuous version available in white* or clear printable area.

**To be used only with TP-CLEAR-CONT over-laminating product*

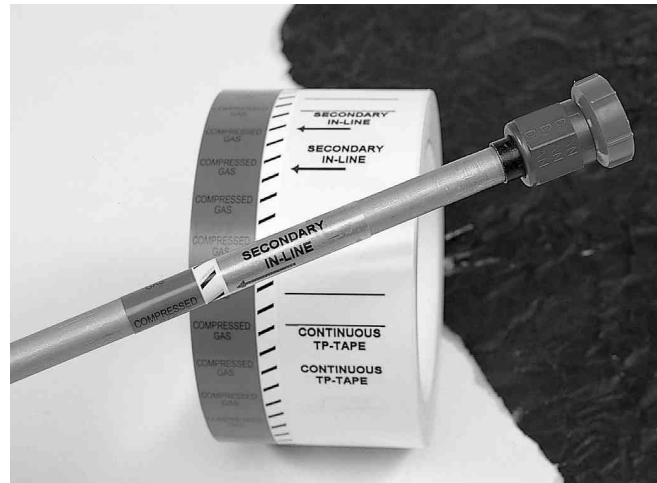
**Temperature rating**

Operating temperature range -40°C to $+163^{\circ}\text{C}$ -40°F to $+325^{\circ}\text{F}$

Specifications/approvals

| | |
|----------|-----------------------------------|
| Tyco | RW 2068 |
| Military | MIL-T-9906C (except initial peel) |
| | MIL-STD-595B |
| | MIL-STD-1247 |
| | MIL-STD-101B |

Printer information

| | |
|--------------|---------------------------------|
| Tyco printer | T308S* (thermal transfer) |
| Tyco ribbon | 1330-0617-10 (thermal transfer) |

**Alternative printers and ribbons are available for special applications. Contact Tyco Electronics Identification for more information.*

Part numbering system**TP3 - PNEU - 1.250**

Size (1.250: for tube with OD of 1.250")
 Tube type (PNEU: for pneumatic lines)
 Product type (TP3: TP Tape type 3, 1.1 turns of printable legend around tube)

Ordering information

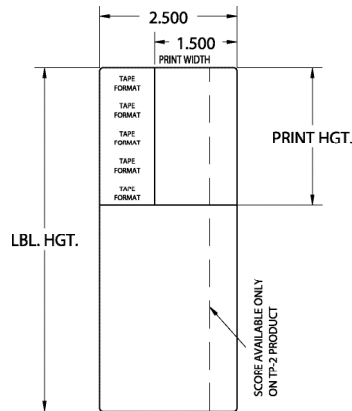

Available sizes and formats

| Order description | Printer type | Label width | | Fits tube diameter | | Labels per pack |
|-------------------------|--------------|-------------|--------|--------------------|--------|-------------------|
| | | mm | inches | mm | inches | |
| TP<format>-(XXXX)-0.188 | Thermal | 63.50 | 2.500 | 4.77 | 0.188 | 2500 |
| TP<format>-(XXXX)-0.250 | Thermal | 63.50 | 2.500 | 6.35 | 0.250 | 2000 |
| TP<format>-(XXXX)-0.312 | Thermal | 63.50 | 2.500 | 7.92 | 0.312 | 2000 |
| TP<format>-(XXXX)-0.375 | Thermal | 63.50 | 2.500 | 9.52 | 0.375 | 1500 |
| TP<format>-(XXXX)-0.500 | Thermal | 63.50 | 2.500 | 12.70 | 0.500 | 1500 |
| TP<format>-(XXXX)-0.625 | Thermal | 63.50 | 2.500 | 15.88 | 0.625 | 1000 |
| TP<format>-(XXXX)-0.750 | Thermal | 63.50 | 2.500 | 19.05 | 0.750 | 1000 |
| TP<format>-(XXXX)-0.875 | Thermal | 63.50 | 2.500 | 22.21 | 0.875 | 750 |
| TP<format>-(XXXX)-1.000 | Thermal | 63.50 | 2.500 | 25.40 | 1.000 | 750 |
| TP<format>-(XXXX)-1.125 | Thermal | 63.50 | 2.500 | 28.58 | 1.125 | 500 |
| TP<format>-(XXXX)-1.250 | Thermal | 63.50 | 2.500 | 31.75 | 1.250 | 500 |
| TP<format>-(XXXX)-1.375 | Thermal | 63.50 | 2.500 | 34.93 | 1.375 | 500 |
| TP<format>-(XXXX)-1.500 | Thermal | 63.50 | 2.500 | 38.10 | 1.500 | 500 |
| TP<format>-(XXXX)-1.625 | Thermal | 63.50 | 2.500 | 41.28 | 1.625 | 400 |
| TP<format>-(XXXX)-1.750 | Thermal | 63.50 | 2.500 | 44.45 | 1.750 | 400 |
| TP<format>-(XXXX)-CONT | Thermal | 63.50 | 2.500 | 50.80+ | 2.000+ | 100 ft continuous |

Options

| Format | None | Standard TP Tape |
|--------|------|---|
| 2 | | For a slit at 2 inches from the left edge (total width 2" /instead of 2.5") |
| 3 | | For 1.1 turns of color-coded label around the pipe instead of 1.5 turns |
| 4 | | For white printable area instead of yellow |
| WE | | For white/slit product for European markets, use order description:TP-WE(XXXX)ST-(size) |

Identification code (XXXX)

| | | | | | |
|--------|--------------------|--------|------------------|-------|-----------------|
| AIRCON | Air conditioning | HYDRO | Hydraulic | PYRO | Pyrotechnic |
| BATACT | Battery activator | INAIR | Instrument air | RAIN | Rain repellent |
| COMGAS | Compressed gas | INERT | Inert fluid | RCAT | Rocket catalyst |
| COOL | Coolant | LUBE | Lubrication | RFUEL | Rocket fuel |
| DEICE | Deicing fluid | MC | Miscellaneous | ROXI | Rocket oxidizer |
| ELECT | Electrical conduit | MONO | Mono propellant | SOLV | Solvent |
| FIRE | Fire protection | OXYGEN | Breathing oxygen | VAC | Vacuum |
| FUEL | Fuel | PNEU | Pneumatic | WATER | Water injection |



TP Tape (Cont'd) Tube line self-laminating labels for thermal transfer printing

| Colors | Brown | Red | Orange | Yellow | Green |
|--------|-------|-------|--------|--------|-------|
| Code | 10076 | 11136 | 12197 | 13655 | 14187 |

Colors conform to Federal Standard FED-STD-595B

Continuous format TP Tape is supplied with respective legends imprinted, as shown below. Die cut formats are not printed. For example, TP3AIRCON-CONT will have AIR CONDITION printed on each label. TP3AIRCON-O.625 will not.

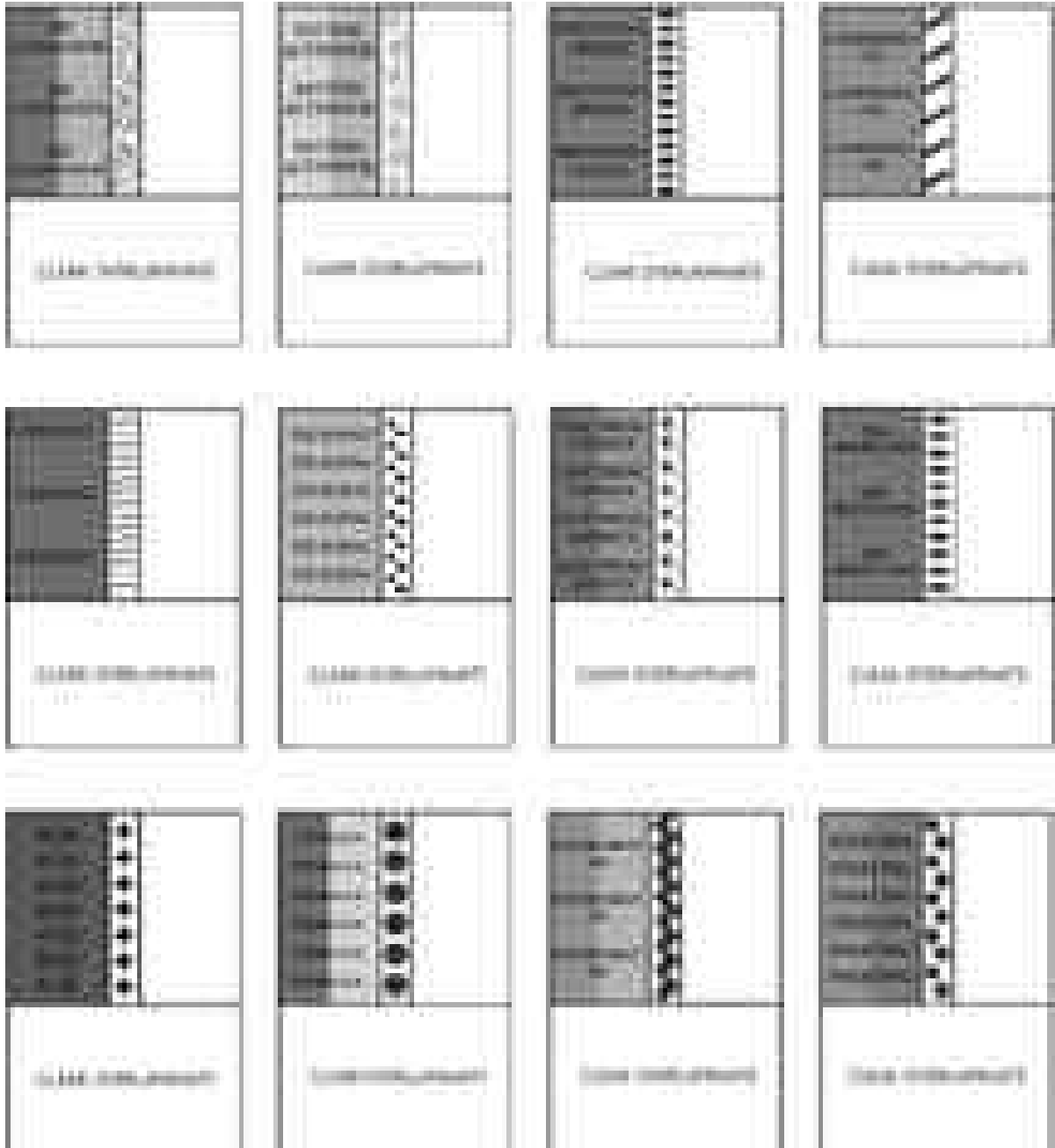

TP Tape (Cont'd) Tube line self-laminating labels for thermal transfer printing

| Colors | Blue | Grey | Black | White | Pink | Light Green |
|--------|-------|-------|-------|-------|-------|-------------|
| Code | 15102 | 16473 | 17038 | 17925 | 21668 | 24664 |

Colors conform to Federal Standard FED-STD-595B

Continuous format TP Tape is supplied with respective legends imprinted, as shown below. Die cut formats are not printed. For example, TP3AIRCON-CONT will have AIR CONDITION printed on each label. TP3AIRCON-0.625 will not.

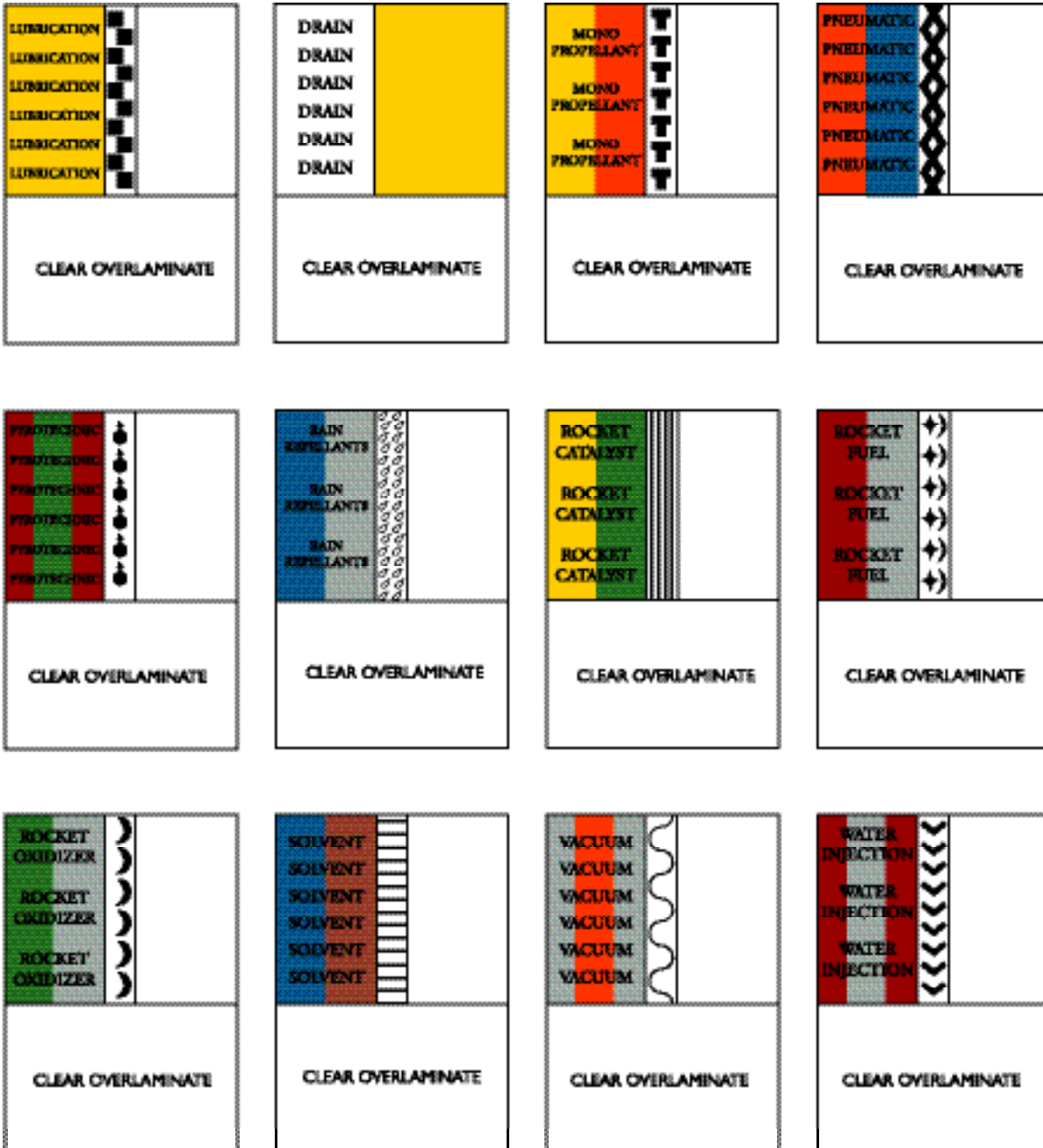

Printer/material/ribbon compatibility cross reference

| Printer | Compatible materials | Standard ribbon |
|------------------|-------------------------------------|-----------------------|
| T312M | TMS-SCE | TMS-RJS-RIBBON-4RPSCE |
| | RPS | TMS-RJS-RIBBON-4RPSCE |
| | HT-SCE | TMS-RJS-RIBBON-4HT |
| | ZH-SCE | TMS-RJS-RIBBON-4ZH |
| | D-SCE | 1950-RIBBON-4T300 |
| | HS/HC | 1950-RIBBON-4T300 |
| | HX | 1950-RIBBON-4T300 |
| | HL | TMS-RJS-RIBBON-4RPSCE |
| | HLX | 1910-RIBBON-4T300 |
| | HXTM-FB | 1910-RIBBON-4T300 |
| | HPK | 1330-0607-10 |
| | HPKTM | 1330-0607-10 |
| | HLTM | 1330-0607-10 |
| | TP tape | 1330-3300-10 |
| | Polyvinyl fluoride (Tedlar®) (TTVF) | 1330-3300-10 |
| | Decals (TTP) | 1330-3300-10 |
| | Self-lams (SB/PVF) | 1330-3300-10 |
| | Polyimide (Kapton®) (T1K/T2K/TSK) | 1330-0619-10 |
| | Nylon cloth (NC) | 1330-0607-10 |
| | Polyesters (WP/MP/CP/HW/HM/MV) | 1330-0607-10 |
| | Destructible polyethylene (TN) | 1330-0607-10 |
| White vinyl (WV) | 1330-3300-10 | |
| Paper (EP) | 1330-0600-10 | |
| T308S or T312S | Self-lams (SB/PVF) | 1330-3300-10 |
| | Polyesters (WP/MP/CP/HW/HM/MV) | 1330-0607-10 |
| | Polyimide (Kapton®) (T1K/T2K/TSK) | 1330-0619-10 |
| | Polyvinyl fluoride (Tedlar®) (TTVF) | 1330-3300-10 |
| | TP tape | 1330-3300-10 |
| | HPK | 1330-0607-10 |
| | HPKTM | 1330-0607-10 |
| | HLTM | 1330-0607-10 |
| | Decals (TTP) | 1330-3300-10 |
| | Nylon cloth (NC) | 1330-0607-10 |
| | Destructible polyethylene (TN) | 1330-0607-10 |
| White vinyl (WV) | 1330-3300-10 | |
| Paper (EP) | 1330-0600-10 | |
| T208M or T212M | TMS-SCE | TMS-101-RIBBON-4RPSCE |
| | RPS | TMS-101-RIBBON-4RPSCE |
| | HT-SCE | TMS-101-RIBBON-4HT |
| | ZH-SCE | T200-RIBBON-4ZH |
| | D-SCE | TMS-101-RIBBON-4DSCE |
| | HPK | 1330-3300-101TT |
| | Polyvinyl fluoride (Tedlar®) (TTVF) | 1330-3300-101TT |
| | Decals (TTP) | 1330-3300-101TT |
| | Self-lams (SB/PVF) | 1330-3300-101TT |
| | Nylon cloth (NC) | 1330-3300-101TT |
| | Polyesters (WP/MP/CP/HW/HM/MV) | 1330-3300-101TT |
| | Destructible polyethylene (TN) | 1330-3300-101TT |
| | White vinyl (WV) | 1330-3300-101TT |
| T408M | TMS-SCE | TMS-RJS-RIBBON-4RPSCE |
| | RPS | TMS-RJS-RIBBON-4RPSCE |
| | HT-SCE | TMS-RJS-RIBBON-4HT |
| | ZH-SCE | TMS-RJS-RIBBON-4ZH |
| | D-SCE | TMS-RJS-RIBBON-4DSCE |
| | HL | TMS-RJS-RIBBON-4RPSCE |
| | HLX | 1910-RIBBON-4T300 |

Printer/material/ribbon compatibility cross reference (Cont'd)

| Printer | Compatible materials | Standard ribbon |
|-------------------|-------------------------------------|---------------------------|
| T408M (Continued) | HXTM-FB | 1910-RIBBON-4T300 |
| | Self-lams (SB/PVF) | 1330-3300-10 |
| | Polyesters (WP/MP/CP/HW/HM/MV) | 1330-0607-10 |
| | Polyimide (Kapton®) (T1K/T2K/TSK) | 1330-0619-10 |
| | Polyvinyl fluoride (Tedlar®) (TTVF) | 1330-3300-10 |
| | TP tape | 1330-3300-10 |
| | HPK | 1330-0607-10 |
| | HPKTM | 1330-0607-10 |
| | HLTM | 1330-0607-10 |
| | Decals (TTP) | 1330-3300-10 |
| | Nylon cloth (NC) | 1330-0607-10 |
| | Destructible polyethylene (TN) | 1330-0607-10 |
| | White vinyl (WV) | 1330-3300-10 |
| | Paper (EP) | 1330-0600-10 |
| AM 63 10 | TMS-SCE | 1892BK04-RIBBON |
| | RPS | 1892BK04-RIBBON |
| | D-SCE | 1892BK04-RIBBON |
| | CM-SCE | 1892BK04-RIBBON |
| | HS/HC | 1892BK04-RIBBON |
| | HX | 1892BK03-HIGH-PERF-RIBBON |
| | HL | 1892BK04-RIBBON |
| | HM | 1892BK04-RIBBON |
| | NMX | 1892BK01 |
| | RMK-6 | 1892BK04-RIBBON |
| | HPC | 1892BK01 |
| | HLTM | 1892BK01 |
| | HPTM | 1892BK01 |
| | HLTM-FB | 1892BK04-RIBBON |
| | Polyvinyl fluoride (Tedlar®) (DMVF) | 1892BK01 |
| | Self-lams (TW/PV) | 1892BK01 |
| | Polyimide (Kapton®) (K) | 1892BK01 |
| | Vinyl cloth (CW) | 1892BK01 |
| | Polyesters (E/M) | 1892BK01 |
| LO870 | TMS-SCE | TMS-SYSTEM-SIX-RIBBON-A |
| | RPS | TMS-SYSTEM-SIX-RIBBON-A |
| | D-SCE | TMS-SYSTEM-SIX-RIBBON-A |
| | CM-SCE | TMS-SYSTEM-SIX-RIBBON-A |
| | NMX | 1330-0037-00 |
| | RMK-6 | TMS-SYSTEM-SIX-RIBBON-A |
| | Polyvinyl fluoride (Tedlar®) (DMVF) | 1330-0037-00 |
| | Self-lams (TW/PV) | 1330-0037-00 |
| | Polyimide (Kapton®) (K) | 1330-0037-00 |
| | Vinyl cloth (CW) | 1300-0037-00 |
| | Polyesters (E/M) | 1330-0037-00 |
| T612M-DS | TMS-SCE | TMS-RJS-RIBBON-4RPSCE |
| | RPS | TMS-RJS-RIBBON-4RPSCE |
| | ZH-SCE | TMS-RJS-RIBBON-4ZH |
| | HT-SCE | TMS-RJS-RIBBON-4HT |
| | D-SCE | TMS-RJS-RIBBON-4DSCE |

Master materials specification cross reference

Label ID products

| Tyco material | Material | Color | Temperature range | | Print technology | Recommended application |
|---------------|---------------------|--------|-------------------|-----------------|------------------|---|
| | | | °C | °F | | |
| C | Vinyl cloth | White | -29°C to +80°C | -20°F to +176°F | Dot matrix | Vinyl coated cloth tape with an aggressive adhesive system. For general use in permanent and removable applications. High material strength facilitates easy, clean removal of tape and adhesive. Easy to write on. Excellent resistance to oil, water and humidity. Less than 0.05% UV transmissibility. Clean adhesive removal within one year. |
| M | Polyester | Silver | -53°C to +93°C | -65°F to +200°F | Dot matrix | Ideal for rating plate applications, graphic symbol identifiers and users who desire a metalized programmable device label. The matte ink receptive coating and Tyco ribbon provide high integrity marking in a variety of environments. Allows less than 0.01% UV transmissibility. UL Listed and CSA Certified. |
| K | Polyimide (Kapton®) | Tan | -40°C to +260°C | -40°F to +500°F | Dot matrix | Ideal for label requirements on circuit boards. Suitable for direct wave (bottom side) and IR reflow (top side) applications. Polyimide film with unique pressure sensitive adhesive designed to withstand the various fluxes, cleaning solvents and molten solder encountered in the manufacture of printed circuit boards. Flash exposure up to 1000°F. |
| E | Polyester | White | -53°C to +93°C | -65°F to +200°F | Dot matrix | Ideal for applications requiring exposure to vapor degreaser. The matte ink receptive coating and Tyco ribbon provide high integrity marking in a variety of environments. Allows less than 0.01% UV transmissibility. UL Listed and CSA Certified. |
| TW | Vinyl | Clear | -54°C to +82°C | -65°F to +180°F | Thermal transfer | An excellent marker for cable, flat ribbon cable, machine tools, tubing or underground wiring. Durable vinyl film with good conformability. Designed to withstand exposure to oil, solvents and water. Supplied with a white print-on or write-on surface for on-the-job marking. |
| WP | Polyester | White | -40°C to +150°C | -40°F to +302°F | Thermal transfer | Ideal for applications requiring a white high-durability label. Gloss white top-coat offers excellent contrast ratios for barcodes. |
| CP | Polyester | Clear | -40°C to +150°C | -40°F to +302°F | Call Tyco | Ideal for applications requiring a clear lamination or as a clear label. |
| HW | Polyester | White | -40°C to +150°C | -40°F to +302°F | Thermal transfer | Ideal for applications that require a high-tack adhesive. White label is excellent for bar code applications. Adhesive is designed to bond to the most demanding surface, including textured and contoured surfaces. |
| HM | Polyester | Silver | -40°C to +150°C | -40°F to +302°F | Thermal transfer | Ideal for rating plate applications and programmable device labels that require a high-tack adhesive. Adhesive is designed to bond to the most demanding surfaces, including textured and contoured surfaces. UL Listed and CSA Certified. |
| MP | Polyester | Silver | -40°C to +150°C | -40°F to +302°F | Thermal transfer | Ideal for rating plate applications and users who desire a metalized programmable device label. |
| MV | Polyester | Silver | -40°C to +150°C | -40°F to +302°F | Thermal transfer | Ideal for rating plate applications and users who desire a label with a silver look and tamper evident feature. Removal after 24 hours results in label fracturing with "VOID" pattern remaining. |
| TN | Polyethylene | White | -40°C to +80°C | -40°F to +176°F | Thermal transfer | Ideal for applications that require serial numbers, calibration information or other tamper proof identifications. Fractures upon removal after 72 hours. |

continued

Master materials specification cross reference (Cont'd)

Label IDproducts (continued)

| Tyco material | Material | Color | Temperature range | | Print technology | Recommended application |
|---------------|---------------------|--------------|-------------------|-----------------|------------------|---|
| | | | °C | °F | | |
| WV | Vinyl | White | -60°C to +95°C | -76°F to +203°F | Thermal transfer | Vinyl film with good conformability to round and flexible surfaces. Excellent for flat ribbon cables that are subjected to repeat bending. Designed to withstand exposure to oil, solvents and water. |
| NC | Cloth | White | -40°C to +140°C | -40°F to +284°F | Thermal transfer | Excellent for irregular surfaces where conformability is desired. Label will conform to round or flexible surfaces, such as tubing, wiring or cables. |
| T1K | Polyimide (Kapton®) | White | -40°C to +260°C | -40°F to +500°F | Thermal transfer | Ideal for label requirements on circuit boards. Suitable for direct wave (bottom side) and IR reflow (top side) applications. Designed to withstand the various fluxes, cleaning solvents and molten solder encountered in the manufacture of printed circuit boards. Excellent for bar code applications. |
| T2K | Polyimide (Kapton®) | White | -40°C to +260°C | -40°F to +500°F | Thermal transfer | Ideal for label requirements on circuit boards. Suitable for direct wave (bottom side) and IR reflow (top side) applications. Designed to withstand the various fluxes, cleaning solvents and molten solder encountered in the manufacture of printed circuit boards. Excellent for auto apply applications. |
| TSK | Polyimide (Kapton®) | White | -40°C to +260°C | -40°F to +500°F | Thermal transfer | Designed for applications where static charge is critical, such as printed circuit boards and related electronic components. Ideal for high temperature labeling requirements and suitable for direct wave (bottom side) and IR reflow (top side) PCB applications. Withstands the fluxes, cleaning solvents and molten solder encountered in the manufacture of PCBs. Provides excellent contrast for bar code applications. |
| TAK | Polyimide (Kapton®) | Amber | -40°C to +260°C | -40°F to +500°F | Thermal transfer | Ideal for high temperature labeling requirements such as printed circuit boards. Suitable for direct wave (bottom side) and IR reflow (top side) PCB applications. Designed to withstand the fluxes, cleaning solvents and molten solder encountered in the manufacture of PCBs. |
| T2Y | Modified polyimide | White | -40°C to +232°C | -40°F to +450°F | Thermal transfer | Ideal for applications requiring a high durability white label that will withstand the temperatures and solvents encountered in printed circuit soldering. Designed as an economic alternative to Tyco's T1K material. Suitable for IR reflow (top side) applications. |
| KTT | Polyimide (Kapton®) | Tan | -40°C to +260°C | -40°F to +500°F | Thermal transfer | Ideal for high temperature labeling requirements such as printed circuit boards. Suitable for direct wave (bottom side) and IR reflow (top side) PCB applications. Designed to withstand the fluxes, cleaning solvents and molten solder encountered in the manufacture of PCBs. |
| PVF | Polyvinyl fluoride | White/Yellow | -40°C to +130°C | -40°F to +266°F | Thermal transfer | Excellent for wire and cable marking and other general labeling applications that require the "self-extinguishing" properties of Tedlar®. Ideal for use in a variety of harsh physical and chemical environments. Resists water, oil, cleaning agents and oil based solvents, and filters ultra-violet light. |
| SB | Vinyl | Clear | -40°C to +80°C | -40°F to +176°F | Thermal transfer | An excellent marker for cable, flat ribbon cable, machine tools, tubing or underground wiring. Durable vinyl film with good conformability. Designed to withstand exposure to oil, solvents and water. Supplied with a white print-on or write-on surface for on-the-job marking. |
| EP | Paper | White | -54°C to +66°C | -65°F to +200°F | Thermal transfer | Ideal for permanent marking in milder environments when economy is required. The white smooth finish is excellent for bar coding applications. Excellent adhesion to most styrenes, polypropylenes, polyethelenes and paper. Adhesion to corrugation often results in the label or substrate tear when removal is attempted. |

Master materials specification cross reference (Cont'd)

| Tyco material | Material | Color | Temperature range | | Print technology | Recommended application |
|---------------|-----------|--------|-------------------|-----------------|------------------|--|
| | | | °C | °F | | |
| LE | Polyester | White | -40°C to +150°C | -40°F to +302°F | Laser | Ideal for general purpose and component labeling. Highly durable image. Ideal for applications requiring a bar code. Top coat designed for use in laser printers. |
| LM | Polyester | Silver | -40°C to +150°C | -40°F to +302°F | Laser | Excellent for component labeling requiring low UV transmissibility. Metal appearance ideal for rating plate applications. Top coat designed for use in laser printers. |

Wire, harness and pipe ID

| Tyco material | Material | Color | Temperature range | | Recommended application |
|---------------|--|-------|-------------------|-----------------|--|
| | | | °C | °F | |
| CM-SCE | Radiation cross-linked polyolefin | | -55°C to +135°C | -67°F to +275°F | A military grade tag ideal for use in aerospace, defense and commercial applications for large diameter cable bundles or harnesses that go beyond the range of heat-shrink identification sleeves. The product has superior mark permanence and can be attached to the wire bundles using cable ties. The product complements the TMS-SCE and RPS product ranges. |
| D-SCE | Radiation cross-linked polyolefin | | -55°C to +135°C | -67°F to +275°F | A military grade product with superior resistance to several fluids, fuels, cleaning agents and chemicals. The product is ideal for use in harsh-environment applications like rail and mass transit, aerospace, defense and industrial plants for permanent identification of wire and cables. The product covers a broad range of wire diameters for ease of use. |
| HL | Radiation cross-linked polyolefin | | -55°C to +135°C | -67°F to +275°F | A performance grade polyolefin cable tag that comes in various widths and lengths to incorporate several sizes and lines of text and is ideal for use in rail and mass transit and industrial applications. The product complements the HS range of heat-shrink identification sleeves and fills the sizes where a heat-shrink sleeve would be difficult to use. |
| HS | Radiation cross-linked polyolefin | | -55°C to +135°C | -67°F to +275°F | A military grade heat-shrink identification product that comes in several different sleeve lengths and expanded diameters to fit a wide range of wire and cables that require variable text to fit a marker from 0.5in in length to a marker that is 6in in length. The product is ideal for use in the rail and mass transit and industrial applications where endurance to harsh environment and a variety of chemicals is a necessity. |
| HLTM | Proprint | | -54°C to +71°C | -65°F to +160°F | A semi-rigid, heavy gauge Proprint without an adhesive backing. Designed for staple application to plywood control panel backboards for rail signal circuit identification. The standard 1.0" hole pitch design meets AAR terminal post specifications and makes installation fast and convenient. Resistant to common fluids, lubricants and solvents. |
| HLTM-FB | Polyolefin | | -55°C to +135°C | -67°F to +275°F | A semi-rigid, heavy gauge crosslinked polyolefin material without an adhesive backing. Designed for use in a variety of applications including terminal post and terminal board signal circuit identification. The heavy gauge thickness is ideal for applications requiring exceptional durability. Mark permanence exceeds military requirements. Resistant to common fluids, lubricants, solvents and abrasion. |
| HLX | Radiation cross-linked zero-halogen polyolefin | | -30°C to +105°C | -22°F to +221°F | A semi-rigid, heavy gauge specially formulated fabric material with a high tack permanent acrylic adhesive that is designed to permanently identify control panel components and racks, as well as general labeling applications that require a high performance, heavy gauge material. It has excellent abrasion resistance and adheres to most smooth surfaces including bare and painted metal. |
| HPC | Tyvek® | | -54°C to +71°C | -65°F to +160°F | A semi-rigid, heavy gauge Tyvek® designed to permanently identify control panel components and racks, as well as general labeling applications that require a high performance heavy gauge material. Excellent abrasion resistance. Adheres to most smooth surfaces including bare and painted metal. |
| HPK | Polypropylene | | -29°C to +80°C | -24°F to +176°F | A semi-rigid, heavy gauge polypropylene film designed to permanently identify control panel components and racks, as well as general labeling applications that require a high performance heavy gauge material. Excellent abrasion resistance. Adheres to most smooth surfaces including bare and painted metal. |
| HPKTM | Polypropylene | | -29°C to +80°C | -24°F to +176°F | A semi-rigid polypropylene film designed for application to control panel backboards for rail signal circuit identification. The standard 1.0" hole pitch design meets AAR terminal post specifications and makes installation fast and convenient. Adheres to most smooth surfaces including bare and painted metal, as well as painted plywood used for rail signal terminal boards. Resistant to common fluids, lubricants and solvents. |
| HPTM | Tyvek® | | -40°C to +80°C | -40°F to +176°F | A semi-rigid, heavy gauge Tyvek® designed for application in control panel backboards for rail signal circuit identification. The standard 1.0" hole pitch design meets AAR terminal post specifications and makes installation fast and convenient. Adheres to most smooth surfaces including bare and painted metal, as well as painted plywood used for rail signal terminal boards. Resistant to common fluids, lubricants and solvents. |

continued

Master materials specification cross reference (Cont'd)

Wire, harness and pipe ID (continued)

| Tyco material | Material | Temperature range | | Recommended application |
|---------------|--|-------------------|-----------------|--|
| | | °C | °F | |
| HT-SCE | Radiation cross-linked fluoropolymer | -55°C to +225°C | -67°F to +437°F | A high-temperature resistant permanent identification sleeve system specifically designed for applications requiring exposure to prolonged temperatures and elevated continuous operating temperatures. The product has exceptional resistance to several fluids, solvents, oils and fuels and it's specifically designed low out-gassing properties make it ideal for use around living beings. The product meets several Military specifications and is recommended by NASA as a low-outgassing permanent identification sleeve system. Typical applications include outer space, aerospace and defense. |
| HTCM-SCE | Radiation cross-linked fluoropolymer | -55°C to +225°C | -67°F to +437°F | A high temperature, low-outgassing tie-on cable tag that complements the HT-SCE identification sleeve product range. Suitable for wire bundles, cables and harnesses that go beyond the size range for the HT-SCE sleeves or require side entry identification, pre or post-termination. The product can be attached using high-temperature resistant cable ties. Recommended on NASA's low-outgassing material list, the product is ideally suited for outer space, aerospace and defense applications. |
| HX | Radiation cross-linked zero-halogen polyolefin | -30°C to +105°C | -22°F to +221°F | Used to identify wires and cables where low fire hazard properties are critical, the zero halogen material coupled with low smoke and toxic fume emissions make this product ideal for use in enclosed spaces such as mass transit, marine and Industrial installations. The product has exceptional mark permanence to common fluids, solvents and chemicals. |
| NBC-SCE | Radiation cross-linked fluoropolymer | -55°C to +225°C | -67°F to +437°F | A specially formulated permanent identification sleeve system specifically designed for use in environments exposed to nuclear, biological and chemical agents. The system when used with the appropriate adhesive and oversleeve meets the requirements of an inert system (contact Tyco for details) to identify wire, cables and harnesses. The product has exceptional resistance to several fluids, solvents and fuels. Typical industrial applications include defense harnesses, aerospace, chemical and pharmaceutical plants and infrastructure. The low out-gassing properties make the product exceptionally well-suited for areas that have close contact with humans. |
| NMX | Polyaramid (Nomex®) | -40°C to +135°C | -40°F to +275°F | A flame retarded polyaramid specially formulated for use in identification of cables and wire bundles as a side entry tag. The tags are attached to the substrate using cable ties. The product is ideal for aerospace and other industries where resistance to harsh environments and weight savings are critical. Available in dot-matrix printable format, the product has exceptional resistance to cleaning fluids, fuels and chemicals commonly associated with the aerospace industry. |
| RMK | Epoxy coated polyester | -40°C to +105°C | -40°F to +221°F | A specially formulated computer printable label stock designed for applications requiring a permanent mark. When printed using recommended printers and cured using a heat-gun, the unique epoxy on the surface locks the image in place, permanently. Multiple color printing can be done on the label stock at one time. The product provides the benefits of silk-screening, reverse printed membranes and laser engraved signs and switches without the inflexibility associated with these technologies. Typical applications include rating plates, engraved plastic switches and permanent color coding of wires and panels. |
| RMK-6 | Epoxy coated polyester | -40°C to +105°C | -40°F to +221°F | A specially formulated product for use in the harshest of conditions. Available as die-cut labels, the product is inkjet or dot-matrix printable and when cured with a heat gun post printing, the product has a mark that is indelible. Combined with low fire hazard properties, the product is ideal for use where post-burn exposure to living beings is a real risk. Typical applications include rating plates in electronics and components and pipe and cable wrap around marking where permanent mark is desired. |
| RPS | Radiation cross-linked polyolefin | -30°C to +105°C | -22°F to +221°F | Suitable for applications where permanent identification of wires, cables and harnesses is required and a mil grade material or color coding other than white and yellow is not a necessity. 3:1 shrink ratio, quick-shrink properties and pre-kitted format along with thermal printable characteristics make this product ideal for high-volume applications that are heat-sensitive and withstand harsh environments. |
| TMS-CCUV | Radiation cross-linked fluoropolymer | -55°C to +150°C | -67°F to +302°F | A transparent heat-shrinkable sleeve that complements the entire heat-shrink and cable tag range of Tyco Identification products. Used in combination with any of the sleeve and tag materials, the product provides exceptional UV and weathering resistance where needed and protects the print from being degraded. The product also works with the NBC-SCE material and used along with an NBC adhesive, conforms to the requirements of an NBC system. The product is available in several different sizes and sleeve lengths. Typical industrial applications include chemical plants, healthcare industry, outer space and nuclear plants. The product is also ideal for NBC harnesses in the defense industry. |

continued

Master materials specification cross reference (Cont'd)

Wire, harness and pipe ID (continued)

| Tyco material | Material | Temperature range | | Recommended application |
|---------------|--|-------------------|-----------------|---|
| | | °C | °F | |
| TMS-SCE | Radiation cross-linked polyolefin | -55°C to +135°C | -67°F to +275°F | A heat-shrink identification product that comes in 2:1 and 3:1 shrink ratios and a large range of diameters to fulfill most of the wire and cable identification needs that demand a permanent marker. The product meets and exceeds the performance requirements of the Mil-23053/5 class 1 and 3 and is suitable for a wide range of industry – from aerospace, defense, rail and mass transit to industrial and electronics sectors. The light weight of the product translates into significant savings for the aerospace industry. The product has quick-shrink properties that make it well-suited for applications that are heat-sensitive. The product also comes in all colors to facilitate color coding while identifying. |
| TP | Polyester | -40°C to +163°C | -40°F to +375°F | Suitable for tube and pipe labels in the aerospace/defense industry. Several sizes and standard pre-coded patterns for the various types of fluid/air/gas lines eliminate several steps and complex inventories. Flexible material and ultra-aggressive adhesive conform to curved surfaces with ease. |
| TTP | Polyester | -40°C to +150°C | -40°F to +302°F | The product is an excellent alternative to expensive and in-flexible silk-screen printing. Available in several colors and widths, it is ideal for use as decals requiring excellent resistance to fluids and abrasion and where color printing with variable text is required. Applications include aerospace, defense, rail and mass transit and industrial plants. The product meets print performance requirements of Mil-M-81531. |
| VF | Polyvinyl fluoride (Tedlar®) | -40°C to +130°C | -40°F to +266°F | A label product ideal for use in color coding and identification of wires, wire bundles and cables. The product can also be used in panels and boards. The product has exceptional resistance to burn and has superior UV stability. Available as continuous and die-cut, the product comes in all standard resistor color codes and meets the requirements of several Military and industry standards for wrapping tapes and labels. |
| ZH-SCE | Radiation cross-linked zero-halogen polyolefin | -30°C to 105°C | -22°F to +221°F | A halogen-free product suitable for applications where low-smoke upon combustion is a necessity. The product has superior resistance to common fluids and solvents and is ideal for use in rail and mass transit and industrial applications that involve close contact with humans. The product is available for a wide range of wire and cable diameters and shrinks to half the expanded diameter. |

Industry Icon Key



AEROSPACE



AUTOMOTIVE



CIRCUIT BOARDS



COMPONENTS



ELECTRONICS



GENERAL PURPOSE



INDUSTRIAL



MARINE



MEDICAL



MILITARY



RAIL



SPACE



TELECOM

Part number index

| Part number | Page | Part number | Page | Part number | Page | Part number | Page | Part number | Page | Part number | Page |
|-------------------|------|------------------|------|-----------------|------|-----------------|------|------------------|------|-------------|------|
| 0580 | 59 | A-PV10 | 51 | CP-208086-5-X | 68 | D-SCE-1K-38-50 | 23 | EP-040040-25-9 | 94 | HL104 | 137 |
| 0581 | 59 | A-TW10 | 49 | CP-222159-15-X | 68 | D-SCE-1K-4.8-50 | 23 | EP-044033-10-9 | 94 | HL104 | 137 |
| 0615 | 59 | AM6310-230V | 111 | CP-229064-10-X | 68 | D-SCE-1K-6.4-50 | 23 | EP-064064-25-9 | 94 | HL104 | 137 |
| 0616 | 59 | AM6310D-110V | 111 | CP-250381-10-X | 68 | D-SCE-1K-9.5-50 | 23 | EP-080080-10-9 | 94 | HL104 | 137 |
| 0617 | 59 | AM6310D-230V | 111 | CP-254045-10-X | 68 | D1-PV1 | 51 | EP-089047-10-9 | 94 | HL104 | 137 |
| 0618 | 59 | AM6310-110V | 111 | CP-254064-10-X | 68 | D1-TW1 | 49 | EP-095080-25-9 | 94 | HL104 | 137 |
| 0620 | 59 | C-064064-10-9 | 97 | CP-254097-10-X | 68 | D3-PV1 | 51 | EP-095095-10-9 | 94 | HL104 | 137 |
| 0622 | 59 | C-076191-10-9 | 97 | CP-254127-10-X | 68 | D3-TW1 | 49 | EP-101101-1.3-9 | 94 | HL104 | 137 |
| 0624 | 59 | C-080080-10-9 | 97 | CP-254254-10-9 | 68 | DMVF050 | 180 | EP-101165-0.85-9 | 94 | HL104 | 137 |
| 12510000 | 59 | C-095095-10-9 | 97 | CP-305047-10-X | 68 | DMVF075 | 100 | EP-101508-2.5-9 | 94 | HL104 | 137 |
| 12520000 | 59 | C-115064-10-9 | 97 | CP-318064-10-X | 68 | DMVF100 | 100 | EP-101635-2.5-9 | 94 | HL104 | 137 |
| 12530000 | 59 | C-121064-10-9 | 97 | CP-318097-10-X | 68 | DMVF1029 | 2.5 | EP-101762-1.8-9 | 94 | HL104 | 137 |
| 12540000 | 59 | C-154064-10-9 | 97 | CP-381020-10-X | 68 | DMVF1079 | 1 | EP-114040-25-9 | 94 | HL104 | 137 |
| 12550000 | 59 | C-159079-10-9 | 97 | CP-381064-10-X | 68 | DMVF150 | 100 | EP-127032-10-9 | 94 | HL104 | 137 |
| 12560000 | 59 | C-165051-10-9 | 97 | CP-381127-5-X | 68 | DMVF1529 | 2.5 | EP-127111-10-9 | 94 | HL104 | 137 |
| 1330-0037-00 | 120 | C-191064-10-9 | 97 | CP-381191-5-X | 68 | DMVF1679 | 1 | EP-127127-10-9 | 94 | HL104 | 137 |
| 1330-0600-10 | 116 | C-203127-10-9 | 97 | CP-381381-2.5-X | 68 | DMVF200 | 100 | EP-165051-25-9 | 94 | HL104 | 137 |
| 1330-0607-10 | 115 | C-203365-10-9 | 97 | CP-381635-5-X | 68 | DMVF300 | 100 | EP-165102-10-9 | 94 | HL104 | 137 |
| 1330-0620-10 | 115 | C-215055-10-9 | 97 | CP-406254-1.5-X | 68 | DMVF3015 | 1 | EP-171171-10-9 | 94 | HL104 | 137 |
| 1330-0621-10 | 115 | C-229064-10-9 | 97 | CP-445064-10-X | 68 | DMVF3509 | 2.5 | EP-178095-10-9 | 94 | HL104 | 137 |
| 1330-0622-10 | 115 | C-254095-10-9 | 97 | CP-445102-5-X | 68 | DMVF400 | 100 | EP-191064-10-9 | 94 | HL104 | 137 |
| 1330-0630-10 | 115 | C-254127-10-9 | 97 | CP-445445-2-X | 68 | DMVF6004 | 2.5 | EP-191114-15-9 | 94 | HL104 | 137 |
| 1330-0631-10 | 115 | C-293064-10-9 | 97 | CP-478175-5-X | 68 | E-064064-10-9 | 103 | EP-191762-5-9 | 94 | HL104 | 137 |
| 1330-0632-10 | 115 | C-381064-10-S1-9 | 97 | CP-508064-10-X | 68 | E-076191-10-9 | 103 | EP-203127-10-9 | 94 | HL104 | 137 |
| 1330-3300-10 | 116 | C-394064-10-9 | 97 | CP-508095-5-X | 68 | E-080080-10-9 | 103 | EP-208086-5-9 | 94 | HL104 | 137 |
| 1330-3300-101TT | 117 | C-508095-5-9 | 97 | CP-508127-10-X | 68 | E-095095-10-9 | 103 | EP-222159-15-9 | 94 | HL104 | 137 |
| 1361 | 56 | C-533064-5-9 | 97 | CP-508254-5-X | 68 | E-102070-10-9 | 103 | EP-229064-10-9 | 94 | HL104 | 137 |
| 11320000 | 57 | C-533114-5-9 | 97 | CP-508318-2.5-X | 68 | E-115064-10-9 | 103 | EP-250381-10-9 | 94 | HL104 | 137 |
| 11310000 | 57 | C1-PV2.5 | 51 | CP-508508-3-X | 68 | E-121064-10-9 | 103 | EP-254045-10-9 | 94 | HL104 | 137 |
| 11300000 | 57 | C1-TW2.5 | 49 | CP-523841-1.5-X | 68 | E-127111-10-9 | 103 | EP-254064-10-9 | 94 | HL104 | 137 |
| 11330000 | 57 | CM-SCE-1/2-4H | 7 | CP-610419-2.5-X | 68 | E-127191-10-9 | 103 | EP-254097-10-9 | 94 | HL104 | 137 |
| 1892BK01 | 121 | CM-SCE-1/2-6H | 7 | CP-699191-5-X | 68 | E-154064-10-9 | 103 | EP-254127-10-9 | 94 | HL104 | 137 |
| 1892BK03-RIBBON | 121 | CM-SCE-1/4-4H | 7 | CP-699254-5-X | 68 | E-159079-10-9 | 103 | EP-254254-10-9 | 94 | HL104 | 137 |
| 1892BK04-RIBBON | 121 | CM-SCE-TP-1/4-4H | 7 | CP-762127-1-X | 68 | E-165051-10-9 | 103 | EP-305047-10-9 | 94 | HL104 | 137 |
| 1910-RIBBON-4T300 | 118 | CM-SCE-TP-1/2-4H | 7 | CP-762381-2.5-X | 68 | E-165101-1-9 | 103 | EP-318064-10-9 | 94 | HL104 | 137 |
| 1950-RIBBON-4T300 | 119 | CM-SCE-TP-1/2-6H | 7 | CP-762508-2.5-X | 68 | E-191064-10-9 | 103 | EP-318097-10-9 | 94 | HL104 | 137 |
| 301-LE | 105 | CP-040040-25-X | 68 | CR-100-LSR | 53 | E-203064-10-9 | 103 | EP-381020-10-9 | 94 | HL104 | 137 |
| 301-LM | 105 | CP-044033-10-X | 68 | CR-101-LSR | 53 | E-203127-10-9 | 103 | EP-381064-10-9 | 94 | HL104 | 137 |
| 303-LE | 105 | CP-064064-25-X | 68 | CR-105-LSR | 53 | E-203365-10-9 | 103 | EP-381127-5-9 | 94 | HL104 | 137 |
| 303-LM | 105 | CP-080080-10-X | 68 | CR-106-LSR | 53 | E-215055-10-9 | 103 | EP-381191-5-9 | 94 | HL104 | 137 |
| 304-LE | 105 | CP-089047-10-X | 68 | CR-107-LSR | 53 | E-229064-10-9 | 103 | EP-381381-2.5-9 | 94 | HL104 | 137 |
| 304-LM | 105 | CP-095080-25-X | 68 | CR-108-LSR | 53 | E-254095-10-9 | 103 | EP-381635-5-9 | 94 | HL104 | 137 |
| 305-LE | 105 | CP-095095-10-X | 68 | CR-110-LSR | 53 | E-254127-10-9 | 103 | EP-406254-1.5-9 | 94 | HL104 | 137 |
| 305-LM | 105 | CP-101101-1.3-X | 68 | CWM-SL-# | 63 | E-293064-10-9 | 103 | EP-445064-10-9 | 94 | HL104 | 137 |
| 307-LE | 105 | CP-101165-0.85-X | 68 | CWM-SL-letter | 63 | E-381191-10-9 | 103 | EP-445102-5-9 | 94 | HL104 | 137 |
| 307-LM | 105 | CP-101508-2.5-X | 68 | CWM-SL-color | 63 | E-394064-10-9 | 103 | EP-445445-2-9 | 94 | HL104 | 137 |
| 308-LE | 105 | CP-101635-2.5-X | 68 | CWM-SL-legend | 63 | E-508095-5-9 | 103 | EP-478175-5-9 | 94 | HL104 | 137 |
| 308-LM | 105 | CP-101762-1.8-X | 68 | CWM-SQ-1-33 | 63 | E-508254-4-9 | 103 | EP-508064-10-9 | 94 | HL104 | 137 |
| 309-LE | 105 | CP-114040-25-X | 68 | CWM-SQ-34-66 | 63 | E-508318-3-9 | 103 | EP-508095-5-9 | 94 | HL104 | 137 |
| 309-LM | 105 | CP-127032-10-X | 68 | CWM-SQ-67-99 | 63 | E-533064-5-9 | 103 | EP-508127-10-9 | 94 | HL104 | 137 |
| 310-LE | 105 | CP-127111-10-X | 68 | CWM-SQ-A-Z | 63 | E-533114-5-9 | 103 | EP-508254-5-9 | 94 | HL104 | 137 |
| 310-LM | 105 | CP-127127-10-X | 68 | CWM-SQ-AA-ZZ | 63 | E-572286-2.5-9 | 103 | EP-508318-2.5-9 | 94 | HL104 | 137 |
| 314-LE | 105 | CP-165051-25-X | 68 | CWM-SQ-a-z | 63 | E-673254-3-9 | 103 | EP-508508-3-9 | 94 | HL104 | 137 |
| 314-LM | 105 | CP-165102-10-X | 68 | CWM-SQ-1-6 | 63 | E-673349-3-9 | 103 | EP-523841-1.5-9 | 94 | HL104 | 137 |
| 318-LE | 105 | CP-171171-10-X | 68 | CWM-SQ-1-18 | 63 | E-699254-2.5-9 | 103 | EP-610419-2.5-9 | 94 | HL104 | 137 |
| 318-LM | 105 | CP-178095-10-X | 68 | D-SCE-1K-12-50 | 23 | E-699318-2.5-9 | 103 | EP-699191-5-9 | 94 | HL104 | 137 |
| 319-LE | 105 | CP-191064-10-X | 68 | D-SCE-1K-18-50 | 23 | E-711064-5-9 | 103 | EP-699254-5-9 | 94 | HL104 | 137 |
| 319-LM | 105 | CP-191114-15-X | 68 | D-SCE-1K-2.4-50 | 23 | E-762508-1-9 | 103 | EP-762127-1-9 | 94 | HL104 | 137 |
| 325-LE | 105 | CP-191762-5-X | 68 | D-SCE-1K-25-50 | 23 | E-920254-2.5-9 | 103 | EP-762381-2.5-9 | 94 | HL104 | 137 |
| 325-LM | 105 | CP-203127-10-X | 68 | D-SCE-1K-3.2-50 | 23 | E-920381-2.5-9 | 103 | EP-762508-2.5-9 | 94 | HL104 | 137 |

Part number index (Cont'd)

| Part number | Page | Part number | Page | Part number | Page | Part number | Page | Part number | Page | Part number | Page |
|------------------|------|---------------------------|------|----------------------------|------|-------------------|------|-------------------|------|-------------------|------|
| HM-101635-2.5-8A | 72 | HPKTM1CL-312 | 34 | HW-208086-5-9 | 70 | K-254095-10-1A | 101 | M-159079-10-8A | 99 | MP-254254-10-8A | 74 |
| HM-101762-1.8-8A | 72 | HPKTM1CL-438 | 134 | HW-222159-15-9 | 70 | K-254127-10-1A | 101 | M-165051-10-8A | 99 | MP-305047-10-8A | 74 |
| HM-114040-25-8A | 72 | HPKTM1CL-500 | 134 | HW-229064-10-9 | 70 | K-293064-10-1A | 101 | M-165101-1-8A | 99 | MP-318064-10-8A | 74 |
| HM-127032-10-8A | 72 | HPKTM1CR-312 | 134 | HW-250381-10-9 | 70 | K-508095-5-1A | 101 | M-191064-10-8A | 99 | MP-318097-10-8A | 74 |
| HM-127111-10-8A | 72 | HPKTM1CR-438 | 134 | HW-254045-10-9 | 70 | K-533064-5-1A | 101 | M-203064-10-8A | 99 | MP-381020-10-8A | 74 |
| HM-127127-10-8A | 72 | HPKTM1CR-500 | 134 | HW-254064-10-9 | 70 | KTT-044033-10-1A | 90 | M-203127-10-8A | 99 | MP-381064-10-8A | 74 |
| HM-165051-25-8A | 72 | HPTM1CL-312 | 132 | HW-254097-10-9 | 70 | KTT-064064-25-1A | 90 | M-203365-10-8A | 99 | MP-381127-5-8A | 74 |
| HM-165102-10-8A | 72 | HPTM1CL-438 | 132 | HW-254127-10-9 | 70 | KTT-076191-10-1A | 90 | M-215055-10-8A | 99 | MP-381191-5-8A | 74 |
| HM-171171-10-8A | 72 | HPTM1CL-500 | 132 | HW-254254-10-9 | 70 | KTT-080080-10-1A | 90 | M-229064-10-8A | 99 | MP-381381-2.5-8A | 74 |
| HM-178095-10-8A | 72 | HPTM1CR-312 | 132 | HW-305047-10-9 | 70 | KTT-095080-25-1A | 90 | M-254095-10-8A | 99 | MP-381635-5-8A | 74 |
| HM-191064-10-8A | 72 | HPTM1CR-438 | 132 | HW-318064-10-9 | 70 | KTT-095095-10-1A | 90 | M-254127-10-8A | 99 | MP-406254-1.5-8A | 74 |
| HM-191114-15-8A | 72 | HPTM1CR-500 | 132 | HW-318097-10-9 | 70 | KTT-127032-10-1A | 90 | M-293064-10-8A | 99 | MP-445064-10-8A | 74 |
| HM-191762-5-8A | 72 | HS024-<color...pack size> | 9 | HW-381020-10-9 | 70 | KTT-127111-10-1A | 90 | M-381191-10-8A | 99 | MP-445102-5-8A | 74 |
| HM-203127-10-8A | 72 | HS032-<color...pack size> | 9 | HW-381064-10-9 | 70 | KTT-127127-10-1A | 90 | M-394064-10-8A | 99 | MP-445445-2-8A | 74 |
| HM-208086-5-8A | 72 | HS048-<color...pack size> | 9 | HW-381127-5-9 | 70 | KTT-165051-25-1A | 90 | M-508095-5-8A | 99 | MP-478175-5-8A | 74 |
| HM-222159-15-8A | 72 | HS064-<color...pack size> | 9 | HW-381191-5-9 | 70 | KTT-171171-10-1A | 90 | M-508254-4-8A | 99 | MP-508064-10-8A | 74 |
| HM-229064-10-8A | 72 | HS095-<color...pack size> | 9 | HW-381381-2.5-9 | 70 | KTT-178095-10-1A | 90 | M-508318-3-8A | 99 | MP-508095-5-8A | 74 |
| HM-250381-10-8A | 72 | HS127-<color...pack size> | 9 | HW-381635-5-9 | 70 | KTT-191064-10-1A | 90 | M-533064-5-8A | 99 | MP-508127-10-8A | 74 |
| HM-254045-10-8A | 72 | HS190-<color...pack size> | 9 | HW-406254-1.5-9 | 70 | KTT-191762-5-1A | 90 | M-533114-5-8A | 99 | MP-508254-5-8A | 74 |
| HM-254064-10-8A | 72 | HS254-<color...pack size> | 9 | HW-445064-10-9 | 70 | KTT-229064-10-1A | 90 | M-572286-2.5-8A | 99 | MP-508318-2.5-8A | 74 |
| HM-254097-10-8A | 72 | HS381-<color...pack size> | 9 | HW-445102-5-9 | 70 | KTT-250381-10-1A | 90 | M-673254-3-8A | 99 | MP-508508-3-8A | 74 |
| HM-254127-10-8A | 72 | HT-SCE-1K-1½-2.0-<c...> | 13 | HW-445445-2-9 | 70 | KTT-254045-10-1A | 90 | M-673349-3-8A | 99 | MP-523841-1.5-8A | 74 |
| HM-254254-10-8A | 72 | HT-SCE-1K-1-2.0-<color> | 13 | HW-478175-5-9 | 70 | KTT-254064-10-1A | 90 | M-699254-2.5-8A | 99 | MP-610419-2.5-8A | 74 |
| HM-305047-10-8A | 72 | HT-SCE-1K-¾-2.0-<color> | 13 | HW-508064-10-9 | 70 | KTT-254097-10-1A | 90 | M-699318-2.5-8A | 99 | MP-699191-5-8A | 74 |
| HM-318064-10-8A | 72 | HT-SCE-1K-¼-2.0-<color> | 13 | HW-508095-5-9 | 70 | KTT-254127-10-1A | 90 | M-711064-5-8A | 99 | MP-699254-5-8A | 74 |
| HM-318097-10-8A | 72 | HT-SCE-1K-½-2.0-<color> | 13 | HW-508127-10-9 | 70 | KTT-254254-10-1A | 90 | M-762508-1-8A | 99 | MP-762127-1-8A | 74 |
| HM-381020-10-8A | 72 | HT-SCE-1K-⅙-2.0-<color> | 13 | HW-508254-5-9 | 70 | KTT-305047-10-1A | 90 | M-920254-2.5-8A | 99 | MP-762381-2.5-8A | 74 |
| HM-381064-10-8A | 72 | HT-SCE-1K-⅓-2.0-<color> | 13 | HW-508318-2.5-9 | 70 | KTT-318064-10-1A | 90 | M-920381-2.5-8A | 99 | MP-762508-2.5-8A | 74 |
| HM-381127-5-8A | 72 | HT-SCE-1K-¼-2.0-<color> | 13 | HW-508508-3-9 | 70 | KTT-381020-10-1A | 90 | MP-040040-25-8A | 74 | MV-040040-25-8A | 76 |
| HM-381191-5-8A | 72 | HT-SCE-1K-½-2.0-<color> | 13 | HW-523841-1.5-9 | 70 | KTT-381064-10-1A | 90 | MP-044033-10-8A | 74 | MP-044033-10-8A | 76 |
| HM-381381-2.5-8A | 72 | HTCM-SCE-¼-4H-<color> | 15 | HW-610419-2.5-9 | 70 | KTT-381127-5-1A | 90 | MP-064064-25-8A | 74 | MV-064064-25-8A | 76 |
| HM-381635-5-8A | 72 | HTCM-SCE-½-6H-<color> | 15 | HW-699191-5-9 | 70 | KTT-381381-2.5-1A | 90 | MP-080080-10-8A | 74 | MV-080080-10-8A | 76 |
| HM-406254-1.5-8A | 72 | HTCM-SCE-¾-4H-<color> | 15 | HW-699254-5-9 | 70 | KTT-381635-5-1A | 90 | MP-089047-10-8A | 74 | MV-089047-10-8A | 76 |
| HM-445064-10-8A | 72 | HTCM-SCE-TP-¼-4H-<c...> | 15 | HW-762127-1-9 | 70 | KTT-445064-10-1A | 90 | MP-095080-25-8A | 74 | MV-095080-25-8A | 76 |
| HM-445102-5-8A | 72 | HTCM-SCE-TP-½-4H-<c...> | 15 | HW-762381-2.5-9 | 70 | KTT-445102-5-1A | 90 | MP-095095-10-8A | 74 | MV-095095-10-8A | 76 |
| HM-445445-2-8A | 72 | HTCM-SCE-TP-¾-6H-<c...> | 15 | HW-762508-2.5-9 | 70 | KTT-445445-2-1A | 90 | MP-101101-1.3-8A | 74 | MP-101101-1.3-8A | 76 |
| HM-478175-5-8A | 72 | HW-040040-25-9 | 70 | HX-032-<color...pack size> | 18 | KTT-508064-10-1A | 90 | MP-101165-0.85-8A | 74 | MV-101165-0.85-8A | 76 |
| HM-508064-10-8A | 72 | HW-044033-10-9 | 70 | HX-048-<color...pack size> | 18 | KTT-508095-5-1A | 90 | MP-101508-2.5-8A | 74 | MV-101508-2.5-8A | 76 |
| HM-508095-5-8A | 72 | HW-064064-25-9 | 70 | HX-064-<color...pack size> | 18 | KTT-508127-10-1A | 90 | MP-101635-2.5-8A | 74 | MV-101635-2.5-8A | 76 |
| HM-508127-10-8A | 72 | HW-080080-10-9 | 70 | HX-095-<color...pack size> | 18 | KTT-508508-3-1A | 90 | MP-101762-1.8-8A | 74 | MV-101762-1.8-8A | 76 |
| HM-508254-5-8A | 72 | HW-089047-10-9 | 70 | HX-127-<color...pack size> | 18 | KTT-523841-1.5-1A | 90 | MP-114040-25-8A | 74 | MV-114040-25-8A | 76 |
| HM-508318-2.5-8A | 72 | HW-095080-25-9 | 70 | HX-190-<color...pack size> | 18 | LEB2-0615P | 105 | MP-127032-10-8A | 74 | MP-127032-10-8A | 76 |
| HM-508508-3-8A | 72 | HW-095095-10-9 | 70 | HX-254-<color...pack size> | 18 | LEB2-0818P | 105 | MP-127111-10-8A | 74 | MV-127111-10-8A | 76 |
| HM-523841-1.5-8A | 72 | HW-101101-1.3-9 | 70 | HX-381-<color...size> | 18 | LEB2-0820P | 105 | MP-127127-10-8A | 74 | MV-127127-10-8A | 76 |
| HM-610419-2.5-8A | 72 | HW-101165-0.85-9 | 70 | J-PV10 | 51 | LEB2-0825P | 105 | MP-165051-25-8A | 74 | MV-165051-25-8A | 76 |
| HM-699191-5-8A | 72 | HW-101508-2.5-9 | 70 | J-TW10 | 49 | LEB2-0916P | 105 | MP-165102-10-8A | 74 | MV-165102-10-8A | 76 |
| HM-699254-5-8A | 72 | HW-101635-2.5-9 | 70 | K-064064-10-1A | 101 | LEB2-0920P | 105 | MP-171171-10-8A | 74 | MV-171171-10-8A | 76 |
| HM-762127-1-8A | 72 | HW-101762-1.8-9 | 70 | K-076191-10-1A | 101 | LEB2-1318P | 105 | MP-178095-10-8A | 74 | MV-178095-10-8A | 76 |
| HM-762381-2.5-8A | 72 | HW-114040-25-9 | 70 | K-080080-10-1A | 101 | LEB2-1325P | 105 | MP-191064-10-8A | 74 | MV-191064-10-8A | 76 |
| HM-762508-2.5-8A | 72 | HW-127032-10-9 | 70 | K-095095-10-1A | 101 | LMS-9000 | 113 | MP-191114-15-8A | 74 | MV-191114-15-8A | 76 |
| HPC02WE1050 | 43 | HW-127111-10-9 | 70 | K-115064-10-1A | 101 | M-064064-10-8A | 99 | MP-191762-5-8A | 74 | MV-191762-5-8A | 76 |
| HPC04WE1050 | 43 | HW-127127-10-9 | 70 | K-121064-10-1A | 101 | M-076191-10-8A | 99 | MP-203127-10-8A | 74 | MV-203127-10-8A | 76 |
| HPC06WE1050 | 43 | HW-165051-25-9 | 70 | K-154064-10-1A | 101 | M-080080-10-8A | 99 | MP-208086-5-8A | 74 | MV-208086-5-8A | 76 |
| HPC08WE1050 | 43 | HW-165102-10-9 | 70 | K-159079-10-1A | 101 | M-095095-10-8A | 99 | MP-222159-15-8A | 74 | MV-222159-15-8A | 76 |
| HPC10WE1050 | 43 | HW-171171-10-9 | 70 | K-165051-10-1A | 101 | M-102070-10-8A | 99 | MP-229064-10-8A | 74 | MV-229064-10-8A | 76 |
| HPK02WE1050 | 41 | HW-178095-10-9 | 70 | K-191064-10-1A | 101 | M-115064-10-8A | 99 | MP-250381-10-8A | 74 | MV-250381-10-8A | 76 |
| HPK04WE1050 | 41 | HW-191064-10-9 | 70 | K-203127-10-1A | 101 | M-121064-10-8A | 99 | MP-254045-10-8A | 74 | MV-254045-10-8A | 76 |
| HPK06WE1050 | 41 | HW-191114-15-9 | 70 | K-203365-10-1A | 101 | M-127111-10-8A | 99 | MP-254064-10-8A | 74 | MV-254064-10-8A | 76 |
| HPK08WE1050 | 41 | HW-191762-5-9 | 70 | K-215055-10-1A | 101 | M-127191-10-8A | 99 | MP-254097-10-8A | 74 | MV-254097-10-8A | 76 |
| HPK10WE1050 | 41 | HW-203127-10-9 | 70 | K-229064-10-1A | 101 | M-154064-10-8A | 99 | MP-254127-10-8A | 74 | MV-254127-10-8A | 76 |

Part number index (Cont'd)

| Part number | Page | Part number | Page | Part number | Page | Part number | Page | Part number | Page | Part number | Page |
|-------------------------|------|--------------------|------|------------------|------|---------------------------|------|------------------|------|--------------------|------|
| MV-254254-10-8A | 76 | NC-381064-10-S1-9 | 82 | PVF-254254-10-9 | 92 | RMK-50x13-A4 | 37 | T-TW2.5 | 49 | T2K-254127-10-9 | 86 |
| MV-305047-10-8A | 76 | NC-381127-5-9 | 82 | PVF-305047-10-9 | 92 | RMK-50x25-A4 | 37 | T1K-044033-10-9 | 84 | T2K-254254-10-9 | 86 |
| MV-318064-10-8A | 76 | NC-381381-2.5-9 | 82 | PVF-318064-10-9 | 92 | RMK-50x100-A4 | 37 | T1K-064064-25-9 | 84 | T2K-305047-10-9 | 86 |
| MV-318097-10-8A | 76 | NC-381635-5-9 | 82 | PVF-318097-10-9 | 92 | RMK-75-150-A4 | 37 | T1K-076191-10-9 | 84 | T2K-318064-10-9 | 86 |
| MV-381020-10-8A | 76 | NC-445064-10-9 | 82 | PVF-381020-10-9 | 92 | RMK-87x13-A4 | 37 | T1K-080080-10-9 | 84 | T2K-381020-10-9 | 86 |
| MV-381064-10-8A | 76 | NC-445102-5-9 | 82 | PVF-381064-10-9 | 92 | RMK-87x25-A4 | 37 | T1K-095080-25-9 | 84 | T2K-381064-10-9 | 86 |
| MV-381127-5-8A | 76 | NC-445445-2-9 | 82 | PVF-381127-5-9 | 92 | RMK-150x150-A4 | 37 | T1K-095095-10-9 | 84 | T2K-381127-5-9 | 86 |
| MV-381191-5-8A | 76 | NC-508064-10-9 | 82 | PVF-381191-5-9 | 92 | RMK-170x13-A4 | 37 | T1K-127032-10-9 | 84 | T2K-381381-2.5-9 | 86 |
| MV-381381-2.5-8A | 76 | NC-508095-5-9 | 82 | PVF-381381-2.5-9 | 92 | RMK-170x25-A4 | 37 | T1K-127111-10-9 | 84 | T2K-381635-5-9 | 86 |
| MV-381635-5-8A | 76 | NC-508127-10-9 | 82 | PVF-381635-5-9 | 92 | RMK-190x30-A4 | 37 | T1K-127127-10-9 | 84 | T2K-445064-10-9 | 86 |
| MV-406254-1.5-8A | 76 | NC-508508-3-9 | 82 | PVF-406254-1.5-9 | 92 | RMK-200x13-A4 | 37 | T1K-165051-25-9 | 84 | T2K-445102-5-9 | 86 |
| MV-445064-10-8A | 76 | NC-523841-1.5-9 | 82 | PVF-445064-10-9 | 92 | RMK-250x13-A4 | 37 | T1K-171171-10-9 | 84 | T2K-445445-2-9 | 86 |
| MV-445102-5-8A | 76 | NMX25625<color>2.5 | 25 | PVF-445102-5-9 | 92 | RMK-250x25-A4 | 37 | T1K-178095-10-9 | 84 | T2K-508064-10-9 | 86 |
| MV-445445-2-8A | 76 | NPVF050XX-100 | 33 | PVF-445445-2-9 | 92 | RMK-9x25.A4 | 37 | T1K-191064-10-9 | 84 | T2K-508095-5-9 | 86 |
| MV-478175-5-8A | 76 | NPVF150CL-100 | 33 | PVF-478175-5-9 | 92 | RMK-UNCUT-44 | 37 | T1K-191762-5-9 | 84 | T2K-508127-10-9 | 86 |
| MV-508064-10-8A | 76 | NPVF200CL-100 | 33 | PVF-508064-10-9 | 92 | RMK6-12.7 | 34 | T1K-229064-10-9 | 84 | T2K-508508-3-9 | 86 |
| MV-508095-5-8A | 76 | NPVF300CL-100 | 33 | PVF-508095-5-9 | 92 | RMK6-17.0 | 34 | T1K-250381-10-9 | 84 | T2K-523841-1.5-9 | 86 |
| MV-508127-10-8A | 76 | NPVF400CL-100 | 33 | PVF-508127-10-9 | 92 | RMK6-25.4 | 34 | T1K-254045-10-9 | 84 | T2K-523841-3-9 | 89 |
| MV-508254-5-8A | 76 | O-PV10 | 51 | PVF-508254-5-9 | 92 | RMK6-4.2 | 34 | T1K-254064-10-9 | 84 | T2Y-064064-25-9 | 89 |
| MV-508318-2.5-8A | 76 | O-TW10 | 49 | PVF-508318-2.5-9 | 92 | RMK6-55.0 | 34 | T1K-254097-10-9 | 84 | T2Y-076191-10-9 | 89 |
| MV-508508-3-8A | 76 | P-PV5 | 51 | PVF-508508-3-9 | 92 | RMK6-8.5 | 34 | T1K-254127-10-9 | 84 | T2Y-080080-10-9 | 89 |
| MV-523841-1.5-8A | 76 | P-TW5 | 49 | PVF-523841-1.5-9 | 92 | RMK6-WM | 34 | T1K-254254-10-9 | 84 | T2Y-095080-25-9 | 89 |
| MV-610419-2.5-8A | 76 | PM07507-1- | 131 | PVF-610419-2.5-9 | 92 | RPS-1K-1-400/2.0<color> | 26 | T1K-305047-10-9 | 84 | T2Y-095095-10-9 | 89 |
| MV-699191-5-8A | 76 | PM09512-<lines> | 131 | PVF-699191-5-9 | 92 | RPS-1K-10-2/2.0<color> | 26 | T1K-318064-10-9 | 84 | T2Y-127032-10-9 | 89 |
| MV-699254-5-8A | 76 | Pre-Print | 129 | PVF-699254-5-9 | 92 | RPS-1K-16-10/2.0<color> | 26 | T1K-381020-10-9 | 84 | T2Y-127111-10-9 | 89 |
| MV-762127-1-8A | 76 | PRINT-EASY-PRO | 125 | PVF-762127-1-9 | 92 | RPS-1K-18-12/2.0<color> | 26 | T1K-381064-10-9 | 84 | T2Y-127127-10-9 | 89 |
| MV-762381-2.5-8A | 76 | PRINT-EASY-SUITE | 125 | PVF-762381-2.5-9 | 92 | RPS-1K-22-18/2.0<color> | 26 | T1K-381127-5-9 | 84 | T2Y-165051-25-9 | 89 |
| MV-762508-2.5-8A | 76 | PRINT-EASY-NET05 | 125 | PVF-762508-2.5-9 | 92 | RPS-1K-400-1000/2.0<c...> | 26 | T1K-381381-2.5-9 | 84 | T2Y-171171-10-9 | 89 |
| N-PV10 | 51 | PVF-040040-25-9 | 92 | PVF050100WE10 | 46 | RPS-1K-6-250/2.0<color> | 26 | T1K-381635-5-9 | 84 | T2Y-178095-10-9 | 89 |
| N-TW10 | 49 | PVF-044033-10-9 | 92 | PVF050143WE10 | 46 | RPS-1K-8-4/2.0<color> | 26 | T1K-445064-10-9 | 84 | T2Y-191064-10-9 | 89 |
| NBC-SCE-1K-1½-2.0<c...> | 28 | PVF-064064-25-9 | 92 | PVF080150WE10 | 46 | S-PV2.5 | 51 | T1K-445102-5-9 | 84 | T2Y-191762-5-9 | 89 |
| NBC-SCE-1K-1-2.0<c...> | 28 | PVF-080080-10-9 | 92 | PVF100143WE5 | 46 | S-TW2.5 | 49 | T1K-445445-2-9 | 84 | T2Y-229064-10-9 | 89 |
| NBC-SCE-1K-½-2.0<c...> | 28 | PVF-089047-10-9 | 92 | PVF100225WE5 | 46 | SB050100WE10 | 44 | T1K-508064-10-9 | 84 | T2Y-250381-10-9 | 89 |
| NBC-SCE-1K-¼-2.0<c...> | 28 | PVF-095080-25-9 | 92 | PVF100375WE2.5 | 46 | SB050143WE10 | 44 | T1K-508095-5-9 | 84 | T2Y-254045-10-9 | 89 |
| NBC-SCE-1K-¼-2.0<c...> | 28 | PVF-095095-10-9 | 92 | PVF100594WE1 | 46 | SB075094WE10 | 44 | T1K-508127-10-9 | 84 | T2Y-254064-10-9 | 89 |
| NBC-SCE-1K-¼-2.0<c...> | 28 | PVF-101101-1.3-9 | 92 | PVF100743WE1 | 46 | SB080150WE10 | 44 | T1K-508508-3-9 | 84 | T2Y-254097-10-9 | 89 |
| NC-044033-10-9 | 82 | PVF-101165-0.85-9 | 92 | PVF190319WE2.5 | 46 | SB100143WE5 | 44 | T1K-523841-1.5-9 | 84 | T2Y-254127-10-9 | 89 |
| NC-064064-25-9 | 82 | PVF-101508-2.5-9 | 92 | PVF190594WE1 | 46 | SB100225WE5 | 44 | T208M-PRINTER | 107 | T2Y-254254-10-9 | 89 |
| NC-076191-10-9 | 82 | PVF-101635-2.5-9 | 92 | PVF200143WE2.5 | 46 | SB100375WE2.5 | 44 | T208M-C-PRINTER | 107 | T2Y-305047-10-9 | 89 |
| NC-080080-10-9 | 82 | PVF-101762-1.8-9 | 92 | PVF200225WE2.5 | 46 | SB100594WE1 | 44 | T212M-PRINTER | 107 | T2Y-318064-10-9 | 89 |
| NC-095080-25-9 | 82 | PVF-114040-25-9 | 92 | PVF200375WE2.5 | 46 | SB100743WE1 | 44 | T212M-C-PRINTER | 107 | T2Y-381020-10-9 | 89 |
| NC-095095-10-9 | 82 | PVF-127032-10-9 | 92 | PVF200743WE1 | 46 | SB190319WE2.5 | 44 | T2K-044033-10-9 | 86 | T2Y-381064-10-9 | 89 |
| NC-127032-10-9 | 82 | PVF-127111-10-9 | 92 | Q-PV10 | 51 | SB190594WE1 | 44 | T2K-064064-25-9 | 86 | T2Y-381127-5-9 | 89 |
| NC-127111-10-9 | 82 | PVF-127127-10-9 | 92 | Q-TW10 | 49 | SB200143WE2.5 | 44 | T2K-076191-10-9 | 86 | T2Y-381381-2.5-9 | 89 |
| NC-127127-10-9 | 82 | PVF-165051-25-9 | 92 | R-PV5 | 51 | SB200225WE2.5 | 44 | T2K-080080-10-9 | 86 | T2Y-381635-5-9 | 89 |
| NC-165051-25-9 | 82 | PVF-165102-10-9 | 92 | R-TW5 | 49 | SB200375WE2.5 | 44 | T2K-095080-25-9 | 86 | T2Y-445064-10-9 | 89 |
| NC-178095-10-9 | 82 | PVF-171171-10-9 | 92 | RMK-10x19-A4 | 37 | SB200743WE1 | 44 | T2K-095095-10-9 | 86 | T2Y-445102-5-9 | 89 |
| NC-191064-10-9 | 82 | PVF-178095-10-9 | 92 | RMK-11x40-A4 | 37 | SBH100375WE2.5 | 44 | T2K-127032-10-9 | 86 | T2Y-445445-2-9 | 89 |
| NC-191762-5-9 | 82 | PVF-191064-10-9 | 92 | RMK-18x20-A4 | 37 | STD01 | 61 | T2K-127111-10-9 | 86 | T2Y-508064-10-9 | 89 |
| NC-229064-10-9 | 82 | PVF-191114-15-9 | 92 | RMK-18x25-A4 | 37 | STD02 | 61 | T2K-127127-10-9 | 86 | T2Y-508095-5-9 | 89 |
| NC-250381-10-9 | 82 | PVF-191762-5-9 | 92 | RMK-18x35-A4 | 37 | STD03 | 61 | T2K-165051-25-9 | 86 | T2Y-508127-10-9 | 89 |
| NC-254045-10-9 | 82 | PVF-203127-10-9 | 82 | RMK-18x50-A4 | 37 | STD06 | 61 | T2K-171171-10-9 | 86 | T2Y-508508-3-9 | 89 |
| NC-254064-10-9 | 82 | PVF-208086-5-9 | 92 | RMK-25x30-A4 | 37 | STD08 | 61 | T2K-178095-10-9 | 86 | T2Y-523841-1.5-9 | 89 |
| NC-254097-10-9 | 82 | PVF-222159-15-9 | 92 | RMK-25x35-A4 | 37 | STD12 | 61 | T2K-191064-10-9 | 86 | T200-RIBBON-WH-4HT | 115 |
| NC-254127-10-9 | 82 | PVF-229064-10-9 | 92 | RMK-25x100-A4 | 37 | STD15 | 61 | T2K-191762-5-9 | 86 | T200-RIBBON-4ZH | 119 |
| NC-254254-10-9 | 82 | PVF-250381-10-9 | 92 | RMK-25x50-A4 | 37 | STD15 | 61 | T2K-229064-10-9 | 86 | T300-RIBBON-WH | 114 |
| NC-305047-10-9 | 82 | PVF-254045-10-9 | 92 | RMK-25x75-A4 | 37 | STD17 | 61 | T2K-250381-10-9 | 86 | T300-RIBBON-WH-4HT | 114 |
| NC-318064-10-9 | 82 | PVF-254064-10-9 | 92 | RMK-28x40-A4 | 37 | STD21 | 61 | T2K-254045-10-9 | 86 | T308S-PRINTER | 108 |
| NC-381020-10-9 | 82 | PVF-254097-10-9 | 92 | RMK-30x13-A4 | 37 | STD24 | 61 | T2K-254064-10-9 | 86 | T308S-N-PRINTER | 108 |
| NC-381064-10-9 | 82 | PVF-254127-10-9 | 92 | RMK-35x75-A4 | 37 | T-PV2.5 | 51 | T2K-254097-10-9 | 86 | T308S-C-PRINTER | 108 |

Part number index (Cont'd)

| Part number | Page | Part number | Page | Part number | Page | Part number | Page | Part number | Page | Part number | Page |
|------------------------|------|----------------------------|------|----------------------|------|---------------------|------|------------------|------|-------------------------|------|
| T308S-R-PRINTER | 108 | TMS-CCUV-SLEEVE-3-... | 30 | TN-254045-10-9 | 78 | TSK-191064-10-9 | 88 | WP-114040-25-9 | 66 | WW-127032-10-9 | 80 |
| T312M-PRINTER | 108 | TMS-CCUV-SLEEVE-4-... | 30 | TN-254064-10-9 | 78 | TSK-191762-5-9 | 88 | WP-127032-10-9 | 66 | WW-127111-10-9 | 80 |
| T312M-R-PRINTER | 108 | TMS-CCUV-SLEEVE-5-... | 30 | TN-254097-10-9 | 78 | TSK-229064-10-9 | 88 | WP-127111-10-9 | 66 | WW-127127-10-9 | 80 |
| T312S-PRINTER | 108 | TMS-CCUV-SLEEVE-6-... | 30 | TN-254127-10-9 | 78 | TSK-250381-10-9 | 88 | WP-127127-10-9 | 66 | WW-165051-25-9 | 80 |
| T312S-C-PRINTER | 108 | TMS-CCUV-SLEEVE-7-... | 30 | TN-254254-10-9 | 78 | TSK-254045-10-9 | 88 | WP-165051-25-9 | 66 | WW-165102-10-9 | 80 |
| T312S-R-PRINTER | 108 | TMS-CCUV-SLEEVE-8-... | 30 | TN-305047-10-9 | 78 | TSK-254064-10-9 | 88 | WP-165102-10-9 | 66 | WW-171171-10-9 | 80 |
| T408M-PRINTER | 109 | TMS-CCUV-SLEEVE-9-... | 30 | TN-318064-10-9 | 78 | TSK-254097-10-9 | 88 | WP-171171-10-9 | 66 | WW-178095-10-9 | 80 |
| T408M-R-PRINTER | 109 | TMS-101-RIB...-WH-SCE | 118 | TN-318097-10-9 | 78 | TSK-254127-10-9 | 88 | WP-178095-10-9 | 66 | WW-191064-10-9 | 80 |
| T612M-DS-PRINTER | 110 | TMS-RJS-RIBBON-4HT | 117 | TN-381020-10-9 | 78 | TSK-254254-10-9 | 88 | WP-191064-10-9 | 66 | WW-191114-15-9 | 80 |
| TAK-044033-10-3A | 87 | TMS-RJS-R...-4RPSCE | 117 | TN-381064-10-9 | 78 | TSK-305047-10-9 | 88 | WP-191114-15-9 | 66 | WW-191762-5-9 | 80 |
| TAK-064064-25-3A | 87 | TMS-RJS-RIBBON-4ZH | 118 | TN-381127-5-9 | 78 | TSK-318064-10-9 | 88 | WP-191762-5-9 | 66 | WW-203127-10-9 | 80 |
| TAK-076191-10-3A | 87 | TMS-SCE-1K-1½-2.0-<c...> | 4 | TN-381191-5-9 | 78 | TSK-381020-10-9 | 88 | WP-203127-10-9 | 66 | WW-208086-5-9 | 80 |
| TAK-080080-10-3A | 87 | TMS-SCE-1K-1-2.0-<c...> | 4 | TN-381381-2.5-9 | 78 | TSK-381064-10-9 | 88 | WP-208086-5-9 | 66 | WW-222159-15-9 | 80 |
| TAK-095080-25-3A | 87 | TMS-SCE-1K-½-2.0-<c...> | 4 | TN-381635-5-9 | 78 | TSK-381127-5-9 | 88 | WP-222159-15-9 | 66 | WW-229064-10-9 | 80 |
| TAK-095095-10-3A | 87 | TMS-SCE-1K-¾-2.0-<c...> | 4 | TN-406254-1.5-9 | 78 | TSK-381381-2.5-9 | 88 | WP-229064-10-9 | 66 | WW-250381-10-9 | 80 |
| TAK-127032-10-3A | 87 | TMS-SCE-1K-¾-2.0-<c...> | 4 | TN-445064-10-9 | 78 | TSK-381635-5-9 | 88 | WP-250381-10-9 | 66 | WW-254045-10-9 | 80 |
| TAK-127111-10-3A | 87 | TMS-SCE-1K-2½-2.0-<c...> | 4 | TN-445102-5-9 | 78 | TSK-445064-10-9 | 88 | WP-254045-10-9 | 66 | WW-254064-10-9 | 80 |
| TAK-127127-10-3A | 87 | TMS-SCE-1K-2-2.0-<c...> | 4 | TN-445445-2-9 | 78 | TSK-445102-5-9 | 88 | WP-254064-10-9 | 66 | WW-254097-10-9 | 80 |
| TAK-165051-25-3A | 87 | TMS-SCE-1K-¾-2.0-<c...> | 4 | TN-478175-5-9 | 78 | TSK-445445-2-9 | 88 | WP-254097-10-9 | 66 | WW-254127-10-9 | 80 |
| TAK-171171-10-3A | 87 | TMS-SCE-1K-¾-2.0-<c...> | 4 | TN-508064-10-9 | 78 | TSK-508064-10-9 | 88 | WP-254127-10-9 | 66 | WW-254254-10-9 | 80 |
| TAK-178095-10-3A | 87 | TMS-SCE-1K-¾-2.0-<c...> | 4 | TN-508095-5-9 | 78 | TSK-508095-5-9 | 88 | WP-254254-10-9 | 66 | WW-305047-10-9 | 80 |
| TAK-191064-10-3A | 87 | TMS-SCE-1K-¾-2.0-<c...> | 4 | TN-508127-10-9 | 78 | TSK-508127-10-9 | 88 | WP-305047-10-9 | 66 | WW-318064-10-9 | 80 |
| TAK-191762-5-3A | 87 | TMS-SCE-2X-1K-½-2.0-<c...> | 4 | TN-508254-5-9 | 78 | TSK-508508-3-9 | 88 | WP-318064-10-9 | 66 | WW-318097-10-9 | 80 |
| TAK-229064-10-3A | 87 | TMS-SCE-2X-1K-¾-2.0-<c...> | 4 | TN-508318-2.5-9 | 78 | TSK-523841-1.5-9 | 88 | WP-318097-10-9 | 66 | WW-381020-10-9 | 80 |
| TAK-250381-10-3A | 87 | TMS-SCE-2X-1K-¾-2.0-<c...> | 4 | TN-508508-3-9 | 78 | TTP200<color>-10 | 38 | WP-381020-10-9 | 66 | WW-381064-10-9 | 80 |
| TAK-254045-10-3A | 87 | TMS-SCE-2X-1K-¾-2.0-<c...> | 4 | TN-523841-1.5-9 | 78 | TTP300<color>-10 | 38 | WP-381064-10-9 | 66 | WW-381127-5-9 | 80 |
| TAK-254064-10-3A | 87 | TMS-SCE-2X-1K-¾-2.0-<c...> | 4 | TN-610419-2.5-9 | 78 | TTP400<color>-10 | 38 | WP-381127-5-9 | 66 | WW-381191-5-9 | 80 |
| TAK-254097-10-3A | 87 | TMS-SCE-2X-1K-¾-2.0-<c...> | 4 | TN-699191-5-9 | 78 | TTP600<color>-10 | 38 | WP-381191-5-9 | 66 | WW-381381-2.5-9 | 80 |
| TAK-254127-10-3A | 87 | TMS-SCE-2X-1K-¾-2.0-<c...> | 4 | TN-699254-5-9 | 78 | TTVF050<color>-180 | 32 | WP-381381-2.5-9 | 66 | WW-445064-10-9 | 80 |
| TAK-254254-10-3A | 87 | TMS-SIX-PRXM-PR1... | 112 | TN-762127-1-9 | 78 | TTVF075<color>-100 | 32 | WP-381635-5-9 | 66 | WW-445102-5-9 | 80 |
| TAK-305047-10-3A | 87 | TMS-SYSTEM-SIX-R... | 120 | TN-762381-2.5-9 | 78 | TTVF100<color>-100 | 32 | P-406254-1.5-9 | 66 | WW-445445-2-9 | 80 |
| TAK-318064-10-3A | 87 | TMS-WINTOTAL-SW... | 122 | TN-762508-2.5-9 | 78 | TTVF1029<color>-2.5 | 32 | WP-445064-10-9 | 66 | WW-478175-5-9 | 80 |
| TAK-381020-10-3A | 87 | TN-040040-25-9 | 78 | TP<f...>(XXXX)-0.188 | 138 | TTVF1079<color>-1 | 32 | WP-445102-5-9 | 66 | WW-508064-10-9 | 80 |
| TAK-381064-10-3A | 87 | TN-044033-10-9 | 78 | TP<f...>(XXXX)-0.250 | 138 | TTVF150<color>-100 | 32 | WP-445445-2-9 | 66 | WW-508095-5-9 | 80 |
| TAK-381127-5-3A | 87 | TN-064064-25-9 | 78 | TP<f...>(XXXX)-0.312 | 138 | TTVF1529<color>-2.5 | 32 | WP-478175-5-9 | 66 | WW-508127-10-9 | 80 |
| TAK-381381-2.5-3A | 87 | TN-080080-10-9 | 78 | TP<f...>(XXXX)-0.375 | 138 | TTVF1679<color>-1 | 32 | WP-508064-10-9 | 66 | WW-508254-5-9 | 80 |
| TAK-381635-5-3A | 87 | TN-089047-10-9 | 78 | TP<f...>(XXXX)-0.500 | 138 | TTVF200<color>-100 | 32 | WP-508095-5-9 | 66 | WW-508318-2.5-9 | 80 |
| TAK-445064-10-3A | 87 | TN-095080-25-9 | 78 | TP<f...>(XXXX)-0.625 | 138 | TTVF300<color>-100 | 32 | WP-508127-10-9 | 66 | WW-508508-3-9 | 80 |
| TAK-445102-5-3A | 87 | TN-095095-10-9 | 78 | TP<f...>(XXXX)-0.750 | 138 | TTVF3015<color>-1 | 32 | WP-508254-5-9 | 66 | WW-523841-1.5-9 | 80 |
| TAK-445445-2-3A | 87 | TN-101101-1.3-9 | 78 | TP<f...>(XXXX)-0.875 | 138 | TTVF3509<color>-2.5 | 32 | WP-508318-2.5-9 | 66 | WW-610419-2.5-9 | 80 |
| TAK-508064-10-3A | 87 | TN-101165-0.85-9 | 78 | TP<f...>(XXXX)-1.000 | 138 | TTVF400<color>-100 | 32 | WP-508508-3-9 | 66 | WW-699191-5-9 | 80 |
| TAK-508095-5-3A | 87 | TN-101508-2.5-9 | 78 | TP<f...>(XXXX)-1.125 | 138 | TTVF6004<color>-2.5 | 32 | WP-523841-1.5-9 | 66 | WW-699254-5-9 | 80 |
| TAK-508127-10-3A | 87 | TN-101635-2.5-9 | 78 | TP<f...>(XXXX)-1.250 | 138 | U-PV2.5 | 51 | WP-610419-2.5-9 | 66 | WW-762127-1-9 | 80 |
| TAK-508508-3-3A | 87 | TN-101762-1.8-9 | 78 | TP<f...>(XXXX)-1.375 | 138 | U-TW2.5 | 49 | WP-699191-5-9 | 66 | WW-762381-2.5-9 | 80 |
| TAK-523841-1.5-3A | 87 | TN-114040-25-9 | 78 | TP<f...>(XXXX)-1.500 | 138 | W1-PV1 | 51 | WP-699254-5-9 | 66 | WW-762508-2.5-9 | 80 |
| TMS-101-RIBBON-4HT | 118 | TN-127032-10-9 | 78 | TP<f...>(XXXX)-1.625 | 138 | W1-TW1 | 49 | WP-762127-1-9 | 66 | ZH-SCE-1K-1½-2.0-<c...> | 16 |
| TMS-101-R...-4RPSCE | 117 | TN-127111-10-9 | 78 | TP<f...>(XXXX)-1.750 | 138 | W2-PV1 | 51 | WP-762381-2.5-9 | 66 | ZH-SCE-1K-1-2.0-<color> | 16 |
| TMS-101-RIBBON-4ZH | 118 | TN-127127-10-9 | 78 | TP<f...>(XXXX)-CONT | 138 | W2-TW1 | 49 | WP-762508-2.5-9 | 66 | WP-762508-2.5-9 | 66 |
| TMS-743-EP-LQ870-P... | 110 | TN-165051-25-9 | 78 | TSK-044033-10-9 | 88 | WP-040040-25-9 | 66 | WW-040040-25-9 | 80 | ZH-SCE-1K-½-2.0-<color> | 16 |
| TMS-CCUV-SLEEVE-1-... | 30 | TN-165102-10-9 | 78 | TSK-064064-25-9 | 88 | WP-044033-10-9 | 66 | WW-044033-10-9 | 80 | ZH-SCE-1K-¾-2.0-<color> | 16 |
| TMS-CCUV-SLEEVE-10-... | 30 | TN-171171-10-9 | 78 | TSK-076191-10-9 | 88 | WP-064064-25-9 | 66 | WW-080080-10-9 | 80 | ZH-SCE-1K-¾-2.0-<color> | 16 |
| TMS-CCUV-SLEEVE-15 | 30 | TN-178095-10-9 | 78 | TSK-080080-10-9 | 88 | WP-080080-10-9 | 66 | WW-089047-10-9 | 80 | ZH-SCE-1K-¾-2.0-<color> | 16 |
| TMS-CCUV-SLEEVE-16 | 30 | TN-191064-10-9 | 78 | TSK-095080-25-9 | 88 | WP-089047-10-9 | 66 | WW-095080-25-9 | 80 | ZH-SCE-1K-¾-2.0-<color> | 16 |
| TMS-CCUV-SLEEVE-17 | 30 | TN-191114-15-9 | 78 | TSK-095095-10-9 | 88 | WP-095080-25-9 | 66 | WW-095095-10-9 | 80 | ZH-SCE-1K-¾-2.0-<color> | 16 |
| TMS-CCUV-SLEEVE-18 | 30 | TN-191762-5-9 | 78 | TSK-127032-10-9 | 88 | WP-095095-10-9 | 66 | WW-101101-1.3-9 | 80 | | |
| TMS-CCUV-SLEEVE-19 | 30 | TN-203127-10-9 | 78 | TSK-127111-10-9 | 88 | WP-101101-1.3-9 | 66 | WW-101165-0.85-9 | 80 | | |
| TMS-CCUV-SLEEVE-2-... | 30 | TN-208086-5-9 | 78 | TSK-127127-10-9 | 88 | WP-101165-0.85-9 | 66 | WW-101508-2.5-9 | 80 | | |
| TMS-CCUV-SLEEVE-20 | 30 | TN-222159-15-9 | 78 | TSK-165051-25-9 | 88 | WP-101508-2.5-9 | 66 | WW-101635-2.5-9 | 80 | | |
| TMS-CCUV-SLEEVE-21 | 30 | TN-229064-10-9 | 78 | TSK-171171-10-9 | 88 | WP-101635-2.5-9 | 66 | WW-101762-1.8-9 | 80 | | |
| TMS-CCUV-SLEEVE-22 | 30 | TN-250381-10-9 | 78 | TSK-178095-10-9 | 88 | WP-101762-1.8-9 | 66 | WW-114040-25-9 | 80 | | |

Данный компонент на территории Российской Федерации

Вы можете приобрести в компании MosChip.

Для оперативного оформления запроса Вам необходимо перейти по данной ссылке:

<http://moschip.ru/get-element>

Вы можете разместить у нас заказ для любого Вашего проекта, будь то серийное производство или разработка единичного прибора.

В нашем ассортименте представлены ведущие мировые производители активных и пассивных электронных компонентов.

Нашей специализацией является поставка электронной компонентной базы двойного назначения, продукции таких производителей как XILINX, Intel (ex.ALTERA), Vicor, Microchip, Texas Instruments, Analog Devices, Mini-Circuits, Amphenol, Glenair.

Сотрудничество с глобальными дистрибьюторами электронных компонентов, предоставляет возможность заказывать и получать с международных складов практически любой перечень компонентов в оптимальные для Вас сроки.

На всех этапах разработки и производства наши партнеры могут получить квалифицированную поддержку опытных инженеров.

Система менеджмента качества компании отвечает требованиям в соответствии с ГОСТ Р ИСО 9001, ГОСТ РВ 0015-002 и ЭС РД 009

Офис по работе с юридическими лицами:

105318, г.Москва, ул.Щербаковская д.3, офис 1107, 1118, ДЦ «Щербаковский»

Телефон: +7 495 668-12-70 (многоканальный)

Факс: +7 495 668-12-70 (доб.304)

E-mail: info@moschip.ru

Skype отдела продаж:

moschip.ru

moschip.ru_4

moschip.ru_6

moschip.ru_9