

Filter for Backpack Mounting to KP01



KP01 Base Module
(not enclosed)

See below:
[Approvals and Compliances](#)

Description

- Component :
Snap-in version from rear-side
- 1 Function :
Line filter in standard and medical version
- For PCB mounting
- Only in combination with base-module type KP01

Characteristics

- Line filter for "backpack" mounting for modules type KP01 (snaps onto rear of KP01)
- Electrical connection done on the PCB
- Suitable for use in medical equipment according to IEC/UL 60601-1
For applications according IEC/UL 62368-1 we recommend variants with bleed resistor

Weblinks

[pdf data sheet](#), [html datasheet](#), [General Product Information](#), [Approvals](#), [Distributor-Stock-Check](#), [Accessories](#), [Detailed request for product](#)

Technical Data

| | |
|---------------------------------|---|
| Ratings IEC | 1 - 10A @ Ta 40 °C / 250VAC; 50Hz |
| Ratings UL/CSA | 1 - 10A @ Ta 40 °C / 250VAC; 60Hz |
| Leakage Current | standard < 0.5mA (250V / 60Hz) medical < 5 µA (250 V / 60 Hz) |
| Dielectric Strength | > 1.7 kVDC between L-N > 2.7 kVDC between L/N-PE Test voltage (2 sec) |
| Allowable Operation Temperature | -25 °C to 70 °C |
| Climatic Category | 25/085/21 acc. to IEC 60068-1 |
| IP-Protection | from front side IP40 acc. to IEC 60529 |
| Protection Class | Suitable for appliances with protection class I acc. to IEC 61140 |
| Terminal | For PCB mounting |
| Material: Housing | Thermoplastic, black, UL 94V-0 |

| | |
|-------------|--|
| Line Filter | Standard and Medical Version, IEC 60939, UL 1283, CSA C22.2 no. 8 Technical Details |
| MTBF | > 2'600'000h acc. to MIL-HB-217 F |

Approvals and Compliances

Detailed information on product approvals, code requirements, usage instructions and detailed test conditions can be looked up in [Details about Approvals](#)

SCHURTER products are designed for use in industrial environments. They have approvals from independent testing bodies according to national and international standards. Products with specific characteristics and requirements such as required in the automotive sector according to IATF 16949, medical technology according to ISO 13485 or in the aerospace industry can be offered exclusively with customer-specific, individual agreements by SCHURTER.

Approvals







The approval mark is used by the testing authorities to certify compliance with the safety requirements placed on electronic products.

Approval Reference Type: KPF

| Approval Logo | Certificates | Certification Body | Description |
|---------------|-------------------------------|--------------------|--------------------------------|
| | VDE Approvals | VDE | VDE Certificate Number: 104869 |
| | UL Approvals | UL | UL File Number: E72928 |



Product standards

Product standards that are referenced

| Organization | Design | Standard | Description |
|--|-----------------------|------------------|---|
|  | Designed according to | IEC 60320-1 | Appliance couplers for household and similar general purposes |
|  | Designed according to | IEC 60939 | Passive filters for suppressing electromagnetic interference |
|  | Designed according to | IEC 61058-1 | Switches for appliances. Part 1. General requirements |
|  | Designed according to | UL 498 | Standard for Attachment Plugs and Receptacles |
|  | Designed according to | UL 1283 | Electromagnetic interference filters |
|  | Designed according to | CSA C22.2 no. 42 | General Use Receptacles, Attachment Plugs, and Similar Wiring Devices |
|  | Designed according to | CSA C22.2 no. 8 | Electromagnetic interference (EMI) filters |





Application standards

Application standards where the product can be used

| Organization | Design | Standard | Description |
|--|--------------------------------|----------------|--|
|  | Designed for applications acc. | IEC/UL 62368-1 | IEC 62368-1 includes the basic requirements for safety of audio, video, information technology and office equipment. |
|  | Designed for applications acc. | IEC 60601-1 | Medical electrical equipment - Part 1: General requirements for basic safety and essential performance |

Compliances

The product complies with following Guide Lines

| Identification | Details | Initiator | Description |
|--|--|-------------|---|
|  | CE declaration of conformity | SCHURTER AG | The CE marking declares that the product complies with the applicable requirements laid down in the harmonisation of Community legislation on its affixing in accordance with EU Regulation 765/2008. |
|  | RoHS | SCHURTER AG | Directive RoHS 2011/65/EU, Amendment (EU) 2015/863 |
|  | China RoHS | SCHURTER AG | The law SJ / T 11363-2006 (China RoHS) has been in force since 1 March 2007. It is similar to the EU directive RoHS. |
|  | REACH | SCHURTER AG | On 1 June 2007, Regulation (EC) No 1907/2006 on the Registration, Evaluation, Authorization and Restriction of Chemicals 1 (abbreviated as "REACH") entered into force. |
|  | Medical Technology | SCHURTER AG | Suitable for use in medical equipment according to IEC/UL 60601-1 |

Dimension [mm]

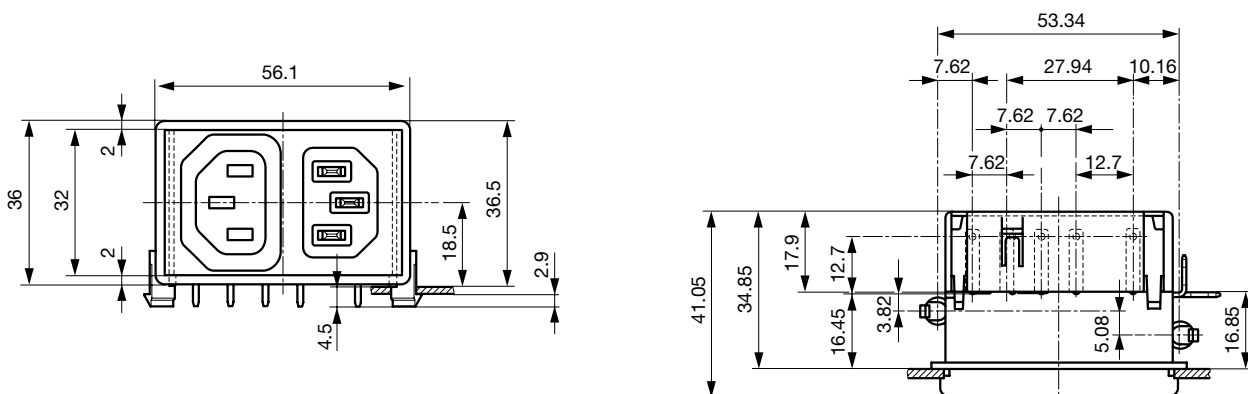

Drilling diagram
 Layout to diagram A

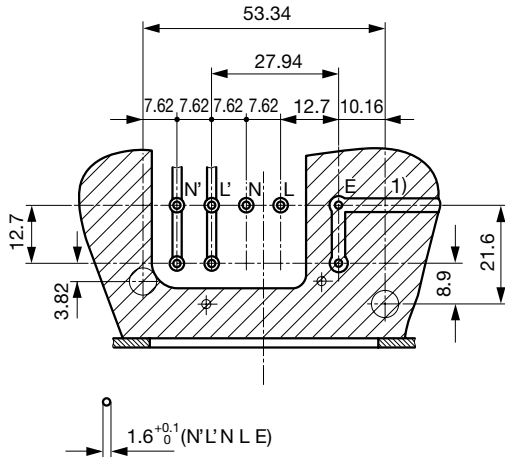

1) Minimum ground plane

Drilling diagram
 Layout to diagram B

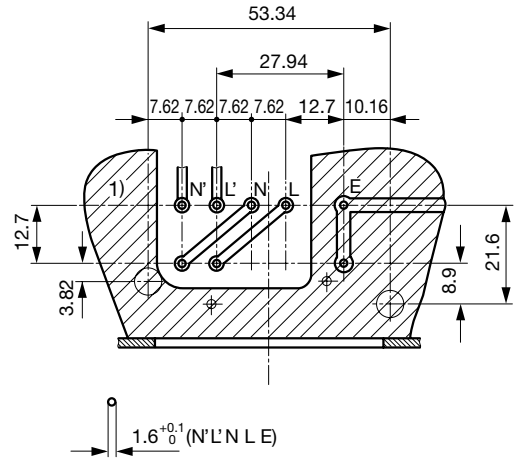

1) Optimal ground plane

Technical Data of Filter-Components

| Rated Current [A] | Filter-Type | Inductances L [mH] | Capacitance CX [nF] | Capacitance CY [nF] | R [MΩ] |
|-------------------|----------------------|--------------------|---------------------|---------------------|--------|
| 1 | Standard version | 2 x 10 | 100 | 2.2 | - |
| 2 | Standard version | 2 x 4 | 100 | 2.2 | - |
| 4 | Standard version | 2 x 1.6 | 100 | 2.2 | - |
| 6 | Standard version | 2 x 1 | 100 | 2.2 | - |
| 8 | Standard version | 2 x 0.6 | 100 | 2.2 | - |
| 10 | Standard version | 2 x 0.4 | 100 | 2.2 | - |
| 1 | Medical Version (M5) | 2 x 10 | 100 | - | 1 |
| 2 | Medical Version (M5) | 2 x 4 | 100 | - | 1 |
| 4 | Medical Version (M5) | 2 x 1.6 | 100 | - | 1 |
| 6 | Medical Version (M5) | 2 x 1 | 100 | - | 1 |
| 8 | Medical Version (M5) | 2 x 0.6 | 100 | - | 1 |
| 10 | Medical Version (M5) | 2 x 0.4 | 100 | - | 1 |

Diagrams

Standard line filter

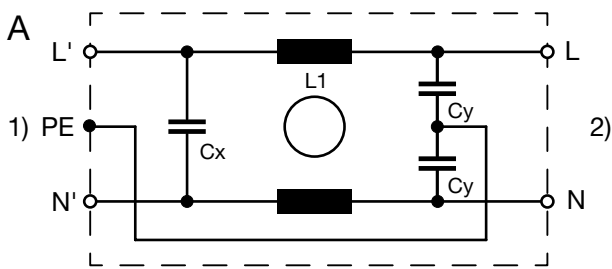

1) Line
 2) Load

EMI filtering of equipment emissions

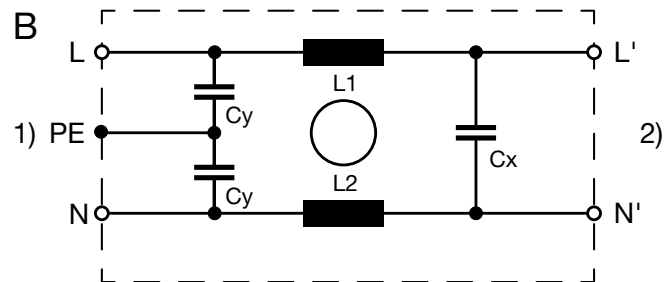

1) Line
 2) Load

Attenuation Loss

--- 50Ω differential mode ___ 50Ω common mode

Standard version

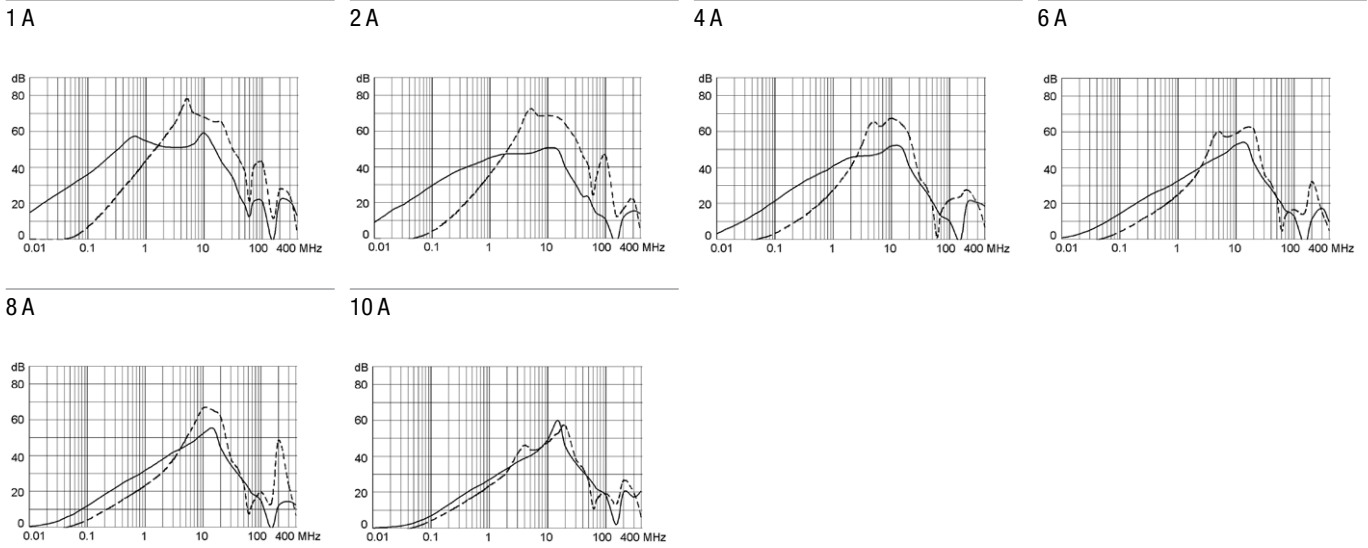

Medical version (M5)

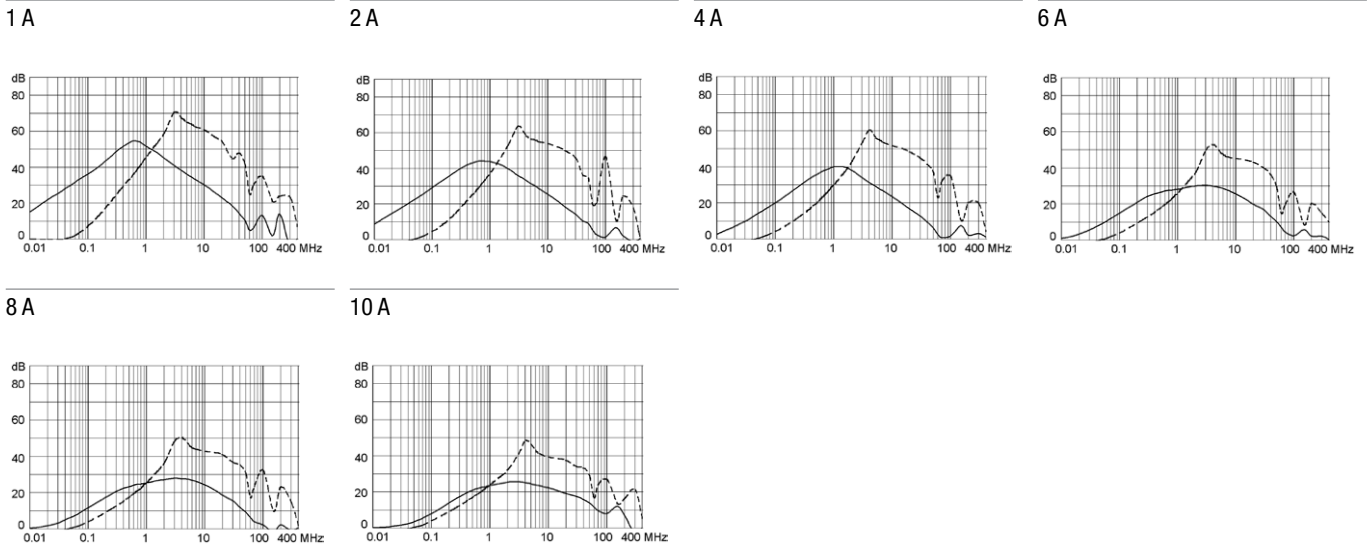

All Variants

| Rated Current [A] | Filter-Type | Order Number |
|-------------------|----------------------|--------------|
| 1 | Standard version | KPF1.1 |
| 2 | Standard version | KPF2.1 |
| 4 | Standard version | KPF4.1 |
| 6 | Standard version | KPF6.1 |
| 8 | Standard version | KPF8.1 |
| 10 | Standard version | KPF0.1 |
| 1 | Medical Version (M5) | KPF1.3 |
| 2 | Medical Version (M5) | KPF2.3 |
| 4 | Medical Version (M5) | KPF4.3 |
| 6 | Medical Version (M5) | KPF6.3 |
| 8 | Medical Version (M5) | KPF8.3 |
| 10 | Medical Version (M5) | KPF0.3 |

Availability for all products can be searched real-time: <https://www.schurter.com/en/Stock-Check/Stock-Check-SCHURTER>

Packaging unit 50 Pcs

Данный компонент на территории Российской Федерации

Вы можете приобрести в компании MosChip.

Для оперативного оформления запроса Вам необходимо перейти по данной ссылке:

<http://moschip.ru/get-element>

Вы можете разместить у нас заказ для любого Вашего проекта, будь то серийное производство или разработка единичного прибора.

В нашем ассортименте представлены ведущие мировые производители активных и пассивных электронных компонентов.

Нашей специализацией является поставка электронной компонентной базы двойного назначения, продукции таких производителей как XILINX, Intel (ex.ALTERA), Vicor, Microchip, Texas Instruments, Analog Devices, Mini-Circuits, Amphenol, Glenair.

Сотрудничество с глобальными дистрибьюторами электронных компонентов, предоставляет возможность заказывать и получать с международных складов практически любой перечень компонентов в оптимальные для Вас сроки.

На всех этапах разработки и производства наши партнеры могут получить квалифицированную поддержку опытных инженеров.

Система менеджмента качества компании отвечает требованиям в соответствии с ГОСТ Р ИСО 9001, ГОСТ РВ 0015-002 и ЭС РД 009

Офис по работе с юридическими лицами:

105318, г.Москва, ул.Щербаковская д.3, офис 1107, 1118, ДЦ «Щербаковский»

Телефон: +7 495 668-12-70 (многоканальный)

Факс: +7 495 668-12-70 (доб.304)

E-mail: info@moschip.ru

Skype отдела продаж:

moschip.ru

moschip.ru_4

moschip.ru_6

moschip.ru_9