

# Surge Protection Made Simple™ for IEC Applications

## IEC Class I Combined Lightning, Current and Surge Arrester for 230/400 Volt, 3-Pole TNC Systems



### Description

The Cooper Bussmann® IEC Class I 230 Volt, three-pole, modular combined lightning, current and surge arresters feature local, *easyID™* visual indication and optional remote contact signaling. The unique module locking system fixes the protection module to the base part. Modules can be easily replaced without tools by simply depressing the release buttons. Integrated mechanical coding between the base and protection module ensures against installing an incorrect replacement module.

230 Volt models are offered with a MCOV rating of 255 volts.

### TNC System Arrester

The features of these three-pole devices are for use in TN-C 230/400 Volt systems ("3-0" circuit) against surges.

### Remote Signaling Contact

The three-pole terminal remote signaling contact versions have a floating changeover contact for use as a break or make contact, according to circuit concept.



### Dimensions - mm

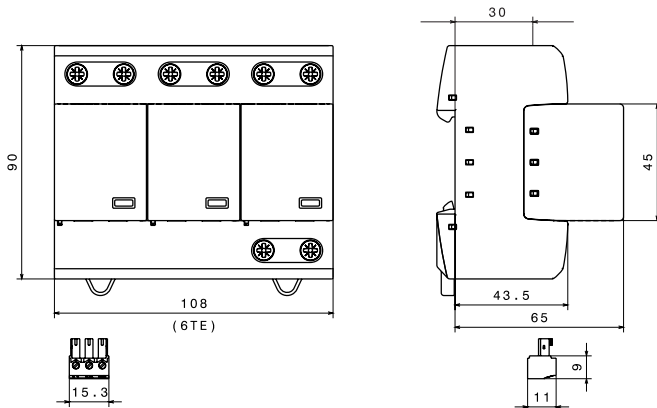

Shown with optional remote contact signaling

### Circuit Diagrams

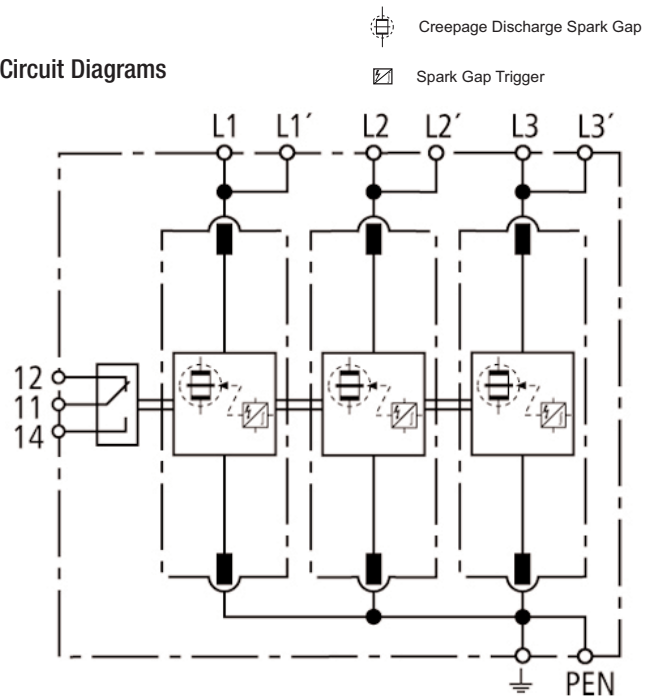

**BPS3255TNC(R)**

Shown with optional remote contact signaling

Ordering Information	
System Voltage/Poles	230/400V/3
Max. Continuous operating AC voltage (MCOV) [U <sub>C</sub> ]	255V
Catalog Numbers:	Without Remote Signaling BSPS3255TNC
	With Remote Signaling BSPS3255TNCR
Replacement Module	Spark Gap Technology BPS255IEC
Specifications	
SPD according to EN 61643-11/... IEC 61643-1	Type 1/Class I
Energy-coordinated protection effect with regard to the terminal equipment	Type 1 + Type 2
Energy-coordinated protection effect with regard to the terminal equipment (≤ 5m)	Type 1 + Type 2 + Type 3
Nominal AC voltage [U <sub>N</sub> ]	230/400V
Lightning impulse current (10/350 μs) [L1+L2+L3-PEN] [I <sub>total</sub> ]	75kA
Specific energy [L1+L2+L3-PEN] [W/R]	1.40 MJ/ohms
Lightning impulse current (10/350 μs) [L-PEN] [I <sub>imp</sub> ]	25kA
Specific energy [L-PEN] [W/R]	156.25kJ/ohms
Nominal discharge current (8/20 μs) [I <sub>n</sub> ]	25/75kA
Voltage protection level [U <sub>p</sub> ]	≤ 1.5kV
Follow current extinguishing capability AC [I <sub>fi</sub> ]	50kA rms
Follow current limitation/Selectivity	no tripping of a 20A gL/gG fuse up to 50kA rms (prosp.)
Response time [t <sub>A</sub> ]	≤ 100 ns
Max. Backup fuse (L) up to I <sub>K</sub> = 50kA rms	315A gL/gG
Max. Backup fuse (L) for I <sub>K</sub> > 50kA rms	200A gL/gG
Max. Backup fuse (L-L)	125A gL/gG
Temporary overvoltage (TOV) [U <sub>T</sub> ]	440V/5 sec.
TOV characteristics	withstand
Operating temperature range [parallel]/[continuity] [T <sub>U</sub> ]	-40°C to +80°C/-40°C to +60°C
Operating state/fault indication	green (good)/red (replace)
Number of ports	1
Cross-sectional area (L1, L1', L2, L2', L3, L3', PEN, $\frac{\perp}{\perp}$ ) [min.]	10mm <sup>2</sup> solid/flexible
Cross-sectional area (L1, L2, L3, PEN) [max.]	50mm <sup>2</sup> /1AWG stranded-35mm <sup>2</sup> /2AWG flexible
Cross-sectional area (L1', L2', L3', $\frac{\perp}{\perp}$ ) [max.]	35mm <sup>2</sup> /2AWG stranded-25mm <sup>2</sup> /4AWG flexible
Mounting	35mm DIN rail per to EN 60715
Enclosure material	Thermoplastic, UL 94V0
Location category	Indoor
Degree of protection	IP20
Capacity	6 mods., DIN 43880
Standards Information	KEMA
Product Warranty	Five Years*
Remote Contact Signaling	
Remote Contact Signaling Type	Changeover Contact
AC Switching Capacity (Volts/Amps)	250V/0.1A
DC Switching Capacity (Volts/Amps)	250V/0.1A; 125V/0.2A; 75V/0.5A
Conductor Ratings and Cross-Sectional Area for Remote Contact Signal Terminals	60/75°C Max. 1.5mm <sup>2</sup> /1AWG Solid/Flexible
Ordering Information	Order from Catalog Numbers Above

\* See Cooper Bussmann SPD Limited Warranty Statement (3A1502) for details at [www.cooperbussmann.com/surge](http://www.cooperbussmann.com/surge).

Recommended Cooper Bussmann NH DIN Size Back Up Fuses			
Size	NH Fuse Part Number	Size	NH Fuse Part Number
00	125NHG00B (max L-L)	02	125NHG02B (max L-L)
0	125NHG0B (max L-L)	02	200NHG02B (max L I <sub>k</sub> >50kA)
01	125NHG01B (max L-L)	2	315NHG2B (max L ≤50kA)
1	200NHG1B (max L I <sub>k</sub> >50kA)	03	315NHG03B (max L ≤50kA)

The only controlled copy of this Data Sheet is the electronic read-only version located on the Cooper Bussmann Network Drive. All other copies of this document are by definition uncontrolled. This bulletin is intended to clearly present comprehensive product data and provide technical information that will help the end user with design applications. Cooper Bussmann reserves the right, without notice, to change design or construction of any products and to discontinue or limit distribution of any products. Cooper Bussmann also reserves the right to change or update, without notice, any technical information contained in this bulletin. Once a product has been selected, it should be tested by the user in all possible applications.

## Данный компонент на территории Российской Федерации

### Вы можете приобрести в компании MosChip.

Для оперативного оформления запроса Вам необходимо перейти по данной ссылке:

<http://moschip.ru/get-element>

Вы можете разместить у нас заказ для любого Вашего проекта, будь то серийное производство или разработка единичного прибора.

В нашем ассортименте представлены ведущие мировые производители активных и пассивных электронных компонентов.

Нашей специализацией является поставка электронной компонентной базы двойного назначения, продукции таких производителей как XILINX, Intel (ex.ALTERA), Vicor, Microchip, Texas Instruments, Analog Devices, Mini-Circuits, Amphenol, Glenair.

Сотрудничество с глобальными дистрибьюторами электронных компонентов, предоставляет возможность заказывать и получать с международных складов практически любой перечень компонентов в оптимальные для Вас сроки.

На всех этапах разработки и производства наши партнеры могут получить квалифицированную поддержку опытных инженеров.

Система менеджмента качества компании отвечает требованиям в соответствии с ГОСТ Р ИСО 9001, ГОСТ РВ 0015-002 и ЭС РД 009

### Офис по работе с юридическими лицами:

105318, г.Москва, ул.Щербаковская д.3, офис 1107, 1118, ДЦ «Щербаковский»

Телефон: +7 495 668-12-70 (многоканальный)

Факс: +7 495 668-12-70 (доб.304)

E-mail: [info@moschip.ru](mailto:info@moschip.ru)

Skype отдела продаж:

moschip.ru

moschip.ru\_4

moschip.ru\_6

moschip.ru\_9