

2 × 6A Digital Dual Output MicroDlynx™: Non-Isolated DC-DC Power Modules

4.5Vdc –14.4Vdc input; 0.51Vdc to 5.5Vdc output; 2 × 6A Output Current



RoHS Compliant

Features

- Compliant to RoHS II EU "Directive 2011/65/EU"
- Compliant to IPC-9592 (September 2008), Category 2, Class II
- Compatible in a Pb-free or SnPb reflow environment (Z versions)
- Compliant to REACH Directive (EC) No 1907/2006
- Wide Input voltage range (4.5Vdc-14.4Vdc) on both inputs
- Each Output voltage programmable from 0.6Vdc to 5.5Vdc via external resistor. Digitally adjustable down to 0.51Vdc
- Digital interface through the PMBus™ # protocol
- Tunable Loop™ to optimize dynamic output voltage response
- Power Good signal for each output
- Fixed switching frequency with capability of external synchronization
- 180° Out-of-phase inputs to reduce input ripple
- Output overcurrent protection (non-latching)
- Output Overvoltage protection
- Over temperature protection
- Remote On/Off
- Ability to sink and source current
- Start up into Pre-biased output
- Cost efficient open frame design
- Small size: 20.32 mm x 11.43 mm x 8.5 mm (0.8 in x 0.45 in x 0.335 in)
- Wide operating temperature range [-40°C to 105°C(Ruggedized: -D), 85°C(Regular)]
- Ruggedized (-D) version able to withstand high levels of shock and vibration
- UL* 60950-1 2nd Ed. Recognized, CSA† C22.2 No. 60950-1-07 Certified, and VDE‡ (EN60950-1 2nd Ed.) Licensed
- ISO** 9001 and ISO 14001 certified manufacturing facilities

Applications

- Distributed power architectures
- Intermediate bus voltage applications
- Telecommunications equipment
- Servers and storage applications
- Networking equipment
- Industrial equipment

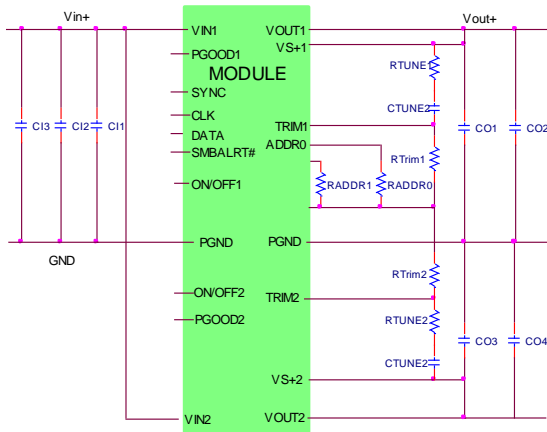

Description

The 2 × 6A Digital Dual MicroDlynx™ power modules are non-isolated dc-dc converters that can deliver up to 2 × 6A of output current. These modules operate over a wide range of input voltage ($V_{IN} = 4.5\text{Vdc}-14.4\text{Vdc}$) and provide precisely regulated output voltages from 0.51Vdc to 5.5Vdc, programmable via an external resistor and PMBus control. Features include a digital interface using the PMBus protocol, remote On/Off, adjustable output voltage, over current and over temperature protection. The PMBus interface supports a range of commands to both control and monitor the module. The module also includes the Tunable Loop™ feature that allows the user to optimize the dynamic response of the converter to match the load with reduced amount of output capacitance leading to savings on cost and PWB area.

* UL is a registered trademark of Underwriters Laboratories, Inc.

† CSA is a registered trademark of Canadian Standards Association.

‡ VDE is a trademark of Verband Deutscher Elektrotechniker e.V.

** ISO is a registered trademark of the International Organization of Standards

The PMBus name and logo are registered trademarks of the System Management Interface Forum (SMIF)

2 × 6A Digital Dual MicroDlynx™: Non-Isolated DC-DC Power Modules

4.5Vdc –14.4Vdc input; 0.51Vdc to 5.5Vdc output; 2 × 6A Output Current

Absolute Maximum Ratings

Stresses in excess of the absolute maximum ratings can cause permanent damage to the device. These are absolute stress ratings only, functional operation of the device is not implied at these or any other conditions in excess of those given in the operations sections of the data sheet. Exposure to absolute maximum ratings for extended periods can adversely affect the device reliability.

Parameter	Device	Symbol	Min	Max	Unit
Input Voltage Continuous	All	V_{IN1} and V_{IN2}	-0.3	15	V
VS+1, VS+2, SMBALERT#	All		-0.3	7	V
CLK, DATA, SYNC,	All		-0.3	3.6	V
Operating Ambient Temperature (see Thermal Considerations section)	All -D Version	T_A T_A	-40 -40	85 105	°C °C
Storage Temperature	All	T_{stg}	-55	125	°C

Electrical Specifications

Unless otherwise indicated, specifications apply over all operating input voltage, resistive load, and temperature conditions.

Parameter	Device	Symbol	Min	Typ	Max	Unit
Operating Input Voltage	All	V_{IN1} and V_{IN2}	4.5	—	14.4	Vdc
Maximum Input Current ($V_{IN}=3V$ to 14.4V, $I_O=I_{O,max}$)	All	$I_{IN1,max}$ & $I_{IN2,max}$			12	Adc
Input No Load Current ($V_{IN} = 12Vdc$, $I_O = 0$, module enabled)	$V_{O,set} = 0.6 Vdc$	$I_{IN1,No load}$ & $I_{IN2,No load}$		40		mA
	$V_{O,set} = 5.5Vdc$	$I_{IN1,No load}$ & $I_{IN2,No load}$		140		mA
Input Stand-by Current ($V_{IN} = 12Vdc$, module disabled)	All	$I_{IN1,stand-by}$ & $I_{IN2,stand-by}$		14		mA
Inrush Transient	All	I_1^2t & I_2^2t			1	A ² s
Input Reflected Ripple Current, peak-to-peak (5Hz to 20MHz, 1 μ H source impedance; $V_{IN} = 4.5$ to 14V, $I_O = I_{O,max}$; See Test Configurations)	All	Both Inputs		25		mAp-p
Input Ripple Rejection (120Hz)	All	Both Inputs		-68		dB

2 × 6A Digital Dual MicroDlynx™: Non-Isolated DC-DC Power Modules

4.5Vdc –14.4Vdc input; 0.51Vdc to 5.5Vdc output; 2 × 6A Output Current

Electrical Specifications (continued)

Parameter	Device	Symbol	Min	Typ	Max	Unit
Output Voltage Set-point (with 0.1% tolerance for external resistor used to set output voltage)	All	VO1, set & VO2, set	-1.0		+1.0	% VO _{set}
Output Voltage (Over all operating input voltage, resistive load, and temperature conditions until end of life)	All	Vo1, set & VO2, set	-3.0	—	+3.0	% VO _{set}
Adjustment Range (selected by an external resistor) (Some output voltages may not be possible depending on the input voltage – see Feature Descriptions Section) *0.51V possible through PMBus command	All	VO1 & VO2	0.6*		5.5	Vdc
PMBus Adjustable Output Voltage Range	All	VO _{1,adj} , VO _{2,adj}	-15	0	+10	%VO _{set}
PMBus Output Voltage Adjustment Step Size	All	Both outputs	0.4			%VO _{set}
Remote Sense Range	All	Both outputs			0.5	Vdc
Output Regulation (for VO ≥ 2.5Vdc)		Both Outputs				
Line (VIN=VIN, min to VIN, max)	All	Both Outputs		—	+0.4	% VO _{set}
Load (IO=IO, min to IO, max)	All	Both Outputs		—	10	mV
Output Regulation (for VO < 2.5Vdc)		Both Outputs				
Line (VIN=VIN, min to VIN, max)	All	Both Outputs		—	5	mV
Load (IO=IO, min to IO, max)	All	Both Outputs		—	10	mV
Temperature (T _{ref} =TA, min to TA, max)	All	Both Outputs		—	0.4	% VO _{set}
Input Noise on nominal output at 25°C (VIN=VIN, nom and IO=IO, min to IO, max Cin = 2x1x4.7nF (for equiv.) + 2x2x22uF ceramic + 2x470uF electrolytic Peak-to-Peak (Full Bandwidth)	All	Both Inputs	—	360		mVpk-pk
Output Ripple and Noise on nominal output at 25°C (VIN=VIN, nom and IO=IO, min to IO, max Co = 2x4.7nF + 2x47uF per output)						
Peak-to-Peak (5Hz to 20MHz bandwidth)	All		—	50		mV _{pk-pk}
RMS (5Hz to 20MHz bandwidth)	All			30		mV _{rms}
Output Ripple and Noise on nominal output at 25°C (VIN=VIN, nom and IO=IO, min to IO, max Co = 2x4.7nF (or equiv.) + 2x47uF per output)						
Peak-to-Peak (Full bandwidth)(Vo≤1.2Vo)		Both Outputs		30		mVpk-pk
Peak-to-Peak (Full bandwidth)(Vo>1.2Vo)		Both Outputs		3%Vo		mVpk-pk
RMS (Full bandwidth)	All	Both Outputs		30		mV _{rms}
External Capacitance ¹						
Without the Tunable Loop™						
ESR ≥ 1 mΩ	All	CO, max	1x47	—	2x47	μF
With the Tunable Loop™						
ESR ≥ 0.15 mΩ	All	CO, max		—	1000	μF
ESR ≥ 10 mΩ	All	CO, max		—	5000	μF
Output Current (in either sink or source mode)	All	IO	0		6 x 2	Adc
Output Current Limit Inception (Hiccup Mode) (current limit does not operate in sink mode)	All	IO, lim		150		% IO, max
Output Short-Circuit Current (VO≤250mV) (Hiccup Mode)	All	IO1, s/c, IO1, s/c		5		Arms

¹ External capacitors may require using the new Tunable Loop™ feature to ensure that the module is stable as well as getting the best transient response. See the Tunable Loop™ section for details.

2 × 6A Digital Dual MicroDlynx™: Non-Isolated DC-DC Power Modules

4.5Vdc – 14.4Vdc input; 0.51Vdc to 5.5Vdc output; 2 × 6A Output Current

Electrical Specifications (continued)

Parameter	Device	Symbol	Min	Typ	Max	Unit
Efficiency $V_{IN} = 12\text{Vdc}$, $T_A = 25^\circ\text{C}$ $I_O = I_{O, \text{max}}$, $V_O = V_{O, \text{set}}$	$V_{O, \text{set}} = 0.6\text{Vdc}$	η_1, η_2		79.3		%
	$V_{O, \text{set}} = 1.2\text{Vdc}$	η_1, η_2		87.3		%
	$V_{O, \text{set}} = 1.8\text{Vdc}$	η_1, η_2		90.3		%
	$V_{O, \text{set}} = 2.5\text{Vdc}$	η_1, η_2		92.1		%
	$V_{O, \text{set}} = 3.3\text{Vdc}$	η_1, η_2		93.3		%
	$V_{O, \text{set}} = 5.0\text{Vdc}$	η_1, η_2		94.8		%
Switching Frequency	All	f_{sw}	—	500	—	kHz
Frequency Synchronization	All					
Synch Frequency ($2 \times f_{\text{switch}}$)				1000		kHz
Synchronization Frequency Range	All		-5%		+5%	
High-Level Input Voltage	All	V_{IH}	2.0			V
Low-Level Input Voltage	All	V_{IL}			0.4	V
Input Current, SYNC	All	I_{SYNC}			100	nA
Minimum Pulse Width, SYNC	All	t_{SYNC}	100			ns
Maximum SYNC rise time	All	$t_{\text{SYNC_SH}}$	100			ns

General Specifications

Parameter	Device	Min	Typ	Max	Unit
Calculated MTBF ($I_O = 0.8I_{O, \text{max}}$, $T_A = 40^\circ\text{C}$) Telecordia Issue 3 Method I Case 3	All		87,926,219		Hours
Weight		—	4.5 (0.16)	—	g (oz.)

Feature Specifications

Unless otherwise indicated, specifications apply over all operating input voltage, resistive load, and temperature conditions. See Feature Descriptions for additional information.

Parameter	Device	Symbol	Min	Typ	Max	Unit
On/Off Signal Interface ($V_{\text{IN}} = V_{\text{IN, min}}$ to $V_{\text{IN, max}}$; open collector or equivalent, Signal referenced to GND)						
Device Code with no suffix – Negative Logic (See Ordering Information) (On/OFF pin is open collector/drain logic input with external pull-up resistor; signal referenced to GND)						
Logic High (Module OFF)						
Input High Current	All	$I_{\text{IH1}}, I_{\text{IH2}}$	—	—	1	mA
Input High Voltage	All	$V_{\text{IH1}}, V_{\text{IH2}}$	2	—	$V_{\text{IN, max}}$	Vdc
Logic Low (Module ON)						
Input low Current	All	$I_{\text{IL1}}, I_{\text{IL2}}$	—	—	20	μA
Input Low Voltage	All	$V_{\text{IL1}}, V_{\text{IL2}}$	-0.2	—	0.6	Vdc
Turn-On Delay and Rise Times						
($V_{\text{IN}} = V_{\text{IN, nom}}$, $I_O = I_{O, \text{max}}$, V_O to within $\pm 1\%$ of steady state) Case 1: On/Off input is enabled and then input power is applied (delay from instant at which $V_{\text{IN}} = V_{\text{IN, min}}$ until $V_O = 10\%$ of $V_{O, \text{set}}$)	All	$T_{\text{delay1}}, T_{\text{delay2}}$	—	2	—	msec

2 × 6A Digital Dual MicroDlynx™: Non-Isolated DC-DC Power Modules

4.5Vdc –14.4Vdc input; 0.51Vdc to 5.5Vdc output; 2 × 6A Output Current

Feature Specifications (cont.)

Parameter	Device	Symbol	Min	Typ	Max	Unit
Case 2: Input power is applied for at least one second and then the On/Off input is enabled (delay from instant at which Von/Off is enabled until $V_o = 10\%$ of $V_{o, set}$)	All	Tdelay1, Tdelay2	—	800	—	μsec
Output voltage Rise time (time for V_o to rise from 10% of V_o , set to 90% of V_o , set)	All	Trise1, Trise2	—	5	—	msec
Output voltage overshoot ($T_A = 25^\circ\text{C}$ $V_{IN} = V_{IN, min}$ to $V_{IN, max}$, $I_O = I_{O, min}$ to $I_{O, max}$) With or without maximum external capacitance		Both Outputs			3.0	% $V_{o, set}$
Over Temperature Protection (See Thermal Considerations section)	All	T_{ref}		120		$^\circ\text{C}$
PMBus Over Temperature Warning Threshold*	All	T_{WARN}		115		$^\circ\text{C}$
Input Undervoltage Lockout						
Turn-on Threshold	All	Both Inputs			4.5	Vdc
Turn-off Threshold	All	Both Inputs			4.25	Vdc
Hysteresis	All	Both Inputs	0.15	0.2		Vdc
PMBus Adjustable Input Under Voltage Lockout Thresholds	All	Both Inputs	4		14	Vdc
Resolution of Adjustable Input Under Voltage Threshold	All	Both Inputs			250	mV
PGOOD (Power Good)						
Signal Interface Open Drain, $V_{supply} \leq 5\text{VDC}$						
Overvoltage threshold for PGOOD ON	All	Both Outputs		108.33		% $V_{o, set}$
Overvoltage threshold for PGOOD OFF	All	Both Outputs		112.5		% $V_{o, set}$
Undervoltage threshold for PGOOD ON	All	Both Outputs		91.67		% $V_{o, set}$
Undervoltage threshold for PGOOD OFF	All	Both Outputs		87.5		% $V_{o, set}$
Pull-down resistance of PGOOD pin	All	Both Outputs		40	70	Ω
Sink current capability into PGOOD pin	All	Both Outputs			5	mA

* Over temperature Warning – Warning may not activate before alarm and unit may shutdown before warning

2 × 6A Digital Dual MicroDlynx™: Non-Isolated DC-DC Power Modules

4.5Vdc –14.4Vdc input; 0.51Vdc to 5.5Vdc output; 2 × 6A Output Current

Digital Interface Specifications

Unless otherwise indicated, specifications apply over all operating input voltage, resistive load, and temperature conditions. See Feature Descriptions for additional information.

Parameter	Conditions	Symbol	Min	Typ	Max	Unit
PMBus Signal Interface Characteristics						
Input High Voltage (CLK, DATA)		V_{IH}	2.1			V
Input Low Voltage (CLK, DATA)		V_{IL}			0.8	V
Input high level current (CLK, DATA)		I_{IH}	-10		10	μ A
Input low level current (CLK, DATA)		I_{IL}	-10		10	mA
Output Low Voltage (CLK, DATA, SMBALERT#)	$I_{OUT}=2\text{mA}$	V_{OL}			0.4	V
Output high level open drain leakage current (DATA, SMBALERT#)	$V_{OUT}=3.6\text{V}$	I_{OH}	0		10	μ A
Pin capacitance		C_o		0	1	pF
PMBus Operating frequency range	Slave Mode	F_{PMB}	10		400	kHz
Data hold time	Receive Mode Transmit Mode	$t_{HD:DAT}$	0 300			ns
Data setup time		$t_{SU:DAT}$	250			ns
Measurement System Characteristics						
Output current measurement range		I_{RNG}	0		9	A
Output current measurement gain accuracy (at 25°C)		I_{ACC}			± 1	A
V_{OUT} measurement range		$V_{OUT(rng)}$	0.5		5.8	V
V_{OUT} measurement accuracy			-2		2	%

2 × 6A Digital Dual MicroDlynx™: Non-Isolated DC-DC Power Modules

4.5Vdc –14.4Vdc input; 0.51Vdc to 5.5Vdc output; 2 × 6A Output Current

Characteristic Curves

The following figures provide typical characteristics for the 2 × 6A Digital Dual MicroDlynx™ at 0.6V_o and 25°C.

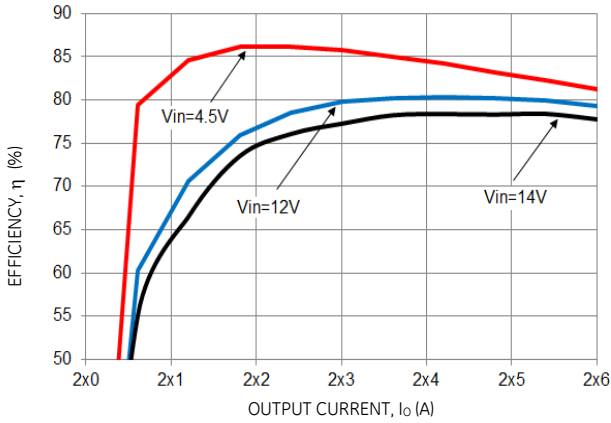

Figure 1. Converter Efficiency versus Output Current.

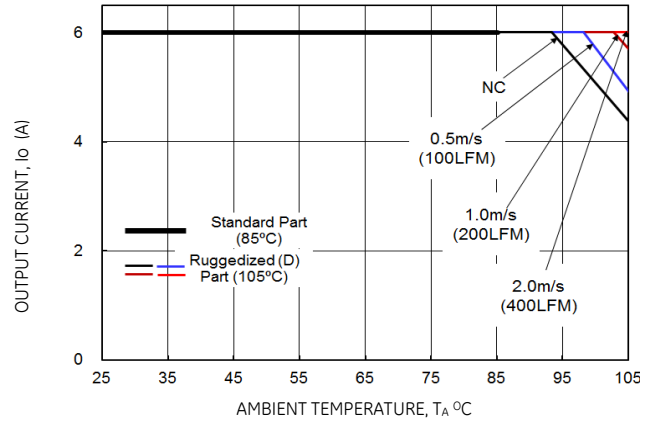

Figure 2. Derating Output Current versus Ambient Temperature and Airflow.

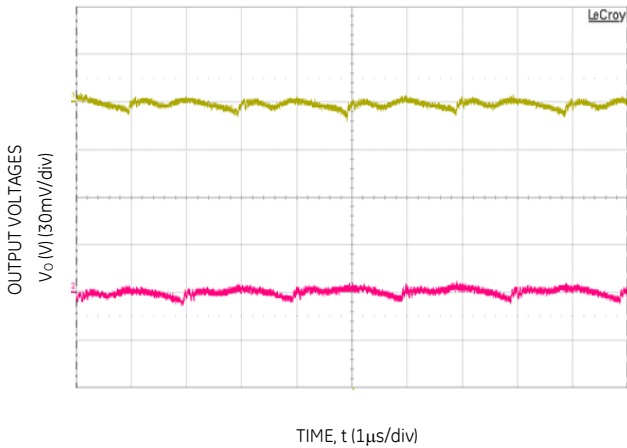

Figure 3. Typical output ripple and noise (C_o= 2×4.7nF+2×47µF ceramic, V_{IN} = 12V, I_o = I_{o1,max}, I_{o2,max}).

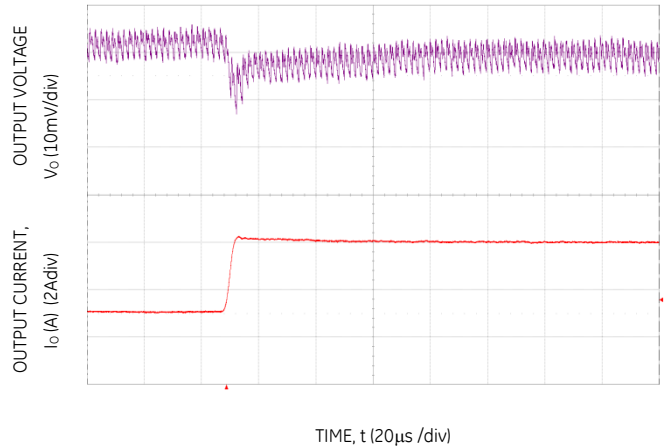

Figure 4. Transient Response to Dynamic Load Change from 50% to 100% on one output at 12V_{in}, C_{out}=3×47µF+3×330µF, C_{Tune}=12nF, R_{Tune}=300Ω

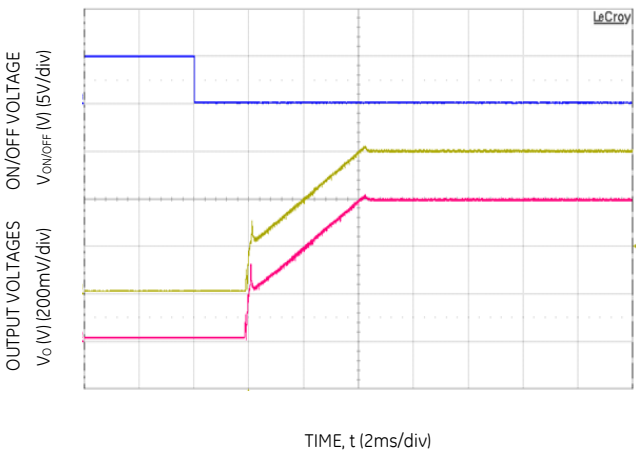

Figure 5. Typical Start-up Using On/Off Voltage (V_{IN}=12V, I_o = I_{o1,max}, I_{o2,max}).

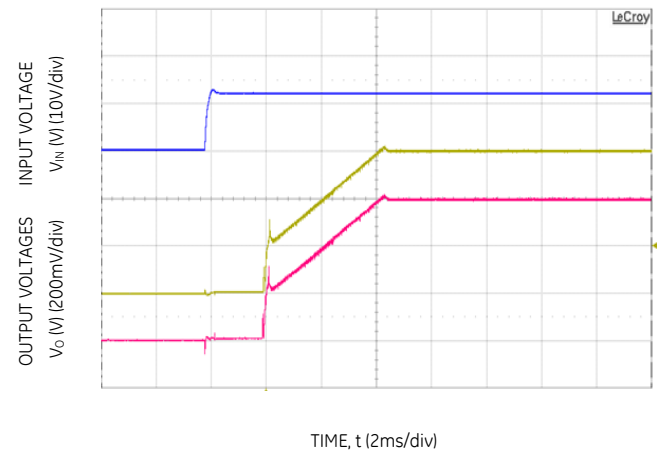

Figure 6. Typical Start-up Using Input Voltage (V_{IN} = 12V, I_o = I_{o1,max}, I_{o2,max}).

2 × 6A Digital Dual MicroDlynx™: Non-Isolated DC-DC Power Modules

4.5Vdc – 14.4Vdc input; 0.51Vdc to 5.5Vdc output; 2 × 6A Output Current

Characteristic Curves

The following figures provide typical characteristics for the 2 × 6A Digital Dual MicroDlynx™ at 1.2Vo and 25°C.

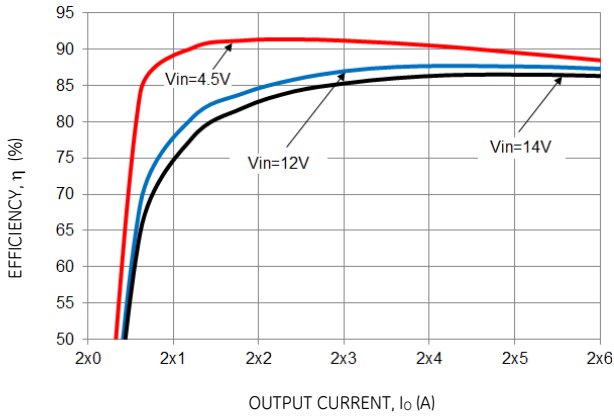

Figure 7. Converter Efficiency versus Output Current.

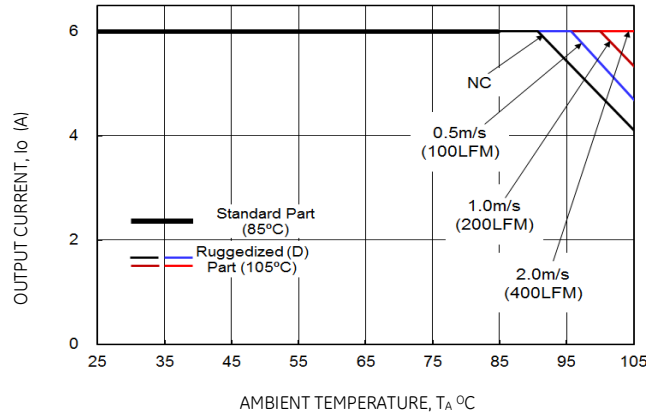

Figure 8. Derating Output Current versus Ambient Temperature and Airflow.

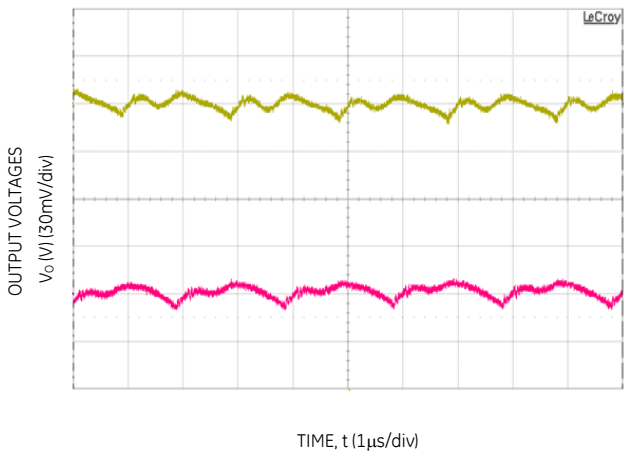

Figure 9. Typical output ripple and noise ($C_o = 2 \times 4.7nF + 2 \times 47\mu F$ ceramic, $V_{IN} = 12V$, $I_o = I_{o1,max}, I_{o2,max}$).

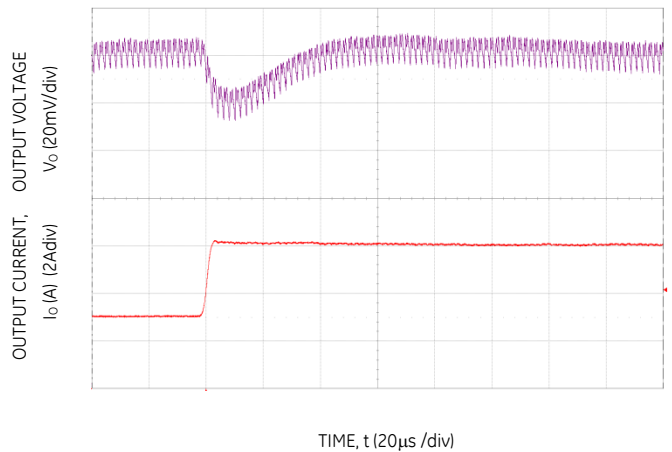

Figure 10. Transient Response to Dynamic Load Change on one output from 50% to 100% at 12Vin, $C_{out} = 3 \times 47\mu F + 2 \times 330\mu F$, $C_{Tune} = 2700pF$ & $R_{Tune} = 300\Omega$

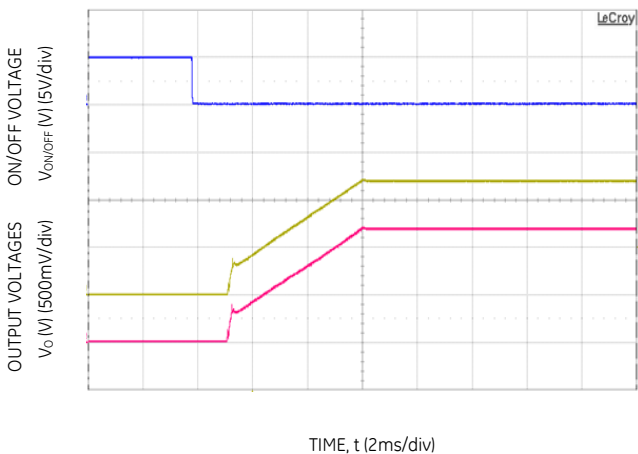

Figure 11. Typical Start-up Using On/Off Voltage ($V_{IN} = 12V$, $I_o = I_{o1,max}, I_{o2,max}$).

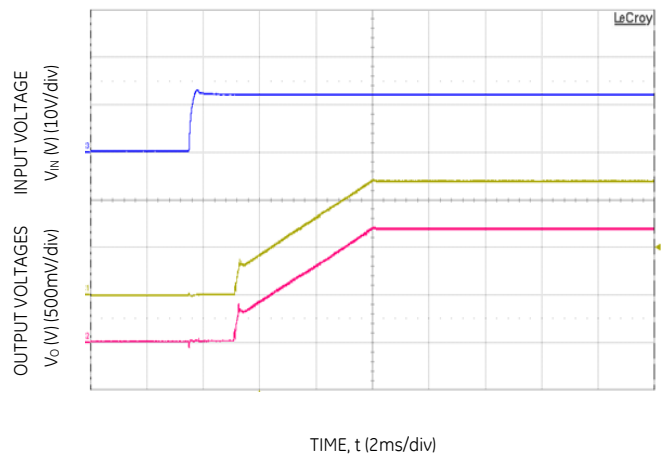

Figure 12. Typical Start-up Using Input Voltage ($V_{IN} = 12V$, $I_o = I_{o1,max}, I_{o2,max}$).

2 × 6A Digital Dual MicroDlynx™: Non-Isolated DC-DC Power Modules

4.5Vdc –14.4Vdc input; 0.51Vdc to 5.5Vdc output; 2 × 6A Output Current

Characteristic Curves

The following figures provide typical characteristics for the 2 × 6A Digital Dual MicroDlynx™ at 1.8Vo and 25°C.

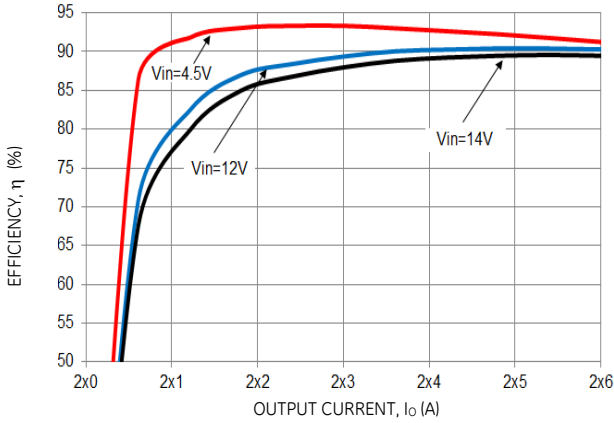

Figure 13. Converter Efficiency versus Output Current.

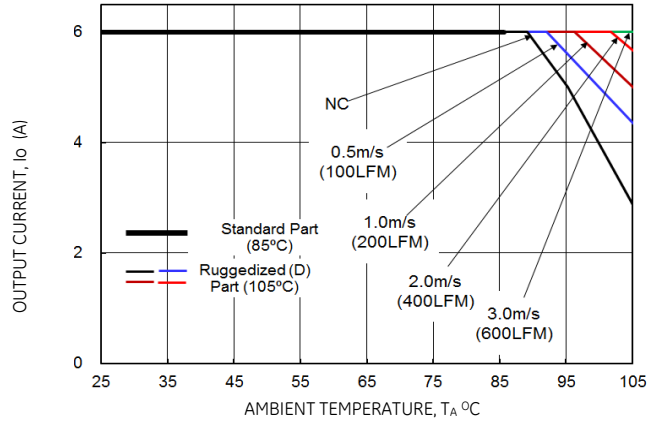

Figure 14. Derating Output Current versus Ambient Temperature and Airflow.

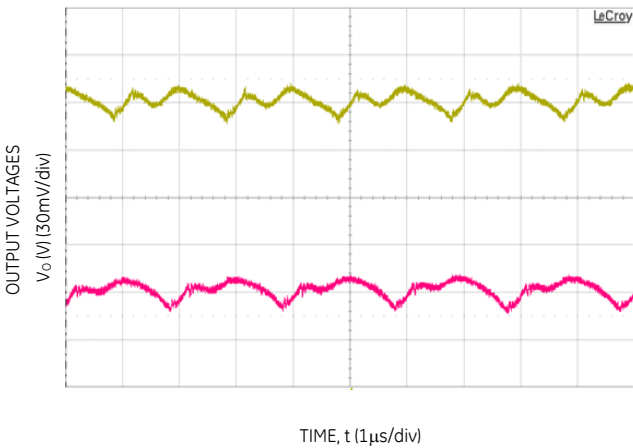

Figure 15. Typical output ripple and noise (C_O= 2×4.7nF+2×47µF ceramic, V_{IN} = 12V, I_o = I_{o1,max}, I_{o2,max}).

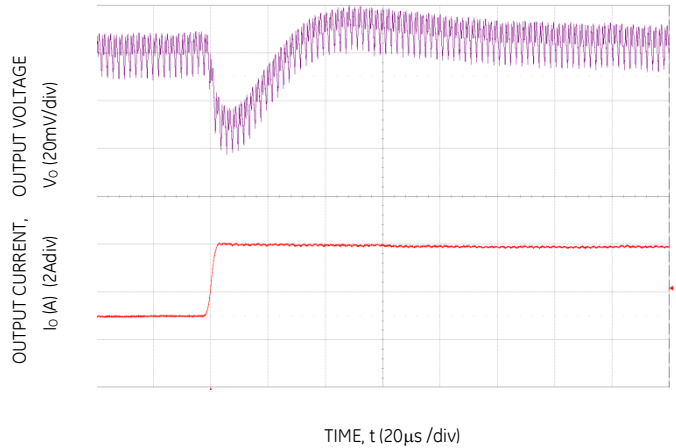

Figure 16. Transient Response to Dynamic Load Change on one output from 50% to 100% at 12Vin, C_{out} = 3×47µF+1×330µF, C_{Tune} = 1800pF & R_{Tune} = 300Ω

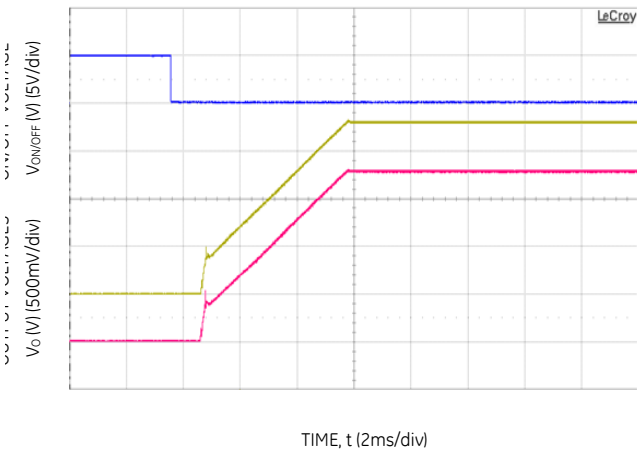

Figure 17. Typical Start-up Using On/Off Voltage (V_{IN} = 12V, I_o = I_{o1,max}, I_{o2,max}).

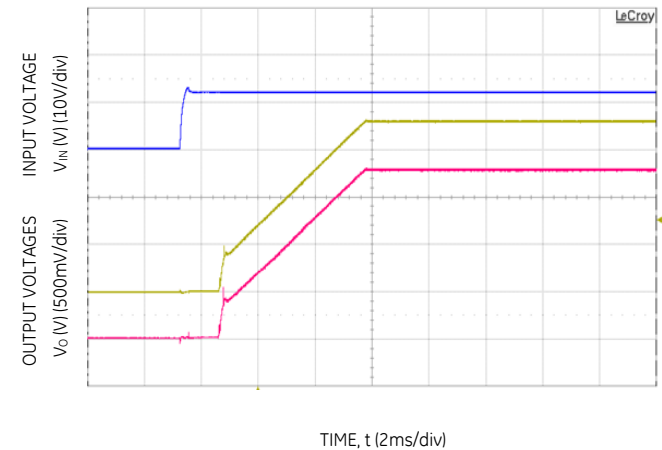

Figure 18. Typical Start-up Using Input Voltage (V_{IN} = 12V, I_o = I_{o1,max}, I_{o2,max}).

2 × 6A Digital Dual MicroDlynx™: Non-Isolated DC-DC Power Modules

4.5Vdc – 14.4Vdc input; 0.51Vdc to 5.5Vdc output; 2 × 6A Output Current

Characteristic Curves

The following figures provide typical characteristics for the 2 × 6A Digital Dual MicroDlynx™ at 2.5Vo and 25°C.

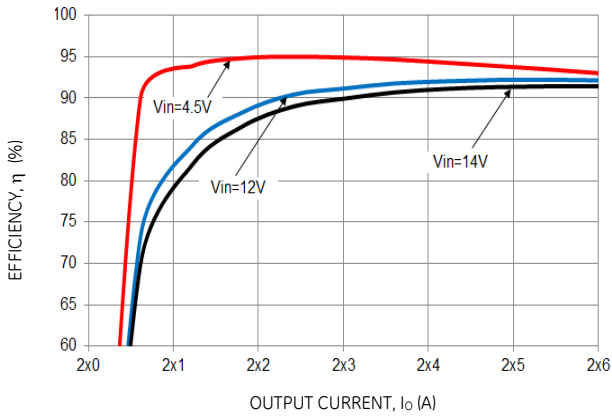

Figure 19. Converter Efficiency versus Output Current.

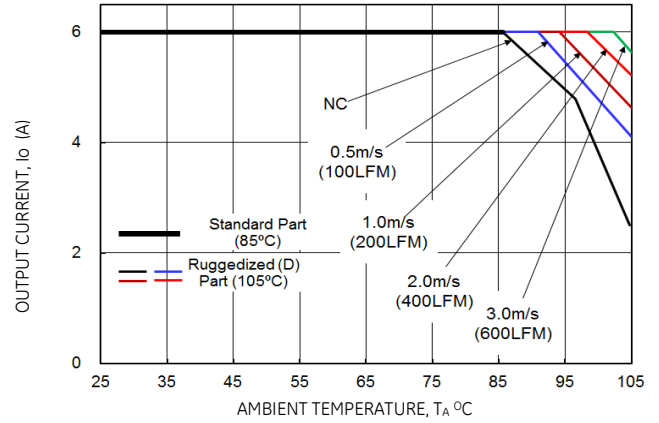

Figure 20. Derating Output Current versus Ambient Temperature and Airflow.

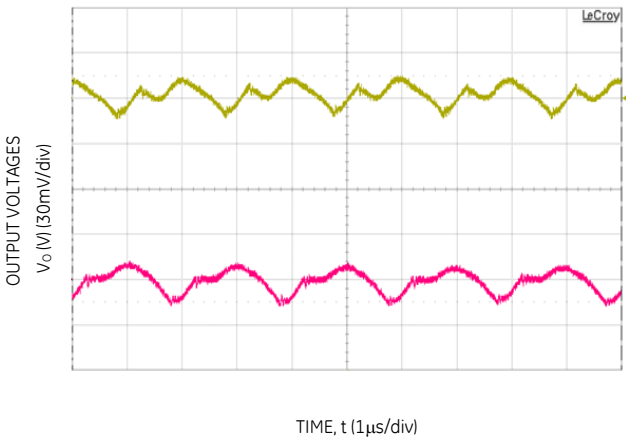

Figure 21. Typical output ripple and noise (C_O = 2x4.7nF+2x47uF ceramic, V_{IN} = 12V, I_o = I_{o1,max}, I_{o2,max}).

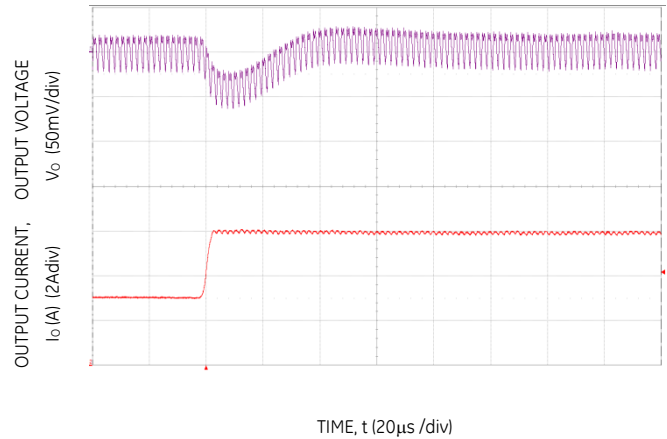

Figure 22. Transient Response to Dynamic Load Change on one output from 50% to 100% at 12Vin, Cout = 2x47uF + 1x330uF, CTune = 1500pF & RTune = 300Ω

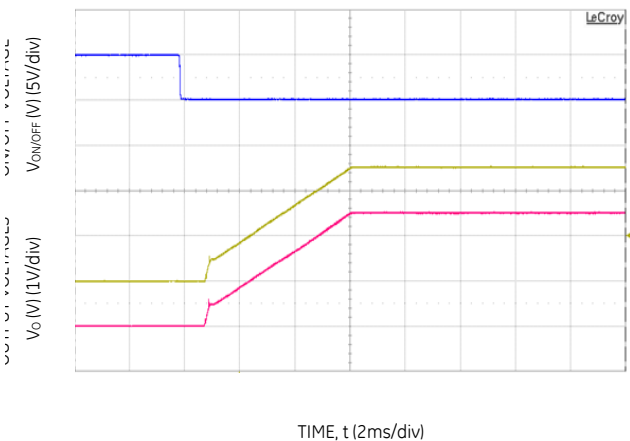

Figure 23. Typical Start-up Using On/Off Voltage (V_{IN} = 12V, I_o = I_{o1,max}, I_{o2,max}).

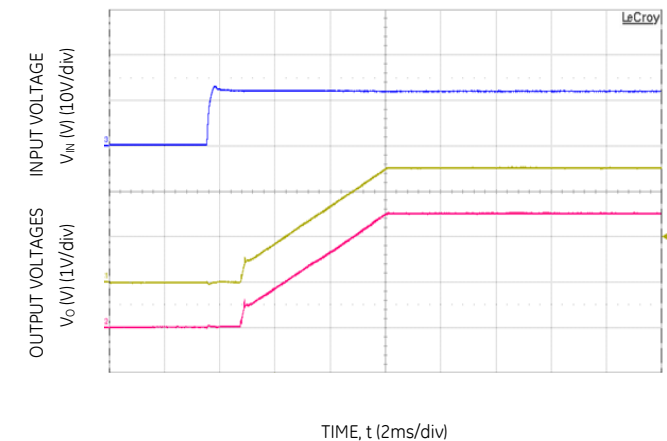

Figure 24. Typical Start-up Using Input Voltage (V_{IN} = 12V, I_o = I_{o1,max}, I_{o2,max}).

2 × 6A Digital Dual MicroDlynx™: Non-Isolated DC-DC Power Modules

4.5Vdc – 14.4Vdc input; 0.51Vdc to 5.5Vdc output; 2 × 6A Output Current

Characteristic Curves

The following figures provide typical characteristics for the 2 × 6A Digital Dual MicroDlynx™ at 3.3V_o and 25°C.

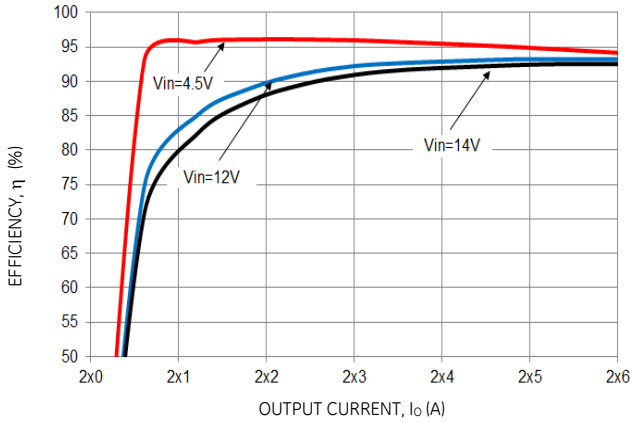

Figure 25. Converter Efficiency versus Output Current.

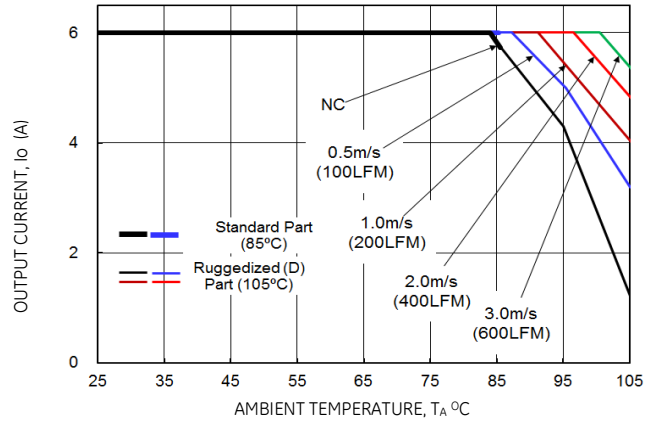

Figure 26. Derating Output Current versus Ambient Temperature and Airflow.

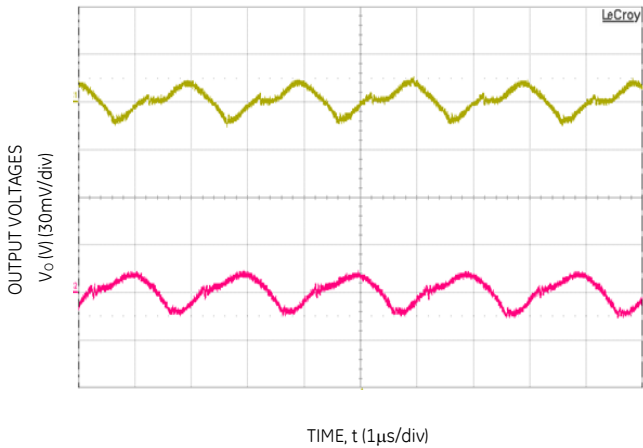

Figure 27. Typical output ripple and noise (C_O= 2x4.7nF+2x47µF ceramic, V_{IN} = 12V, I_o = I_{o1,max}, I_{o2,max}).

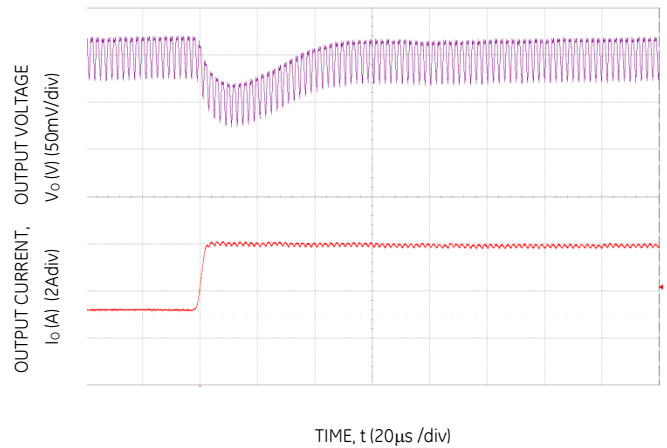

Figure 28 Transient Response to Dynamic Load Change on one output from 50% to 100% at 12V_{in}, C_{out} = 2x47µF+1x330µF, C_{Tune} = 1200pF & R_{Tune} = 300Ω

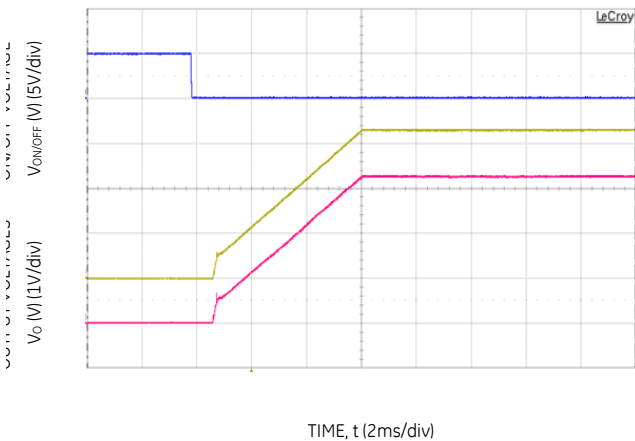

Figure 29. Typical Start-up Using On/Off Voltage (V_{IN} = 12V, I_o = I_{o1,max}, I_{o2,max}).

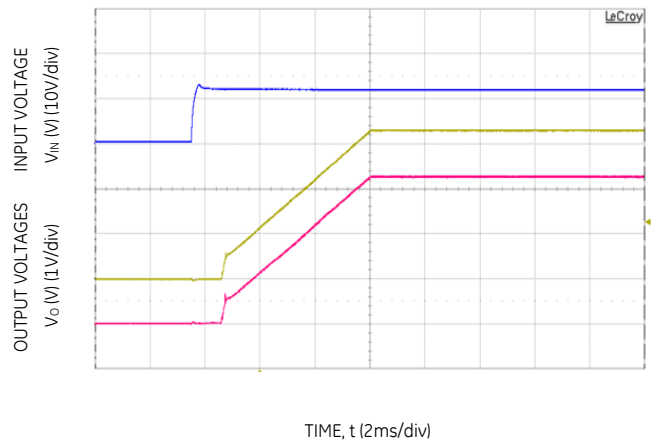

Figure 30. Typical Start-up Using Input Voltage (V_{IN} = 12V, I_o = I_{o1,max}, I_{o2,max}).

2 × 6A Digital Dual MicroDlynx™: Non-Isolated DC-DC Power Modules

4.5Vdc – 14.4Vdc input; 0.51Vdc to 5.5Vdc output; 2 × 6A Output Current

Characteristic Curves

The following figures provide typical characteristics for the 2 × 6A Digital Dual MicroDlynx™ at 5Vo and 25°C.

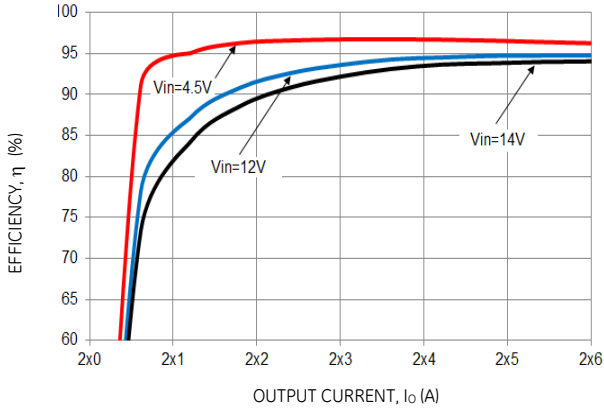

Figure 31. Converter Efficiency versus Output Current.

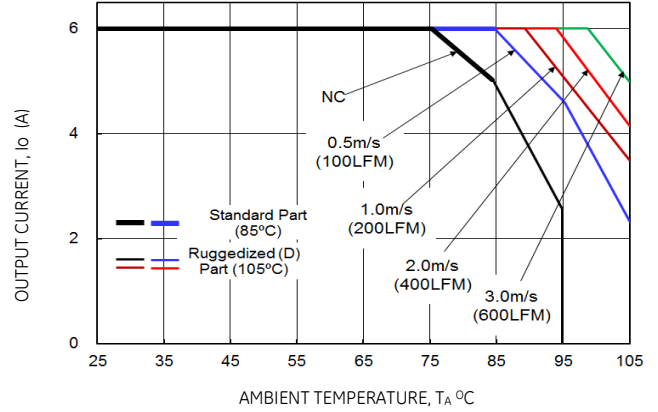

Figure 32. Derating Output Current versus Ambient Temperature and Airflow.

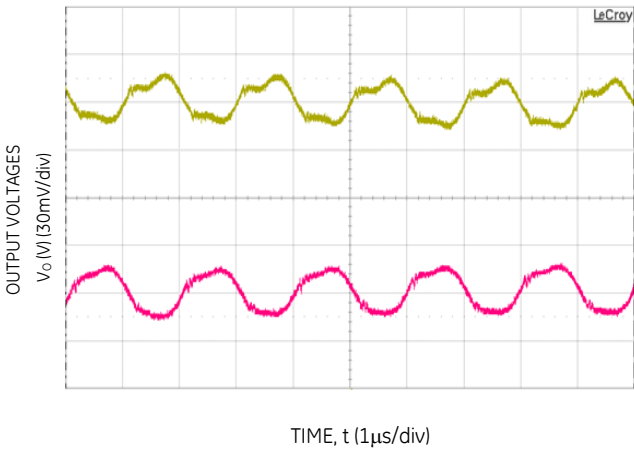

Figure 33. Typical output ripple and noise ($C_o = 2 \times 4.7nF + 2 \times 47\mu F$ ceramic, $V_{IN} = 12V$, $I_o = I_{o1,max}, I_{o2,max}$).

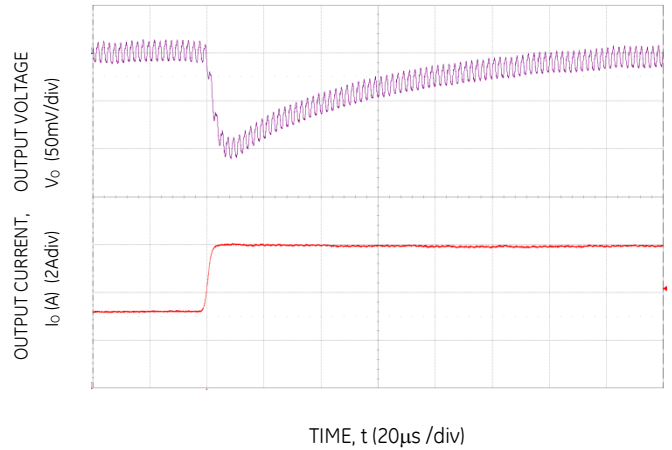

Figure 34. Transient Response to Dynamic Load Change on one output from 50% to 100% at 12Vin, $C_{out} = 4 \times 47\mu F$, $C_{Tune} = 470pF$ & $R_{Tune} = 300\Omega$

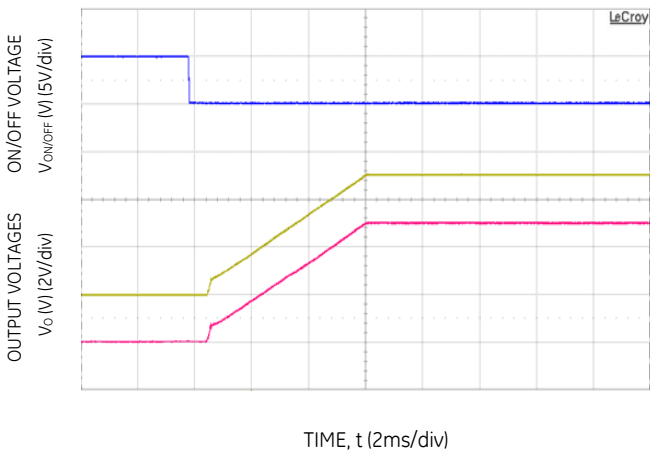

Figure 35. Typical Start-up Using On/Off Voltage ($V_{IN} = 12V$, $I_o = I_{o1,max}, I_{o2,max}$).

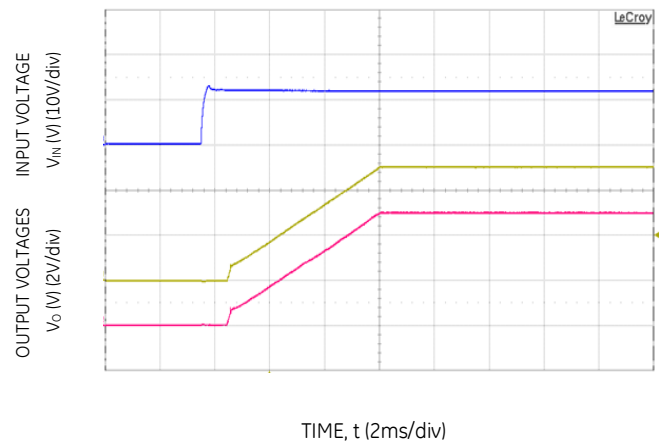

Figure 36. Typical Start-up Using Input Voltage ($V_{IN} = 12V$, $I_o = I_{o1,max}, I_{o2,max}$).

2 × 6A Digital Dual MicroDlynx™: Non-Isolated DC-DC Power Modules

4.5Vdc –14.4Vdc input; 0.51Vdc to 5.5Vdc output; 2 × 6A Output Current

Design Considerations

Input Filtering

The 2 × 6A Digital Dual MicroDlynx™ module should be connected to a low ac-impedance source. A highly inductive source can affect the stability of the module. An input capacitance must be placed directly adjacent to the input pin of the module, to minimize input ripple voltage and ensure module stability.

To minimize input voltage ripple, ceramic capacitors are recommended at the input of the module. Figure 37 shows the input ripple voltage for various output voltages at 2 × 6A of load current with 2x22 μF or 4x22 μF ceramic capacitors and an input of 12V.

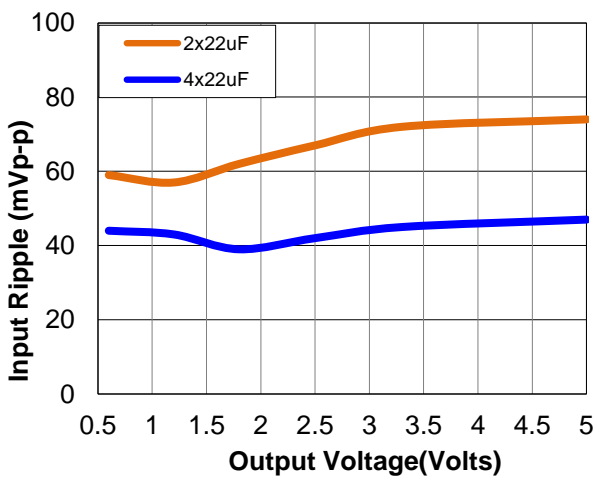

Figure 37. Input ripple voltage for various output voltages with 2x22 μF or 4x22 μF ceramic capacitors at the input (2 × 6A load). Input voltage is 12V. Scope BW: 20MHz

Output Filtering

These modules are designed for low output ripple voltage and will meet the maximum output ripple specification with 0.1 μF ceramic and 22 μF ceramic capacitors at the output of the module. However, additional output filtering may be required by the system designer for a number of reasons. First, there may be a need to further reduce the output ripple and noise of the module. Second, the dynamic response characteristics may need to be customized to a particular load step change.

To reduce the output ripple and improve the dynamic response to a step load change, additional capacitance at the output can be used. Low ESR polymer and ceramic capacitors are recommended to improve the dynamic response of the module. Figure 38 provides output ripple information for different external capacitance values at various Vo and a full load current of 2 × 6A. For stable operation of the module, limit the capacitance to less than the maximum output capacitance as specified in the electrical specification table. Optimal performance of the module can be achieved by using the Tunable Loop™ feature described later in this data sheet.

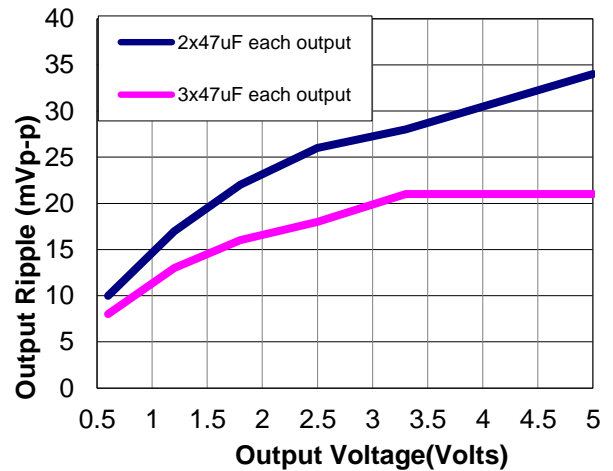

Figure 38. Output ripple voltage for various output voltages with total external 4x47 μF or 6x47 μF ceramic capacitors at the output (2 × 6A load). Input voltage is 12V. Scope BW: 20MHz

Safety Considerations

For safety agency approval the power module must be installed in compliance with the spacing and separation requirements of the end-use safety agency standards, i.e., UL 60950-1 2nd, CSA C22.2 No. 60950-1-07, DIN EN 60950-1:2006 + A11 (VDE0805 Teil 1 + A11):2009-11; EN 60950-1:2006 + A11:2009-03.

For the converter output to be considered meeting the requirements of safety extra-low voltage (SELV), the input must meet SELV requirements. The power module has extra-low voltage (ELV) outputs when all inputs are ELV.

The input to these units is to be provided with a fast-acting fuse with a maximum rating of 15 A in the positive input lead.

2 × 6A Digital Dual MicroDlynx™: Non-Isolated DC-DC Power Modules

4.5Vdc –14.4Vdc input; 0.51Vdc to 5.5Vdc output; 2 × 6A Output Current

Analog Feature Descriptions

Remote On/Off

The module can be turned ON and OFF either by using the ON/OFF pin (Analog interface) or through the PMBus interface (Digital). The module can be configured in a number of ways through the PMBus interface to react to the two ON/OFF inputs:

- Module ON/OFF can be controlled only through the analog interface (digital interface ON/OFF commands are ignored)
- Module ON/OFF can be controlled only through the PMBus interface (analog interface is ignored)
- Module ON/OFF can be controlled by either the analog or digital interface

The default state of the module (as shipped from the factory) is to be controlled by the analog interface only. If the digital interface is to be enabled, or the module is to be controlled only through the digital interface, this change must be made through the PMBus. These changes can be made and written to non-volatile memory on the module so that it is remembered for subsequent use.

Analog On/Off

The 2 × 6A Digital Dual MicroDlynx™ power modules feature an On/Off pin for remote On/Off operation. Two On/Off logic options are available. In the Positive Logic On/Off option, (device code suffix “4” – see Ordering Information), the module turns ON during a logic High on the On/Off pin and turns OFF during a logic Low. With the Negative Logic On/Off option, (no device code suffix, see Ordering Information), the module turns OFF during logic High and ON during logic Low. The On/Off signal should be always referenced to ground. For either On/Off logic option, leaving the On/Off pin disconnected will turn the module ON when input voltage is present.

For positive logic modules, the circuit configuration for using the On/Off pin is shown in Figure 39. When the external transistor is in the OFF state, the internal transistor Q1 is turned ON, and the internal PWM Enable# signal (normally low) is pulled low causing the module to be ON. When ext. transistor is turned ON, the On/Off pin is pulled low, and the internal PWM Enable# signal (normally low) is pulled high and the module is OFF. For negative logic On/Off modules, the circuit configuration is shown in Fig. 40. When external transistor is in the OFF state, the On/Off pin is pulled high, transistor Q1 is turned ON and the internal PWM Enable signal is pulled low and the module is OFF. To turn the module ON, the external transistor is turned ON pulling the On/Off pin low, turning transistor Q1 OFF resulting in the PWM Enable pin going high and the module turns ON

Digital On/Off

Please see the Digital Feature Descriptions section.

Output 1

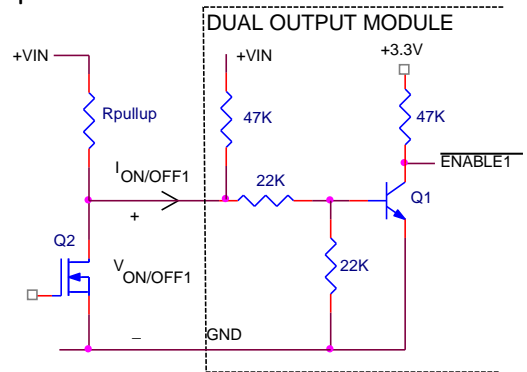

Output 2

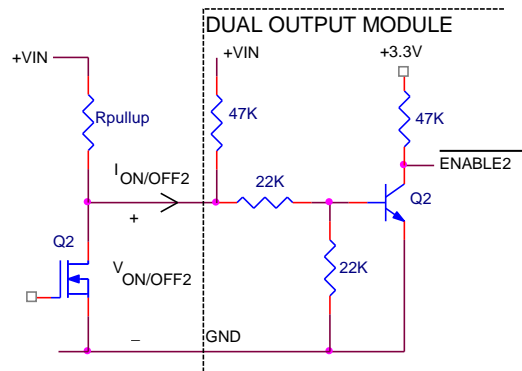
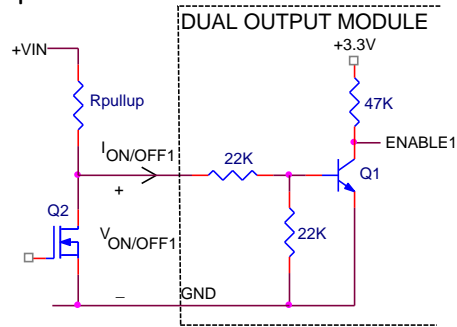

Figure 39. Circuit configuration for using positive On/Off logic.

Output 1



Output 2

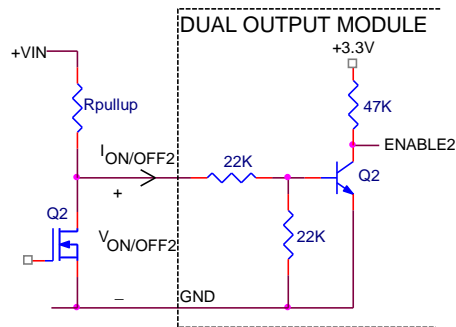

Figure 40. Circuit configuration for using negative On/Off logic.

2 × 6A Digital Dual MicroDlynx™: Non-Isolated DC-DC Power Modules

4.5Vdc –14.4Vdc input; 0.51Vdc to 5.5Vdc output; 2 × 6A Output Current

Monotonic Start-up and Shutdown

The module has monotonic start-up and shutdown behavior for any combination of rated input voltage, output current and operating temperature range.

Startup into Pre-biased Output

The module can start into a prebiased output on either or both outputs as long as the prebias voltage is 0.5V less than the set output voltage.

Analog Output Voltage Programming

The output voltage of each output of the module can be programmable to any voltage from 0.6dc to 5.5Vdc by connecting a resistor between the 2 Trims and SIG_GND pins of the module. Certain restrictions apply on the output voltage set point depending on the input voltage. These are shown in the Output Voltage vs. Input Voltage Set Point Area plot in Fig. 1. The Upper Limit curve shows that for output voltages lower than 1V, the input voltage must be lower than the maximum of 14.4V. If the module can operate at 14.4V below 1V then that is preferable over the existing upper curve. The Lower Limit curve shows that for output voltages higher than 0.6V, the input voltage needs to be larger than the minimum of 4.5V.

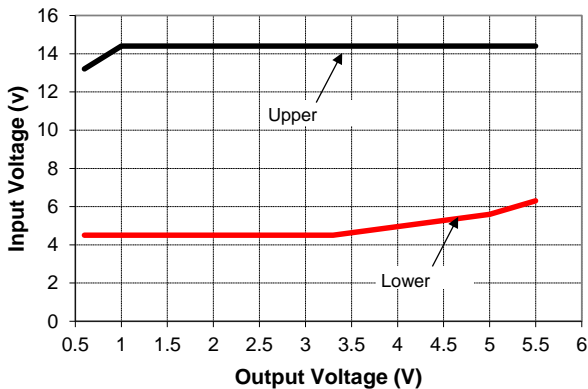
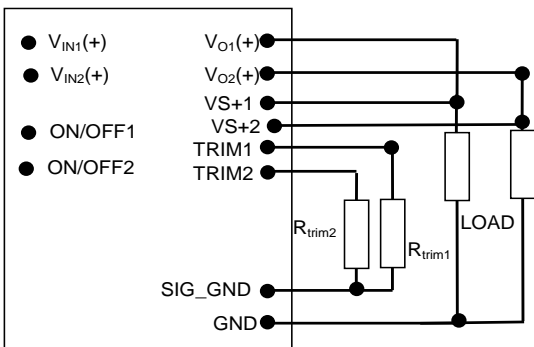

Figure 41. Output Voltage vs. Input Voltage Set Point Area plot showing limits where the output voltage can be set for different input voltages.



Caution – Do not connect SIG_GND to GND elsewhere in the layout

Figure 42. Circuit configuration for programming output voltage using an external resistor.

Without an external resistor between Trim and SIG_GND pins, each output of the module will be 0.6Vdc. To calculate the value of the trim resistor, R_{trim} for a desired output voltage, should be as per the following equation:

$$R_{trim} = \left[\frac{12}{(V_o - 0.6)} \right] k\Omega$$

R_{trim} is the external resistor in $k\Omega$

V_o is the desired output voltage.

Table 1 provides R_{trim} values required for some common output voltages.

Table 1

$V_{o, set}$ (V)	R_{trim} (k Ω)
0.6	Open
0.9	40
1.0	30
1.2	20
1.5	13.33
1.8	10
2.5	6.316
3.3	4.444
5.0	2.727

Digital Output Voltage Adjustment

Please see the Digital Feature Descriptions section.

Remote Sense

The power module has a Remote Sense feature to minimize the effects of distribution losses by regulating the voltage between the sense pins (VS+ and VS-) for each of the 2 outputs. The voltage drop between the sense pins and the VOUT and GND pins of the module should not exceed 0.5V. If there is an inductor being used on the module output, then the tunable loop feature of the module should be used to ensure module stability with the proposed sense point location. If the simulation tools and loop feature of the module are not being used, then the remote sense should always be connected before the inductor. The sense trace should also be kept away from potentially noisy areas of the board

Analog Voltage Margining

Output voltage margining can be implemented in the module by connecting a resistor, $R_{margin-up}$, from the Trim pin to the ground pin for margining-up the output voltage and by connecting a resistor, $R_{margin-down}$, from the Trim pin to output pin for margining-down. Figure 43 shows the circuit configuration for output voltage margining. The POL Programming Tool, available at www.gecriticalpower.com under the Downloads section, also calculates the values of $R_{margin-up}$ and $R_{margin-down}$ for a specific output voltage and %

2 × 6A Digital Dual MicroDlynx™: Non-Isolated DC-DC Power Modules

4.5Vdc –14.4Vdc input; 0.51Vdc to 5.5Vdc output; 2 × 6A Output Current

margin. Please consult your local GE technical representative for additional details.

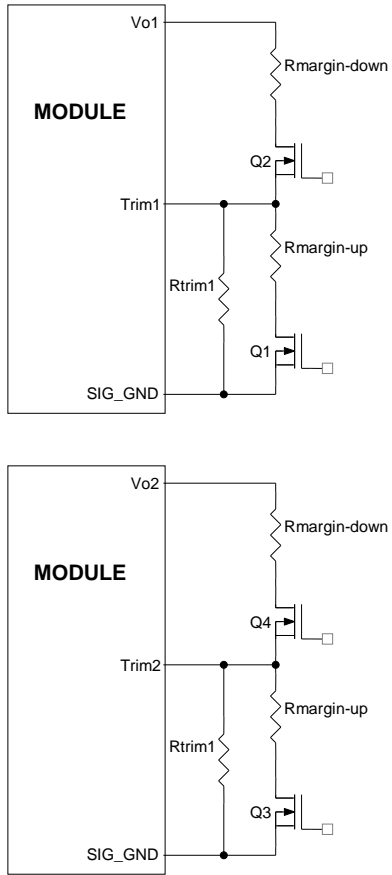

Figure 43. Circuit Configuration for margining Output voltage.

Digital Output Voltage Margining

Please see the Digital Feature Descriptions section.

Overcurrent Protection

To provide protection in a fault (output overload) condition, the unit is equipped with internal current-limiting circuitry on both outputs and can endure current limiting continuously. At the point of current-limit inception, the unit enters hiccup mode. The unit operates normally once the output current is brought back into its specified range.

Digital Adjustable Overcurrent Warning

Please see the Digital Feature Descriptions section.

Overtemperature Protection

To provide protection in a fault condition, the unit is equipped with a thermal shutdown circuit. The unit will shut down if the overtemperature threshold of 135°C(typ) is exceeded at the thermal reference point T_{ref} . Once the unit goes into thermal shutdown it will then wait to cool before attempting to restart.

Digital Temperature Status via PMBus

Please see the Digital Feature Descriptions section.

Digitally Adjustable Output Over and Under Voltage Protection

Please see the Digital Feature Descriptions section.

Input Undervoltage Lockout

At input voltages below the input undervoltage lockout limit, the module operation is disabled. The module will begin to operate at an input voltage above the undervoltage lockout turn-on threshold.

Digitally Adjustable Input Undervoltage Lockout

Please see the Digital Feature Descriptions section.

Digitally Adjustable Power Good Thresholds

Please see the Digital Feature Descriptions section.

Synchronization

The module switching frequency can be synchronized to a signal with an external frequency within a specified range. Synchronization can be done by using the external signal applied to the SYNC pin of the module as shown in Fig. 45, with the converter being synchronized by the rising edge of the external signal. The Electrical Specifications table specifies the requirements of the external SYNC signal. If the SYNC pin is not used, the module should free run at the default switching frequency. **If synchronization is not being used, connect the SYNC pin to GND.**

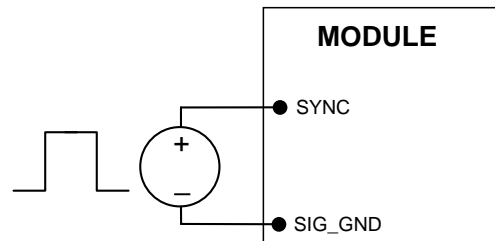

Figure 45. External source connections to synchronize switching frequency of the module.

Measuring Output Current, Output Voltage and Input Voltage

Please see the Digital Feature Descriptions section.

Tunable Loop™

The module has a feature that optimizes transient response of the module called Tunable Loop™.

External capacitors are usually added to the output of the module for two reasons: to reduce output ripple and noise (see Figure 38) and to reduce output voltage deviations from the steady-state value in the presence of dynamic load current changes. Adding external capacitance however affects the voltage control loop of the module, typically causing the loop to slow down with sluggish response. Larger values of external capacitance could also cause the module to become unstable.

2 × 6A Digital Dual MicroDlynx™: Non-Isolated DC-DC Power Modules

4.5Vdc –14.4Vdc input; 0.51Vdc to 5.5Vdc output; 2 × 6A Output Current

The Tunable Loop™ allows the user to externally adjust the voltage control loop to match the filter network connected to the output of the module. The Tunable Loop™ is implemented by connecting a series R-C between the VS+ and TRIM pins of the module, as shown in Fig. 47. This R-C allows the user to externally adjust the voltage loop feedback compensation of the module.

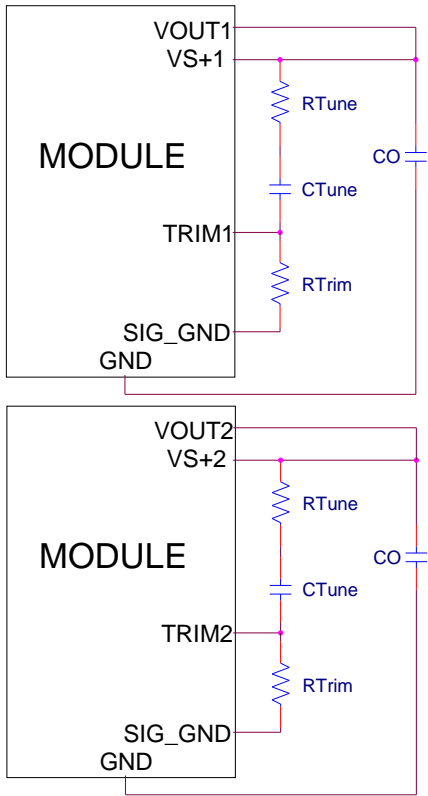

Figure. 47. Circuit diagram showing connection of R_{TUNE} and C_{TUNE} to tune the control loop of the module.

Recommended values of R_{TUNE} and C_{TUNE} for different output capacitor combinations are given in Table 2. Table 2 shows the recommended values of R_{TUNE} and C_{TUNE} for different values of ceramic output capacitors up to 1000uF that might be needed for an application to meet output ripple and noise requirements. Selecting R_{TUNE} and C_{TUNE} according to Table 2 will ensure stable operation of the module. In applications with tight output voltage limits in the presence of dynamic current loading, additional output capacitance will be required. Table 3 lists recommended values of R_{TUNE} and C_{TUNE} in order to meet 2% output voltage deviation limits for some common output voltages in the presence of a 3A to 6A step change (50% of full load), with an input voltage of 12V.

Please contact your GE technical representative to obtain more details of this feature as well as for guidelines on how to select the right value of external R-C to tune the module for best transient performance and stable operation for other output capacitance values.

Table 2. General recommended values of R_{TUNE} and C_{TUNE} for $V_{in}=12V$ and various external ceramic capacitor combinations.

Co	2x47µF	4x47µF	6x47µF	10x47µF	20x47µF
R_{TUNE}	300	300	300	300	300
C_{TUNE}	220pF	1000pF	1500pF	2700pF	3900pF

Table 3. Recommended values of R_{TUNE} and C_{TUNE} to obtain transient deviation of 2% of V_{out} for a 6A step load with $V_{in}=12V$.

V_o	5V	3.3V	2.5V	1.8V	1.2V	0.6V
Co	4x47µF	2x47µF + 330µF Polymer	2x47µF + 1x330µF Polymer	3x47µF + 1x330µF Polymer	3x47µF + 2x330µF Polymer	3x47µF + 3x330µF Polymer
R_{TUNE}	300	300	300	300	300	300
C_{TUNE}	470pF	1500pF	1500pF	1800pF	2700pF	12nF
ΔV	69mV	31mV	30mV	27mV	18mV	9mV

Note: The capacitors used in the Tunable Loop tables are 47 µF/2 mΩ ESR ceramic and 330 µF/9 mΩ ESR polymer capacitors.

2 × 6A Digital Dual MicroDlynx™: Non-Isolated DC-DC Power Modules

4.5Vdc –14.4Vdc input; 0.51Vdc to 5.5Vdc output; 2 × 6A Output Current

Digital Feature Descriptions

PMBus Interface Capability

The 2 × 6A Digital Dual MicroDlynx™ power modules have a PMBus interface that supports both communication and control. The PMBus Power Management Protocol Specification can be obtained from www.pmbus.org. The modules support a subset of version 1.1 of the specification (see Table 6 for a list of the specific commands supported). Most module parameters can be programmed using PMBus and stored as defaults for later use.

All communication over the module PMBus interface must support the Packet Error Checking (PEC) scheme. The PMBus master must generate the correct PEC byte for all transactions, and check the PEC byte returned by the module.

The module also supports the SMBALERT# response protocol whereby the module can alert the bus master if it wants to talk. For more information on the SMBus alert response protocol, see the System Management Bus (SMBus) specification.

The module has non-volatile memory that is used to store configuration settings. Not all settings programmed into the device are automatically saved into this non-volatile memory, only those specifically identified as capable of being stored can be saved (see Table 6 for which command parameters can be saved to non-volatile storage).

PMBus Data Format

For commands that set thresholds, voltages or report such quantities, the module supports the “Linear” data format among the three data formats supported by PMBus. The Linear Data Format is a two byte value with an 11-bit, two’s complement mantissa and a 5-bit, two’s complement exponent. The format of the two data bytes is shown below:

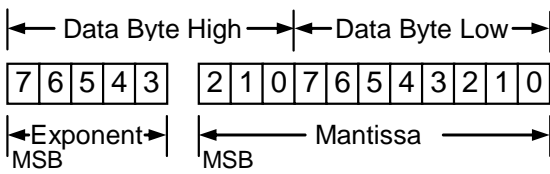

The value of the number is then given by

$$\text{Value} = \text{Mantissa} \times 2^{\text{Exponent}}$$

PMBus Addressing

The power module can be addressed through the PMBus using a device address. The module has 64 possible addresses (0 to 63 in decimal) which can be set using resistors connected from the ADDR0 and ADDR1 pins to SIG_GND. Note that some of these addresses (0, 1, 2, 3, 4, 5, 6, 7, 8, 9, 10, 11, 12, 40, 44, 45, 55 in decimal) are reserved according to the SMBus specifications and may not be useable. The address is set in the form of two octal (0 to 7) digits, with each pin setting one digit. The ADDR1 pin sets the high order digit and ADDR0 sets the low order digit. The resistor values suggested for each digit are shown in Table 4 (1% tolerance resistors are recommended). Note that if

either address resistor value is outside the range specified in Table 4, the module will respond to address 127.

Table 4

Digit	Resistor Value (KΩ)
0	11
1	18.7
2	27.4
3	38.3
4	53.6
5	82.5
6	127
7	187

The user must know which I²C addresses are reserved in a system for special functions and set the address of the module to avoid interfering with other system operations. Both 100kHz and 400kHz bus speeds are supported by the module. Connection for the PMBus interface should follow the High Power DC specifications given in section 3.1.3 in the SMBus specification V2.0 for the 400kHz bus speed or the Low Power DC specifications in section 3.1.2. The complete SMBus specification is available from the SMBus web site, smbus.org.

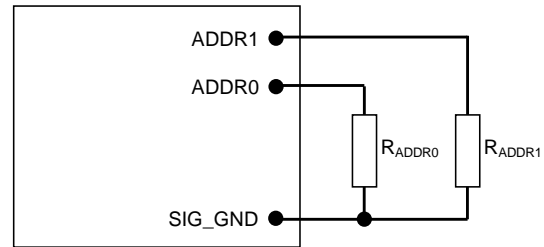

Figure 48. Circuit showing connection of resistors used to set the PMBus address of the module.

PAGE

Both the outputs of the module can be configured, controlled and monitored through only one physical address

Format	Unsigned Binary							
Bit Position	7	6	5	4	3	2	1	0
Access	r/w	r	r	r	r	r	r	r/w
Function	PA	X	X	X	X	X	X	P0
Default Value	0	X	X	X	X	X	X	0

PAGE Command Truth Table

PA	P0	Logic Results
0	0	All Commands address first output
0	1	All Commands address second output
1	0	Illegal input, Ignore write
1	1	All Commands address both outputs

If PAGE=11, then any read commands affect the first channel. Any value to ready-only registers is ignored.

2 × 6A Digital Dual MicroDlynx™: Non-Isolated DC-DC Power Modules

4.5Vdc –14.4Vdc input; 0.51Vdc to 5.5Vdc output; 2 × 6A Output Current

Operation (01h)

This is a paged register. The OPERATION command can be used to turn the module on or off in conjunction with the ON/OFF pin input. It is also used to margin up or margin down the output voltage

PMBus Enabled On/Off

The module can also be turned on and off via the PMBus interface. The OPERATION command is used to actually turn the module on and off via the PMBus, while the ON_OFF_CONFIG command configures the combination of analog ON/OFF pin input and PMBus commands needed to turn the module on and off. Bit [7] in the OPERATION command data byte enables the module, with the following functions:

- 0 : Output is disabled
- 1 : Output is enabled

This module uses the lower five bits of the ON_OFF_CONFIG data byte to set various ON/OFF options as follows:

Bit Position	4	3	2	1	0
Access	r/w	r/w	r/w	r	r
Function	PU	CMD	CPR	POL	CPA
Default Value	1	0	1	1	0

PU: Sets the default to either operate any time input power is present or for the ON/OFF to be controlled by the analog ON/OFF input and the PMBus OPERATION command. This bit is used together with the CP, CMD and ON bits to determine startup.

Bit Value	Action
0	Module powers up any time power is present regardless of state of the analog ON/OFF pin
1	Module does not power up until commanded by the analog ON/OFF pin and the OPERATION command as programmed in bits [2:0] of the ON_OFF_CONFIG register.

CMD: The CMD bit controls how the device responds to the OPERATION command.

Bit Value	Action
0	Module ignores the ON bit in the OPERATION command
1	Module responds to the ON bit in the OPERATION command

CPR: Sets the response of the analog ON/OFF pin. This bit is used together with the CMD, PU and ON bits to determine startup.

Bit Value	Action
0	Module ignores the analog ON/OFF pin, i.e. ON/OFF is only controlled through the PMBUS via the OPERATION command
1	Module requires the analog ON/OFF pin to be asserted to start the unit

CPA: Sets the action of the analog ON/OFF pin when turning the controller OFF. This bit is internally read and cannot be modified by the user

PMBus Adjustable Soft Start Rise Time

The soft start rise time can be adjusted in the module via PMBus. When setting this parameter, make sure that the charging current for output capacitors can be delivered by the module in addition to any load current to avoid nuisance tripping of the overcurrent protection circuitry during startup. The TON_RISE command sets the rise time in ms, and allows choosing soft start times between 600µs and 9ms, with possible values listed in Table 5. Note that the exponent is fixed at -4 (decimal) and the upper two bits of the mantissa are also fixed at 0.

Table 5

Rise Time	Exponent	Mantissa
600µs	11100	00000001010
900µs	11100	00000001110
1.2ms	11100	00000010011
1.8ms	11100	00000011101
2.7ms	11100	00000101011
4.2ms	11100	00001000011
6.0ms	11100	00001100000
9.0ms	11100	00010010000

Output Voltage Adjustment Using the PMBus

The VREF_TRIM parameter is important for a number of PMBus commands related to output voltage trimming, and margining. Each of the 2 output voltages of the module can be set as the combination of the voltage divider formed by RTrim and a 20kΩ upper divider resistor inside the module, and the internal reference voltage of the module. The reference voltage VREF shall be nominally set at 600mV, and the output regulation voltage is then given by

$$V_{OUT.1} = \left[\frac{20000 + RTrim1}{RTrim1} \right] \times V_{REF}$$

$$V_{OUT.2} = \left[\frac{20000 + RTrim2}{RTrim2} \right] \times V_{REF}$$

Hence the module output voltages shall be dependent on the value of RTrim1 and Rtrim2 which are connected external to the module.

The VREF_TRIM parameter is used to apply a fixed offset voltage to the reference voltage can be specified using the

2 × 6A Digital Dual MicroDlynx™: Non-Isolated DC-DC Power Modules

4.5Vdc –14.4Vdc input; 0.51Vdc to 5.5Vdc output; 2 × 6A Output Current

“Linear” format and two bytes. The exponent is fixed at –9 (decimal). The resolution of the adjustment is 7 bits, with a resulting step size of approximately 0.4%. The maximum trim range is –20% to +10% of the nominal reference voltage (600mV) in 2mV steps. Permissible values range from –120mV to +60mV

When PMBus commands are used to trim or margin the output voltage, the value of V_{REF} is what is changed inside the module, which in turn changes the regulated output voltage of the module.

The nominal output voltage of the module can be adjustable with a minimum step size of 0.4% over a +10% to –20% range from nominal using the V_{REF_TRIM} command over the PMBus.

The V_{REF_TRIM} command can be used to apply a fixed offset voltage to either of the output voltage command value using the “Linear” mode with the exponent fixed at –9 (decimal). The value of the offset voltage shall be given by

$$V_{REF(offset)} = V_{REF_TRIM} \times 2^{-9}$$

This offset voltage shall be added to the voltage set through the divider ratio and nominal V_{REF} to produce the trimmed output voltage. If a value outside of the +10%/–20% adjustment range is given with this command, the module will set its output voltage to the upper or lower limit value (as if V_{OUT_TRIM} , assert $SMBALRT\#$, set the CML bit in $STATUS_BYTE$ and the invalid data bit in $STATUS_CML$).

Applications Example

For a design where the output voltage is 1.8V and the output needs to be trimmed down by 20mV.

- The internal reference voltage is 0.6V. So we need to determine how the 20mV translates to a change in the internal reference voltage.
- Divider Ratio = $V_{ref}/V_{out} = 0.6/1.8 = 0.33$
- Hence a 20mV change at 1.8V requires a $0.33 \times 20mV = 6.6mV$ change in the reference voltage.
- $V_{ref(offset)} = -(6.6)/1000 = -0.0066$ Volts (- sign since we are trimming down)
- $V_{ref(offset)} = V_{ref_Trim} \times 2^{-9}$
- $V_{ref_Trim} = V_{ref(offset)} \times 512$
- $V_{ref_Trim} = -0.0066 \times 512 = -3.3 = -3$ (rounded to nearest integer)

Output Voltage Margining Using the PMBus

Each output of the module can also have its output voltage margined via PMBus commands. The command $STEP_V_{REF_MARGIN_HIGH}$ shall set the margin high voltage, while the command $STEP_V_{REF_MARGIN_LOW}$ sets the margin low voltage. Both the $STEP_V_{REF_MARGIN_HIGH}$ and $STEP_V_{REF_MARGIN_LOW}$ commands shall use the “Linear” mode with the exponent fixed at –9 (decimal). Two bytes shall be used for the mantissa with the upper bit [7] of the high byte shall be fixed at 0. The actual margined output voltage shall be a combination of the $STEP_V_{REF_MARGIN_HIGH}$ or $STEP_V_{REF_MARGIN_LOW}$ and the V_{REF_TRIM} values as shown below. The net permissible voltage range change shall be –30% to +10% for

the margin high command and –20% to 0% for the margin low command

$$V_{REF(MH)} = (STEP_V_{REF_MARGIN_HIGH} + V_{REF_TRIM}) \times 2^{-9}$$

Applications Example

For a design where the output voltage is 1.2V and the output needs to be trimmed up by 100mV (within 10% of V_o).

- The internal reference voltage is 0.6V. So we need to determine how the 100mV translates to a change in the internal reference voltage.
- Divider Ratio = $V_{ref}/V_{out} = 0.6/1.2 = 0.5$
- Hence a 100mV change at 1.2V requires a $0.5 \times 100mV = 50mV$ change in the reference voltage.
- $V_{REF(MH)} = (50)/1000 = 0.05$ Volts
- $V_{REF(MH)} = (STEP_V_{ref_margin_high} + V_{ref_trim}) \times 2^{-9}$
- Assume $V_{ref_Trim} = 0$ here
- $STEP_V_{ref_margin_high} = V_{REF(MH)} \times 512$
- $STEP_V_{ref_margin_high} = 0.05 \times 512 = 26$ (rounded to nearest integer)

$$V_{REF(ML)} =$$

$$(STEP_V_{REF_MARGIN_LOW} + V_{REF_TRIM}) \times 2^{-9}$$

Applications Example

For a design where the output voltage is 1.8V and the output needs to be trimmed down by 100mV (within –20% of V_o).

- The internal reference voltage is 0.6V. So we need to determine how the 100mV translates to a change in the internal reference voltage.
- Divider Ratio = $V_{ref}/V_{out} = 0.6/1.8 = 0.33$
- Hence a 100mV change at 1.8V requires a $0.33 \times 100mV = 33mV$ change in the reference voltage.
- $V_{REF(ML)} = -(33)/1000 = -0.033$ Volts (- sign since we are margining down)
- $V_{REF(ML)} = (STEP_V_{ref_margin_low} + V_{ref_trim}) \times 2^{-9}$
- Assume $V_{ref_Trim} = -3$ here (from V_{ref_Trim} example earlier)
- $STEP_V_{ref_margin_low} = V_{REF(ML)} \times 512 - V_{ref_trim}$
- $STEP_V_{ref_margin_low} = -0.033 \times 512 - (-3) = -16.9 + 3 = -13.9 = -14$ (rounded to nearest integer)

The module shall support the margined high or low voltages using the OPERATION command. Bits [5:2] shall be used to enable margining as follows:

00XX	: Margin Off
0101	: Margin Low (Act on Fault)
0110	: Margin Low (Act on Fault)
1001	: Margin High (Act on Fault)
1010	: Margin High (Act on Fault)

PMBus Adjustable Overcurrent Warning

The module can provide an overcurrent warning via the PMBus. The threshold for the overcurrent warning can be set using the parameter $I_{OUT_OC_WARN_LIMIT}$. This command uses the “Linear” data format with a two byte data word where the upper five bits [7:3] of the high byte represent the exponent and the remaining three bits of the

2 × 6A Digital Dual MicroDlynx™: Non-Isolated DC-DC Power Modules

4.5Vdc –14.4Vdc input; 0.51Vdc to 5.5Vdc output; 2 × 6A Output Current

high byte [2:0] and the eight bits in the low byte represent the mantissa. The exponent is fixed at -1 (decimal). The upper five bits of the mantissa are fixed at 0 while the lower six bits are programmable with a default value of 19A (decimal). The resolution of this warning limit is 500mA. The value of the IOUT_OC_WARN_LIMIT can be stored to non-volatile memory using the STORE_DEFAULT_ALL command.

Temperature Status via PMBus

The module will provide information related to temperature of the module through the READ_TEMPERATURE_2 command. The command returns external temperature in degrees Celsius. This command shall use the “Linear” data format with a two byte data word where the upper five bits [7:3] of the high byte shall represent the exponent and the remaining three bits of the high byte [2:0] and the eight bits in the low byte shall represent the mantissa. The exponent is fixed at 0 (decimal). The lower 11 bits are the result of the ADC conversion of the external temperature

PMBus Adjustable Output Over, Under Voltage Protection and Power Good

The module has a common command to set the PGOOD, VOUT_UNDER_VOLTAGE(UV) and VOUT_OVER_VOLTAGE(OV) limits as a percentage of nominal. Refer to Table 6 of the next section for the available settings. The PMBus command VOUT_OVER_VOLTAGE(OV) shall be used to set the output over voltage threshold from two possible values: +12.5% or +16.67% of the commanded output voltage for each output.

The module provides a Power Good (PGOOD) for each output signal that shall be implemented with an open-drain output to indicate that the output voltage is within the regulation limits of the power module. The PGOOD signal shall be de-asserted to a low state if any condition such as overtemperature, overcurrent or loss of regulation occurs that would result in the output voltage going outside the specified thresholds. The PGOOD thresholds shall be user selectable via the PMBus (the default values are as shown in the Feature Specifications Section). Each threshold shall be set up symmetrically above and below the nominal value. The PGL (POWERGOODLOW) command shall set the output voltage level above which PGOOD is asserted (lower threshold). The PGH(POWERGOODHIGH) command shall set the level above which the PGOOD command is de-asserted. This command shall also set two thresholds symmetrically placed around the nominal output voltage. Normally, the PGL threshold shall be set higher than the PGH threshold.

The PGOOD terminal can be connected through a pullup resistor (suggested value 100KΩ) to a source of 5VDC or lower. The current through the PGood terminal should be limited to a max value of 5mA

PMBus Adjustable Input Undervoltage Lockout

The module allows for adjustment of the input under voltage lockout and hysteresis. The command VIN_ON allows setting the input voltage turn on threshold for each output, while the VIN_OFF command shall set the input voltage turn off threshold. For the VIN_ON command, possible values are 4.25V to 16V in variable steps. For the VIN_OFF command, possible values are 4V to 15.75V in 0.5V steps. If other values

are entered for either command, they shall be mapped to the closest of the allowed values.

Both the VIN_ON and VIN_OFF commands use the “Linear” format with two data bytes. The upper five bits shall represent the exponent (fixed at -2) and the remaining 11 bits shall represent the mantissa. For the mantissa, the four most significant bits are fixed at 0.

Measurement of Output Current, Output Voltage and Input Voltage

The module is capable of measuring key module parameters such as output current and voltage for each outputs and input voltage for each input and providing this information through the PMBus interface.

Measuring Output Current Using the PMBus

The module measures current by using the inductor winding resistance as a current sense element. The inductor winding resistance is then the current gain factor used to scale the measured voltage into a current reading. This gain factor is the argument of the IOUT_CAL_GAIN command, and consists of two bytes in the linear data format. The exponent uses the upper five bits [7:3] of the high data byte in two's complement format and is fixed at -15 (decimal). The remaining 11 bits in two's complement binary format represent the mantissa. During manufacture, each module is calibrated by measuring and storing the current gain factor into non-volatile storage.

The current measurement accuracy is also improved by each module being calibrated during manufacture with the offset in the current reading. The IOUT_CAL_OFFSET command is used to store and read the current offset. The argument for this command consists of two bytes composed of a 5-bit exponent (fixed at -4d) and a 11-bit mantissa. This command has a resolution of 62.5mA and a range of -4000mA to +3937.5mA.

The READ_IOUT command provides module average output current information. This command only supports positive or current sourced from the module. If the converter is sinking current a reading of 0 is provided. The READ_IOUT command returns two bytes of data in the linear data format. The exponent uses the upper five bits [7:3] of the high data byte in two's complement format and is fixed at -4 (decimal). The remaining 11 bits in two's complement binary format represent the mantissa with the 11th bit fixed at 0 since only positive numbers are considered valid.

Measuring Output Voltage Using the PMBus

The module provides output voltage information using the READ_VOUT command for each output. In this module the output voltage is sensed at the remote sense amplifier output pin so voltage drop to the load is not accounted for. The command shall return two bytes of data all representing the mantissa while the exponent is fixed at -9 (decimal).

Reading the Status of the Module using the PMBus

The module supports a number of status information commands implemented in PMBus. However, not all

2 × 6A Digital Dual MicroDlynx™: Non-Isolated DC-DC Power Modules

4.5Vdc –14.4Vdc input; 0.51Vdc to 5.5Vdc output; 2 × 6A Output Current

features are supported in these commands. A 1 in the bit position indicates the fault that is flagged.

STATUS_BYTE : Returns one byte of information with a summary of the most critical device faults.

Bit Position	Flag	Default Value
7	X	0
6	OFF	0
5	VOUT Overvoltage	0
4	IOUT Overcurrent	0
3	VIN Undervoltage	0
2	Temperature	0
1	CML (Comm. Memory Fault)	0
0	None of the above	0

STATUS_WORD : Returns two bytes of information with a summary of the module's fault/warning conditions.

Low Byte

Bit Position	Flag	Default Value
7	X	0
6	OFF	0
5	VOUT Overvoltage	0
4	IOUT Overcurrent	0
3	VIN Undervoltage	0
2	Temperature	0
1	CML (Comm. Memory Fault)	0
0	None of the above	0

High Byte

Bit Position	Flag	Default Value
7	VOUT fault or warning	0
6	IOUT fault or warning	0
5	X	0
4	MFR	0
3	POWER_GOOD# (is negated)	0
2	X	0
1	X	0
0	X	0

STATUS_VOUT : Returns one byte of information relating to the status of the module's output voltage related faults.

Bit Position	Flag	Default Value
7	VOUT OV Fault	0
6	X	0
5	X	0
4	VOUT UV Fault	0
3	X	0
2	X	0
1	X	0
0	X	0

STATUS_IOUT : Returns one byte of information relating to the status of the module's output voltage related faults.

Bit Position	Flag	Default Value
7	X	0
6	OFF	0
5	VOUT Overvoltage	0
4	IOUT Overcurrent	0
3	VIN Undervoltage	0
2	Temperature	0
1	CML (Comm. Memory Fault)	0
0	None of the above	0

7	IOUT OC Fault	0
6	X	0
5	IOUT OC Warning	0
4	X	0
3	X	0
2	X	0
1	X	0
0	X	0

STATUS_TEMPERATURE : Returns one byte of information relating to the status of the module's temperature related faults.

Bit Position	Flag	Default Value
7	OT Fault	0
6	OT Warning	0
5	X	0
4	X	0
3	X	0
2	X	0
1	X	0
0	X	0

STATUS_CML : Returns one byte of information relating to the status of the module's communication related faults.

Bit Position	Flag	Default Value
7	Invalid/Unsupported Command	0
6	Invalid/Unsupported Command	0
5	Packet Error Check Failed	0
4	Memory Fault Detected	0
3	X	0
2	X	0
1	Other Communication Fault	0
0	X	0

MFR_VIN_MIN : Returns minimum input voltage as two data bytes of information in Linear format (upper five bits are exponent – fixed at -2, and lower 11 bits are mantissa in two's complement format – fixed at 12)

MFR_VOUT_MIN : Returns minimum output voltage as two data bytes of information in Linear format (upper five bits are exponent – fixed at -10, and lower 11 bits are mantissa in two's complement format – fixed at 614)

MFR_SPECIFIC_00 : Returns information related to the type of module and revision number. Bits [7:2] in the Low Byte indicate the module type (001001 corresponds to the UDXS0606 series of module), while bits [7:3] indicate the revision number of the module.

Low Byte

Bit Position	Flag	Default Value
7:2	Module Name	001001
1:0	Reserved	10

High Byte

Bit Position	Flag	Default Value
7	X	0
6	OFF	0
5	VOUT Overvoltage	0
4	IOUT Overcurrent	0
3	VIN Undervoltage	0
2	Temperature	0
1	CML (Comm. Memory Fault)	0
0	None of the above	0

2 × 6A Digital Dual MicroDlynx™: Non-Isolated DC-DC Power Modules

4.5Vdc –14.4Vdc input; 0.51Vdc to 5.5Vdc output; 2 × 6A Output Current

7:3	Module Revision Number	None
2:0	Reserved	000

2 × 6A Digital Dual MicroDlynx™: Non-Isolated DC-DC Power Modules

4.5Vdc –14.4Vdc input; 0.51Vdc to 5.5Vdc output; 2 × 6A Output Current

Summary of Supported PMBus Commands

Please refer to the PMBus 1.1 specification for more details of these commands.

Table 6

Hex Code	Command	Brief Description	Non-Volatile Memory Storage																																																												
00	PAGE	<p>Ability to configure, control and monitor each output by using only one physical address of the module</p> <table border="1"> <thead> <tr> <th>Format</th> <th colspan="8">Unsigned Binary</th> </tr> </thead> <tbody> <tr> <td>Bit Position</td> <td>7</td> <td>6</td> <td>5</td> <td>4</td> <td>3</td> <td>2</td> <td>1</td> <td>0</td> </tr> <tr> <td>Access</td> <td>r/w</td> <td>r</td> <td>r</td> <td>r</td> <td>r</td> <td>r</td> <td>r</td> <td>r/w</td> </tr> <tr> <td>Function</td> <td>PA</td> <td>X</td> <td>X</td> <td>X</td> <td>X</td> <td>X</td> <td>X</td> <td>P0</td> </tr> <tr> <td>Default Value</td> <td>0</td> <td>X</td> <td>X</td> <td>X</td> <td>X</td> <td>X</td> <td>X</td> <td>0</td> </tr> </tbody> </table> <p>PAGE Command Truth Table</p> <table border="1"> <thead> <tr> <th>PA</th> <th>P0</th> <th>Logic Results</th> </tr> </thead> <tbody> <tr> <td>0</td> <td>0</td> <td>All Commands address first output</td> </tr> <tr> <td>0</td> <td>1</td> <td>All Commands address second output</td> </tr> <tr> <td>1</td> <td>0</td> <td>Illegal input, Ignore write</td> </tr> <tr> <td>1</td> <td>1</td> <td>All Commands address both outputs</td> </tr> </tbody> </table>	Format	Unsigned Binary								Bit Position	7	6	5	4	3	2	1	0	Access	r/w	r	r	r	r	r	r	r/w	Function	PA	X	X	X	X	X	X	P0	Default Value	0	X	X	X	X	X	X	0	PA	P0	Logic Results	0	0	All Commands address first output	0	1	All Commands address second output	1	0	Illegal input, Ignore write	1	1	All Commands address both outputs	
Format	Unsigned Binary																																																														
Bit Position	7	6	5	4	3	2	1	0																																																							
Access	r/w	r	r	r	r	r	r	r/w																																																							
Function	PA	X	X	X	X	X	X	P0																																																							
Default Value	0	X	X	X	X	X	X	0																																																							
PA	P0	Logic Results																																																													
0	0	All Commands address first output																																																													
0	1	All Commands address second output																																																													
1	0	Illegal input, Ignore write																																																													
1	1	All Commands address both outputs																																																													
01	OPERATION	<p>Turn Module on or off. Also used to margin the output voltage</p> <table border="1"> <thead> <tr> <th>Format</th> <th colspan="8">Unsigned Binary</th> </tr> </thead> <tbody> <tr> <td>Bit Position</td> <td>7</td> <td>6</td> <td>5</td> <td>4</td> <td>3</td> <td>2</td> <td>1</td> <td>0</td> </tr> <tr> <td>Access</td> <td>r/w</td> <td>r</td> <td>r/w</td> <td>r/w</td> <td>r/w</td> <td>r/w</td> <td>r</td> <td>r</td> </tr> <tr> <td>Function</td> <td>On</td> <td>X</td> <td colspan="4">Margin</td> <td>X</td> <td>X</td> <td></td> </tr> <tr> <td>Default Value</td> <td>0</td> <td>0</td> <td>0</td> <td>0</td> <td>0</td> <td>0</td> <td>X</td> <td>X</td> </tr> </tbody> </table> <p>Bit 7: 0 Output switching disabled 1 Output switching enabled Margin: 00XX Margin Off 0101 Margin Low (Act on fault) 0110 Margin Low (Act on fault) 1001 Margin High (Act on fault) 1010 Margin High (Act on fault)</p>	Format	Unsigned Binary								Bit Position	7	6	5	4	3	2	1	0	Access	r/w	r	r/w	r/w	r/w	r/w	r	r	Function	On	X	Margin				X	X		Default Value	0	0	0	0	0	0	X	X															
Format	Unsigned Binary																																																														
Bit Position	7	6	5	4	3	2	1	0																																																							
Access	r/w	r	r/w	r/w	r/w	r/w	r	r																																																							
Function	On	X	Margin				X	X																																																							
Default Value	0	0	0	0	0	0	X	X																																																							
02	ON_OFF_CONFIG	<p>Configures the ON/OFF functionality as a combination of analog ON/OFF pin and PMBus commands</p> <table border="1"> <thead> <tr> <th>Format</th> <th colspan="8">Unsigned Binary</th> </tr> </thead> <tbody> <tr> <td>Bit Position</td> <td>7</td> <td>6</td> <td>5</td> <td>4</td> <td>3</td> <td>2</td> <td>1</td> <td>0</td> </tr> <tr> <td>Access</td> <td>r</td> <td>r</td> <td>r</td> <td>r/w</td> <td>r/w</td> <td>r/w</td> <td>r/w</td> <td>r</td> </tr> <tr> <td>Function</td> <td>X</td> <td>X</td> <td>X</td> <td>pu</td> <td>cmd</td> <td>cpr</td> <td>pol</td> <td>cpa</td> </tr> <tr> <td>Default Value</td> <td>0</td> <td>0</td> <td>0</td> <td>1</td> <td>0</td> <td>1</td> <td>1</td> <td>0</td> </tr> </tbody> </table> <p>Refer to Page 19 for details on pu, cmd, cpr, pol and cpa</p>	Format	Unsigned Binary								Bit Position	7	6	5	4	3	2	1	0	Access	r	r	r	r/w	r/w	r/w	r/w	r	Function	X	X	X	pu	cmd	cpr	pol	cpa	Default Value	0	0	0	1	0	1	1	0	YES															
Format	Unsigned Binary																																																														
Bit Position	7	6	5	4	3	2	1	0																																																							
Access	r	r	r	r/w	r/w	r/w	r/w	r																																																							
Function	X	X	X	pu	cmd	cpr	pol	cpa																																																							
Default Value	0	0	0	1	0	1	1	0																																																							
03	CLEAR_FAULTS	<p>Clear any fault bits that may have been set, also releases the SMBALERT# signal if the device has been asserting it.</p>																																																													
10	WRITE_PROTECT	<p>Used to control writing to the module via PMBus. Copies the current register setting in the module whose command code matches the value in the data byte into non-volatile memory (EEPROM) on the module</p> <table border="1"> <thead> <tr> <th>Format</th> <th colspan="8">Unsigned Binary</th> </tr> </thead> <tbody> <tr> <td>Bit Position</td> <td>7</td> <td>6</td> <td>5</td> <td>4</td> <td>3</td> <td>2</td> <td>1</td> <td>0</td> </tr> <tr> <td>Access</td> <td>r/w</td> <td>r/w</td> <td>r/w</td> <td>x</td> <td>x</td> <td>x</td> <td>x</td> <td>x</td> </tr> <tr> <td>Function</td> <td>bit7</td> <td>bit6</td> <td>bit5</td> <td>X</td> <td>X</td> <td>X</td> <td>X</td> <td>X</td> </tr> <tr> <td>Default Value</td> <td>0</td> <td>0</td> <td>0</td> <td>X</td> <td>X</td> <td>X</td> <td>X</td> <td>X</td> </tr> </tbody> </table> <p>Bit5: 0 – Enables all writes as permitted in bit6 or bit7 1 – Disables all writes except the WRITE_PROTECT, PAGE OPERATION and ON_OFF_CONFIG (bit 6 and bit7 must be 0) Bit 6: 0 – Enables all writes as permitted in bit5 or bit7 1 – Disables all writes except for the WRITE_PROTECT, PAGE and OPERATION commands (bit5 and bit7 must be 0) Bit7: 0 – Enables all writes as permitted in bit5 or bit6 1 – Disables all writes except for the WRITE_PROTECT command (bit5 and bit6 must be 0)</p>	Format	Unsigned Binary								Bit Position	7	6	5	4	3	2	1	0	Access	r/w	r/w	r/w	x	x	x	x	x	Function	bit7	bit6	bit5	X	X	X	X	X	Default Value	0	0	0	X	X	X	X	X	YES															
Format	Unsigned Binary																																																														
Bit Position	7	6	5	4	3	2	1	0																																																							
Access	r/w	r/w	r/w	x	x	x	x	x																																																							
Function	bit7	bit6	bit5	X	X	X	X	X																																																							
Default Value	0	0	0	X	X	X	X	X																																																							
15	STORE_USER_ALL	<p>Stores all of the current storable register settings in the EEPROM memory as the new defaults on power up</p>																																																													

2 × 6A Digital Dual MicroDlynx™: Non-Isolated DC-DC Power Modules
 4.5Vdc –14.4Vdc input; 0.51Vdc to 5.5Vdc output; 2 × 6A Output Current

Hex Code	Command	Brief Description	Non-Volatile Memory Storage																																																																																	
16	RESTORE_USER_ALL	Restores all of the storable register settings from the non-volatile memory (EEPROM). The command should not be used while the device is actively switching																																																																																		
19	CAPABILITY	<p>This command helps the host system/GUI/CLI determine key capabilities of the module</p> <table border="1"> <thead> <tr> <th>Format</th> <th colspan="8">Unsigned Binary</th> </tr> </thead> <tbody> <tr> <td>Bit Position</td> <td>7</td> <td>6</td> <td>5</td> <td>4</td> <td>3</td> <td>2</td> <td>1</td> <td>0</td> </tr> <tr> <td>Access</td> <td>r</td> <td>r</td> <td>r</td> <td>r</td> <td>r</td> <td>r</td> <td>r</td> <td>r</td> </tr> <tr> <td>Function</td> <td>PEC</td> <td colspan="2">SPD</td> <td>ALRT</td> <td colspan="4">Reserved</td> </tr> <tr> <td>Default Value</td> <td>1</td> <td>0</td> <td>1</td> <td>1</td> <td>0</td> <td>0</td> <td>0</td> <td>0</td> </tr> </tbody> </table> <p>PEC - 1 Supported SPD -01 - max of 400kHz ALRT - 1 - SMBALERT# supported</p>	Format	Unsigned Binary								Bit Position	7	6	5	4	3	2	1	0	Access	r	r	r	r	r	r	r	r	Function	PEC	SPD		ALRT	Reserved				Default Value	1	0	1	1	0	0	0	0																																					
Format	Unsigned Binary																																																																																			
Bit Position	7	6	5	4	3	2	1	0																																																																												
Access	r	r	r	r	r	r	r	r																																																																												
Function	PEC	SPD		ALRT	Reserved																																																																															
Default Value	1	0	1	1	0	0	0	0																																																																												
20	VOUT_MODE	<p>The module has MODE set to Linear and Exponent set to -10. These values cannot be changed</p> <table border="1"> <thead> <tr> <th>Bit Position</th> <td>7</td> <td>6</td> <td>5</td> <td>4</td> <td>3</td> <td>2</td> <td>1</td> <td>0</td> </tr> </thead> <tbody> <tr> <td>Access</td> <td>r</td> <td>r</td> <td>r</td> <td>r</td> <td>r</td> <td>r</td> <td>r</td> <td>r</td> </tr> <tr> <td>Function</td> <td colspan="4">Mode</td> <td colspan="4">Exponent</td> </tr> <tr> <td>Default Value</td> <td>0</td> <td>0</td> <td>0</td> <td>1</td> <td>0</td> <td>1</td> <td>1</td> <td>1</td> </tr> </tbody> </table> <p>Mode: Value fixed at 000, linear mode Exponent: Value fixed at 10111, Exponent for linear mode values is -9</p>	Bit Position	7	6	5	4	3	2	1	0	Access	r	r	r	r	r	r	r	r	Function	Mode				Exponent				Default Value	0	0	0	1	0	1	1	1																																														
Bit Position	7	6	5	4	3	2	1	0																																																																												
Access	r	r	r	r	r	r	r	r																																																																												
Function	Mode				Exponent																																																																															
Default Value	0	0	0	1	0	1	1	1																																																																												
35	VIN_ON	<p>Sets the value of input voltage at which the module turns on</p> <table border="1"> <thead> <tr> <th>Format</th> <th colspan="8">Linear, two's complement binary</th> </tr> </thead> <tbody> <tr> <td>Bit Position</td> <td>7</td> <td>6</td> <td>5</td> <td>4</td> <td>3</td> <td>2</td> <td>1</td> <td>0</td> </tr> <tr> <td>Access</td> <td>r</td> <td>r</td> <td>r</td> <td>r</td> <td>r</td> <td>r</td> <td>r</td> <td>r</td> </tr> <tr> <td>Function</td> <td colspan="4">Exponent</td> <td colspan="4">Mantissa</td> </tr> <tr> <td>Default Value</td> <td>1</td> <td>1</td> <td>1</td> <td>1</td> <td>0</td> <td>0</td> <td>0</td> <td>0</td> </tr> <tr> <td>Bit Position</td> <td>7</td> <td>6</td> <td>5</td> <td>4</td> <td>3</td> <td>2</td> <td>1</td> <td>0</td> </tr> <tr> <td>Access</td> <td>r</td> <td>r/w</td> <td>r/w</td> <td>r/w</td> <td>r/w</td> <td>r/w</td> <td>r/w</td> <td>r/w</td> </tr> <tr> <td>Function</td> <td colspan="8">Mantissa</td> </tr> <tr> <td>Default Value</td> <td>0</td> <td>0</td> <td>0</td> <td>1</td> <td>0</td> <td>0</td> <td>0</td> <td>1</td> </tr> </tbody> </table> <p>Exponent -2 (dec), fixed Mantissa The upper four bits are fixed at 0 The lower seven are programmable with a default value of 9(dec). This corresponds to a default of 4.25V. Allowable values are</p> <ul style="list-style-type: none"> • 4.25, in steps of 0.25V upto 9.5V. • 9.5V to 13V in increments of 0.5V • 13V to 16V in increments of 1V 	Format	Linear, two's complement binary								Bit Position	7	6	5	4	3	2	1	0	Access	r	r	r	r	r	r	r	r	Function	Exponent				Mantissa				Default Value	1	1	1	1	0	0	0	0	Bit Position	7	6	5	4	3	2	1	0	Access	r	r/w	r/w	r/w	r/w	r/w	r/w	r/w	Function	Mantissa								Default Value	0	0	0	1	0	0	0	1	YES
Format	Linear, two's complement binary																																																																																			
Bit Position	7	6	5	4	3	2	1	0																																																																												
Access	r	r	r	r	r	r	r	r																																																																												
Function	Exponent				Mantissa																																																																															
Default Value	1	1	1	1	0	0	0	0																																																																												
Bit Position	7	6	5	4	3	2	1	0																																																																												
Access	r	r/w	r/w	r/w	r/w	r/w	r/w	r/w																																																																												
Function	Mantissa																																																																																			
Default Value	0	0	0	1	0	0	0	1																																																																												
36	VIN_OFF	<p>Sets the value of input voltage at which the module turns off</p> <table border="1"> <thead> <tr> <th>Format</th> <th colspan="8">Linear, two's complement binary</th> </tr> </thead> <tbody> <tr> <td>Bit Position</td> <td>7</td> <td>6</td> <td>5</td> <td>4</td> <td>3</td> <td>2</td> <td>1</td> <td>0</td> </tr> <tr> <td>Access</td> <td>r</td> <td>r</td> <td>r</td> <td>r</td> <td>r</td> <td>r</td> <td>r</td> <td>r</td> </tr> <tr> <td>Function</td> <td colspan="4">Exponent</td> <td colspan="4">Mantissa</td> </tr> <tr> <td>Default Value</td> <td>1</td> <td>1</td> <td>1</td> <td>1</td> <td>0</td> <td>0</td> <td>0</td> <td>0</td> </tr> <tr> <td>Bit Position</td> <td>7</td> <td>6</td> <td>5</td> <td>4</td> <td>3</td> <td>2</td> <td>1</td> <td>0</td> </tr> <tr> <td>Access</td> <td>r</td> <td>r/w</td> <td>r/w</td> <td>r/w</td> <td>r/w</td> <td>r/w</td> <td>r/w</td> <td>r/w</td> </tr> <tr> <td>Function</td> <td colspan="8">Mantissa</td> </tr> <tr> <td>Default Value</td> <td>0</td> <td>0</td> <td>0</td> <td>0</td> <td>1</td> <td>0</td> <td>0</td> <td>0</td> </tr> </tbody> </table> <p>Exponent -2 (dec), fixed Mantissa The upper four bits are fixed at 0 The lower seven are programmable with a default value of 8(dec). This corresponds to a default of 4.0V. Allowable values are</p> <ul style="list-style-type: none"> • 4.00, in steps of 0.25V upto 9.75V. • 10.25V to 11.75V in increments of 0.5V • 12V • 13.75V to 16.75V in increments of 1V 	Format	Linear, two's complement binary								Bit Position	7	6	5	4	3	2	1	0	Access	r	r	r	r	r	r	r	r	Function	Exponent				Mantissa				Default Value	1	1	1	1	0	0	0	0	Bit Position	7	6	5	4	3	2	1	0	Access	r	r/w	r/w	r/w	r/w	r/w	r/w	r/w	Function	Mantissa								Default Value	0	0	0	0	1	0	0	0	YES
Format	Linear, two's complement binary																																																																																			
Bit Position	7	6	5	4	3	2	1	0																																																																												
Access	r	r	r	r	r	r	r	r																																																																												
Function	Exponent				Mantissa																																																																															
Default Value	1	1	1	1	0	0	0	0																																																																												
Bit Position	7	6	5	4	3	2	1	0																																																																												
Access	r	r/w	r/w	r/w	r/w	r/w	r/w	r/w																																																																												
Function	Mantissa																																																																																			
Default Value	0	0	0	0	1	0	0	0																																																																												

2 × 6A Digital Dual MicroDlynx™: Non-Isolated DC-DC Power Modules
 4.5Vdc –14.4Vdc input; 0.51Vdc to 5.5Vdc output; 2 × 6A Output Current

Hex Code	Command	Brief Description	Non-Volatile Memory Storage																																																																																	
38	IOUT_CAL_GAIN	Returns the value of the gain correction term used to correct the measured output current <table border="1"> <tr> <th>Format</th> <td colspan="8">Linear, two's complement binary</td> </tr> <tr> <th>Bit Position</th> <td>7</td><td>6</td><td>5</td><td>4</td><td>3</td><td>2</td><td>1</td><td>0</td> </tr> <tr> <th>Access</th> <td>r</td><td>r</td><td>r</td><td>r</td><td>r</td><td>r</td><td>r</td><td>r/w</td> </tr> <tr> <th>Function</th> <td colspan="4">Exponent</td> <td colspan="4">Mantissa</td> </tr> <tr> <th>Default Value</th> <td>1</td><td>0</td><td>0</td><td>0</td><td>1</td><td>0</td><td>0</td><td>V</td> </tr> <tr> <th>Bit Position</th> <td>7</td><td>6</td><td>5</td><td>4</td><td>3</td><td>2</td><td>1</td><td>0</td> </tr> <tr> <th>Access</th> <td>r/w</td><td>r/w</td><td>r/w</td><td>r/w</td><td>r/w</td><td>r/w</td><td>r/w</td><td>r/w</td> </tr> <tr> <th>Function</th> <td colspan="8">Mantissa</td> </tr> <tr> <th>Default Value</th> <td colspan="8">V: Variable based on factory calibration</td> </tr> </table>	Format	Linear, two's complement binary								Bit Position	7	6	5	4	3	2	1	0	Access	r	r	r	r	r	r	r	r/w	Function	Exponent				Mantissa				Default Value	1	0	0	0	1	0	0	V	Bit Position	7	6	5	4	3	2	1	0	Access	r/w	r/w	r/w	r/w	r/w	r/w	r/w	r/w	Function	Mantissa								Default Value	V: Variable based on factory calibration								YES
Format	Linear, two's complement binary																																																																																			
Bit Position	7	6	5	4	3	2	1	0																																																																												
Access	r	r	r	r	r	r	r	r/w																																																																												
Function	Exponent				Mantissa																																																																															
Default Value	1	0	0	0	1	0	0	V																																																																												
Bit Position	7	6	5	4	3	2	1	0																																																																												
Access	r/w	r/w	r/w	r/w	r/w	r/w	r/w	r/w																																																																												
Function	Mantissa																																																																																			
Default Value	V: Variable based on factory calibration																																																																																			
39	IOUT_CAL_OFFSET	Returns the value of the offset correction used to correct the measured output current <table border="1"> <tr> <th>Format</th> <td colspan="8">Linear, two's complement binary</td> </tr> <tr> <th>Bit Position</th> <td>7</td><td>6</td><td>5</td><td>4</td><td>3</td><td>2</td><td>1</td><td>0</td> </tr> <tr> <th>Access</th> <td>r</td><td>r</td><td>r</td><td>r</td><td>r</td><td>r/w</td><td>r</td><td>r</td> </tr> <tr> <th>Function</th> <td colspan="4">Exponent</td> <td colspan="4">Mantissa</td> </tr> <tr> <th>Default Value</th> <td>1</td><td>1</td><td>1</td><td>0</td><td>0</td><td>V</td><td>V</td><td>V</td> </tr> <tr> <th>Bit Position</th> <td>7</td><td>6</td><td>5</td><td>4</td><td>3</td><td>2</td><td>1</td><td>0</td> </tr> <tr> <th>Access</th> <td>r</td><td>r</td><td>r/w</td><td>r/w</td><td>r/w</td><td>r/w</td><td>r/w</td><td>r/w</td> </tr> <tr> <th>Function</th> <td colspan="8">Mantissa</td> </tr> <tr> <th>Default Value</th> <td colspan="8">V: Variable based on factory calibration</td> </tr> </table>	Format	Linear, two's complement binary								Bit Position	7	6	5	4	3	2	1	0	Access	r	r	r	r	r	r/w	r	r	Function	Exponent				Mantissa				Default Value	1	1	1	0	0	V	V	V	Bit Position	7	6	5	4	3	2	1	0	Access	r	r	r/w	r/w	r/w	r/w	r/w	r/w	Function	Mantissa								Default Value	V: Variable based on factory calibration								YES
Format	Linear, two's complement binary																																																																																			
Bit Position	7	6	5	4	3	2	1	0																																																																												
Access	r	r	r	r	r	r/w	r	r																																																																												
Function	Exponent				Mantissa																																																																															
Default Value	1	1	1	0	0	V	V	V																																																																												
Bit Position	7	6	5	4	3	2	1	0																																																																												
Access	r	r	r/w	r/w	r/w	r/w	r/w	r/w																																																																												
Function	Mantissa																																																																																			
Default Value	V: Variable based on factory calibration																																																																																			
46	IOUT_OC_FAULT_LIMIT	Sets the output overcurrent fault level in A (cannot be changed) <table border="1"> <tr> <th>Format</th> <td colspan="8">Linear, two's complement binary</td> </tr> <tr> <th>Bit Position</th> <td>7</td><td>6</td><td>5</td><td>4</td><td>3</td><td>2</td><td>1</td><td>0</td> </tr> <tr> <th>Access</th> <td>r</td><td>r</td><td>r</td><td>r</td><td>r</td><td>r</td><td>r</td><td>r</td> </tr> <tr> <th>Function</th> <td colspan="4">Exponent</td> <td colspan="4">Mantissa</td> </tr> <tr> <th>Default Value</th> <td>1</td><td>1</td><td>1</td><td>1</td><td>1</td><td>0</td><td>0</td><td>0</td> </tr> <tr> <th>Bit Position</th> <td>7</td><td>6</td><td>5</td><td>4</td><td>3</td><td>2</td><td>1</td><td>0</td> </tr> <tr> <th>Access</th> <td>r</td><td>r/w</td><td>r/w</td><td>r/w</td><td>r/w</td><td>r/w</td><td>r/w</td><td>r/w</td> </tr> <tr> <th>Function</th> <td colspan="8">Mantissa</td> </tr> <tr> <th>Default Value</th> <td>0</td><td>0</td><td>1</td><td>0</td><td>1</td><td>0</td><td>0</td><td>0</td> </tr> </table> Value maybe locked	Format	Linear, two's complement binary								Bit Position	7	6	5	4	3	2	1	0	Access	r	r	r	r	r	r	r	r	Function	Exponent				Mantissa				Default Value	1	1	1	1	1	0	0	0	Bit Position	7	6	5	4	3	2	1	0	Access	r	r/w	r/w	r/w	r/w	r/w	r/w	r/w	Function	Mantissa								Default Value	0	0	1	0	1	0	0	0	YES
Format	Linear, two's complement binary																																																																																			
Bit Position	7	6	5	4	3	2	1	0																																																																												
Access	r	r	r	r	r	r	r	r																																																																												
Function	Exponent				Mantissa																																																																															
Default Value	1	1	1	1	1	0	0	0																																																																												
Bit Position	7	6	5	4	3	2	1	0																																																																												
Access	r	r/w	r/w	r/w	r/w	r/w	r/w	r/w																																																																												
Function	Mantissa																																																																																			
Default Value	0	0	1	0	1	0	0	0																																																																												
47	IOUT_OC_FAULT_RESPONSE	Determines module action in response to an IOUT_OC_FAULT_LIMIT or a VOUT undervoltage (UV) fault <table border="1"> <tr> <th>Format</th> <td colspan="8">Unsigned Binary</td> </tr> <tr> <th>Bit Position</th> <td>7</td><td>6</td><td>5</td><td>4</td><td>3</td><td>2</td><td>1</td><td>0</td> </tr> <tr> <th>Access</th> <td>r</td><td>r</td><td>r/w</td><td>r/w</td><td>r/w</td><td>r</td><td>r</td><td>r</td> </tr> <tr> <th>Function</th> <td>X</td><td>X</td><td>RS [2]</td><td>RS [1]</td><td>RS [0]</td><td>x</td><td>X</td><td>X</td> </tr> <tr> <th>Default Value</th> <td>0</td><td>0</td><td>1</td><td>1</td><td>1</td><td>1</td><td>0</td><td>0</td> </tr> </table> RS[2:0] – Retry Setting 000 Unit does not attempt to restart 111 Unit goes through normal soft start continuously Any other value is not acceptable	Format	Unsigned Binary								Bit Position	7	6	5	4	3	2	1	0	Access	r	r	r/w	r/w	r/w	r	r	r	Function	X	X	RS [2]	RS [1]	RS [0]	x	X	X	Default Value	0	0	1	1	1	1	0	0	YES																																				
Format	Unsigned Binary																																																																																			
Bit Position	7	6	5	4	3	2	1	0																																																																												
Access	r	r	r/w	r/w	r/w	r	r	r																																																																												
Function	X	X	RS [2]	RS [1]	RS [0]	x	X	X																																																																												
Default Value	0	0	1	1	1	1	0	0																																																																												
4A	IOUT_OC_WARN_LIMIT	Sets the output overcurrent warning level in A <table border="1"> <tr> <th>Format</th> <td colspan="8">Linear, two's complement binary</td> </tr> <tr> <th>Bit Position</th> <td>7</td><td>6</td><td>5</td><td>4</td><td>3</td><td>2</td><td>1</td><td>0</td> </tr> <tr> <th>Access</th> <td>r</td><td>r</td><td>r</td><td>r</td><td>r</td><td>r</td><td>r</td><td>r</td> </tr> <tr> <th>Function</th> <td colspan="4">Exponent</td> <td colspan="4">Mantissa</td> </tr> <tr> <th>Default Value</th> <td>1</td><td>1</td><td>1</td><td>1</td><td>1</td><td>0</td><td>0</td><td>0</td> </tr> <tr> <th>Bit Position</th> <td>7</td><td>6</td><td>5</td><td>4</td><td>3</td><td>2</td><td>1</td><td>0</td> </tr> <tr> <th>Access</th> <td>r</td><td>r/w</td><td>r/w</td><td>r/w</td><td>r/w</td><td>r/w</td><td>r/w</td><td>r/w</td> </tr> <tr> <th>Function</th> <td colspan="8">Mantissa</td> </tr> <tr> <th>Default Value</th> <td>0</td><td>0</td><td>1</td><td>0</td><td>0</td><td>1</td><td>1</td><td>0</td> </tr> </table> Value may be locked	Format	Linear, two's complement binary								Bit Position	7	6	5	4	3	2	1	0	Access	r	r	r	r	r	r	r	r	Function	Exponent				Mantissa				Default Value	1	1	1	1	1	0	0	0	Bit Position	7	6	5	4	3	2	1	0	Access	r	r/w	r/w	r/w	r/w	r/w	r/w	r/w	Function	Mantissa								Default Value	0	0	1	0	0	1	1	0	
Format	Linear, two's complement binary																																																																																			
Bit Position	7	6	5	4	3	2	1	0																																																																												
Access	r	r	r	r	r	r	r	r																																																																												
Function	Exponent				Mantissa																																																																															
Default Value	1	1	1	1	1	0	0	0																																																																												
Bit Position	7	6	5	4	3	2	1	0																																																																												
Access	r	r/w	r/w	r/w	r/w	r/w	r/w	r/w																																																																												
Function	Mantissa																																																																																			
Default Value	0	0	1	0	0	1	1	0																																																																												

2 × 6A Digital Dual MicroDlynx™: Non-Isolated DC-DC Power Modules
 4.5Vdc –14.4Vdc input; 0.51Vdc to 5.5Vdc output; 2 × 6A Output Current

Hex Code	Command	Brief Description	Non-Volatile Memory Storage																																																																																										
4F	OT_FAULT_LIMIT Value may be locked	Sets the overtemperature fault level in °C <table border="1"> <thead> <tr> <th>Format</th> <th colspan="9">Linear, two's complement binary</th> </tr> </thead> <tbody> <tr> <td>Bit Position</td> <td>7</td><td>6</td><td>5</td><td>4</td><td>3</td><td>2</td><td>1</td><td>0</td><td></td> </tr> <tr> <td>Access</td> <td>r</td><td>r</td><td>r</td><td>r</td><td>r</td><td>r</td><td>r</td><td>r</td><td></td> </tr> <tr> <td>Function</td> <td colspan="5">Exponent</td> <td colspan="4">Mantissa</td> </tr> <tr> <td>Default Value</td> <td>0</td><td>0</td><td>0</td><td>0</td><td>0</td><td>0</td><td>0</td><td>0</td><td></td> </tr> <tr> <td>Bit Position</td> <td>7</td><td>6</td><td>5</td><td>4</td><td>3</td><td>2</td><td>1</td><td>0</td><td></td> </tr> <tr> <td>Access</td> <td>r/w</td><td>r/w</td><td>r/w</td><td>r/w</td><td>r/w</td><td>r/w</td><td>r/w</td><td>r/w</td><td></td> </tr> <tr> <td>Function</td> <td colspan="9">Mantissa</td> </tr> <tr> <td>Default Value</td> <td>1</td><td>0</td><td>0</td><td>0</td><td>0</td><td>1</td><td>1</td><td>1</td><td></td> </tr> </tbody> </table>	Format	Linear, two's complement binary									Bit Position	7	6	5	4	3	2	1	0		Access	r	r	r	r	r	r	r	r		Function	Exponent					Mantissa				Default Value	0	0	0	0	0	0	0	0		Bit Position	7	6	5	4	3	2	1	0		Access	r/w	r/w	r/w	r/w	r/w	r/w	r/w	r/w		Function	Mantissa									Default Value	1	0	0	0	0	1	1	1		YES
Format	Linear, two's complement binary																																																																																												
Bit Position	7	6	5	4	3	2	1	0																																																																																					
Access	r	r	r	r	r	r	r	r																																																																																					
Function	Exponent					Mantissa																																																																																							
Default Value	0	0	0	0	0	0	0	0																																																																																					
Bit Position	7	6	5	4	3	2	1	0																																																																																					
Access	r/w	r/w	r/w	r/w	r/w	r/w	r/w	r/w																																																																																					
Function	Mantissa																																																																																												
Default Value	1	0	0	0	0	1	1	1																																																																																					
51	OT_WARN_LIMIT Value may be locked	Sets the over temperature warning level in °C <table border="1"> <thead> <tr> <th>Format</th> <th colspan="9">Linear, two's complement binary</th> </tr> </thead> <tbody> <tr> <td>Bit Position</td> <td>7</td><td>6</td><td>5</td><td>4</td><td>3</td><td>2</td><td>1</td><td>0</td><td></td> </tr> <tr> <td>Access</td> <td>r</td><td>r</td><td>r</td><td>r</td><td>r</td><td>r</td><td>r</td><td>r</td><td></td> </tr> <tr> <td>Function</td> <td colspan="5">Exponent</td> <td colspan="4">Mantissa</td> </tr> <tr> <td>Default Value</td> <td>0</td><td>0</td><td>0</td><td>0</td><td>0</td><td>0</td><td>0</td><td>0</td><td></td> </tr> <tr> <td>Bit Position</td> <td>7</td><td>6</td><td>5</td><td>4</td><td>3</td><td>2</td><td>1</td><td>0</td><td></td> </tr> <tr> <td>Access</td> <td>r/w</td><td>r/w</td><td>r/w</td><td>r/w</td><td>r/w</td><td>r/w</td><td>r/w</td><td>r/w</td><td></td> </tr> <tr> <td>Function</td> <td colspan="9">Mantissa</td> </tr> <tr> <td>Default Value</td> <td>0</td><td>1</td><td>1</td><td>1</td><td>1</td><td>1</td><td>0</td><td>1</td><td></td> </tr> </tbody> </table>	Format	Linear, two's complement binary									Bit Position	7	6	5	4	3	2	1	0		Access	r	r	r	r	r	r	r	r		Function	Exponent					Mantissa				Default Value	0	0	0	0	0	0	0	0		Bit Position	7	6	5	4	3	2	1	0		Access	r/w	r/w	r/w	r/w	r/w	r/w	r/w	r/w		Function	Mantissa									Default Value	0	1	1	1	1	1	0	1		YES
Format	Linear, two's complement binary																																																																																												
Bit Position	7	6	5	4	3	2	1	0																																																																																					
Access	r	r	r	r	r	r	r	r																																																																																					
Function	Exponent					Mantissa																																																																																							
Default Value	0	0	0	0	0	0	0	0																																																																																					
Bit Position	7	6	5	4	3	2	1	0																																																																																					
Access	r/w	r/w	r/w	r/w	r/w	r/w	r/w	r/w																																																																																					
Function	Mantissa																																																																																												
Default Value	0	1	1	1	1	1	0	1																																																																																					
61	TON_RISE	Sets the rise time of the output voltage during startup. Supported Values – 0.6, 0.9, 1.2, 1.8, 2.7, 4.2, 6.0, 9.0msec. Value of 0 instructs unit to bring its output to programmed value as quickly as possible <table border="1"> <thead> <tr> <th>Format</th> <th colspan="9">Linear, two's complement binary</th> </tr> </thead> <tbody> <tr> <td>Bit Position</td> <td>7</td><td>6</td><td>5</td><td>4</td><td>3</td><td>2</td><td>1</td><td>0</td><td></td> </tr> <tr> <td>Access</td> <td>r</td><td>r</td><td>r</td><td>r</td><td>r</td><td>r</td><td>r</td><td>r/w</td><td></td> </tr> <tr> <td>Function</td> <td colspan="5">Exponent</td> <td colspan="4">Mantissa</td> </tr> <tr> <td>Default Value</td> <td>1</td><td>1</td><td>1</td><td>0</td><td>0</td><td>0</td><td>0</td><td>0</td><td></td> </tr> <tr> <td>Bit Position</td> <td>7</td><td>6</td><td>5</td><td>4</td><td>3</td><td>2</td><td>1</td><td>0</td><td></td> </tr> <tr> <td>Access</td> <td>r/w</td><td>r/w</td><td>r/w</td><td>r/w</td><td>r/w</td><td>r/w</td><td>r/w</td><td>r/w</td><td></td> </tr> <tr> <td>Function</td> <td colspan="9">Mantissa</td> </tr> <tr> <td>Default Value</td> <td>0</td><td>0</td><td>1</td><td>0</td><td>1</td><td>0</td><td>1</td><td>1</td><td></td> </tr> </tbody> </table>	Format	Linear, two's complement binary									Bit Position	7	6	5	4	3	2	1	0		Access	r	r	r	r	r	r	r	r/w		Function	Exponent					Mantissa				Default Value	1	1	1	0	0	0	0	0		Bit Position	7	6	5	4	3	2	1	0		Access	r/w	r/w	r/w	r/w	r/w	r/w	r/w	r/w		Function	Mantissa									Default Value	0	0	1	0	1	0	1	1		YES
Format	Linear, two's complement binary																																																																																												
Bit Position	7	6	5	4	3	2	1	0																																																																																					
Access	r	r	r	r	r	r	r	r/w																																																																																					
Function	Exponent					Mantissa																																																																																							
Default Value	1	1	1	0	0	0	0	0																																																																																					
Bit Position	7	6	5	4	3	2	1	0																																																																																					
Access	r/w	r/w	r/w	r/w	r/w	r/w	r/w	r/w																																																																																					
Function	Mantissa																																																																																												
Default Value	0	0	1	0	1	0	1	1																																																																																					
78	STATUS_BYTE	Returns one byte of information with a summary of the most critical module faults <table border="1"> <thead> <tr> <th>Format</th> <th colspan="8">Unsigned Binary</th> </tr> </thead> <tbody> <tr> <td>Bit Position</td> <td>7</td><td>6</td><td>5</td><td>4</td><td>3</td><td>2</td><td>1</td><td>0</td><td></td> </tr> <tr> <td>Access</td> <td>r</td><td>r</td><td>r</td><td>r</td><td>r</td><td>r</td><td>r</td><td>r</td><td></td> </tr> <tr> <td>Flag</td> <td>X</td><td>OFF</td><td>VOUT_OV</td><td>IOUT_OC</td><td>VIN_UV</td><td>TEMP</td><td>CML</td><td>None of the Above</td><td></td> </tr> <tr> <td>Default Value</td> <td>0</td><td>0</td><td>0</td><td>0</td><td>0</td><td>0</td><td>0</td><td>0</td><td></td> </tr> </tbody> </table>	Format	Unsigned Binary								Bit Position	7	6	5	4	3	2	1	0		Access	r	r	r	r	r	r	r	r		Flag	X	OFF	VOUT_OV	IOUT_OC	VIN_UV	TEMP	CML	None of the Above		Default Value	0	0	0	0	0	0	0	0																																											
Format	Unsigned Binary																																																																																												
Bit Position	7	6	5	4	3	2	1	0																																																																																					
Access	r	r	r	r	r	r	r	r																																																																																					
Flag	X	OFF	VOUT_OV	IOUT_OC	VIN_UV	TEMP	CML	None of the Above																																																																																					
Default Value	0	0	0	0	0	0	0	0																																																																																					
79	STATUS_WORD	Returns two bytes of information with a summary of the module's fault/warning conditions <table border="1"> <thead> <tr> <th>Format</th> <th colspan="8">Unsigned Binary</th> </tr> </thead> <tbody> <tr> <td>Bit Position</td> <td>7</td><td>6</td><td>5</td><td>4</td><td>3</td><td>2</td><td>1</td><td>0</td><td></td> </tr> <tr> <td>Access</td> <td>r</td><td>r</td><td>r</td><td>r</td><td>r</td><td>r</td><td>r</td><td>r</td><td></td> </tr> <tr> <td>Flag</td> <td>VOUT</td><td>IOUT/P OUT</td><td>X</td><td>MFR</td><td>PGOOD</td><td>X</td><td>X</td><td></td><td></td> </tr> <tr> <td>Default Value</td> <td>0</td><td>0</td><td>0</td><td>0</td><td>0</td><td>0</td><td>0</td><td></td><td></td> </tr> <tr> <td>Bit Position</td> <td>7</td><td>6</td><td>5</td><td>4</td><td>3</td><td>2</td><td>1</td><td>0</td><td></td> </tr> <tr> <td>Access</td> <td>r</td><td>r</td><td>r</td><td>r</td><td>r</td><td>r</td><td>r</td><td>r</td><td></td> </tr> <tr> <td>Flag</td> <td>X</td><td>OFF</td><td>VOUT_OV</td><td>IOUT_OC</td><td>VIN_UV</td><td>TEMP</td><td>CML</td><td>No at</td><td></td> </tr> <tr> <td>Default Value</td> <td>0</td><td>X</td><td>0</td><td>0</td><td>0</td><td>0</td><td>0</td><td></td><td></td> </tr> </tbody> </table>	Format	Unsigned Binary								Bit Position	7	6	5	4	3	2	1	0		Access	r	r	r	r	r	r	r	r		Flag	VOUT	IOUT/P OUT	X	MFR	PGOOD	X	X			Default Value	0	0	0	0	0	0	0			Bit Position	7	6	5	4	3	2	1	0		Access	r	r	r	r	r	r	r	r		Flag	X	OFF	VOUT_OV	IOUT_OC	VIN_UV	TEMP	CML	No at		Default Value	0	X	0	0	0	0	0				
Format	Unsigned Binary																																																																																												
Bit Position	7	6	5	4	3	2	1	0																																																																																					
Access	r	r	r	r	r	r	r	r																																																																																					
Flag	VOUT	IOUT/P OUT	X	MFR	PGOOD	X	X																																																																																						
Default Value	0	0	0	0	0	0	0																																																																																						
Bit Position	7	6	5	4	3	2	1	0																																																																																					
Access	r	r	r	r	r	r	r	r																																																																																					
Flag	X	OFF	VOUT_OV	IOUT_OC	VIN_UV	TEMP	CML	No at																																																																																					
Default Value	0	X	0	0	0	0	0																																																																																						
7A	STATUS_VOUT	Returns one byte of information with the status of the module's output voltage related faults <table border="1"> <thead> <tr> <th>Format</th> <th colspan="8">Unsigned Binary</th> </tr> </thead> <tbody> <tr> <td>Bit Position</td> <td>7</td><td>6</td><td>5</td><td>4</td><td>3</td><td>2</td><td>1</td><td>0</td><td></td> </tr> <tr> <td>Access</td> <td>r</td><td>r</td><td>r</td><td>r</td><td>r</td><td>r</td><td>r</td><td>r</td><td></td> </tr> <tr> <td>Flag</td> <td>VOUT_OV</td><td>X</td><td>X</td><td>VOUT_UV</td><td>X</td><td>X</td><td>X</td><td>X</td><td></td> </tr> <tr> <td>Default Value</td> <td>0</td><td>0</td><td>0</td><td>0</td><td>0</td><td>0</td><td>0</td><td>0</td><td></td> </tr> </tbody> </table>	Format	Unsigned Binary								Bit Position	7	6	5	4	3	2	1	0		Access	r	r	r	r	r	r	r	r		Flag	VOUT_OV	X	X	VOUT_UV	X	X	X	X		Default Value	0	0	0	0	0	0	0	0																																											
Format	Unsigned Binary																																																																																												
Bit Position	7	6	5	4	3	2	1	0																																																																																					
Access	r	r	r	r	r	r	r	r																																																																																					
Flag	VOUT_OV	X	X	VOUT_UV	X	X	X	X																																																																																					
Default Value	0	0	0	0	0	0	0	0																																																																																					

2 × 6A Digital Dual MicroDlynx™: Non-Isolated DC-DC Power Modules
 4.5Vdc –14.4Vdc input; 0.51Vdc to 5.5Vdc output; 2 × 6A Output Current

Hex Code	Command	Brief Description	Non-Volatile Memory Storage																																																																																	
7B	STATUS_IOUT	Returns one byte of information with the status of the module's output current related faults <table border="1"> <thead> <tr> <th>Format</th> <th colspan="8">Unsigned Binary</th> </tr> </thead> <tbody> <tr> <td>Bit Position</td> <td>7</td> <td>6</td> <td>5</td> <td>4</td> <td>3</td> <td>2</td> <td>1</td> <td>0</td> </tr> <tr> <td>Access</td> <td>r</td> <td>r</td> <td>r</td> <td>r</td> <td>r</td> <td>r</td> <td>r</td> <td>r</td> </tr> <tr> <td>Flag</td> <td>IOUT_OC Fault</td> <td>X</td> <td>IOUT OC Warning</td> <td>X</td> <td>X</td> <td>X</td> <td>X</td> <td>X</td> </tr> <tr> <td>Default Value</td> <td>0</td> <td>0</td> <td>0</td> <td>0</td> <td>0</td> <td>0</td> <td>0</td> <td>0</td> </tr> </tbody> </table>	Format	Unsigned Binary								Bit Position	7	6	5	4	3	2	1	0	Access	r	r	r	r	r	r	r	r	Flag	IOUT_OC Fault	X	IOUT OC Warning	X	X	X	X	X	Default Value	0	0	0	0	0	0	0	0																																					
Format	Unsigned Binary																																																																																			
Bit Position	7	6	5	4	3	2	1	0																																																																												
Access	r	r	r	r	r	r	r	r																																																																												
Flag	IOUT_OC Fault	X	IOUT OC Warning	X	X	X	X	X																																																																												
Default Value	0	0	0	0	0	0	0	0																																																																												
7D	STATUS_TEMPERATURE	Returns one byte of information with the status of the module's temperature related faults <table border="1"> <thead> <tr> <th>Format</th> <th colspan="8">Unsigned Binary</th> </tr> </thead> <tbody> <tr> <td>Bit Position</td> <td>7</td> <td>6</td> <td>5</td> <td>4</td> <td>3</td> <td>2</td> <td>1</td> <td>0</td> </tr> <tr> <td>Access</td> <td>r</td> <td>r</td> <td>r</td> <td>r</td> <td>r</td> <td>r</td> <td>r</td> <td>r</td> </tr> <tr> <td>Flag</td> <td>OT_FAULT</td> <td>OT_WARN</td> <td>X</td> <td>X</td> <td>X</td> <td>X</td> <td>X</td> <td>X</td> </tr> <tr> <td>Default Value</td> <td>0</td> <td>0</td> <td>0</td> <td>0</td> <td>0</td> <td>0</td> <td>0</td> <td>0</td> </tr> </tbody> </table>	Format	Unsigned Binary								Bit Position	7	6	5	4	3	2	1	0	Access	r	r	r	r	r	r	r	r	Flag	OT_FAULT	OT_WARN	X	X	X	X	X	X	Default Value	0	0	0	0	0	0	0	0																																					
Format	Unsigned Binary																																																																																			
Bit Position	7	6	5	4	3	2	1	0																																																																												
Access	r	r	r	r	r	r	r	r																																																																												
Flag	OT_FAULT	OT_WARN	X	X	X	X	X	X																																																																												
Default Value	0	0	0	0	0	0	0	0																																																																												
7E	STATUS_CML	Returns one byte of information with the status of the module's communication related faults <table border="1"> <thead> <tr> <th>Format</th> <th colspan="8">Unsigned Binary</th> </tr> </thead> <tbody> <tr> <td>Bit Position</td> <td>7</td> <td>6</td> <td>5</td> <td>4</td> <td>3</td> <td>2</td> <td>1</td> <td>0</td> </tr> <tr> <td>Access</td> <td>r</td> <td>r</td> <td>r</td> <td>r</td> <td>r</td> <td>r</td> <td>r</td> <td>r</td> </tr> <tr> <td>Flag</td> <td>Invalid Command</td> <td>Invalid Data</td> <td>PEC Fail</td> <td>Memory fault detected</td> <td>X</td> <td>X</td> <td>Other Comm Fault</td> <td>X</td> </tr> <tr> <td>Default Value</td> <td>0</td> <td>0</td> <td>0</td> <td>0</td> <td>0</td> <td>0</td> <td>0</td> <td>0</td> </tr> </tbody> </table>	Format	Unsigned Binary								Bit Position	7	6	5	4	3	2	1	0	Access	r	r	r	r	r	r	r	r	Flag	Invalid Command	Invalid Data	PEC Fail	Memory fault detected	X	X	Other Comm Fault	X	Default Value	0	0	0	0	0	0	0	0																																					
Format	Unsigned Binary																																																																																			
Bit Position	7	6	5	4	3	2	1	0																																																																												
Access	r	r	r	r	r	r	r	r																																																																												
Flag	Invalid Command	Invalid Data	PEC Fail	Memory fault detected	X	X	Other Comm Fault	X																																																																												
Default Value	0	0	0	0	0	0	0	0																																																																												
80	STATUS_MFR_SPECIFIC	Returns one byte of information with the status of the module specific faults or warning <table border="1"> <thead> <tr> <th>Format</th> <th colspan="8">Unsigned Binary</th> </tr> </thead> <tbody> <tr> <td>Bit Position</td> <td>7</td> <td>6</td> <td>5</td> <td>4</td> <td>3</td> <td>2</td> <td>1</td> <td>0</td> </tr> <tr> <td>Access</td> <td>r</td> <td>r</td> <td>r</td> <td>r</td> <td>r</td> <td>r</td> <td>r</td> <td>R</td> </tr> <tr> <td>Flag</td> <td>OTFI</td> <td>x</td> <td>X</td> <td>IVADDR</td> <td>X</td> <td>X</td> <td>X</td> <td>TWOPH_EN</td> </tr> <tr> <td>Default Value</td> <td>0</td> <td>0</td> <td>0</td> <td>0</td> <td>0</td> <td>0</td> <td>0</td> <td>0</td> </tr> </tbody> </table> OTFI – Internal Temperature above Thermal Shutdown threshold IVADDR – PMBUs address is not valid TWOPH_EN – Module is in 2 phase mode	Format	Unsigned Binary								Bit Position	7	6	5	4	3	2	1	0	Access	r	r	r	r	r	r	r	R	Flag	OTFI	x	X	IVADDR	X	X	X	TWOPH_EN	Default Value	0	0	0	0	0	0	0	0																																					
Format	Unsigned Binary																																																																																			
Bit Position	7	6	5	4	3	2	1	0																																																																												
Access	r	r	r	r	r	r	r	R																																																																												
Flag	OTFI	x	X	IVADDR	X	X	X	TWOPH_EN																																																																												
Default Value	0	0	0	0	0	0	0	0																																																																												
8B	READ_VOUT	Returns the value of the output voltage of the module. Exponent is fixed at -9. <table border="1"> <thead> <tr> <th>Format</th> <th colspan="8">Linear, two's complement binary</th> </tr> </thead> <tbody> <tr> <td>Bit Position</td> <td>7</td> <td>6</td> <td>5</td> <td>4</td> <td>3</td> <td>2</td> <td>1</td> <td>0</td> </tr> <tr> <td>Access</td> <td>r</td> <td>r</td> <td>r</td> <td>r</td> <td>r</td> <td>r</td> <td>r</td> <td>r</td> </tr> <tr> <td>Function</td> <td colspan="8">Mantissa</td> </tr> <tr> <td>Default Value</td> <td>0</td> <td>0</td> <td>0</td> <td>0</td> <td>0</td> <td>0</td> <td>0</td> <td>0</td> </tr> <tr> <td>Bit Position</td> <td>7</td> <td>6</td> <td>5</td> <td>4</td> <td>3</td> <td>2</td> <td>1</td> <td>0</td> </tr> <tr> <td>Access</td> <td>r</td> <td>r</td> <td>r</td> <td>r</td> <td>r</td> <td>r</td> <td>r</td> <td>r</td> </tr> <tr> <td>Function</td> <td colspan="8">Mantissa</td> </tr> <tr> <td>Default Value</td> <td>0</td> <td>0</td> <td>0</td> <td>0</td> <td>0</td> <td>0</td> <td>0</td> <td>0</td> </tr> </tbody> </table>	Format	Linear, two's complement binary								Bit Position	7	6	5	4	3	2	1	0	Access	r	r	r	r	r	r	r	r	Function	Mantissa								Default Value	0	0	0	0	0	0	0	0	Bit Position	7	6	5	4	3	2	1	0	Access	r	r	r	r	r	r	r	r	Function	Mantissa								Default Value	0	0	0	0	0	0	0	0	
Format	Linear, two's complement binary																																																																																			
Bit Position	7	6	5	4	3	2	1	0																																																																												
Access	r	r	r	r	r	r	r	r																																																																												
Function	Mantissa																																																																																			
Default Value	0	0	0	0	0	0	0	0																																																																												
Bit Position	7	6	5	4	3	2	1	0																																																																												
Access	r	r	r	r	r	r	r	r																																																																												
Function	Mantissa																																																																																			
Default Value	0	0	0	0	0	0	0	0																																																																												
8C	READ_IOUT	Returns the value of the output current of the module <table border="1"> <thead> <tr> <th>Format</th> <th colspan="8">Linear, two's complement binary</th> </tr> </thead> <tbody> <tr> <td>Bit Position</td> <td>7</td> <td>6</td> <td>5</td> <td>4</td> <td>3</td> <td>2</td> <td>1</td> <td>0</td> </tr> <tr> <td>Access</td> <td>r</td> <td>r</td> <td>r</td> <td>r</td> <td>R</td> <td>r</td> <td>r</td> <td>r</td> </tr> <tr> <td>Function</td> <td colspan="4">Exponent</td> <td colspan="4">Mantissa</td> </tr> <tr> <td>Default Value</td> <td>1</td> <td>1</td> <td>1</td> <td>0</td> <td>0</td> <td>V</td> <td>V</td> <td>V</td> </tr> <tr> <td>Bit Position</td> <td>7</td> <td>6</td> <td>5</td> <td>4</td> <td>3</td> <td>2</td> <td>1</td> <td>0</td> </tr> <tr> <td>Access</td> <td>r</td> <td>r</td> <td>r</td> <td>r</td> <td>r</td> <td>r</td> <td>r</td> <td>r</td> </tr> <tr> <td>Function</td> <td colspan="8">Mantissa</td> </tr> <tr> <td>Default Value</td> <td>V</td> <td>V</td> <td>V</td> <td>V</td> <td>V</td> <td>V</td> <td>V</td> <td>0</td> </tr> </tbody> </table> V - Variable	Format	Linear, two's complement binary								Bit Position	7	6	5	4	3	2	1	0	Access	r	r	r	r	R	r	r	r	Function	Exponent				Mantissa				Default Value	1	1	1	0	0	V	V	V	Bit Position	7	6	5	4	3	2	1	0	Access	r	r	r	r	r	r	r	r	Function	Mantissa								Default Value	V	V	V	V	V	V	V	0	
Format	Linear, two's complement binary																																																																																			
Bit Position	7	6	5	4	3	2	1	0																																																																												
Access	r	r	r	r	R	r	r	r																																																																												
Function	Exponent				Mantissa																																																																															
Default Value	1	1	1	0	0	V	V	V																																																																												
Bit Position	7	6	5	4	3	2	1	0																																																																												
Access	r	r	r	r	r	r	r	r																																																																												
Function	Mantissa																																																																																			
Default Value	V	V	V	V	V	V	V	0																																																																												

2 × 6A Digital Dual MicroDlynx™: Non-Isolated DC-DC Power Modules
 4.5Vdc –14.4Vdc input; 0.51Vdc to 5.5Vdc output; 2 × 6A Output Current

Table 6 (Continued)

Hex Code	Command	Brief Description	Non-Volatile Memory Storage																																																																																	
8E	READ_TEMPERATURE_2	<p>Returns the value of the external temperature in degree Celsius</p> <table border="1"> <thead> <tr> <th>Format</th> <th colspan="8">Linear, two's complement binary</th> </tr> </thead> <tbody> <tr> <td>Bit Position</td> <td>7</td> <td>6</td> <td>5</td> <td>4</td> <td>3</td> <td>2</td> <td>1</td> <td>0</td> </tr> <tr> <td>Access</td> <td>r</td> <td>r</td> <td>r</td> <td>r</td> <td>R</td> <td>r</td> <td>r</td> <td>r</td> </tr> <tr> <td>Function</td> <td colspan="4">Exponent</td> <td colspan="4">Mantissa</td> </tr> <tr> <td>Default Value</td> <td>0</td> <td>0</td> <td>0</td> <td>0</td> <td>0</td> <td>V</td> <td>V</td> <td>V</td> </tr> <tr> <td>Bit Position</td> <td>7</td> <td>6</td> <td>5</td> <td>4</td> <td>3</td> <td>2</td> <td>1</td> <td>0</td> </tr> <tr> <td>Access</td> <td>r</td> <td>r</td> <td>r</td> <td>r</td> <td>r</td> <td>r</td> <td>r</td> <td>r</td> </tr> <tr> <td>Function</td> <td colspan="8">Mantissa</td> </tr> <tr> <td>Default Value</td> <td>V</td> <td>V</td> <td>V</td> <td>V</td> <td>V</td> <td>V</td> <td>V</td> <td>0</td> </tr> </tbody> </table> <p>V - Variable</p>	Format	Linear, two's complement binary								Bit Position	7	6	5	4	3	2	1	0	Access	r	r	r	r	R	r	r	r	Function	Exponent				Mantissa				Default Value	0	0	0	0	0	V	V	V	Bit Position	7	6	5	4	3	2	1	0	Access	r	r	r	r	r	r	r	r	Function	Mantissa								Default Value	V	V	V	V	V	V	V	0	
Format	Linear, two's complement binary																																																																																			
Bit Position	7	6	5	4	3	2	1	0																																																																												
Access	r	r	r	r	R	r	r	r																																																																												
Function	Exponent				Mantissa																																																																															
Default Value	0	0	0	0	0	V	V	V																																																																												
Bit Position	7	6	5	4	3	2	1	0																																																																												
Access	r	r	r	r	r	r	r	r																																																																												
Function	Mantissa																																																																																			
Default Value	V	V	V	V	V	V	V	0																																																																												
98	PMBUS_REVISION	<p>Returns one byte indicating the module is compliant to PMBus Spec. 1.1 (read only)</p> <table border="1"> <thead> <tr> <th>Format</th> <th colspan="8">Unsigned Binary</th> </tr> </thead> <tbody> <tr> <td>Bit Position</td> <td>7</td> <td>6</td> <td>5</td> <td>4</td> <td>3</td> <td>2</td> <td>1</td> <td>0</td> </tr> <tr> <td>Access</td> <td>r</td> <td>r</td> <td>r</td> <td>r</td> <td>r</td> <td>r</td> <td>r</td> <td>r</td> </tr> <tr> <td>Default Value</td> <td>0</td> <td>0</td> <td>0</td> <td>1</td> <td>0</td> <td>0</td> <td>0</td> <td>1</td> </tr> </tbody> </table>	Format	Unsigned Binary								Bit Position	7	6	5	4	3	2	1	0	Access	r	r	r	r	r	r	r	r	Default Value	0	0	0	1	0	0	0	1																																														
Format	Unsigned Binary																																																																																			
Bit Position	7	6	5	4	3	2	1	0																																																																												
Access	r	r	r	r	r	r	r	r																																																																												
Default Value	0	0	0	1	0	0	0	1																																																																												
D0	MFR_SPECIFIC_00	<p>Returns module name information</p> <table border="1"> <thead> <tr> <th>Format</th> <th colspan="8">Unsigned Binary</th> </tr> </thead> <tbody> <tr> <td>Bit Position</td> <td>7</td> <td>6</td> <td>5</td> <td>4</td> <td>3</td> <td>2</td> <td>1</td> <td>0</td> </tr> <tr> <td>Access</td> <td>r</td> <td>r</td> <td>r</td> <td>r</td> <td>r</td> <td>r</td> <td>r</td> <td>r</td> </tr> <tr> <td>Function</td> <td colspan="8">Reserved</td> </tr> <tr> <td>Default Value</td> <td>0</td> <td>0</td> <td>0</td> <td>0</td> <td>0</td> <td>0</td> <td>0</td> <td>0</td> </tr> <tr> <td>Bit Position</td> <td>7</td> <td>6</td> <td>5</td> <td>4</td> <td>3</td> <td>2</td> <td>1</td> <td>0</td> </tr> <tr> <td>Access</td> <td>r</td> <td>r</td> <td>r</td> <td>r</td> <td>r</td> <td>r</td> <td>r</td> <td>r</td> </tr> <tr> <td>Function</td> <td colspan="6">Module Name</td> <td colspan="2">Reserved</td> </tr> <tr> <td>Default Value</td> <td>0</td> <td>0</td> <td>0</td> <td>0</td> <td>1</td> <td>1</td> <td>1</td> <td>0</td> </tr> </tbody> </table>	Format	Unsigned Binary								Bit Position	7	6	5	4	3	2	1	0	Access	r	r	r	r	r	r	r	r	Function	Reserved								Default Value	0	0	0	0	0	0	0	0	Bit Position	7	6	5	4	3	2	1	0	Access	r	r	r	r	r	r	r	r	Function	Module Name						Reserved		Default Value	0	0	0	0	1	1	1	0	YES
Format	Unsigned Binary																																																																																			
Bit Position	7	6	5	4	3	2	1	0																																																																												
Access	r	r	r	r	r	r	r	r																																																																												
Function	Reserved																																																																																			
Default Value	0	0	0	0	0	0	0	0																																																																												
Bit Position	7	6	5	4	3	2	1	0																																																																												
Access	r	r	r	r	r	r	r	r																																																																												
Function	Module Name						Reserved																																																																													
Default Value	0	0	0	0	1	1	1	0																																																																												
D4	VREF_TRIM	<p>Applies a fixed offset to the reference voltage. Max trim range is -20% to +10% in 2mV steps. Permissible values range between -120mV and +60mV. The offset is calculated as $VREF_TRIM \times 2^{-9}$. Exponent fixed at -9(dec)</p> <table border="1"> <thead> <tr> <th>Format</th> <th colspan="8">Linear, two's complement binary</th> </tr> </thead> <tbody> <tr> <td>Bit Position</td> <td>7</td> <td>6</td> <td>5</td> <td>4</td> <td>3</td> <td>2</td> <td>1</td> <td>0</td> </tr> <tr> <td>Access</td> <td>r/w</td> <td>r</td> <td>r</td> <td>r</td> <td>r</td> <td>r</td> <td>r</td> <td>r</td> </tr> <tr> <td>Function</td> <td colspan="8">Mantissa</td> </tr> <tr> <td>Default Value</td> <td>V</td> <td>V</td> <td>V</td> <td>V</td> <td>V</td> <td>V</td> <td>V</td> <td>V</td> </tr> <tr> <td>Bit Position</td> <td>7</td> <td>6</td> <td>5</td> <td>4</td> <td>3</td> <td>2</td> <td>1</td> <td>0</td> </tr> <tr> <td>Access</td> <td>r</td> <td>r</td> <td>r/w</td> <td>r/w</td> <td>r/w</td> <td>r/w</td> <td>r/w</td> <td>r/w</td> </tr> <tr> <td>Function</td> <td colspan="8">Mantissa</td> </tr> <tr> <td>Default Value</td> <td>V</td> <td>V</td> <td>V</td> <td>V</td> <td>V</td> <td>V</td> <td>V</td> <td>V</td> </tr> </tbody> </table>	Format	Linear, two's complement binary								Bit Position	7	6	5	4	3	2	1	0	Access	r/w	r	r	r	r	r	r	r	Function	Mantissa								Default Value	V	V	V	V	V	V	V	V	Bit Position	7	6	5	4	3	2	1	0	Access	r	r	r/w	r/w	r/w	r/w	r/w	r/w	Function	Mantissa								Default Value	V	V	V	V	V	V	V	V	YES
Format	Linear, two's complement binary																																																																																			
Bit Position	7	6	5	4	3	2	1	0																																																																												
Access	r/w	r	r	r	r	r	r	r																																																																												
Function	Mantissa																																																																																			
Default Value	V	V	V	V	V	V	V	V																																																																												
Bit Position	7	6	5	4	3	2	1	0																																																																												
Access	r	r	r/w	r/w	r/w	r/w	r/w	r/w																																																																												
Function	Mantissa																																																																																			
Default Value	V	V	V	V	V	V	V	V																																																																												
D5	STEP_VREF_MARGIN_HIGH	<p>Applies a fixed offset to the reference voltage. Adjustment is 0% to +10% in 2mV steps. Permissible values range between 0mV and +60mV. The offset is calculated as $(STEP_VREF_MARGIN_HIGH + VREF_TRIM) \times 2^{-9}$. Exponent fixed at -9(dec). Net output voltage includes VREF_TRIM adjustment and ranges from -30% to 10%</p> <table border="1"> <thead> <tr> <th>Format</th> <th colspan="8">Linear, two's complement binary</th> </tr> </thead> <tbody> <tr> <td>Bit Position</td> <td>7</td> <td>6</td> <td>5</td> <td>4</td> <td>3</td> <td>2</td> <td>1</td> <td>0</td> </tr> <tr> <td>Access</td> <td>r</td> <td>r</td> <td>r</td> <td>r</td> <td>r</td> <td>r</td> <td>r</td> <td>r</td> </tr> <tr> <td>Function</td> <td colspan="8">Mantissa</td> </tr> <tr> <td>Default Value</td> <td>V</td> <td>V</td> <td>V</td> <td>V</td> <td>V</td> <td>V</td> <td>V</td> <td>V</td> </tr> <tr> <td>Bit Position</td> <td>7</td> <td>6</td> <td>5</td> <td>4</td> <td>3</td> <td>2</td> <td>1</td> <td>0</td> </tr> <tr> <td>Access</td> <td>r</td> <td>r</td> <td>r</td> <td>r/w</td> <td>r/w</td> <td>r/w</td> <td>r/w</td> <td>r/w</td> </tr> <tr> <td>Function</td> <td colspan="8">Mantissa</td> </tr> <tr> <td>Default Value</td> <td>V</td> <td>V</td> <td>V</td> <td>V</td> <td>V</td> <td>V</td> <td>V</td> <td>V</td> </tr> </tbody> </table>	Format	Linear, two's complement binary								Bit Position	7	6	5	4	3	2	1	0	Access	r	r	r	r	r	r	r	r	Function	Mantissa								Default Value	V	V	V	V	V	V	V	V	Bit Position	7	6	5	4	3	2	1	0	Access	r	r	r	r/w	r/w	r/w	r/w	r/w	Function	Mantissa								Default Value	V	V	V	V	V	V	V	V	YES
Format	Linear, two's complement binary																																																																																			
Bit Position	7	6	5	4	3	2	1	0																																																																												
Access	r	r	r	r	r	r	r	r																																																																												
Function	Mantissa																																																																																			
Default Value	V	V	V	V	V	V	V	V																																																																												
Bit Position	7	6	5	4	3	2	1	0																																																																												
Access	r	r	r	r/w	r/w	r/w	r/w	r/w																																																																												
Function	Mantissa																																																																																			
Default Value	V	V	V	V	V	V	V	V																																																																												

2 × 6A Digital Dual MicroDlynx™: Non-Isolated DC-DC Power Modules
 4.5Vdc –14.4Vdc input; 0.51Vdc to 5.5Vdc output; 2 × 6A Output Current

Table 6 (Continued)

Hex Code	Command	Brief Description	Non-Volatile Memory Storage																																																																																						
D6	STEP_VREF_MARGIN_LOW	<p>Applies a fixed negative offset to the reference voltage. Adjustment is -20% to 0% in 2mV steps. Permissible values range between -120mV and 0mV) The offset is calculated as (STEP_VREF_MARGIN_LOW + VREF_TRIM)x2⁻⁹. Exponent fixed at -9(dec). Net output voltage includes VREF_TRIM adjustment and ranges from -30% to 10%</p> <table border="1"> <tr> <th>Format</th> <td colspan="9">Linear, two's complement binary</td> </tr> <tr> <th>Bit Position</th> <td>7</td><td>6</td><td>5</td><td>4</td><td>3</td><td>2</td><td>1</td><td>0</td> </tr> <tr> <th>Access</th> <td>r</td><td>r</td><td>r</td><td>r</td><td>r</td><td>r</td><td>r</td><td>r</td> </tr> <tr> <th>Function</th> <td colspan="9">Mantissa</td> </tr> <tr> <th>Default Value</th> <td>V</td><td>V</td><td>V</td><td>V</td><td>V</td><td>V</td><td>V</td><td>V</td> </tr> <tr> <th>Bit Position</th> <td>7</td><td>6</td><td>5</td><td>4</td><td>3</td><td>2</td><td>1</td><td>0</td> </tr> <tr> <th>Access</th> <td>r</td><td>r</td><td>r/w</td><td>r/w</td><td>r/w</td><td>r/w</td><td>r/w</td><td>r/w</td> </tr> <tr> <th>Function</th> <td colspan="9">Mantissa</td> </tr> <tr> <th>Default Value</th> <td>V</td><td>V</td><td>V</td><td>V</td><td>V</td><td>V</td><td>V</td><td>V</td> </tr> </table>	Format	Linear, two's complement binary									Bit Position	7	6	5	4	3	2	1	0	Access	r	r	r	r	r	r	r	r	Function	Mantissa									Default Value	V	V	V	V	V	V	V	V	Bit Position	7	6	5	4	3	2	1	0	Access	r	r	r/w	r/w	r/w	r/w	r/w	r/w	Function	Mantissa									Default Value	V	V	V	V	V	V	V	V	YES		
Format	Linear, two's complement binary																																																																																								
Bit Position	7	6	5	4	3	2	1	0																																																																																	
Access	r	r	r	r	r	r	r	r																																																																																	
Function	Mantissa																																																																																								
Default Value	V	V	V	V	V	V	V	V																																																																																	
Bit Position	7	6	5	4	3	2	1	0																																																																																	
Access	r	r	r/w	r/w	r/w	r/w	r/w	r/w																																																																																	
Function	Mantissa																																																																																								
Default Value	V	V	V	V	V	V	V	V																																																																																	
D7	PCT_VOUT_FAULT_PG_LIMIT	<p>Single command to set PGOOD, VOUT_UNDER_VOLTAGE(UV) and VOUT_OVER_VOLTAGE(OV) limits as percentage of nominal</p> <table border="1"> <tr> <th>Format</th> <td colspan="9">Unsigned Binary</td> </tr> <tr> <th>Bit Position</th> <td>7</td><td>6</td><td>5</td><td>4</td><td>3</td><td>2</td><td>1</td><td>0</td> </tr> <tr> <th>Access</th> <td>r</td><td>r</td><td>r</td><td>r</td><td>r</td><td>r</td><td>r/w</td><td>r/w</td> </tr> <tr> <th>Function</th> <td>X</td><td>X</td><td>X</td><td>X</td><td>X</td><td>X</td><td>PCT_MSB</td><td>PCT_LSB</td> </tr> <tr> <th>Default Value</th> <td>0</td><td>X</td><td>X</td><td>X</td><td>X</td><td>X</td><td>X</td><td>0</td> </tr> </table> <p>PAGE Command Truth Table</p> <table border="1"> <thead> <tr> <th>PCT_MSB</th> <th>PCT_LSB</th> <th>UV (%)</th> <th>PGL LOW (%)</th> <th>PGL HIGH (%)</th> <th>PGH HIGH (%)</th> <th>PGH LOW (%)</th> <th>OV (%)</th> </tr> </thead> <tbody> <tr> <td>0</td> <td>0</td> <td>-16.67</td> <td>-12.5</td> <td>-8.33</td> <td>12.5</td> <td>8.33</td> <td>16.67</td> </tr> <tr> <td>0</td> <td>1</td> <td>-12.5</td> <td>-8.33</td> <td>-4.17</td> <td>8.33</td> <td>4.17</td> <td>12.5</td> </tr> <tr> <td>1</td> <td>0</td> <td>-29.17</td> <td>-20.83</td> <td>-16.67</td> <td>8.33</td> <td>4.17</td> <td>12.5</td> </tr> <tr> <td>1</td> <td>1</td> <td>-41.67</td> <td>-37.5</td> <td>-33.33</td> <td>8.33</td> <td>4.17</td> <td>12.5</td> </tr> </tbody> </table>	Format	Unsigned Binary									Bit Position	7	6	5	4	3	2	1	0	Access	r	r	r	r	r	r	r/w	r/w	Function	X	X	X	X	X	X	PCT_MSB	PCT_LSB	Default Value	0	X	X	X	X	X	X	0	PCT_MSB	PCT_LSB	UV (%)	PGL LOW (%)	PGL HIGH (%)	PGH HIGH (%)	PGH LOW (%)	OV (%)	0	0	-16.67	-12.5	-8.33	12.5	8.33	16.67	0	1	-12.5	-8.33	-4.17	8.33	4.17	12.5	1	0	-29.17	-20.83	-16.67	8.33	4.17	12.5	1	1	-41.67	-37.5	-33.33	8.33	4.17	12.5	
Format	Unsigned Binary																																																																																								
Bit Position	7	6	5	4	3	2	1	0																																																																																	
Access	r	r	r	r	r	r	r/w	r/w																																																																																	
Function	X	X	X	X	X	X	PCT_MSB	PCT_LSB																																																																																	
Default Value	0	X	X	X	X	X	X	0																																																																																	
PCT_MSB	PCT_LSB	UV (%)	PGL LOW (%)	PGL HIGH (%)	PGH HIGH (%)	PGH LOW (%)	OV (%)																																																																																		
0	0	-16.67	-12.5	-8.33	12.5	8.33	16.67																																																																																		
0	1	-12.5	-8.33	-4.17	8.33	4.17	12.5																																																																																		
1	0	-29.17	-20.83	-16.67	8.33	4.17	12.5																																																																																		
1	1	-41.67	-37.5	-33.33	8.33	4.17	12.5																																																																																		
D8	SEQUENCE_TON_TOFF_DELAY	<p>Used to set delay to turn-on or turn-off modules as a ratio of TON_RISE. Values can range from 0 to 7 and are a multiple of TON_RISE TIME</p> <table border="1"> <tr> <th>Format</th> <td colspan="9">Unsigned Binary</td> </tr> <tr> <th>Bit Position</th> <td>7</td><td>6</td><td>5</td><td>4</td><td>3</td><td>2</td><td>1</td><td>0</td> </tr> <tr> <th>Access</th> <td>r/w</td><td>r/w</td><td>r/w</td><td>r</td><td>r/w</td><td>r/w</td><td>r/w</td><td>r</td> </tr> <tr> <th>Function</th> <td colspan="4">TON_DELAY</td> <td colspan="4">TOFF_DELAY</td> </tr> <tr> <th>Default Value</th> <td>0</td><td>0</td><td>0</td><td>0</td><td>0</td><td>0</td><td>0</td><td>0</td> </tr> </table>	Format	Unsigned Binary									Bit Position	7	6	5	4	3	2	1	0	Access	r/w	r/w	r/w	r	r/w	r/w	r/w	r	Function	TON_DELAY				TOFF_DELAY				Default Value	0	0	0	0	0	0	0	0																																									
Format	Unsigned Binary																																																																																								
Bit Position	7	6	5	4	3	2	1	0																																																																																	
Access	r/w	r/w	r/w	r	r/w	r/w	r/w	r																																																																																	
Function	TON_DELAY				TOFF_DELAY																																																																																				
Default Value	0	0	0	0	0	0	0	0																																																																																	

2 × 6A Digital Dual MicroDlynx™: Non-Isolated DC-DC Power Modules

4.5Vdc –14.4Vdc input; 0.51Vdc to 5.5Vdc output; 2 × 6A Output Current

Thermal Considerations

Power modules operate in a variety of thermal environments; however, sufficient cooling should always be provided to help ensure reliable operation.

Considerations include ambient temperature, airflow, module power dissipation, and the need for increased reliability. A reduction in the operating temperature of the module will result in an increase in reliability. The thermal data presented here is based on physical measurements taken in a wind tunnel. The test set-up is shown in Figure 49. The preferred airflow direction for the module is in Figure 50.

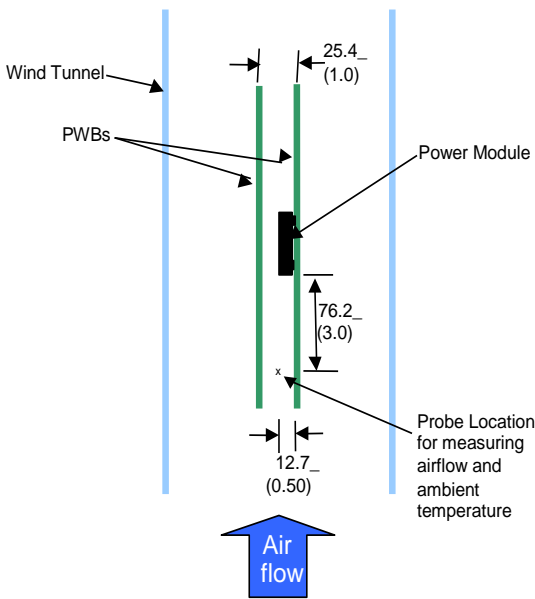

Figure 49. Thermal Test Setup.

The thermal reference points, T_{ref} used in the specifications are also shown in Figure 50. For reliable operation the temperatures at these points should not exceed 135°C. The output power of the module should not exceed the rated power of the module ($V_{o,set} \times I_{o,max}$).

Please refer to the Application Note “Thermal Characterization Process For Open-Frame Board-Mounted Power Modules” for a detailed discussion of thermal aspects including maximum device temperatures.

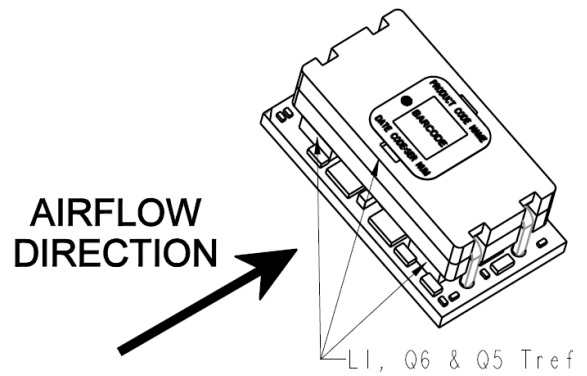

Figure 50. Preferred airflow direction and location of hot-spot of the module (T_{ref}).

2 × 6A Digital Dual MicroDlynx™: Non-Isolated DC-DC Power Modules

4.5Vdc –14.4Vdc input; 0.51Vdc to 5.5Vdc output; 2 × 6A Output Current

Shock and Vibration

The ruggedized (-D version) of the modules are designed to withstand elevated levels of shock and vibration to be able to operate in harsh environments. The ruggedized modules have been successfully tested to the following conditions:

Non operating random vibration:

Random vibration tests conducted at 25C, 10 to 2000Hz, for 30 minutes each level, starting from 30Grms (Z axis) and up to 50Grms (Z axis). The units were then subjected to two more tests of 50Grms at 30 minutes each for a total of 90 minutes.

Operating shock to 40G per Mil Std. 810F, Method 516.4 Procedure I:

The modules were tested in opposing directions along each of three orthogonal axes, with waveform and amplitude of the shock impulse characteristics as follows:

All shocks were half sine pulses, 11 milliseconds (ms) in duration in all 3 axes.

Units were tested to the Functional Shock Test of MIL-STD-810, Method 516.4, Procedure I - Figure 516.4-4. A shock magnitude of 40G was utilized. The operational units were subjected to three shocks in each direction along three axes for a total of eighteen shocks.

Operating vibration per Mil Std 810F, Method 514.5 Procedure I:

The ruggedized (-D version) modules are designed and tested to vibration levels as outlined in MIL-STD-810F, Method 514.5, and Procedure 1, using the Power Spectral Density (PSD) profiles as shown in Table 7 and Table 8 for all axes. Full compliance with performance specifications was required during the performance test. No damage was allowed to the module and full compliance to performance specifications was required when the endurance environment was removed. The module was tested per MIL-STD-810, Method 514.5, Procedure I, for functional (performance) and endurance random vibration using the performance and endurance levels shown in Table 7 and Table 8 for all axes. The performance test has been split, with one half accomplished before the endurance test and one half after the endurance test (in each axis). The duration of the performance test was at least 16 minutes total per axis and at least 120 minutes total per axis for the endurance test. The endurance test period was 2 hours minimum per axis.

Table 7: Performance Vibration Qualification - All Axes

Frequency (Hz)	PSD Level (G ² /Hz)	Frequency (Hz)	PSD Level (G ² /Hz)	Frequency (Hz)	PSD Level (G ² /Hz)
10	1.14E-03	170	2.54E-03	690	1.03E-03
30	5.96E-03	230	3.70E-03	800	7.29E-03
40	9.53E-04	290	7.99E-04	890	1.00E-03
50	2.08E-03	340	1.12E-02	1070	2.67E-03
90	2.08E-03	370	1.12E-02	1240	1.08E-03
110	7.05E-04	430	8.84E-04	1550	2.54E-03
130	5.00E-03	490	1.54E-03	1780	2.88E-03
140	8.20E-04	560	5.62E-04	2000	5.62E-04

Table 8: Endurance Vibration Qualification - All Axes

Frequency (Hz)	PSD Level (G ² /Hz)	Frequency (Hz)	PSD Level (G ² /Hz)	Frequency (Hz)	PSD Level (G ² /Hz)
10	0.00803	170	0.01795	690	0.00727
30	0.04216	230	0.02616	800	0.05155
40	0.00674	290	0.00565	890	0.00709
50	0.01468	340	0.07901	1070	0.01887
90	0.01468	370	0.07901	1240	0.00764
110	0.00498	430	0.00625	1550	0.01795
130	0.03536	490	0.01086	1780	0.02035
140	0.0058	560	0.00398	2000	0.00398

2 × 6A Digital Dual MicroDlynx™: Non-Isolated DC-DC Power Modules

4.5Vdc –14.4Vdc input; 0.51Vdc to 5.5Vdc output; 2 × 6A Output Current

Example Application Circuit

Requirements:

Vin:	12V
Vout:	1.8V
Iout:	2 × 4.5A max., worst case load transient is from 3A to 4.5A
ΔVout:	1.5% of Vout (27mV) for worst case load transient
Vin, ripple	1.5% of Vin (180mV, p-p)

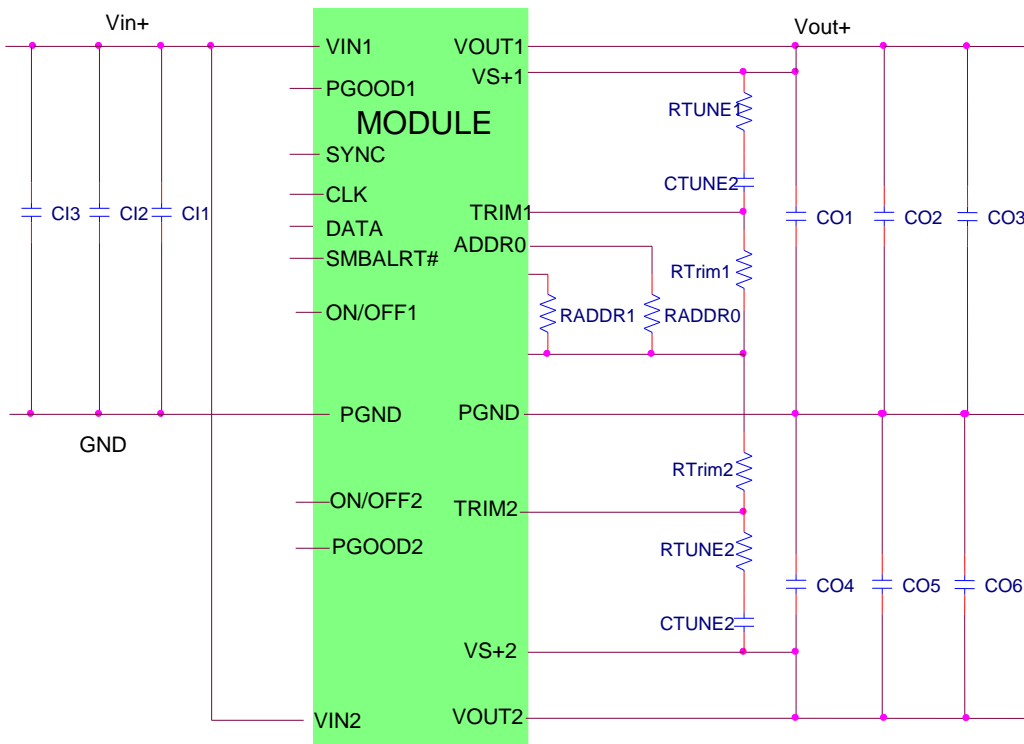

C1	Decoupling cap - 4×0.1μF/16V, 0402 size ceramic capacitor
C2	4×22μF/16V ceramic capacitor (e.g. Murata GRM32ER61C226KE20)
C3	470μF/16V bulk electrolytic
CO1	Decoupling cap - 2×0.1μF/16V, 0402 size ceramic capacitor
CO2	3 × 47μF/6.3V ceramic capacitor (e.g. Murata GRM31CR60J476ME19)
CO3	NA
CO4	Decoupling cap - 2×0.1μF/16V, 0402 size ceramic capacitor
CO5	3 × 47μF/6.3V ceramic capacitor (e.g. Murata GRM31CR60J476ME19)
CO6	NA
CTune1	1500pF ceramic capacitor (can be 1206, 0805 or 0603 size)
RTune1	300 ohms SMT resistor (can be 1206, 0805 or 0603 size)
RTrim1	10kΩ SMT resistor (can be 1206, 0805 or 0603 size, recommended tolerance of 0.1%)
CTune2	1500pF ceramic capacitor (can be 1206, 0805 or 0603 size)
RTune2	300 ohms SMT resistor (can be 1206, 0805 or 0603 size)
RTrim2	10kΩ SMT resistor (can be 1206, 0805 or 0603 size, recommended tolerance of 0.1%)

Note: The DATA, CLK and SMBALRT pins do not have any pull-up resistors inside the module. Typically, the SMBus master controller will have the pull-up resistors as well as provide the driving source for these signals.

2 × 6A Digital Dual MicroDlynx™: Non-Isolated DC-DC Power Modules

4.5Vdc –14.4Vdc input; 0.51Vdc to 5.5Vdc output; 2 × 6A Output Current

Mechanical Outline

Dimensions are in millimeters and (inches).

Tolerances: x.x mm ± 0.5 mm (x.xx in. ± 0.02 in.) [unless otherwise indicated]

x.xx mm ± 0.25 mm (x.xxx in. ± 0.010 in.)

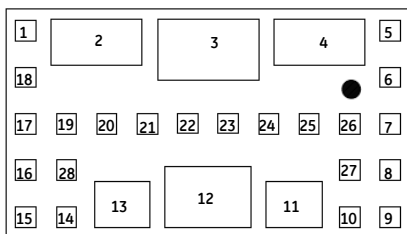
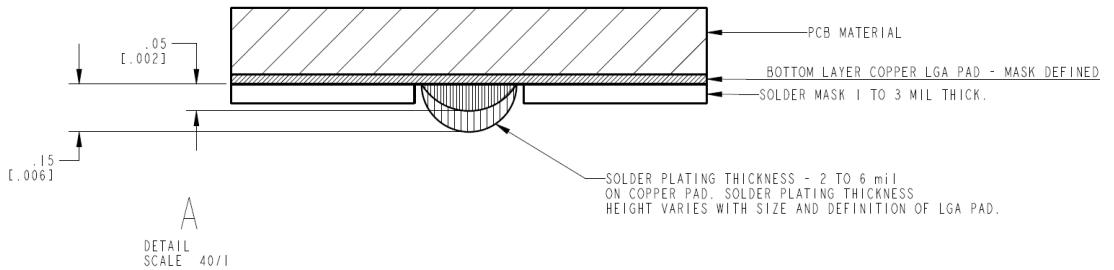
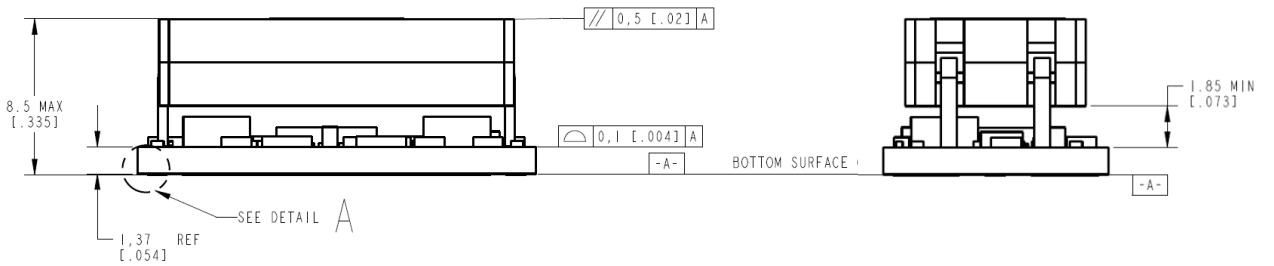
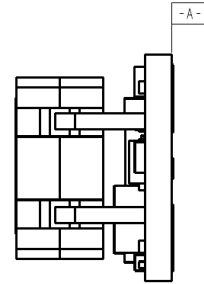
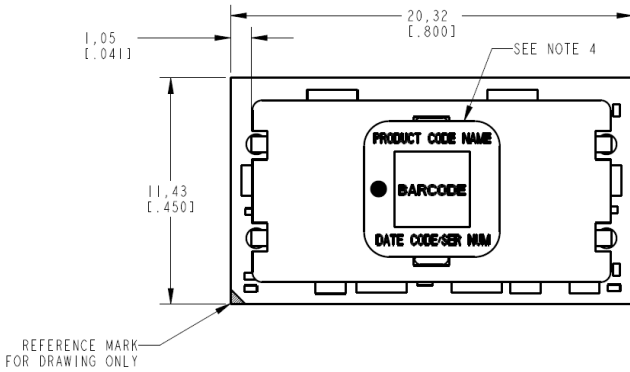

PIN	FUNCTION	PIN	FUNCTION
1	VSNS1	15	ADDR1
2	VOUT1	16	TRIM1
3	PGND	17	Sig_GND
4	VOUT2	18	TRIM2
5	VSNS2	19	SYNC
6	SMBALERT#	20	PGND
7	DATA	21	PGND
8	CLK	22	PGND
9	ENABLE1	23	PGND
10	ENABLE2	24	PGND
11	VIN	25	PGND
12	PGND	26	PGND
13	VIN	27	PGOOD2
14	ADDR0	28	PGOOD1

2 × 6A Digital Dual MicroDlynx™: Non-Isolated DC-DC Power Modules

4.5Vdc –14.4Vdc input; 0.51Vdc to 5.5Vdc output; 2 × 6A Output Current

Recommended Pad Layout

Dimensions are in millimeters and (inches).

Tolerances: x.xx mm ± 0.5 mm (x.xx in. ± 0.02 in.) [unless otherwise indicated]

x.xx mm ± 0.25 mm (x.xxx in ± 0.010 in.)

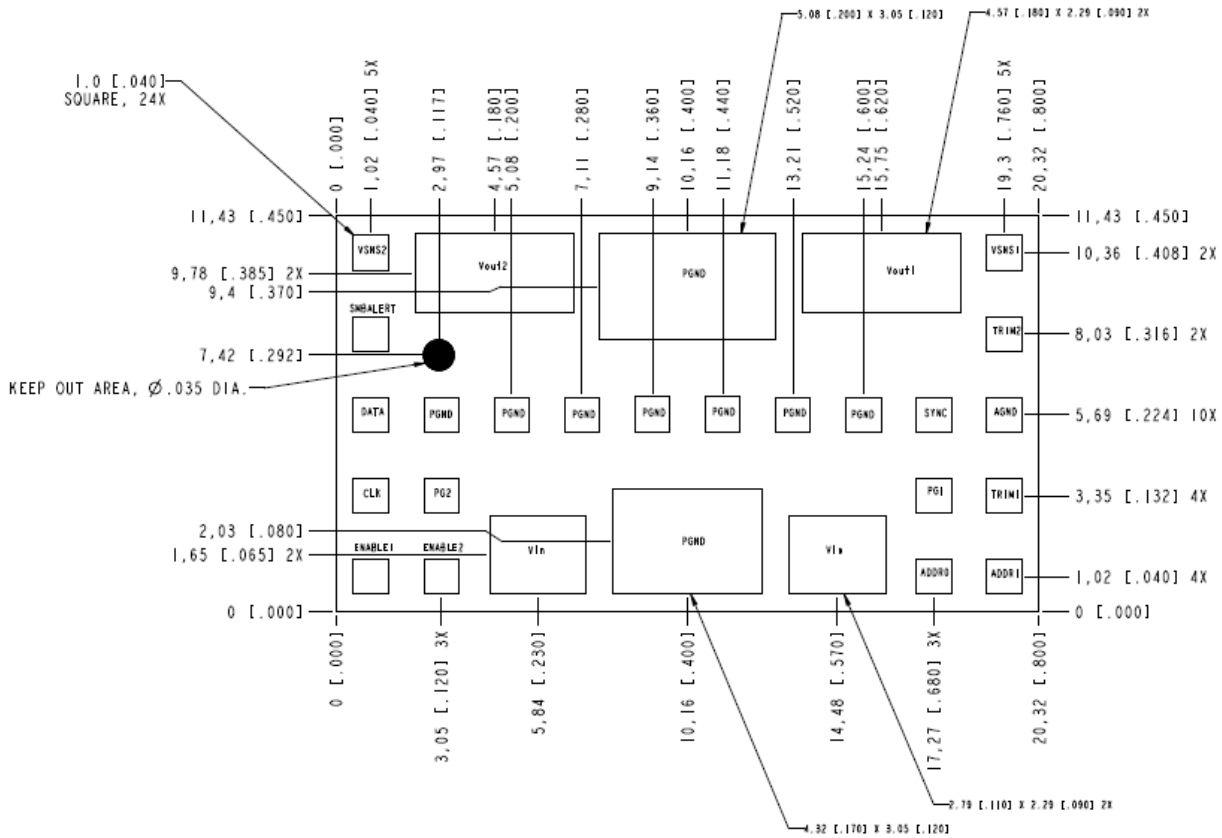

PIN	FUNCTION	PIN	FUNCTION
1	VSNS1	15	ADDR1
2	VOUT1	16	TRIM1
3	PGND	17	Sig_GND
4	VOUT2	18	TRIM2
5	VSNS2	19	SYNC
6	SMBALERT#	20	PGND
7	DATA	21	PGND
8	CLK	22	PGND
9	ENABLE1	23	PGND
10	ENABLE2	24	PGND
11	VIN	25	PGND
12	PGND	26	PGND
13	VIN	27	PGOOD2
14	ADDR0	28	PGOOD1

2 × 6A Digital Dual MicroDlynx™: Non-Isolated DC-DC Power Modules

4.5Vdc –14.4Vdc input; 0.51Vdc to 5.5Vdc output; 2 × 6A Output Current

Packaging Details

The 12V Digital Dual MicroDlynx™ 2 × 6A modules are supplied in tape & reel as standard. Modules are shipped in quantities of 200 modules per reel.

All Dimensions are in millimeters and (in inches).

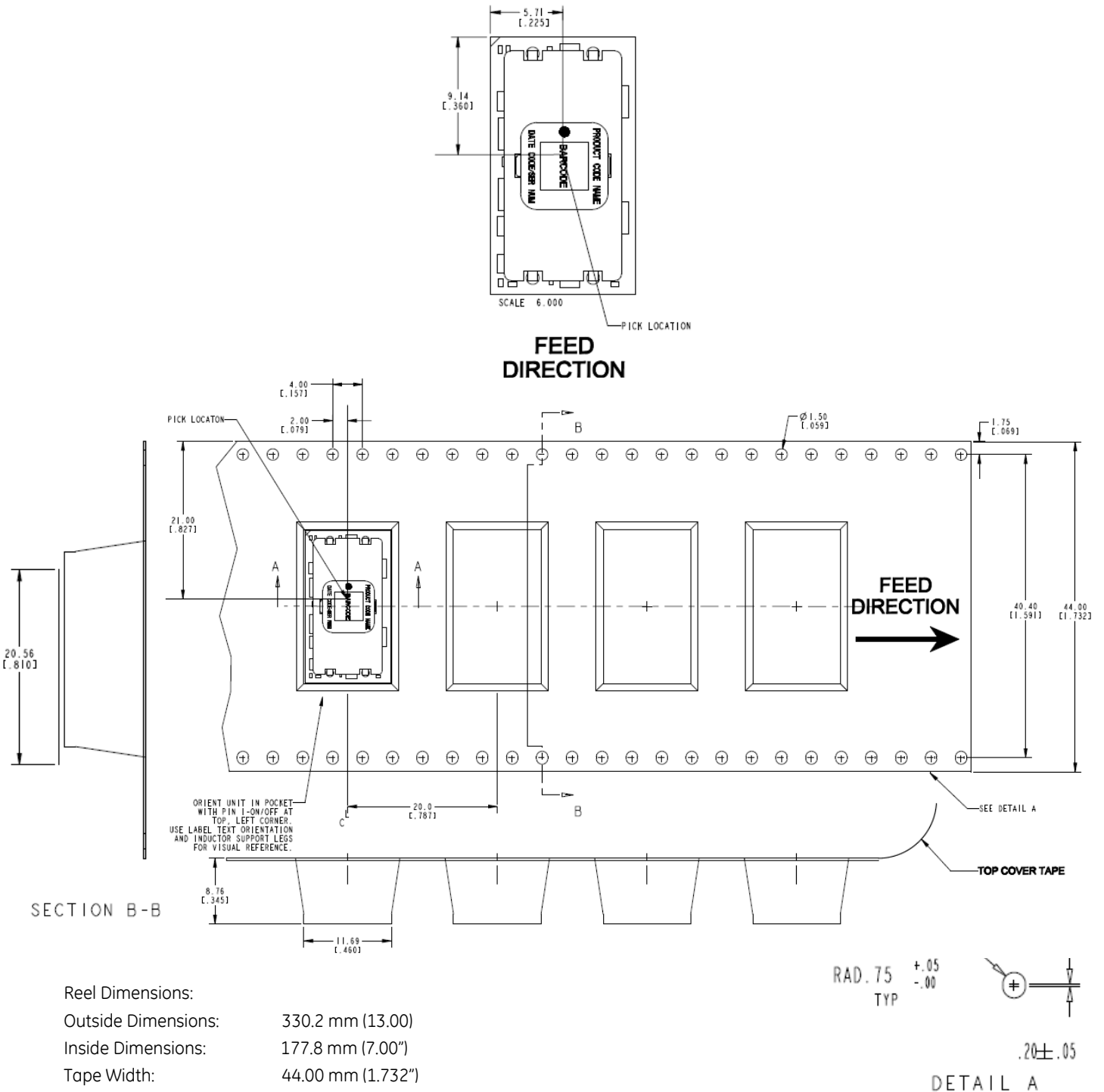

Reel Dimensions:	
Outside Dimensions:	330.2 mm (13.00)
Inside Dimensions:	177.8 mm (7.00")
Tape Width:	44.00 mm (1.732")

DETAIL A
 $.20 \pm .05$

2 × 6A Digital Dual MicroDlynx™: Non-Isolated DC-DC Power Modules

4.5Vdc –14.4Vdc input; 0.51Vdc to 5.5Vdc output; 2 × 6A Output Current

Surface Mount Information

Pick and Place

The 2 × 6A Digital Dual MicroDlynx™ modules use an open frame construction and are designed for a fully automated assembly process. The modules are fitted with a label designed to provide a large surface area for pick and place operations. The label meets all the requirements for surface mount processing, as well as safety standards, and is able to withstand reflow temperatures of up to 300°C. The label also carries product information such as product code, serial number and the location of manufacture.

Nozzle Recommendations

The module weight has been kept to a minimum by using open frame construction. Variables such as nozzle size, tip style, vacuum pressure and placement speed should be considered to optimize this process. The minimum recommended inside nozzle diameter for reliable operation is 3mm. The maximum nozzle outer diameter, which will safely fit within the allowable component spacing, is 7 mm.

Bottom Side / First Side Assembly

This module is not recommended for assembly on the bottom side of a customer board. If such an assembly is attempted, components may fall off the module during the second reflow process.

Lead Free Soldering

The modules are lead-free (Pb-free) and RoHS compliant and fully compatible in a Pb-free soldering process. Failure to observe the instructions below may result in the failure of or cause damage to the modules and can adversely affect long-term reliability.

Pb-free Reflow Profile

Power Systems will comply with J-STD-020 Rev. D (Moisture/Reflow Sensitivity Classification for Nonhermetic Solid State Surface Mount Devices) for both Pb-free solder profiles and MSL classification procedures. This standard provides a recommended forced-air-convection reflow profile based on the volume and thickness of the package (table 4-2). The suggested Pb-free solder paste is Sn/Ag/Cu (SAC). The recommended linear reflow profile using Sn/Ag/Cu solder is shown in Fig. 50. Soldering outside of the recommended profile requires testing to verify results and performance.

MSL Rating

The 2 × 6A Digital Dual MicroDlynx™ modules have a MSL rating of 3

Storage and Handling

The recommended storage environment and handling procedures for moisture-sensitive surface mount packages is detailed in J-STD-033 Rev. A (Handling, Packing, Shipping and Use of Moisture/Reflow Sensitive Surface Mount Devices). Moisture barrier bags (MBB) with desiccant are required for MSL ratings of 2 or greater. These sealed

packages should not be broken until time of use. Once the original package is broken, the floor life of the product at conditions of $\leq 30^{\circ}\text{C}$ and 60% relative humidity varies according to the MSL rating (see J-STD-033A). The shelf life for dry packed SMT packages will be a minimum of 12 months from the bag seal date, when stored at the following conditions: $< 40^{\circ}\text{C}$, $< 90\%$ relative humidity.

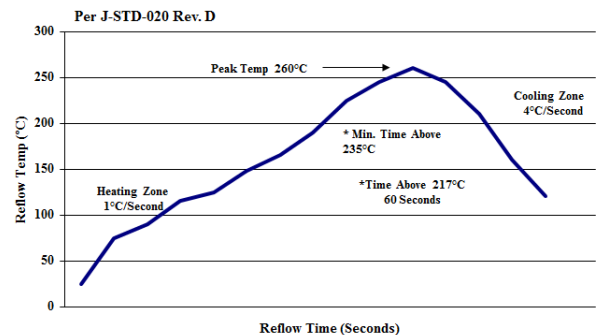

Figure 51. Recommended linear reflow profile using Sn/Ag/Cu solder.

Post Solder Cleaning and Drying Considerations

Post solder cleaning is usually the final circuit-board assembly process prior to electrical board testing. The result of inadequate cleaning and drying can affect both the reliability of a power module and the testability of the finished circuit-board assembly. For guidance on appropriate soldering, cleaning and drying procedures, refer to *Board Mounted Power Modules: Soldering and Cleaning* Application Note (AN04-001).

2 × 6A Digital Dual MicroDlynx™: Non-Isolated DC-DC Power Modules

4.5Vdc – 14.4Vdc input; 0.51Vdc to 5.5Vdc output; 2 × 6A Output Current

Ordering Information

Please contact your GE Sales Representative for pricing, availability and optional features.

Table 9. Device Codes

Device Code	Input Voltage Range	Output Voltage	Output Current	On/Off Logic	Sequencing	Comcodes
UDXS0606A0X3-SRZ	4.5 – 14.4Vdc	0.51 – 5.5 Vdc	6A x 2	Negative	No	150037588
UDXS0606A0X43-SRZ	4.5 – 14.4Vdc	0.51 – 5.5 Vdc	6A x 2	Positive	No	150037589
UDXS0606A0X3-SRDZ	4.5 – 14.4Vdc	0.51 – 5.5 Vdc	6A x 2	Negative	No	150037590

Table 10. Coding Scheme

Package Identifier	Family	Sequencing Option	Input Voltage	Output current	Output voltage	On/Off logic	Remote Sense	Options		ROHS Compliance
U	D	X	S	0606A0	X		3	-SR	-D	Z
P=Pico U=Micro M=Mega G=Giga	D=Dlynx Digital V = Dlynx Analog.	T=with EZ Sequence X=without sequencing	Special: 4.5 – 14V	2 × 6A	X = programmable output	4 = positive No entry = negative	3 = Remote Sense	S = Surface Mount R = Tape & Reel	D = 105C operating ambient, 40G operating shock as per MIL Std 810F	Z = ROHS6

GE Digital Non-Isolated DC-DC products use technology licensed from Power-One, protected by US patents: US20040246754, US2004090219A1, US2004093533A1, US2004123164A1, US2004123167A1, US2004178780A1, US2004179382A1, US20050200344, US20050223252, US2005289373A1, US20060061214, US2006015616A1, US20060174145, US20070226526, US20070234095, US20070240000, US20080052551, US20080072080, US20080186006, US6741099, US6788036, US6936999, US6949916, US7000125, US7049798, US7068021, US7080265, US7249267, US7266709, US7315156, US7372682, US7373527, US7394445, US7456617, US7459892, US7493504, US7526660.

Outside the US the Power-One licensed technology is protected by patents: AU3287379AA, AU3287437AA, AU3290643AA, AU3291357AA, CN10371856C, CN10452610C, CN10458656C, CN10459360C, CN10465848C, CN11069332A, CN11124619A, CN11346682A, CN1685299A, CN1685459A, CN1685582A, CN1685583A, CN1698023A, CN1802619A, EP1561156A1, EP1561268A2, EP1576710A1, EP1576711A1, EP1604254A4, EP1604264A4, EP1714369A2, EP1745536A4, EP1769382A4, EP1899789A2, EP1984801A2, W004044718A1, W004045042A3, W004045042C1, W004062061A1, W004062062A1, W004070780A3, W004084390A3, W004084391A3, W005079227A3, W005081771A3, W006019569A3, W02007001584A3, W02007094935A3

Contact Us

For more information, call us at

USA/Canada:

+1 877 546 3243, or +1 972 244 9288

Asia-Pacific:

+86.021.54279977*808

Europe, Middle-East and Africa:

+49.89.878067-280

India:

+91.80.28411633

www.gecriticalpower.com



GE Critical Power reserves the right to make changes to the product(s) or information contained herein without notice, and no liability is assumed as a result of their use or application. No rights under any patent accompany the sale of any such product(s) or information.

Данный компонент на территории Российской Федерации

Вы можете приобрести в компании MosChip.

Для оперативного оформления запроса Вам необходимо перейти по данной ссылке:

<http://moschip.ru/get-element>

Вы можете разместить у нас заказ для любого Вашего проекта, будь то серийное производство или разработка единичного прибора.

В нашем ассортименте представлены ведущие мировые производители активных и пассивных электронных компонентов.

Нашей специализацией является поставка электронной компонентной базы двойного назначения, продукции таких производителей как XILINX, Intel (ex.ALTERA), Vicor, Microchip, Texas Instruments, Analog Devices, Mini-Circuits, Amphenol, Glenair.

Сотрудничество с глобальными дистрибьюторами электронных компонентов, предоставляет возможность заказывать и получать с международных складов практически любой перечень компонентов в оптимальные для Вас сроки.

На всех этапах разработки и производства наши партнеры могут получить квалифицированную поддержку опытных инженеров.

Система менеджмента качества компании отвечает требованиям в соответствии с ГОСТ Р ИСО 9001, ГОСТ РВ 0015-002 и ЭС РД 009

Офис по работе с юридическими лицами:

105318, г.Москва, ул.Щербаковская д.3, офис 1107, 1118, ДЦ «Щербаковский»

Телефон: +7 495 668-12-70 (многоканальный)

Факс: +7 495 668-12-70 (доб.304)

E-mail: info@moschip.ru

Skype отдела продаж:

moschip.ru

moschip.ru_4

moschip.ru_6

moschip.ru_9