

8 WATT GaN MMIC POWER AMPLIFIER, 2 - 20 GHz

Typical Applications

The HMC1087 is ideal for:

- Test Instrumentation
- General Communications
- Radar

Features

- High Psat: +39 dBm
- Power Gain at Psat: +5.5 dB
- High Output IP3: +44 dBm
- Small Signal Gain: 11 dB
- Supply Voltage: +28 V @ 850 mA
- 50 Ohm Matched Input/Output
- Die Size: 2 x 4 x 0.1 mm

Functional Diagram

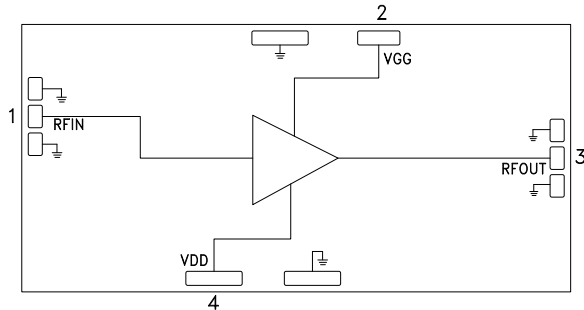

General Description

The HMC1087 is an 8W Gallium Nitride (GaN) MMIC Power Amplifier which operates between 2 and 20 GHz. The amplifier typically provides 11dB of small signal gain, +39 dBm of saturated output power, and +44 dBm output IP3 at +29 dBm output power per tone. The HMC1087 draws 850 mA quiescent current from a +28V DC supply. The RF I/Os are matched to 50 Ohms for ease of integration into Multi-Chip-Modules (MCMs). All electrical performance data was acquired with the die eutectically attached to 1.02 mm (40 mil) thick CuMo carrier with multiple 1.0 mil diameter ball bonds connecting the die to 50 Ohm transmission lines on alumina.

Electrical Specifications, $T_c = +25^\circ\text{C}$, $V_{dd} = +28\text{ V}$, $I_{dd} = 850\text{ mA}$ [1]

Parameter	Min.	Typ.	Max.	Min.	Typ.	Max.	Min.	Typ.	Max.	Units
Frequency Range	2 - 6			6 - 18			18 - 20			GHz
Small Signal Gain	10	11		10	12		10	12		dB
Gain Flatness		±0.5			±1.0			±0.5		dB
Gain Variation Over Temperature		0.012			0.016			0.024		dB/ °C
Input Return Loss		8			8			15		dB
Output Return Loss		10			12			12		dB
Output Power for 3 dB Compression (P3dB)		38			38			38		dBm
Power Gain for 3 dB compression (P3dB)		8.5			8.5			8		dB
Saturated Output Power (Psat)		39			40			39		dBm
Output Third Order Intercept (IP3) [2]		44			44			43.5		dBm
Power Added Efficiency		24			22			20		%
Quiescent Supply Current (I _{dd} @ V _{dd} = 28V)		850			850			850		mA

[1] Assumes eutectic attach of die to a 40mil CuMo carrier, and 25°C is maintained at the back of the carrier

[2] Measurement taken at P_{out} / tone = +29 dBm

**8 WATT GaN MMIC POWER AMPLIFIER,
2 - 20 GHz**

Gain and Return Loss

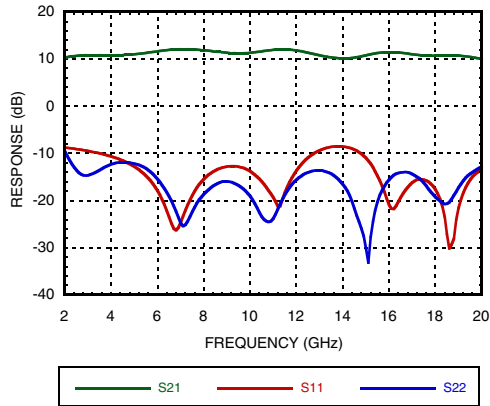

Gain vs. Temperature

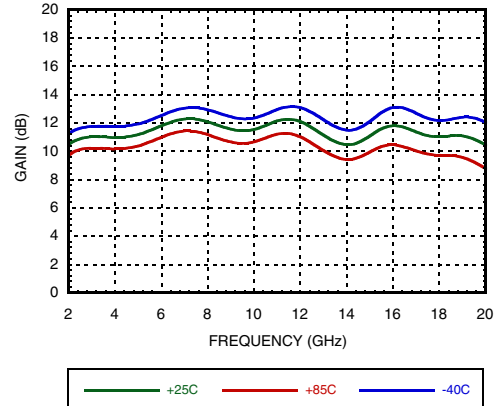

Input Return Loss vs. Temperature

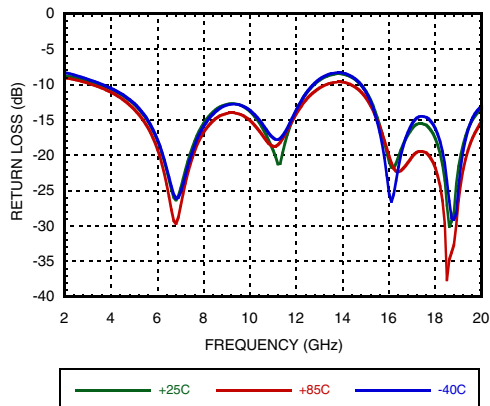

Output Return Loss vs. Temperature

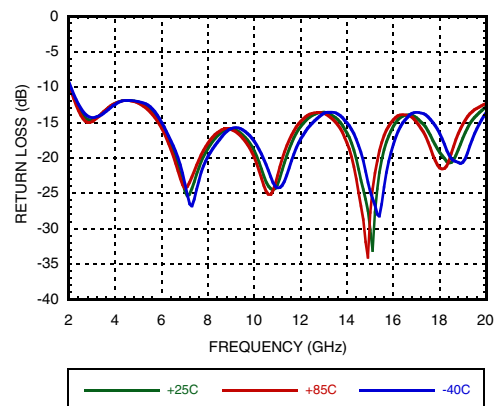

Gain vs. Bias

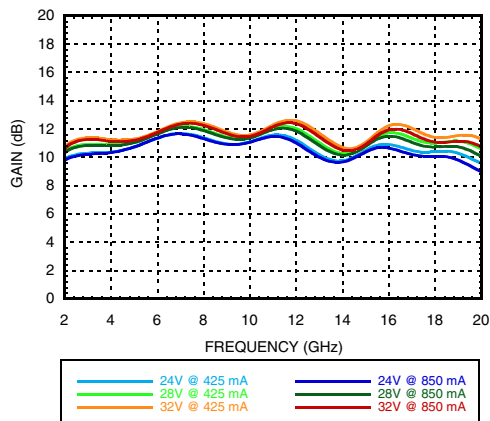

P3dB vs. Frequency

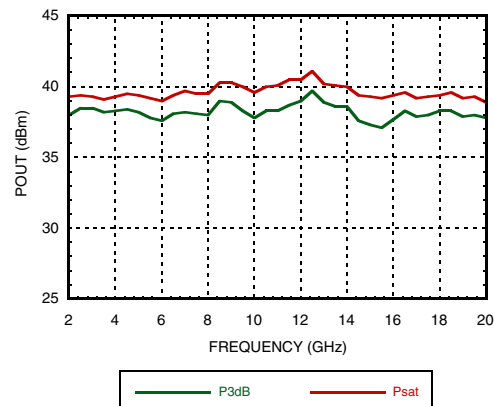

**8 WATT GaN MMIC POWER AMPLIFIER,
2 - 20 GHz**

AMPLIFIERS - LINEAR & POWER - CHIP

Power Gain vs. Frequency

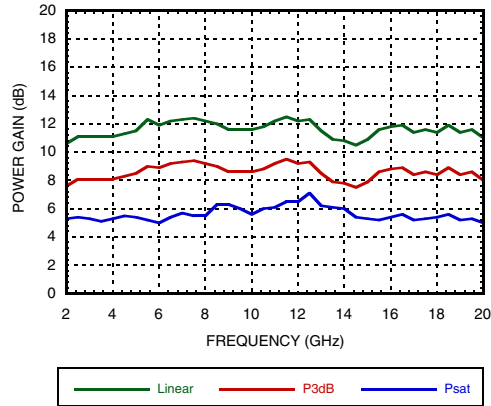

Power Added Efficiency vs. Pin

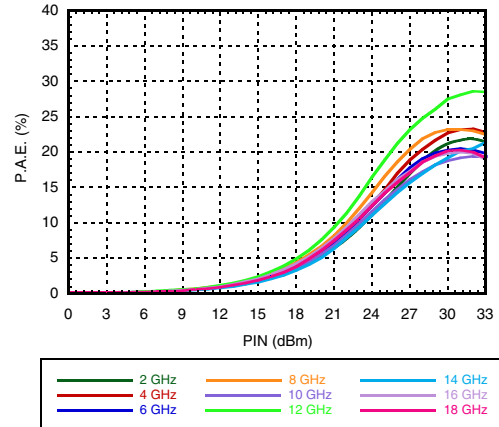

Pout vs. Pin

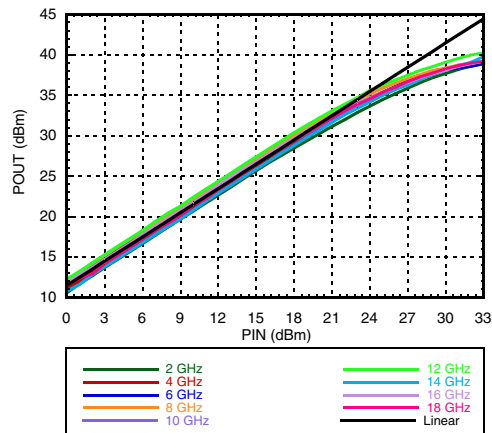

P3dB vs. Temperature

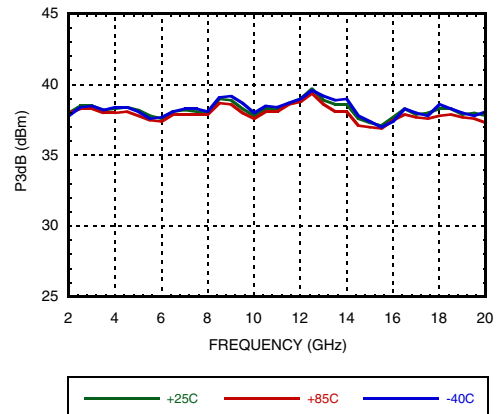

P3dB vs. DC Bias

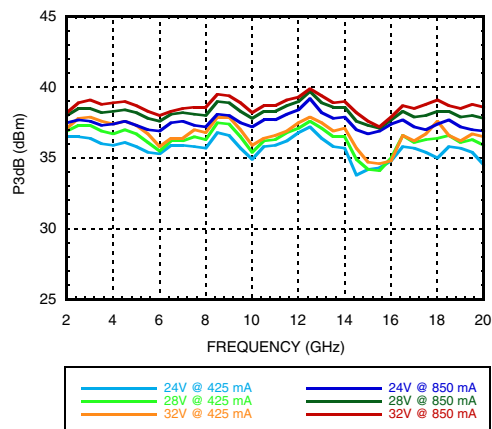

Psat vs. Temperature

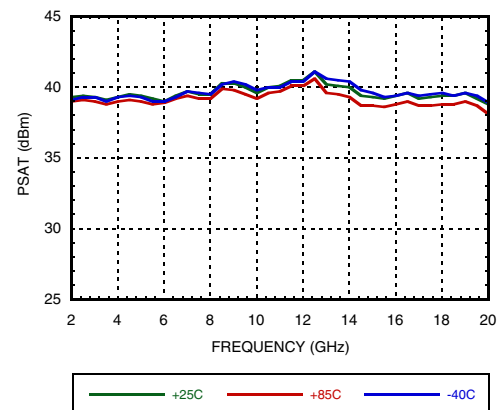

**8 WATT GaN MMIC POWER AMPLIFIER,
2 - 20 GHz**

Psat vs. DC Bias

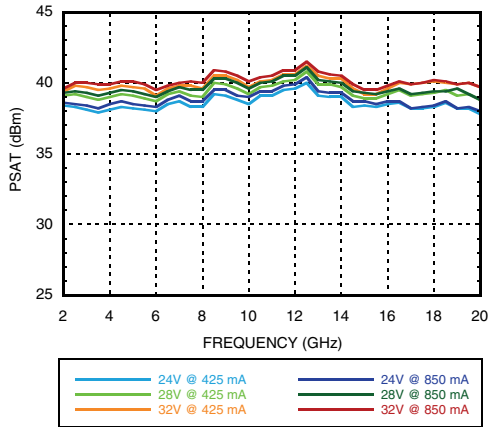

IDS vs. Pin

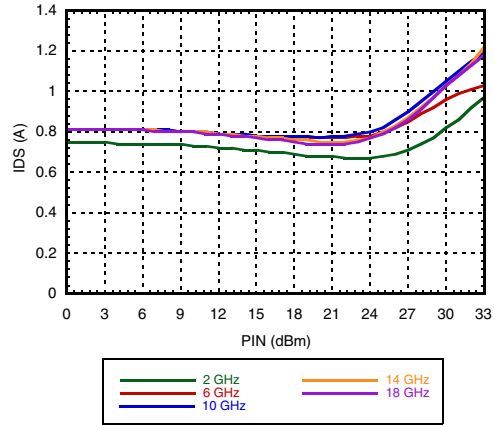

OIP3 vs. Frequency

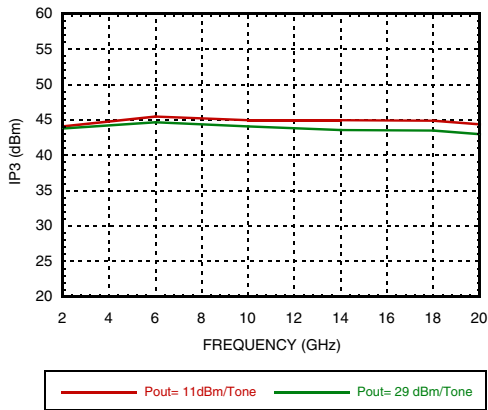

IM3 vs. Pout/Tone

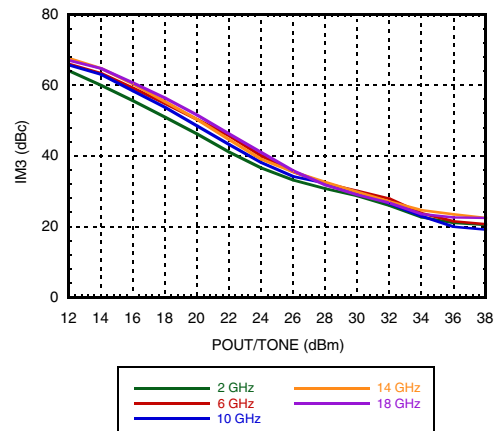

Reverse Isolation vs. Temperature

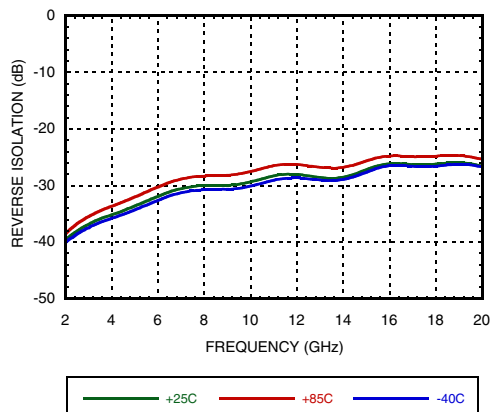

Power Dissipation vs. Pin

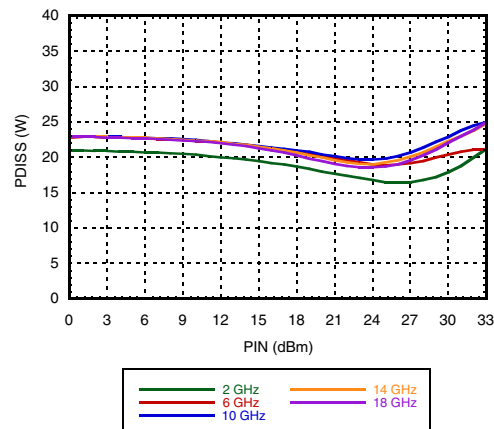

**8 WATT GaN MMIC POWER AMPLIFIER,
2 - 20 GHz**

Second Harmonic

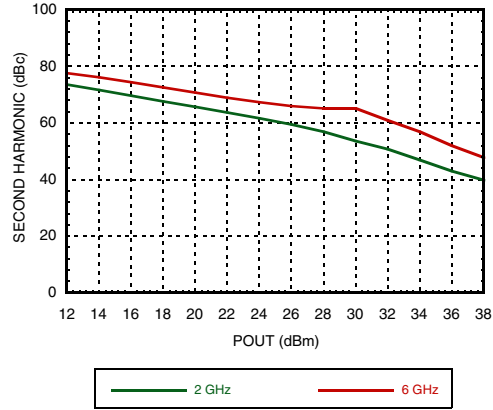

8 WATT GaN MMIC POWER AMPLIFIER, 2 - 20 GHz

Absolute Maximum Ratings^[1]

Drain Bias Voltage (Vdd)	+32V
Gate Bias Voltage (Vgg)	-8V to +0V
Maximum Forward Gate Current	4 mA
Maximum RF Input Power (RFIN)	34 dBm
Maximum Junction Temperature (Tj)	225 °C
Maximum Pdiss (T=85°C) (Derate 236 mW/°C above 85°C)	33 W
Thermal Resistance ^[2]	4.24 °C/W
Maximum VSWR ^[3]	4:1
Storage Temperature	-55 to +150 °C
Operating Temperature	-40 to +85 °C

Typical Supply Current vs. Vdd

Vdd (V)	Idd (mA)
+28.0	850



**ELECTROSTATIC SENSITIVE DEVICE
OBSERVE HANDLING PRECAUTIONS**

[1] Operation outside parameter ranges above can cause permanent damage to the device. These are maximum stress ratings only. Continuous operation of the device at these conditions is not implied.

[2] Assumes 0.5mil AuSn die attach to a 40mil CuMo Carrier with 85°C at the back of the carrier.

[3] Restricted by maximum power dissipation

Outline Drawing

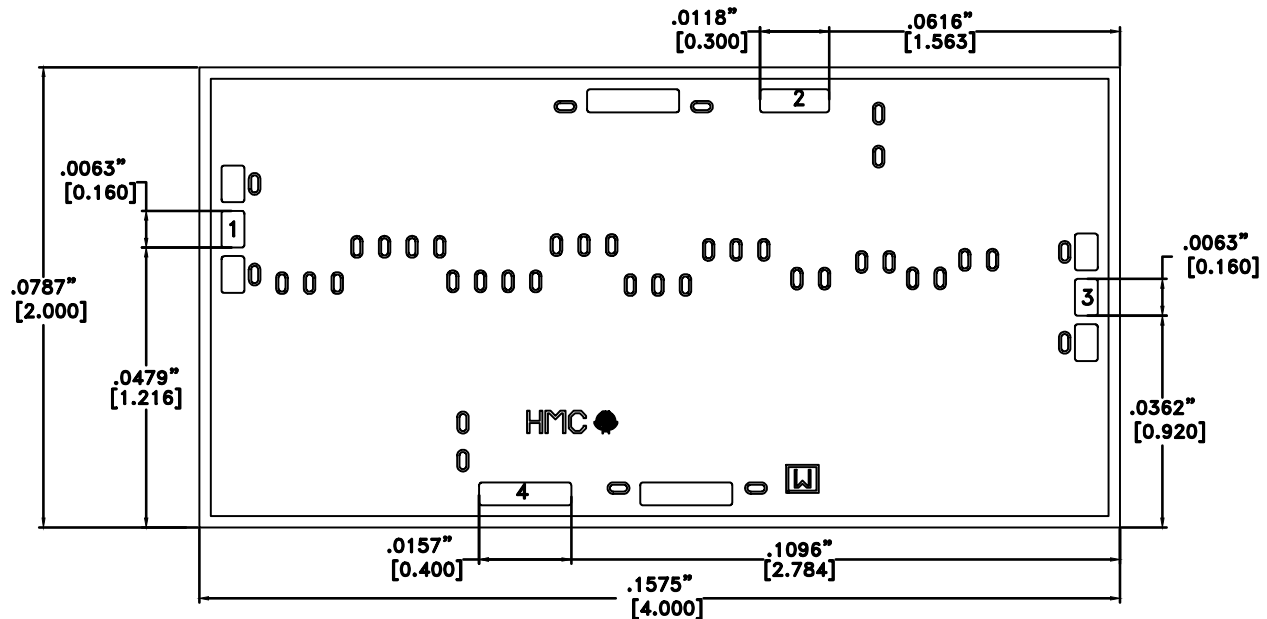

NOTES:

1. ALL DIMENSIONS ARE IN INCHES [MM]
2. DIE THICKNESS IS .004"
3. TYPICAL BOND PAD IS .004" SQUARE
4. BACKSIDE METALLIZATION: GOLD
5. BOND PAD METALLIZATION: GOLD
6. BACKSIDE METAL IS GROUND.
7. CONNECTION NOT REQUIRED FOR UNLABELED BOND PADS.
8. OVERALL DIE SIZE ± .002

Die Packaging Information^[1]

Standard	Alternate
GP-1 (Gel Pack)	[2]

[1] Refer to the "Packaging Information" section for die packaging dimensions.

[2] For alternate packaging information contact Hittite Microwave Corporation.

8 WATT GaN MMIC POWER AMPLIFIER, 2 - 20 GHz

Pad Descriptions

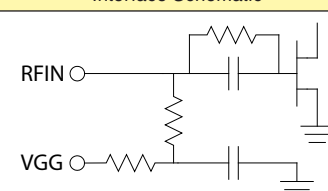
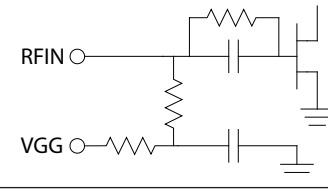
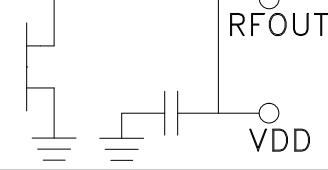
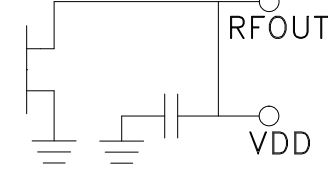
Pad Number	Function	Description	Interface Schematic
1	RFIN	This pad is DC coupled and is matched to 50 Ohms. External blocking capacitor is required	
2	VGG	Gate Bias (Internally isolated from RFIN)	
3	RFOUT	This pad is DC coupled and is matched to 50 Ohms. External blocking capacitor is required.	
4	VDD	Drain Bias (Internally isolated from RFOUT)	
Die Bottom	GND	Die bottom must be connected to RF/DC ground.	

**8 WATT GaN MMIC POWER AMPLIFIER,
2 - 20 GHz**

Application Circuit

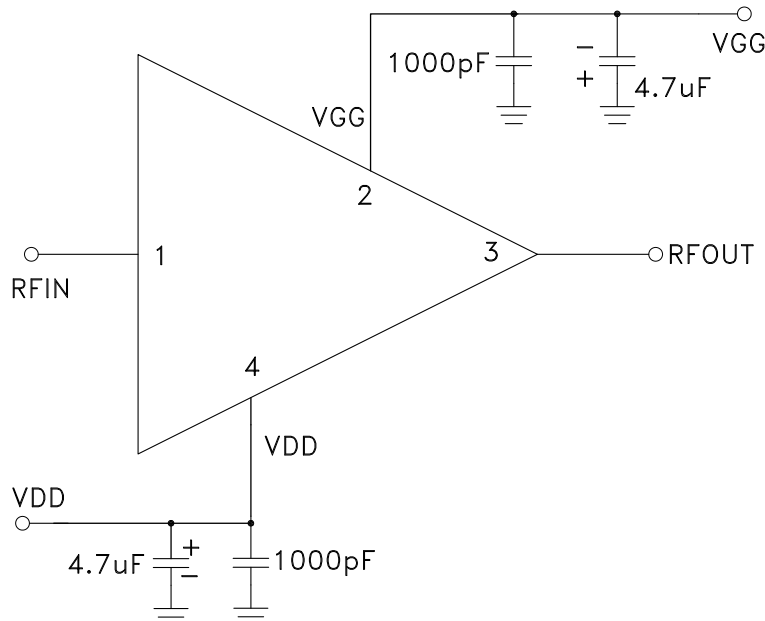

Assembly Diagram

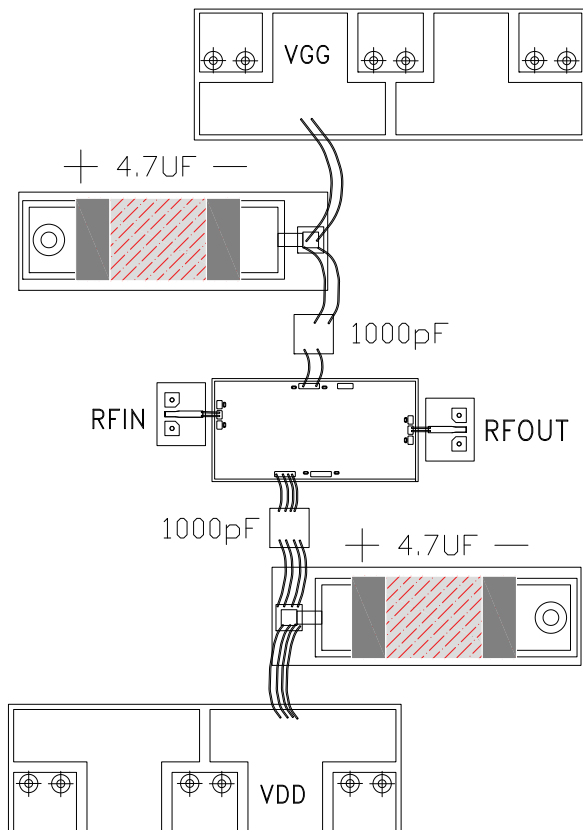

8 WATT GaN MMIC POWER AMPLIFIER, 2 - 20 GHz

Mounting & Bonding Techniques for GaN MMICs

The die should be eutectically attached directly to the ground plane (see HMC general Handling, Mounting, Bonding Note).

50 Ohm Microstrip transmission lines on 0.127mm (5 mil) thick alumina thin film substrates are recommended for bringing RF to and from the chip (Figure 1). If 0.254mm (10 mil) thick alumina thin film substrates must be used, the die should be raised 0.150mm (6 mils) so that the surface of the die is coplanar with the surface of the substrate. One way to accomplish this is to attach the 0.102mm (4 mil) thick die to a copper tungsten or CuMo heat spreader which is then attached to the thermally conductive ground plane (Figure 2).

Microstrip substrates should be placed as close to the die as possible in order to minimize bond wire length. Typical die-to-substrate spacing is 0.076mm to 0.152 mm (3 to 6 mils).

Handling Precautions

Follow these precautions to avoid permanent damage.

Storage: All bare die are placed in either Waffle or Gel based ESD protective containers, and then sealed in an ESD protective bag for shipment. Once the sealed ESD protective bag has been opened, all die should be stored in a dry nitrogen environment.

Cleanliness: Handle the chips in a clean environment. DO NOT attempt to clean the chip using liquid cleaning systems.

Static Sensitivity: Follow ESD precautions to protect against ESD strikes.

Transients: Suppress instrument and bias supply transients while bias is applied. Use shielded signal and bias cables to minimize inductive pick-up.

Die placement: A heated vacuum collet (180°C) is the preferred method of pick up. Ensure that the area of vacuum contact on the die is minimized to prevent cracking under differential pressure. All air bridges (if applicable) must be avoided during placement. Minimize impact forces applied to the die during auto-placement.

Mounting

The chip is back-metallized with a minimum of 5 microns of gold and is the RF ground and thermal interface. It is recommended that the chip be die mounted with AuSn eutectic preforms. The mounting surface should be clean and flat.

Eutectic Reflow Process: An 80/20 gold tin 0.5mil (13um) thick preform is recommended with a work surface temperature of 280°C. Limit exposure to temperatures above 300°C to 30 seconds maximum. A die bonder or furnace with 95% N₂ / 5% H₂ reducing atmosphere should be used. No organic flux should be used. Coefficient of thermal expansion matching is critical for long term reliability.

Die Attach Inspection: X-ray or acoustic scan is recommended.

Wire Bonding

Thermosonic ball or wedge bonding is the preferred interconnect technique. Gold wire must be used in a diameter appropriate for the pad size and number of bonds applied. Force, time and ultrasonics are critical parameters: optimize for a repeatable, high bond pull strength. Limit the die bond pad surface temperature to 200°C maximum.

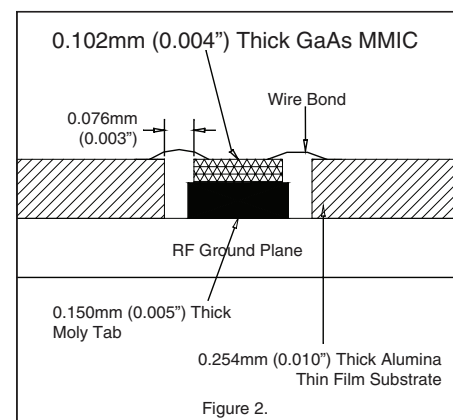
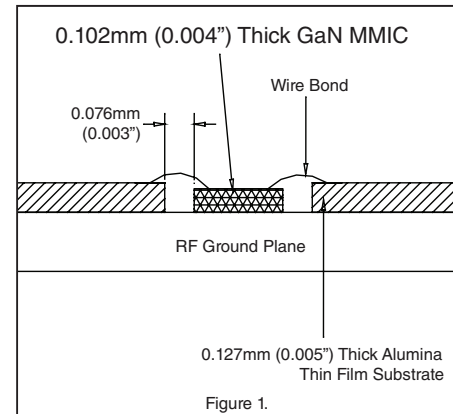

**8 WATT GaN MMIC POWER AMPLIFIER,
2 - 20 GHz**

Notes:

Данный компонент на территории Российской Федерации

Вы можете приобрести в компании MosChip.

Для оперативного оформления запроса Вам необходимо перейти по данной ссылке:

<http://moschip.ru/get-element>

Вы можете разместить у нас заказ для любого Вашего проекта, будь то серийное производство или разработка единичного прибора.

В нашем ассортименте представлены ведущие мировые производители активных и пассивных электронных компонентов.

Нашей специализацией является поставка электронной компонентной базы двойного назначения, продукции таких производителей как XILINX, Intel (ex.ALTERA), Vicor, Microchip, Texas Instruments, Analog Devices, Mini-Circuits, Amphenol, Glenair.

Сотрудничество с глобальными дистрибьюторами электронных компонентов, предоставляет возможность заказывать и получать с международных складов практически любой перечень компонентов в оптимальные для Вас сроки.

На всех этапах разработки и производства наши партнеры могут получить квалифицированную поддержку опытных инженеров.

Система менеджмента качества компании отвечает требованиям в соответствии с ГОСТ Р ИСО 9001, ГОСТ РВ 0015-002 и ЭС РД 009

Офис по работе с юридическими лицами:

105318, г.Москва, ул.Щербаковская д.3, офис 1107, 1118, ДЦ «Щербаковский»

Телефон: +7 495 668-12-70 (многоканальный)

Факс: +7 495 668-12-70 (доб.304)

E-mail: info@moschip.ru

Skype отдела продаж:

moschip.ru

moschip.ru_4

moschip.ru_6

moschip.ru_9