



Features

- Single-turn (3851 and 3852)
- Linear and audio tapers
- 3-3/4-turn (3856)
- Wide resistance range
- Minimal depth package
- Good resolution

3851/3852/3856 - 3/4 " Diameter Panel Control

Initial Electrical Characteristics¹

	3851 Conductive Plastic Element	3852/3856 Cermet Element
Standard Resistance Range		
Linear Tapers (A, B, E, and H).....	1 K to 1 megohm.....	100 ohms to 1 megohm
Audio Tapers (C, D, F, and G).....	1 K to 1 megohm.....	1 K ohms to 1 megohm
Total Resistance Tolerance.....	±10 % or ±20 %.....	±5 % or ±10 %
Independent Linearity.....	±10 %.....	(A & H tapers) ±5 %
Absolute Minimum Resistance.....	2 ohms maximum.....	2 ohms maximum
Effective Electrical Angle.....	250 ° ±5 °.....	250 ° ±5 °
Contact Resistance Variation.....	±1 %.....	±3 % of total resistance or 3 ohms (whichever is greater)
Dielectric Withstanding Voltage (MIL-STD-202, Method 301)		
Sea Level.....	900 VAC minimum.....	900 VAC minimum
70,000 Feet.....	350 VAC minimum.....	350 VAC minimum
Insulation Resistance (500 VDC).....	1,000 megohms minimum.....	1,000 megohms minimum
Power Rating (Voltage Limited By Power Dissipation or 350 VAC, Whichever Is Less)		
+70 °C.....	(Linear tapers) 1 watt..... (Audio tapers) 0.5 watt.....	(Linear tapers) 2 watts (Audio tapers) 1 watt
+125 °C.....	0 watt.....	
+150 °C.....	0 watt.....	0 watt
Theoretical Resolution.....	Essentially infinite.....	Essentially infinite

Environmental Characteristics¹

Operating Temperature Range.....	-1 °C to +125 °C.....	-1 °C to +125 °C
Storage Temperature Range.....	-65 °C to +125 °C.....	-65 °C to +150 °C
Temperature Coefficient Over		
Storage Temperature Range.....	±1,000 ppm/°C.....	±150 ppm/°C
Vibration.....	20 G.....	20 G
Total Resistance Shift.....	±2 % maximum.....	±2 % maximum
Voltage Ratio Shift.....	±5 % maximum.....	±6 % maximum
Shock.....	100 G.....	100 G
Total Resistance Shift.....	±2 % maximum.....	±2 % maximum
Voltage Ratio Shift.....	±5 % maximum.....	±6 % maximum
Load Life.....	1,000 hours.....	1,000 hours
Total Resistance Shift.....	±10 % maximum.....	±3 % maximum
Rotational Life (No Load).....	100,000 cycles.....	50,000 cycles
Total Resistance Shift.....	±15 % TRS maximum.....	±5 % or 5 ohms TRS whichever is greater
Contact Resistance Variation.....	±3 %.....	±3 %
Moisture Resistance (MIL-STD-202, Method 103, Condition B)		
Total Resistance Shift.....	±10 % maximum.....	±2 % maximum
IP Rating.....	IP 40.....	IP 40

Mechanical Characteristics¹

Stop Strength	
3851 & 3852.....	56.5 N-cm (5 lb.-in.)
3856.....	Continuous turn
Mechanical Angle.....	280 ° ±5 ° / 3856 – 1350 ° ±50 °
Torque (Starting and Running).....	A & B bushings 0.35 to 4.23 N-cm (0.05 to 6.0 oz.-in.) C & E bushings 0.21 to 4.23 N-cm (0.3 to 6.0 oz.-in.) 3856 – 0.11 to 2.12 N-cm (0.15 to 3.0 oz.-in.)
Mounting (Torque on Bushing).....	1.7-2.0 N-m (15-18 lb.-in.) maximum
Weight (Single Section).....	30 grams maximum
Terminals.....	Printed circuit terminals or solder lugs
Soldering Condition.....	Recommended hand soldering using Sn95/Ag5 no clean solder, 0.025 " wire diameter. Maximum temperature 399 °C (750 °F) for 3 seconds. No wash process to be used with no clean flux. Part can be wave soldered at 260 °C (500 °F) for 5 seconds, no wash process with no clean flux.
Marking.....	Manufacturer's trademark, wiring diagram, resistance, date code, and part number
Ganging (Multiple Section Potentiometers).....	1 cup maximum
Hardware.....	One lockwasher and one mounting nut is shipped with each potentiometer, except where noted in the part number.

¹ At room ambient: +25 °C nominal and 50 % relative humidity nominal, except as noted.

*RoHS Directive 2002/95/EC Jan. 27, 2003 including annex and RoHS Recast 2011/65/EU June 8, 2011.
Specifications are subject to change without notice.
The device characteristics and parameters in this data sheet can and do vary in different applications and actual device performance may vary over time.
Users should verify actual device performance in their specific applications.

3851/3852/3856 - 3/4" Diameter Panel Control

BOURNS®

Product Dimensions

3851A/3852A



3851B/3852B

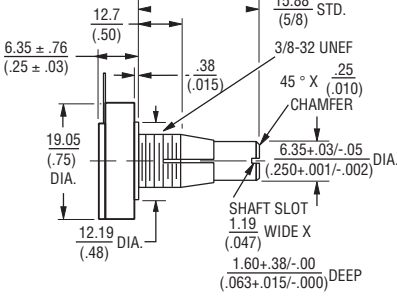

Terminal Configuration

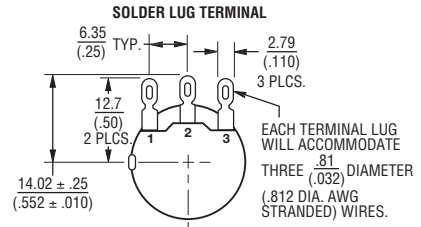

3851C/3852C



3851E/3852E

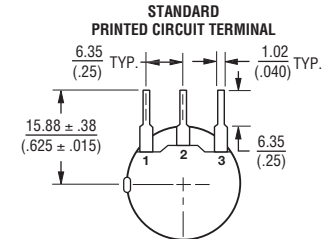
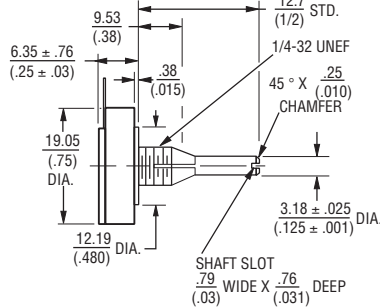

3851/3852/3856

A, B & H BUSHINGS

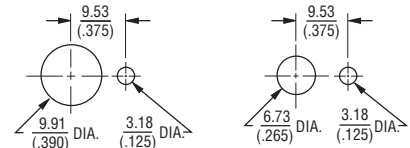

3856A

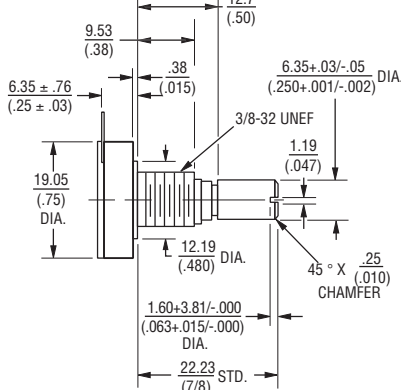

3856H

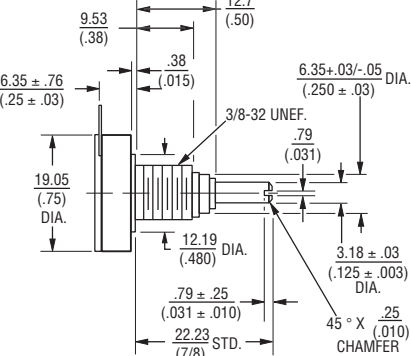

Shaft End Detail 3850 Family

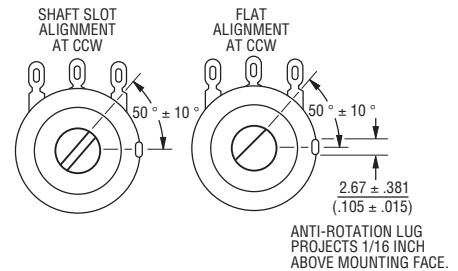

TOLERANCES EXCEPT AS NOTED:
DECIMALS: .XXX ± .127 .XX ± .38 (.005),
FRACTIONS: ± 1/64
ANGLE: ± 3%

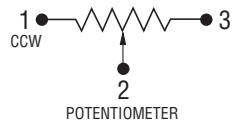

DIMENSIONS: MM (INCHES)

Specifications are subject to change without notice.
The device characteristics and parameters in this data sheet can and do vary in different applications and actual device performance may vary over time.
Users should verify actual device performance in their specific applications.

3851/3852/3856 - 3/4 " Diameter Panel Control

BOURNS®

How To Order

3852 A - 28 2 - 103 A L

SHAFT TYPE (FMS) & DIAMETER		AVAILABLE ONLY IN	
		MODELS	BUSHINGS
12	3/8 " (9.53 mm) L X 1/8 " (3.18 mm) D	3851, 3852	C
16	1/2 " (12.7 mm) L x 1/4 " (6.35 mm) D	3851, 3852	A
16	1/2 " (12.7 mm) L x 1/8 " (3.18 mm) D	3851, 3852	C, E
20	5/8 " (15.88 mm) L X 1/4 " (6.35 mm) D	3851, 3852	A, B
28	7/8 " (22.20 mm) L X 1/4 " (6.35 mm) D	3851, 3852 3856	A, B A
28	7/8 " (22.20 mm) L X 1/8 " (3.18 mm) D	3851, 3852 3856	C, E H

Consult factory for lengths not shown.

BUSHING	APPLICABLE MODELS
A Plain 3/8 " (9.53 mm) D x 3/8 " (9.53 mm) L	3851, 3852, 3856
B Locking 3/8 " (9.53 mm) D x 1/2 " (12.7 mm) L	3851, 3852
C Plain 1/4 " (6.35 mm) D x 1/4 " (6.35 mm) L	3851, 3852
E Locking 1/4 " (6.35 mm) D x 1/2 " (12.7 mm) L	3851, 3852
H Plain 3/8 " (9.53 mm) D x 3/8 " (9.53 mm) L	3856 (3.18 mm D Shaft)

MODEL	
3851	3/4 " (19.05 mm) D Single-Turn C.P.
3852	3/4 " (19.05 mm) D Single-Turn Cermet
3856	3/4 " (19.05 mm) D 3-3/4-Turn Cermet

Boldface features are Bourns standard options.
All others are available with higher minimum order quantities.

TERMINAL STYLE AND SHAFT TYPE	
1	Solder Lugs, Plain End
2	Solder Lugs, Slotted End
3	Solder Lugs, Flatted Shaft
5	PC Pins, Plain End
6	PC Pins, Slotted End
7	PC Pins, Flatted Shaft

RESISTANCE CODE/VALUE (IN OHMS) Model 3851	
(102)	1 K
(252)	2.5 K
(502)	5 K
(103)	10 K
(253)	25 K
(503)	50 K
(104)	100 K
(254)	250 K
(504)	500 K
(105)	1 M
Models 3852/3856	
(101)	100
(251)	250
(501)	500
(102)	1 K
(252)	2.5 K
(502)	5 K
(103)	10 K
(253)	25 K
(503)	50 K
(104)	100 K
(254)	250 K
(504)	500 K
(105)	1 M

RoHS IDENTIFIER	
L	Compliant

ELEMENT TAPER/TOLERANCE	APPLICABLE MODELS
A Linear ±10 %	3852, 3856
B Linear ±20 %	3851
C Audio CW ±10 %	3852, 3856
D Audio CW ±20 %	3851
E Linear ±10 %	3851
F Audio CCW ±10 %	3852, 3856
G Audio CCW ±20 %	3851
H Linear ±5 %	3852, 3856

REV. 03/15

Specifications are subject to change without notice.

The device characteristics and parameters in this data sheet can and do vary in different applications and actual device performance may vary over time. Users should verify actual device performance in their specific applications.

Данный компонент на территории Российской Федерации

Вы можете приобрести в компании MosChip.

Для оперативного оформления запроса Вам необходимо перейти по данной ссылке:

<http://moschip.ru/get-element>

Вы можете разместить у нас заказ для любого Вашего проекта, будь то серийное производство или разработка единичного прибора.

В нашем ассортименте представлены ведущие мировые производители активных и пассивных электронных компонентов.

Нашей специализацией является поставка электронной компонентной базы двойного назначения, продукции таких производителей как XILINX, Intel (ex.ALTERA), Vicor, Microchip, Texas Instruments, Analog Devices, Mini-Circuits, Amphenol, Glenair.

Сотрудничество с глобальными дистрибьюторами электронных компонентов, предоставляет возможность заказывать и получать с международных складов практически любой перечень компонентов в оптимальные для Вас сроки.

На всех этапах разработки и производства наши партнеры могут получить квалифицированную поддержку опытных инженеров.

Система менеджмента качества компании отвечает требованиям в соответствии с ГОСТ Р ИСО 9001, ГОСТ РВ 0015-002 и ЭС РД 009

Офис по работе с юридическими лицами:

105318, г.Москва, ул.Щербаковская д.3, офис 1107, 1118, ДЦ «Щербаковский»

Телефон: +7 495 668-12-70 (многоканальный)

Факс: +7 495 668-12-70 (доб.304)

E-mail: info@moschip.ru

Skype отдела продаж:

moschip.ru

moschip.ru_4

moschip.ru_6

moschip.ru_9