

1SMB5.0A  
THRU  
1SMB170A



**SURFACE MOUNT  
UNI-DIRECTIONAL  
GLASS PASSIVATED JUNCTION  
SILICON TRANSIENT  
VOLTAGE SUPPRESSOR  
600 WATTS, 5.0 THRU 170 VOLTS**



www.centrasemi.com

**DESCRIPTION:**

The CENTRAL SEMICONDUCTOR 1SMB5.0A Series types are Surface Mount Uni-Directional Glass Passivated Junction Transient Voltage Suppressors designed to protect voltage sensitive components from high voltage transients.

**THIS DEVICE IS MANUFACTURED WITH A GLASS PASSIVATED CHIP FOR OPTIMUM RELIABILITY.**

Note: For Bi-directional devices, please refer to the 1SMB5.0CA Series data sheet.

**MARKING CODE: SEE ELECTRICAL CHARACTERISTICS TABLE**

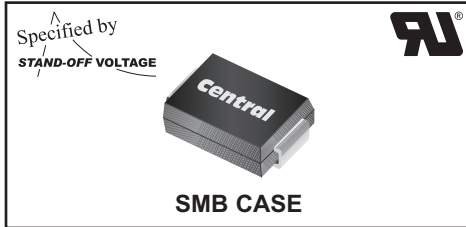

• This series is UL listed, UL file number E130224

**MAXIMUM RATINGS:** ( $T_A=25^\circ\text{C}$  unless otherwise noted)

Peak Power Dissipation (Note 1)  
Peak Forward Surge Current (JEDEC Method)  
Operating and Storage Junction Temperature

**SYMBOL**

$P_{DM}$  600  
 $I_{FSM}$  100  
 $T_J, T_{stg}$  -65 to +150

**UNITS**

W  
A  
 $^\circ\text{C}$

**ELECTRICAL CHARACTERISTICS:** ( $T_A=25^\circ\text{C}$  unless otherwise noted)

TYPE	REVERSE STAND-OFF VOLTAGE	BREAKDOWN VOLTAGE		TEST CURRENT	MAXIMUM REVERSE LEAKAGE CURRENT @ $V_{RWM}$	MAXIMUM CLAMPING VOLTAGE @ $I_{pp}$	PEAK PULSE CURRENT (Note 1)	MARKING CODE
		$V_{BR}$ @ $I_T$						
	$V_{RWM}$ (V)	MIN (V)	MAX (V)	$I_T$ (mA)	$I_R$ ( $\mu\text{A}$ )	$V_C$ (V)	$I_{pp}$ (A)	
1SMB5.0A	5.0	6.40	7.25	10	800	9.2	65.2	CKE
1SMB6.0A	6.0	6.67	7.67	10	800	10.3	58.3	CKG
1SMB6.5A	6.5	7.22	8.30	10	500	11.2	53.6	CKK
1SMB7.0A	7.0	7.78	8.95	10	200	12	50	CKM
1SMB7.5A	7.5	8.33	9.58	1.0	100	12.9	46.5	CKP
1SMB8.0A	8.0	8.89	10.23	1.0	50	13.6	44.1	CKR
1SMB8.5A	8.5	9.44	10.82	1.0	10	14.4	41.7	CKT
1SMB9.0A	9.0	10	11.5	1.0	5.0	15.4	39	CKV
1SMB10A	10	11.1	12.8	1.0	5.0	17	35.3	CKX
1SMB11A	11	12.2	14	1.0	5.0	18.2	33	CKZ
1SMB12A	12	13.3	15.3	1.0	5.0	19.9	30.2	CLE
1SMB13A	13	14.4	16.5	1.0	5.0	21.5	27.9	CLG
1SMB14A	14	15.6	17.9	1.0	5.0	23.2	25.8	CLK
1SMB15A	15	16.7	19.2	1.0	5.0	24.4	24	CLM
1SMB16A	16	17.8	20.5	1.0	5.0	26	23.1	CLP
1SMB17A	17	18.9	21.7	1.0	5.0	27.6	21.7	CLR
1SMB18A	18	20	23.3	1.0	5.0	29.2	20.5	CLT
1SMB20A	20	22.2	25.5	1.0	5.0	32.4	18.5	CLV
1SMB22A	22	24.4	28	1.0	5.0	35.5	16.9	CLX
1SMB24A	24	26.7	30.7	1.0	5.0	38.9	15.4	CLZ
1SMB26A	26	28.9	33.2	1.0	5.0	42.1	14.2	CME
1SMB28A	28	31.1	35.8	1.0	5.0	45.4	13.2	CMG
1SMB30A	30	33.3	38.3	1.0	5.0	48.4	12.4	CMK

Notes: (1) Non-repetitive 10x1,000 $\mu\text{s}$  pulse.

R4 (20-November 2009)

**1SMB5.0A  
THRU  
1SMB170A**

**SURFACE MOUNT  
UNI-DIRECTIONAL  
GLASS PASSIVATED JUNCTION  
SILICON TRANSIENT  
VOLTAGE SUPPRESSOR  
600 WATTS, 5.0 THRU 170 VOLTS**



**ELECTRICAL CHARACTERISTICS - Continued:**

TYPE	REVERSE STAND-OFF VOLTAGE	BREAKDOWN VOLTAGE		TEST CURRENT	MAXIMUM REVERSE LEAKAGE CURRENT @ $V_{RWM}$	MAXIMUM CLAMPING VOLTAGE @ $I_{PP}$	PEAK PULSE CURRENT (Note 1)	MARKING CODE
		$V_{BR}$ @ $I_T$						
	$V_{RWM}$ (V)	MIN (V)	MAX (V)	$I_T$ (mA)	$I_R$ ( $\mu$ A)	$V_C$ (V)	$I_{PP}$ (A)	
1SMB33A	33	36.7	42.2	1.0	5.0	53.3	11.3	CMM
1SMB36A	36	40	46	1.0	5.0	58.1	10.3	CMP
1SMB40A	40	44.4	51.1	1.0	5.0	64.5	9.3	CMR
1SMB43A	43	47.8	54.9	1.0	5.0	69.4	8.6	CMT
1SMB45A	45	50	57.5	1.0	5.0	72.7	8.3	CMV
1SMB48A	48	53.3	61.3	1.0	5.0	77.4	7.7	CMX
1SMB51A	51	56.7	65.2	1.0	5.0	82.4	7.3	CMZ
1SMB54A	54	60	69	1.0	5.0	87.1	6.9	CNE
1SMB58A	58	64.4	74.1	1.0	5.0	93.6	6.4	CNG
1SMB60A	60	66.7	76.7	1.0	5.0	96.8	6.2	CNK
1SMB64A	64	71.1	81.8	1.0	5.0	103	5.8	CNM
1SMB70A	70	77.8	89.5	1.0	5.0	113	5.3	CNP
1SMB75A	75	83.3	95.8	1.0	5.0	121	4.9	CNR
1SMB78A	78	86.7	99.7	1.0	5.0	126	4.7	CNT
1SMB85A	85	94.4	108.2	1.0	5.0	137	4.4	CNV
1SMB90A	90	100	115.5	1.0	5.0	146	4.1	CNX
1SMB100A	100	111	128	1.0	5.0	162	3.7	CNZ
1SMB110A	110	122	140.5	1.0	5.0	177	3.4	CPE
1SMB120A	120	133	153	1.0	5.0	193	3.1	CPG
1SMB130A	130	144	165.5	1.0	5.0	209	2.9	CPK
1SMB150A	150	167	192.5	1.0	5.0	243	2.5	CPM
1SMB160A	160	178	205	1.0	5.0	259	2.3	CPP
1SMB170A	170	189	217.5	1.0	5.0	275	2.2	CPR

**SMB CASE - MECHANICAL OUTLINE**

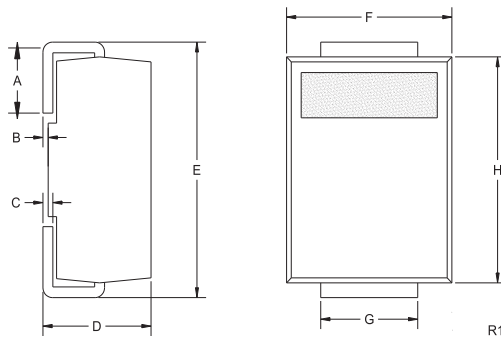

SYMBOL	DIMENSIONS			
	INCHES		MILLIMETERS	
	MIN	MAX	MIN	MAX
A	0.030	0.060	0.76	1.52
B	0.004	0.008	0.10	0.20
C	0.006	0.012	0.15	0.30
D	0.086	0.096	2.18	2.44
E	0.200	0.220	5.08	5.59
F	0.130	0.150	3.30	3.81
G	0.077	0.083	1.96	2.11
H	0.160	0.180	4.06	4.57

SMB (REV: R1)

R4 (20-November 2009)

**1SMB5.0A  
THRU  
1SMB170A**

**SURFACE MOUNT  
UNI-DIRECTIONAL  
GLASS PASSIVATED JUNCTION  
SILICON TRANSIENT  
VOLTAGE SUPPRESSOR  
600 WATTS, 5.0 THRU 170 VOLTS**



### TYPICAL ELECTRICAL CHARACTERISTICS

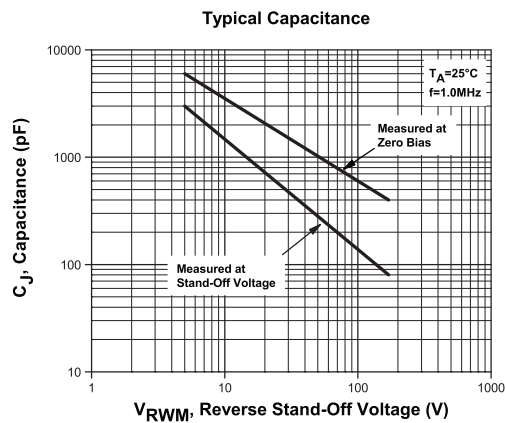
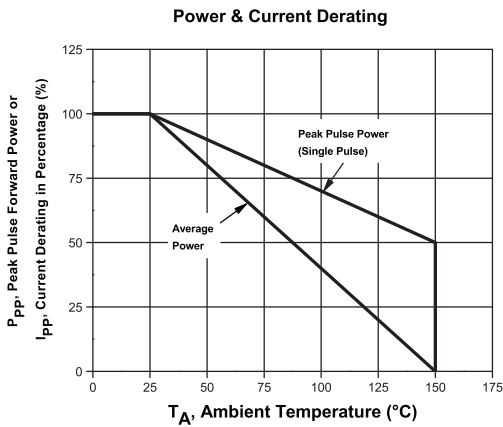
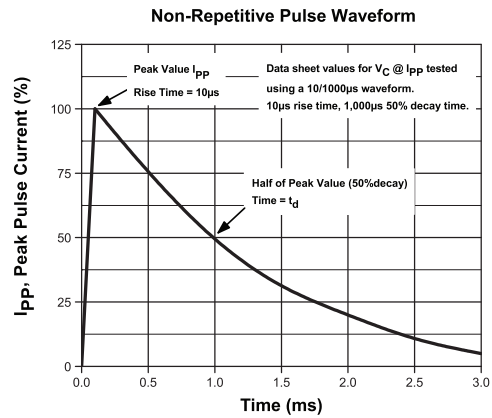
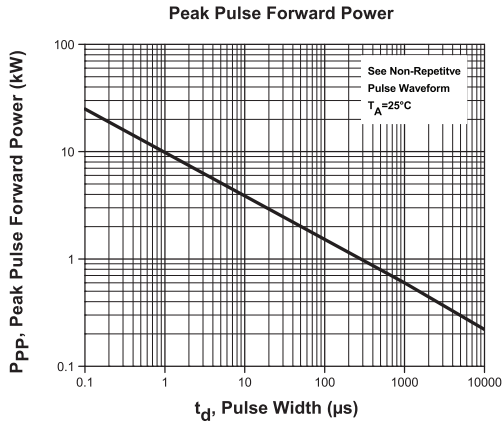

R4 (20-November 2009)

## Данный компонент на территории Российской Федерации

### Вы можете приобрести в компании MosChip.

Для оперативного оформления запроса Вам необходимо перейти по данной ссылке:

<http://moschip.ru/get-element>

Вы можете разместить у нас заказ для любого Вашего проекта, будь то серийное производство или разработка единичного прибора.

В нашем ассортименте представлены ведущие мировые производители активных и пассивных электронных компонентов.

Нашей специализацией является поставка электронной компонентной базы двойного назначения, продукции таких производителей как XILINX, Intel (ex.ALTERA), Vicor, Microchip, Texas Instruments, Analog Devices, Mini-Circuits, Amphenol, Glenair.

Сотрудничество с глобальными дистрибьюторами электронных компонентов, предоставляет возможность заказывать и получать с международных складов практически любой перечень компонентов в оптимальные для Вас сроки.

На всех этапах разработки и производства наши партнеры могут получить квалифицированную поддержку опытных инженеров.

Система менеджмента качества компании отвечает требованиям в соответствии с ГОСТ Р ИСО 9001, ГОСТ РВ 0015-002 и ЭС РД 009

### Офис по работе с юридическими лицами:

105318, г.Москва, ул.Щербаковская д.3, офис 1107, 1118, ДЦ «Щербаковский»

Телефон: +7 495 668-12-70 (многоканальный)

Факс: +7 495 668-12-70 (доб.304)

E-mail: [info@moschip.ru](mailto:info@moschip.ru)

Skype отдела продаж:

moschip.ru

moschip.ru\_4

moschip.ru\_6

moschip.ru\_9