

Description

The AGF600-48S30 is a single output DC-DC converter with standard full-brick outline and pin configuration. It delivers up to 20A output current with 30V output voltage. Above 94.0% ultra-high efficiency and excellent thermal performance make it an ideal choice to supply power to power amplifier in telecom RF application. Aluminium baseplate structure makes it possible for the module to work under -40°C ~ 85°C without air cooling.

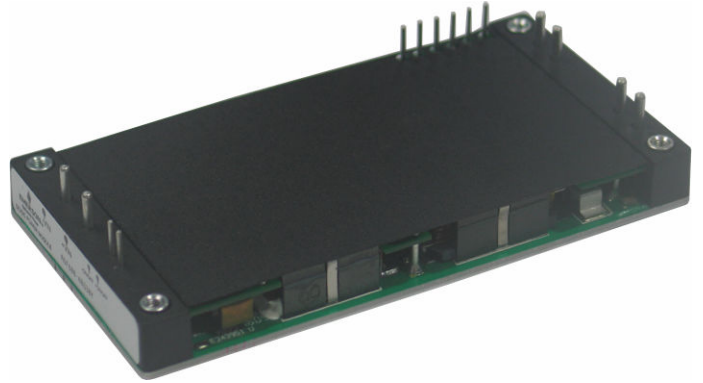

Operational Features

- Delivering up to 20A output current
- Ultra-high efficiency 94.0% typ. at full load
- Excellent thermal performance
- Wide input range: 36V ~ 75V
- No minimum load requirement
- Fixed frequency operation
- RoHS 5 compliant

Control Features

- Remote control function
- Remote output sense
- Trim function: -50% ~ +10%

Protection Features

- Input under voltage protection
- Output over current protection
- Output over voltage protection
- Over temperature protection

Mechanical Features

- Industry standard full-brick pin-out outline
- With aluminium baseplate
- Pin length: 5.8mm

Safety & EMC

- Meets safety standards UL 60950-1, IEC/EN 60950-1 and GB4943
- Approved by UL and TUV
- Meets 2006/95/EEC and 93/68/EEC directives which facilitates CE marking in user's end product
- Meets conducted emission's requirements of EN55022 Class A with external filter

Electrical Characteristics

Full operating ambient temperature range is -40°C to +85°C.

Specifications are subject to change without notice.

Parameter		Min.	Typ.	Max.	Unit	Notes & Conditions
Absolute max. ratings						
Input voltage	Non-operating			100	V	100ms
	Operating			80	V	Continuous
Operating temperature		-40		85	°C	
Storage temperature		-55		125	°C	
Input characteristics						
Operating input voltage range		36	48	75	V	
Input under-voltage lockout	Turn-on voltage threshold	31	35	36	V	
	Turn-off voltage threshold	30	33	35	V	
	Lockout voltage hysteresis	1	1.5	3	V	
Max. input current				20	A	36V _{in} , full load
No-load input current			0.2	0.3	A	48V _{in}
Standby Input current			0.02	0.1	A	Remote OFF
Input reflected ripple current				160	mA	Through 12μH inductor; Figure 16
Recommended input fuse			30		A	Fast blow external fuse recommended Figure 11
Input filter component values (C/L)			15\0.55		μF\μH	Internal values
Recommended external input capacitance		470			μF	Low ESR capacitor recommended Figure 11
Output characteristics						
Output voltage set point (standard option)		29.70	30	30.30	V	48V _{in} , full load
Output voltage line regulation			0.05	0.2	%	
			15	60	mV	
Output voltage load regulation			0.2	0.5	%	
			60	150	mV	
Output voltage temperature regulation				0.02	%/°C	

Parameter		Min.	Typ.	Max.	Unit	Notes & Conditions
Total output voltage range		29.10	30	30.90	V	Over sample, line, load, temperature & life
Output voltage ripple and noise			80	250	mVpp	20MHz bandwidth; Figure 16
Operating output current range		0		20	A	
Output DC current-limit inception		22		30	A	Hiccup, see Figure 10
Output capacitance *		470	1000	10000	μF	
Dynamic characteristics						
Dynamic response	25% ~ 50% ~ 25% $I_{o,max}$, 0.1A/μs		400	840	mV	Figure 4 Test condition: see Figure 11
	Settling time		60	500	μs	Recovery to within 1% $V_{o,nom}$
	50% ~ 75% ~ 50% $I_{o,max}$, 0.1A/μs		400	840	mV	Figure 5 Test condition: see Figure 11
	Settling time		60	500	μs	Recovery to within 1% $V_{o,nom}$
Turn-on transient	Rise time		200	500	ms	Full load, Figure 6
	Turn-on delay time		140	300	ms	
	Output voltage overshoot			5	% V_o	
Efficiency						
100% load			94.0		%	Figure 1
50% load			94.5		%	Figure 1

* Out voltage can be start up when out external electrolytic Capacitor is 100uF/50V.

Electrical Characteristics (Continued)

Parameter	Min.	Typ.	Max.	Unit	Notes & Conditions
Isolation characteristics					
Isolation voltage (1mA, 5s)		1500		V	Basic insulation, pollution degree 2, input to output
		1000		V	Basic insulation, pollution degree 2, input to baseplate
		500		V	Basic insulation, pollution degree 2, output to baseplate

Parameter	Min.	Typ.	Max.	Unit	Notes & Conditions
Feature characteristics					
Switching frequency	260	290	320	kHz	
Remote ON/OFF control	1.5		5	mA	See Figure 12, Figure 13
Output voltage trim range	15		33	V	See <i>Trim Characteristics of Application Note</i>
Output voltage remote sense range			0.5	V	
Output over-voltage protection	36		40	V	Over full temp range; Hiccup
Over-temperature shutdown	105	110	125	°C	Auto recovery; Test point: see Figure 19
Over-temperature hysteresis	5			°C	
Reliability characteristics					
Calculated MTBF (telcordia)		1.5		10 ⁶ h	Telcordia SR-332-2006; 80% load, 300LFM, 40°C T _a

Qualification Testing

Parameter	Unit (pcs)	Test condition
Halt test	4 ~ 5	T _{a,min} -10°C to T _{a,max} +10°C, 5°C step, V _{in} = min to max, 0 ~ 105% load
Vibration	3	Frequency range: 5Hz ~ 20Hz, 20Hz ~ 200Hz, A.S.D: 1.0m ² /s ³ , -3db/oct, axes of vibration: X/Y/Z; Time: 30min/axis
Mechanical shock	3	30g, 6ms, 3axes, 6directions, 3time/direction
Thermal shock	3	-40°C to 100°C, unit temperature 20cycles
Thermal cycling	3	-40°C to 85°C, temperature change rate: 1°C/min, cycles: 2cycles
Humidity	3	40°C, 95%RH, 48h
Solder ability	15	IPC J-STD-002C-2007

Characteristic Curves

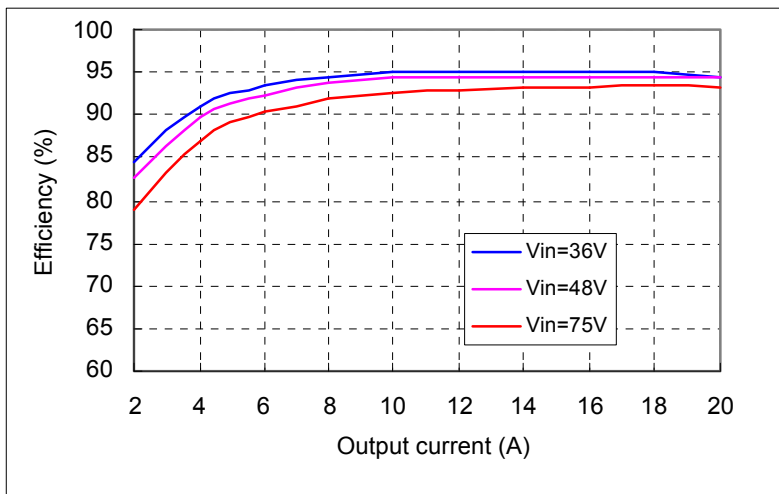

Figure 1 Efficiency vs. output current, $T_a=25^{\circ}\text{C}$, $T_c=40^{\circ}\text{C}$, $V_o=30\text{V}$

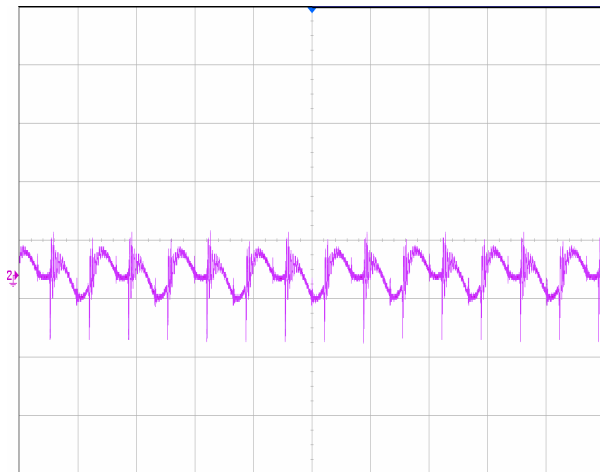

Figure 2 Output ripple & noise (5 $\mu\text{s}/\text{div}$, 50mV/div), see Figure 16 for test configuration

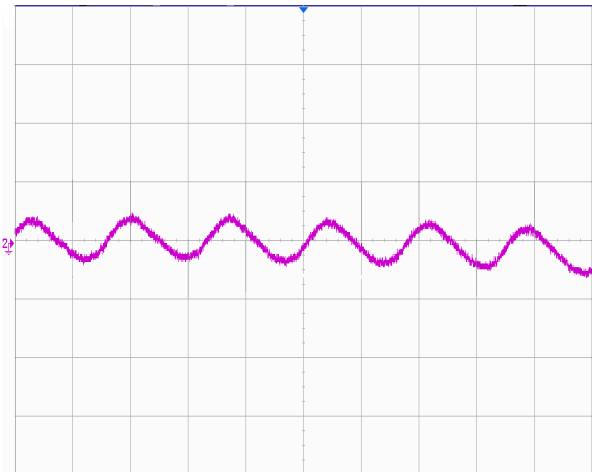

Figure 3 Input reflected ripple current (2 $\mu\text{s}/\text{div}$, 20mA/div), see Figure 16 for test configuration

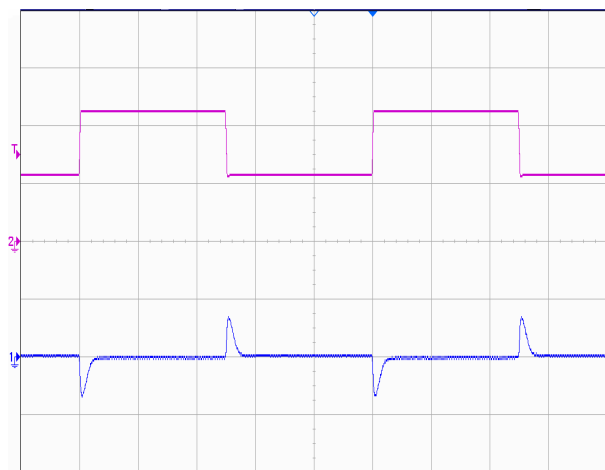

Figure 4 Dynamic response for 25% load step (25% ~ 50% ~ 75%) and 0.1A/ μ s slew rate, see Figure 11 for test configuration, CH1-output voltage (500mV/div); CH2-output current (5A/div)

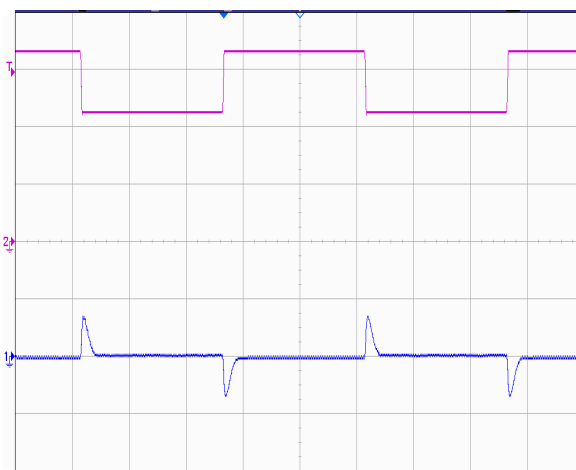

Figure 5 Dynamic response for 25% load step (50% ~ 75% ~ 50%) and 0.1A/ μ s slew rate, see Figure 11 for test configuration. CH1-output voltage (500mV/div); CH2-output current (5A/div)

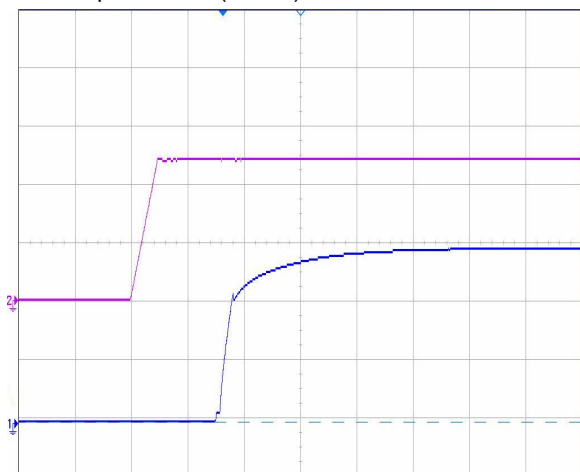

Figure 6 Output voltage startup by power on, (5ms/div), see Figure 11 for test configuration, CH2-input voltage (20V/div); CH1-output voltage (10V/div)

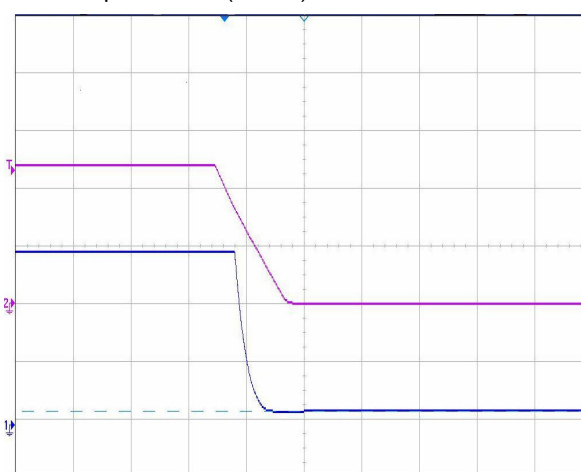

Figure 7 Output voltage shut down by power off, (5ms/div), see Figure 11 for test configuration, CH2-input voltage (20V/div); CH1-output voltage (10V/div)

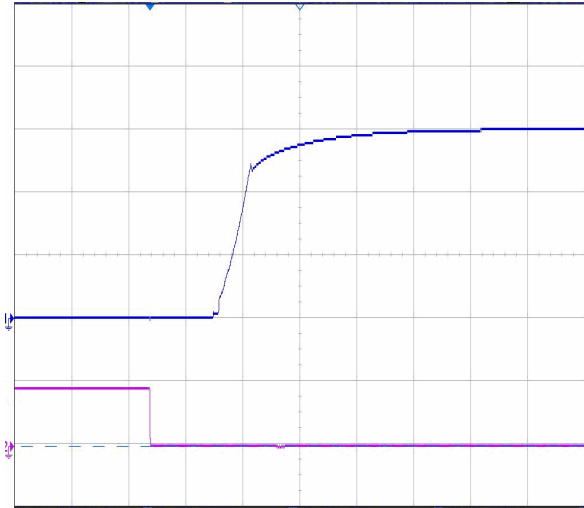

Figure 8 Output voltage startup by remote ON, (20ms/div), see Figure 12 for test configuration, CH2-remote ON (50V/div); CH1-output voltage (10V/div)

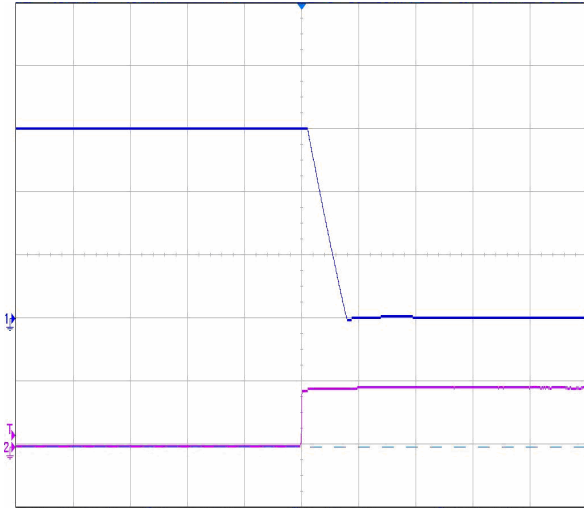

Figure 9 Output voltage shutdown by remote OFF, (1ms/div), see Figure 12 for test configuration, CH2-remote OFF (50V/div); CH1-output voltage (10V/div)

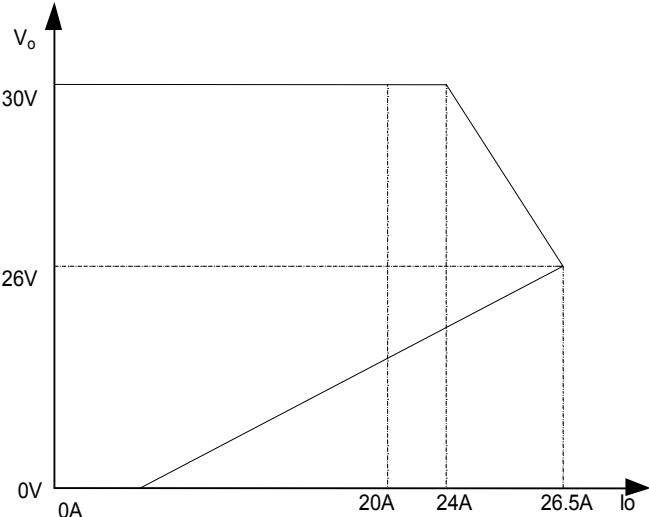

Figure 10 Over-current protection characteristics

Note: It's only a sketch map of OCP action. Little alterations of the current value vs. voltage value are allowed.

Application Note

Typical Application

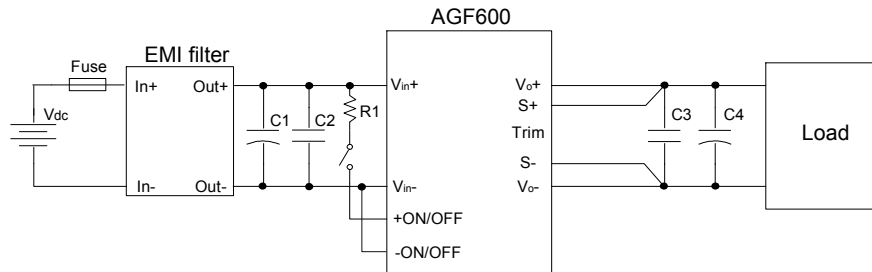

Figure 11 Typical application

R1: 24k Ω (1/2W), current limiting resistor

C1: 470 μ F/100V electrolytic capacitor, P/N: UPW2A471MHD (Nichicon) or equivalent caps.

C2, C3: 1 μ F/100V X7R ceramic capacitor, P/N: C3225X7R2A105KT0L0U(TDK) or equivalent caps

C4: 1000 μ F/50V electrolytic capacitor, P/N: UPM1H102MHD (Nichicon) or equivalent caps

External fast-acting fuse with a rating of 30A should be used in the application. The recommended fuse model is 0324030 or 314030 from LITTELFUSE.

Remote ON/OFF

A remote ON/OFF control circuit is provided which is isolated from the input side, as well as, the output side. (Isolation withstand voltage: 1.5kVdc).

Connection of remote ON/OFF terminal is as follows. As shown in the figure below, output voltage turns remote ON when current is made to flow through remote ON/OFF terminal. Remote ON/OFF terminal can be controlled by opening or closing connections (with switch or relay).

Maximum source current for remote ON/OFF terminal is 5mA. Therefore, set current limiting resistor value such that this maximum source current value is not exceeded. Also, the allowable maximum reverse current flow is 5mA.

Controlling the remote ON/OFF terminal from the input side

Connect current limiting resistor R1 is shown in the following figure.

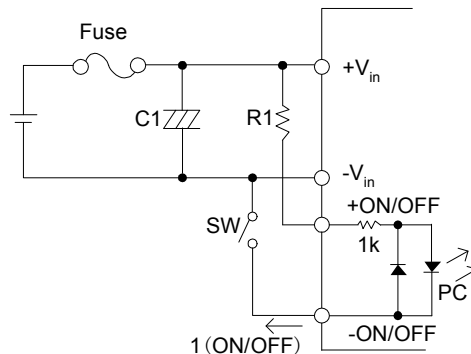

Figure 12 Connection of remote ON/OFF control (A)

R1: Recommended resistor value: 24kΩ (1/2W)

Controlling the remote ON/OFF terminal from the output side

Connect the current limiting resistor R1 is shown in the following figure.

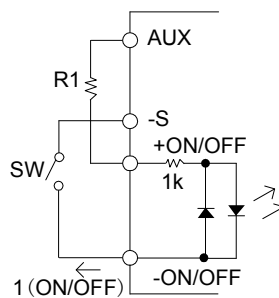

Figure 13 Connection of remote ON/OFF control (B)

R1: Recommended resistor value: 2kΩ (1/2W)

Note:

1. When wiring becomes long, connect a capacitor of about 0.1μF value between the +remote ON/OFF terminal and –remote ON/OFF terminal at a nearest distance.
2. Current limiting resistor can also be connected to the –remote ON/OFF terminal side.
3. The remote ON/OFF control mode is shown in the following table.

Remote ON/OFF level	Output status
Open (<100μA)	Remote OFF
1.5mA ≤ I (ON/OFF) ≤ 5mA	Remote ON

Trim Characteristics

The output voltage of the converter can be trimmed using the trim pin provided. Applying a resistor between the trim pin and –S will cause the output to decrease. Applying a resistor between the +V_o and +S will cause the output to increase. Trimming down more than 50% and trimming up more

than 10% can cause the module to regulate improperly. If the trim pin is not needed, it should be left open.

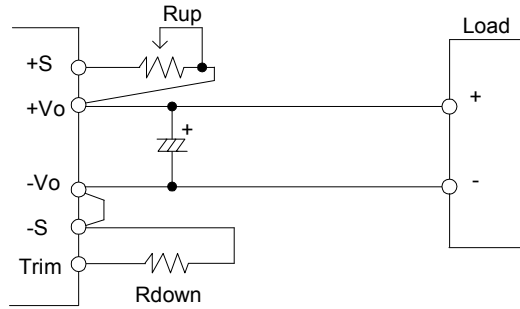

Figure 14 Trim circuit

$$R_{up} = 30 \left(\frac{V_o - V_e}{V_e} \right) k\Omega$$

$$R_{down} = -5.97 \left(\frac{V_o}{V_o - V_e} \right) k\Omega$$

V_e is the rated output voltage and V_o is the goal voltage.

For example, to get 33V output, the resistor is:

$$R_{up} = 30 \left(\frac{33 - 30}{30} \right) k\Omega = 3k\Omega$$

For another example, to get 15V output, the resistor is:

$$R_{down} = -5.97 \left(\frac{15}{15 - 30} \right) k\Omega = 5.97k\Omega$$

Take note that when output voltage is increased, input voltage should be limited is shown in the following figure.

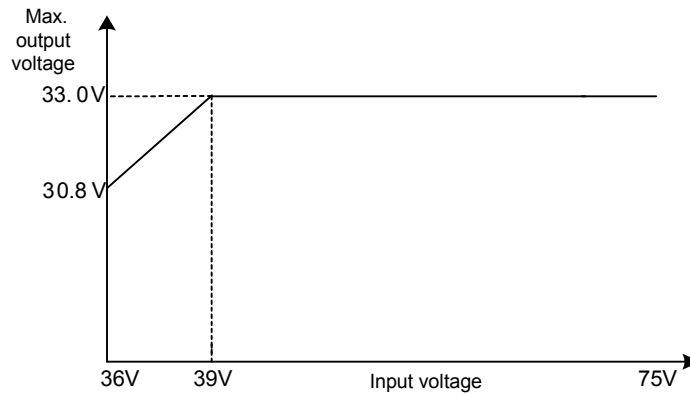

Figure 15 Trim-up-able voltage vs. input voltage

Sense Characteristics

If the load is far from the unit, connect S+ and S- to the terminal of the load respectively to compensate the voltage drop on the transmission line. See Figure 11.

If the sense compensation function is not necessary, short S+ to V_o+ and S- to V_o- respectively.

Input Ripple & Inrush Current and Output Ripple & Noise Test Configuration

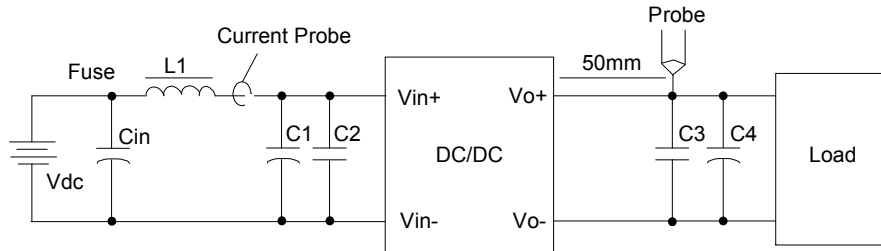

Figure 16 Ripple & noise test configuration

Vdc: DC power supply

L1: 12 μ H

Cin: 220 μ F/100V typical.

C1 ~ C4: See Figure 11

Note: Using a coaxial cable with series 50 Ω resistor and 0.68 μ F ceramic capacitor or a ground ring of probe to test output ripple & noise is recommended.

EMC Filter Configuration

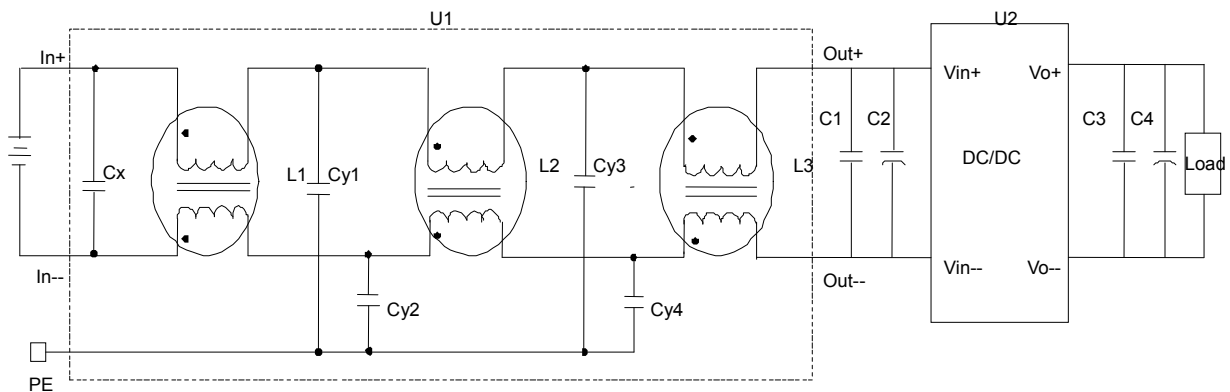

Figure 17 EMC test configuration

Cx: 5.7 μ F/100V capacitor

Cy1, Cy2, Cy3, Cy4: 4700pF, Y capacitor

L1, L2, L3: 100 μ H, common mode inductor

C1 ~ C4: See Figure 11

U1: 20A input EMC filter module (P/N: FM100-20)

U2: Converter under test, AGF600-48S30Y

Mechanical Diagram

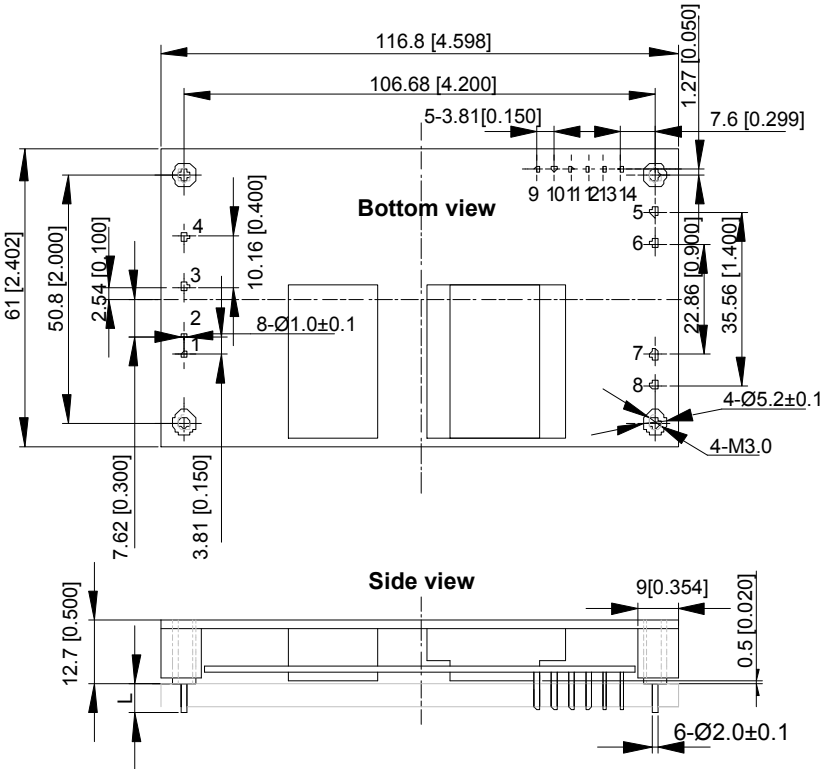

Unit: mm[inch] Bottom view: pin on upside
 Tolerance: X.Xmm±0.5mm[X.X in.±0.02in.]
 X.XXmm±0.25mm[X.XX in.±0.01in.]

Figure 18 Mechanical diagram

Pin length option

Device code suffix	L
-4	4.8mm±0.5 mm
-6	3.8mm±0.5mm
-8	2.8mm±0.5mm
None	5.8mm±0.5mm

Pin Designations

Pin NO.	Name	Function
1	+On/Off	Remote control
2	-On/Off	Remote control
3	V _{in+}	Positive input voltage
4	V _{in-}	Negative input voltage
5, 6	V _{o-}	Negative output voltage
7, 8	V _{o+}	Positive output voltage
9	AUX	Auxiliary voltage
10	I OG	Inverter operation good
11	NC	
12	Trim	Trim terminal
13	+S	Remote sensing +
14	-S	Remote sensing -

Soldering

The product is intended for standard manual or wave soldering.

When wave soldering is used, the temperature on pins is specified to maximum 255°C for maximum 7s.

When soldering by hand, the iron temperature should be maintained at 300°C ~ 380°C and applied to the converter pins for less than 10s. Longer exposure can cause internal damage to the converter. Cleaning of solder joint can be performed with cleaning solvent IPA or similitive.

Thermal Considerations

The converter can operate in a enclosed environment without forced air convection. Cooling of the converter is achieved mainly by conduction from the baseplate to a heatsink. The converter can deliver full output power at 85°C ambient temperature provided the baseplate temperature is kept below the max values 100°C.

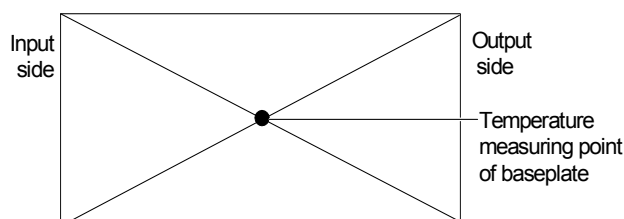

Figure 19 Temperature test point on base plate

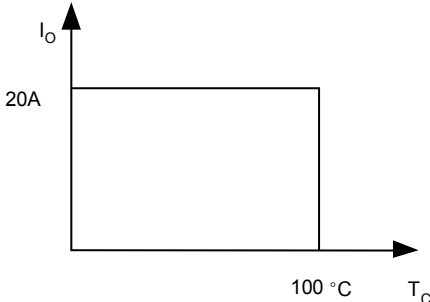

Figure 20 Output power derating curve, T_c : temperature test point on baseplate, see Figure 19

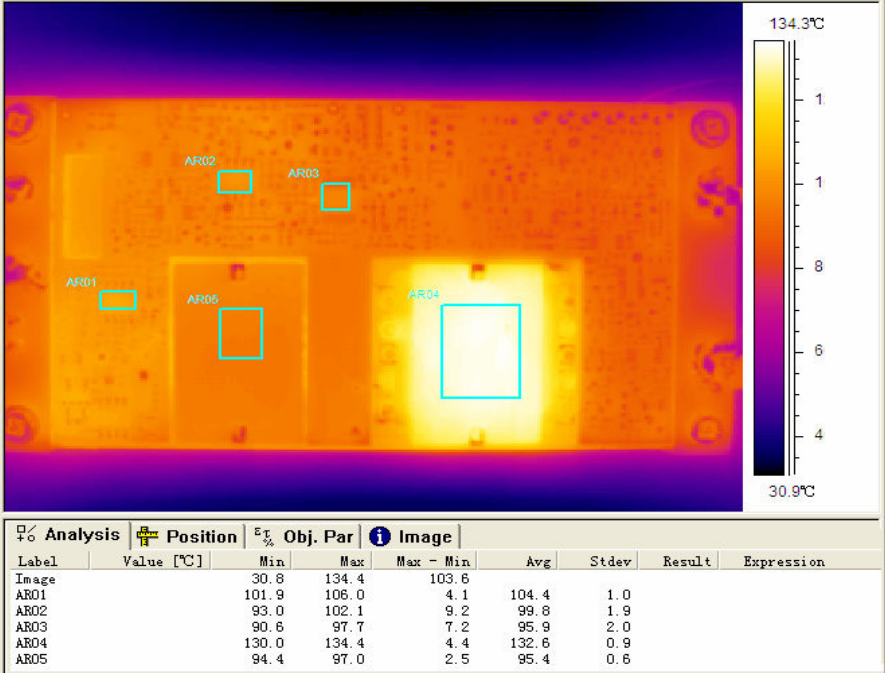

Figure 21 Thermal image, 48V_{in}, 30V_o, full load, room temperature

Ordering Information

AGF600	-	48	S	30		Y
①		②	③	④		⑤

①	Model series	AGF: high efficiency full brick series; 600: output power 600W
②	Input voltage	48: 36V ~ 75V input range, rated input voltage 48V
③	Output channel	S: single output
④	Rated output voltage	30: 30V output
⑤	Pin length	None: 5.8mm
⑥	RoHS status	Y: RoHS, R5

Model number	Description
AGF600-48S30Y	5.8mm pin length; with thread inside mounting hole; R5 compliat

Hazardous Substances Announcement (RoHS of China)

Parts	Hazardous Substances					
	Pb	Hg	Cd	Cr ⁶⁺	PBB	PBDE
AGF600-48S30Y	√	○	○	○	○	○
○: Means the content of the hazardous substances in all the average quality materials of the part is within the limits specified in SJ/T-11363-2006 √: Means the content of the hazardous substances in at least one of the average quality materials of the part is outside the limits specified in SJ/T11363-2006						
Emerson Network Power Co., Ltd. has been committed to the design and manufacturing of environment-friendly products. It will reduce and eventually eliminate the hazardous substances in the products through unremitting efforts in research. However, limited by the current technical level, the following parts still contain hazardous substances due to the lack of reliable substitute or mature solution: <ol style="list-style-type: none"> 1. Solders (including high-temperature solder in parts) contain plumbum. 2. Glass of electric parts contains plumbum. 3. Copper alloy of pins contains plumbum 						

Данный компонент на территории Российской Федерации

Вы можете приобрести в компании MosChip.

Для оперативного оформления запроса Вам необходимо перейти по данной ссылке:

<http://moschip.ru/get-element>

Вы можете разместить у нас заказ для любого Вашего проекта, будь то серийное производство или разработка единичного прибора.

В нашем ассортименте представлены ведущие мировые производители активных и пассивных электронных компонентов.

Нашей специализацией является поставка электронной компонентной базы двойного назначения, продукции таких производителей как XILINX, Intel (ex.ALTERA), Vicor, Microchip, Texas Instruments, Analog Devices, Mini-Circuits, Amphenol, Glenair.

Сотрудничество с глобальными дистрибьюторами электронных компонентов, предоставляет возможность заказывать и получать с международных складов практически любой перечень компонентов в оптимальные для Вас сроки.

На всех этапах разработки и производства наши партнеры могут получить квалифицированную поддержку опытных инженеров.

Система менеджмента качества компании отвечает требованиям в соответствии с ГОСТ Р ИСО 9001, ГОСТ РВ 0015-002 и ЭС РД 009

Офис по работе с юридическими лицами:

105318, г.Москва, ул.Щербаковская д.3, офис 1107, 1118, ДЦ «Щербаковский»

Телефон: +7 495 668-12-70 (многоканальный)

Факс: +7 495 668-12-70 (доб.304)

E-mail: info@moschip.ru

Skype отдела продаж:

moschip.ru

moschip.ru_4

moschip.ru_6

moschip.ru_9