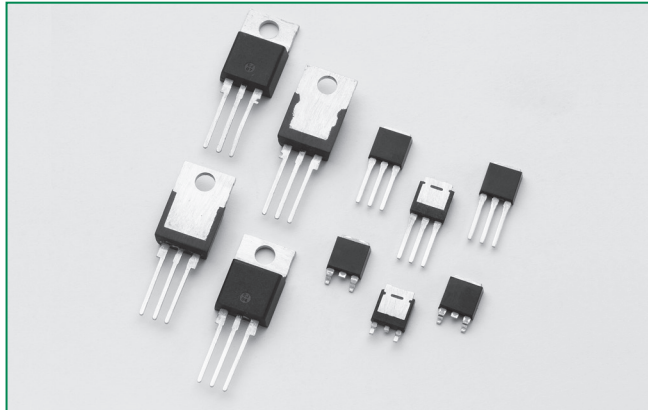


**RoHS** **Sxx10xSx & Sxx10x Series**



**Description**

Excellent unidirectional switches for phase control and general switching applications such as heating and motor speed controls.

Sensitive gate SCRs are easily triggered with microAmps of current as furnished by sense coils, proximity switches, and microprocessors.

Standard phase control SCRs are triggered with few milliamperes of current at less than 1.5V potential.

**Features & Benefits**

- RoHS compliant
- Glass – passivated junctions
- Voltage capability up to 1000 V
- Surge capability up to 100 A

**Applications**

Typical applications are capacitive discharge systems for strobe lights, nailers, staplers and gas engine ignition. Also controls for power tools, home/brown goods and white goods appliances.

Internally constructed isolated packages are offered for ease of heat sinking with highest isolation voltage.

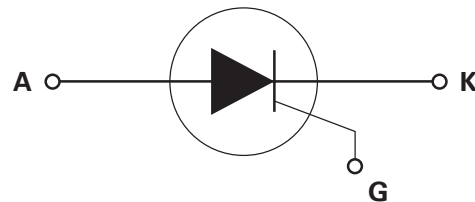
**Agency Approval**

Agency	Agency File Number
	TO-220L Package : E71639

**Main Features**

Symbol	Value	Unit
$I_{T(RMS)}$	10	A
$V_{DRM}/V_{RRM}$	400 to 1000	V
$I_{GT}$	0.2 to 15	mA

**Schematic Symbol**



**Absolute Maximum Ratings – Sensitive SCRs**

Symbol	Parameter	Test Conditions		Value	Unit
$I_{T(RMS)}$	RMS on-state current	Sxx10LSy	$T_c = 80^\circ\text{C}$	10	A
		Sxx10RSy Sxx10DSy Sxx10Vsy	$T_c = 95^\circ\text{C}$		
$I_{T(AV)}$	Average on-state current	Sxx10LSy	$T_c = 80^\circ\text{C}$	6.4	A
		Sxx10RSy Sxx10DSy Sxx10Vsy	$T_c = 95^\circ\text{C}$		
$I_{TSM}$	Peak non-repetitive surge current	single half cycle; $f = 50\text{Hz}$ ; $T_J$ (initial) = $25^\circ\text{C}$		83	A
		single half cycle; $f = 60\text{Hz}$ ; $T_J$ (initial) = $25^\circ\text{C}$		100	
$I^2t$	$I^2t$ Value for fusing	$t_p = 8.3 \text{ ms}$		41	$\text{A}^2\text{s}$
$di/dt$	Critical rate of rise of on-state current	$f = 60 \text{ Hz}; T_J = 110^\circ\text{C}$		100	$\text{A}/\mu\text{s}$
$I_{GM}$	Peak gate current	$T_J = 110^\circ\text{C}$		1	A
$P_{G(AV)}$	Average gate power dissipation	$T_J = 110^\circ\text{C}$		0.1	W
$T_{stg}$	Storage temperature range			-40 to 150	$^\circ\text{C}$
$T_J$	Operating junction temperature range			-40 to 110	$^\circ\text{C}$

Note: xx = voltage, y = sensitivity

**Absolute Maximum Ratings – Standard SCRs**

Symbol	Parameter	Test Conditions		Value	Unit
$I_{T(RMS)}$	RMS on-state current	Sxx10L	$T_c = 95^\circ\text{C}$	10	A
		Sxx10R Sxx10D Sxx10V	$T_c = 105^\circ\text{C}$		
$I_{T(AV)}$	Average on-state current	Sxx10L	$T_c = 95^\circ\text{C}$	6.4	A
		Sxx10R Sxx10D Sxx10V	$T_c = 105^\circ\text{C}$		
$I_{TSM}$	Peak non-repetitive surge current	single half cycle; $f = 50\text{Hz}$ ; $T_J$ (initial) = $25^\circ\text{C}$		83	A
		single half cycle; $f = 60\text{Hz}$ ; $T_J$ (initial) = $25^\circ\text{C}$		100	
$I^2t$	$I^2t$ Value for fusing	$t_p = 8.3 \text{ ms}$		41	$\text{A}^2\text{s}$
$di/dt$	Critical rate-of-rise of on-state current	$f = 60 \text{ Hz}; T_J = 125^\circ\text{C}$		100	$\text{A}/\mu\text{s}$
$I_{GM}$	Peak gate current	$T_J = 125^\circ\text{C}$		2	A
$P_{G(AV)}$	Average gate power dissipation	$T_J = 125^\circ\text{C}$		0.5	W
$T_{stg}$	Storage temperature range			-40 to 150	$^\circ\text{C}$
$T_J$	Operating junction temperature range			-40 to 125	$^\circ\text{C}$

Note: xx = voltage

**Electrical Characteristics ( $T_J = 25^\circ\text{C}$ , unless otherwise specified) – Sensitive SCRs**

Symbol	Test Conditions		Value		Unit
			Sxx10xS2	Sxx10xS3	
$I_{GT}$	$V_D = 6V$ $R_L = 100 \Omega$	MAX.	200	500	$\mu\text{A}$
$V_{GT}$		MAX.	0.8		V
dv/dt	$V_D = V_{DRM}$ ; $R_{GK} = 1k\Omega$ ; $T_J = 110^\circ\text{C}$	TYP.	8		V/ $\mu\text{s}$
$V_{GD}$	$V_D = V_{DRM}$ ; $R_L = 3.3 k\Omega$ ; $T_J = 110^\circ\text{C}$	MIN.	0.2		V
$V_{GRM}$	$I_{GR} = 10\mu\text{A}$	MIN.	6		V
$I_H$	$I_T = 20\text{mA}$ (initial)	MAX.	6	8	mA
$t_q$	(1)	MAX.	50	45	$\mu\text{s}$
$t_{gt}$	$I_G = 2 \times I_{GT}$ ; $PW = 15\mu\text{s}$ ; $I_T = 12\text{A}$	TYP.	4	5	$\mu\text{s}$

NOTE: xx = voltage, x = package

(1)  $I_T=2\text{A}$ ;  $t_p=50\mu\text{s}$ ;  $dv/dt=5\text{V}/\mu\text{s}$ ;  $di/dt=-30\text{A}/\mu\text{s}$

**Electrical Characteristics ( $T_J = 25^\circ\text{C}$ , unless otherwise specified) – Standard SCRs**

Symbol	Test Conditions			Value	Unit
				Sxx10x	
$I_{GT}$	$V_D = 12V$ $R_L = 60 \Omega$		MAX.	15	mA
$V_{GT}$			MAX.	1.5	V
dv/dt	$V_D = V_{DRM}$ ; gate open; $T_J = 100^\circ\text{C}$	400V	MIN.	350	V/ $\mu\text{s}$
		600V		300	
		800V		250	
		1000V		100	
	$V_D = V_{DRM}$ ; gate open; $T_J = 125^\circ\text{C}$	400V		250	
		600V		225	
	800V	200			
$V_{GD}$	$V_D = V_{DRM}$ ; $R_L = 3.3 k\Omega$ ; $T_J = 125^\circ\text{C}$		MIN.	0.2	V
$I_H$	$I_T = 200\text{mA}$ (initial)		MAX.	30	mA
$t_q$	(1)		MAX.	35	$\mu\text{s}$
$t_{gt}$	$I_G = 2 \times I_{GT}$ ; $PW = 15\mu\text{s}$ ; $I_T = 20\text{A}$		TYP.	2	$\mu\text{s}$

NOTE: xx = voltage, x = package

(1)  $I_T=2\text{A}$ ;  $t_p=50\mu\text{s}$ ;  $dv/dt=5\text{V}/\mu\text{s}$ ;  $di/dt=-30\text{A}/\mu\text{s}$

**Static Characteristics**

Symbol	Test Conditions		Value	Unit
$V_{TM}$	$I_T = 20\text{A}$ ; $t_p = 380 \mu\text{s}$		MAX.	1.6 V
$I_{DRM} / I_{RRM}$	Sxx10xyy	$T_J = 25^\circ\text{C}$	400 - 600V	5
		$T_J = 110^\circ\text{C}$	400 - 600V	250
	Sxx10x	$T_J = 25^\circ\text{C}$	400 - 800V	10
			1000V	20
		$T_J = 100^\circ\text{C}$	400 - 800V	200
			1000V	3000
$T_J = 125^\circ\text{C}$	400 - 800V	500		

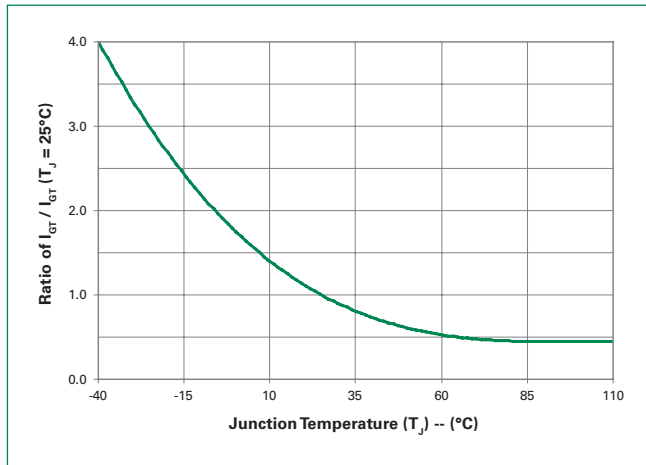
Note: xx = voltage, x = package, yy = sensitivity

**Thermal Resistances**

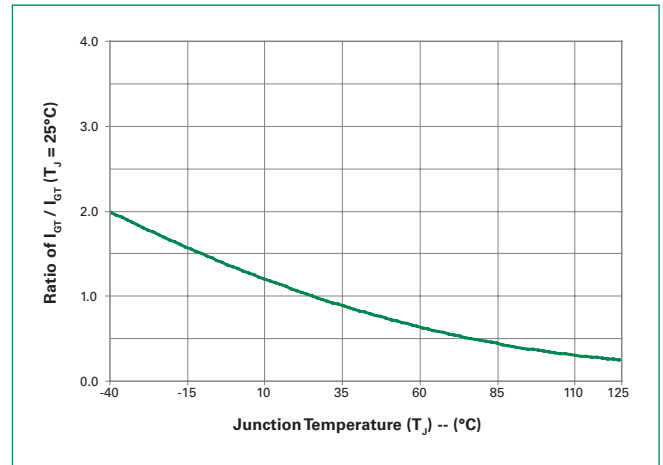
Symbol	Parameter	Value	Unit	
$R_{\theta(J-C)}$	Junction to case (AC)	Sxx10RSy	1.6	°C/W
		Sxx10LSy	3.0	
		Sxx10Vsy	1.7	
		Sxx10DSy	1.45	
		Sxx10R	1.6	
		Sxx10L	3.0	
		Sxx10V	1.7	
		Sxx10D	1.45	
$R_{\theta(J-A)}$	Junction to ambient	Sxx10RSy	40	°C/W
		Sxx10LSy	65	
		Sxx10Vsy	85	
		Sxx10R	40	
		Sxx10L	50	
		Sxx10V	70	

Note: xx = voltage, y = sensitivity

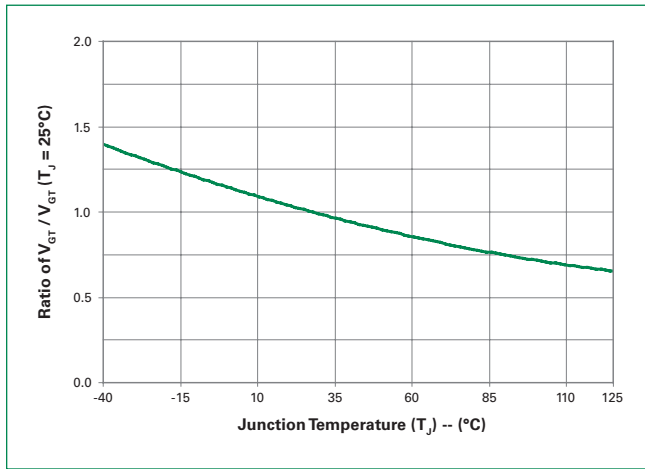
**Figure 1: Normalized DC Gate Trigger Current vs. Junction Temperature (Sensitive SCR)**



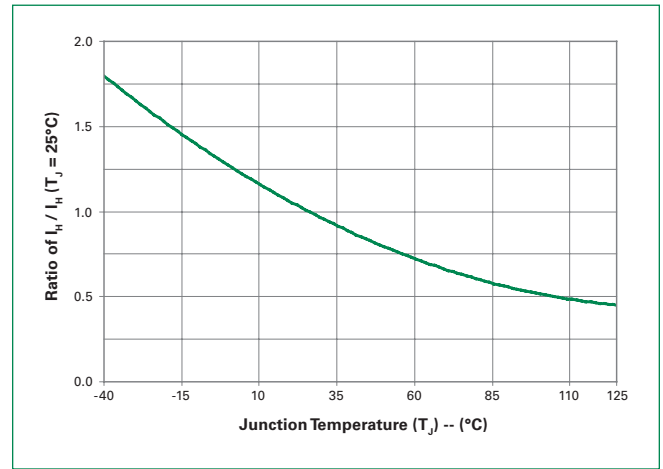
**Figure 2: Normalized DC Gate Trigger Current vs. Junction Temperature (Standard SCR)**



**Figure 3: Normalized DC Gate Trigger Voltage vs. Junction Temperature**



**Figure 4: Normalized DC Holding Current vs. Junction Temperature**



**Figure 5: On-State Current vs. On-State Voltage (Typical)**



**Figure 6: Power Dissipation (Typical) vs. RMS On-State Current**



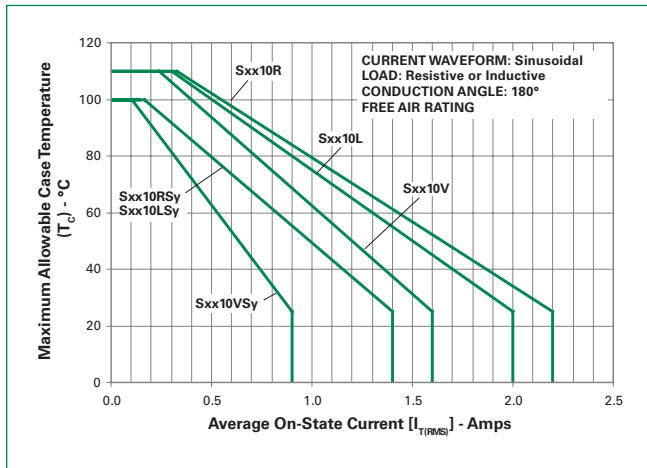
**Figure 7: Maximum Allowable Case Temperature vs. RMS On-State Current**



**Figure 8: Maximum Allowable Case Temperature vs. Average On-State Current**

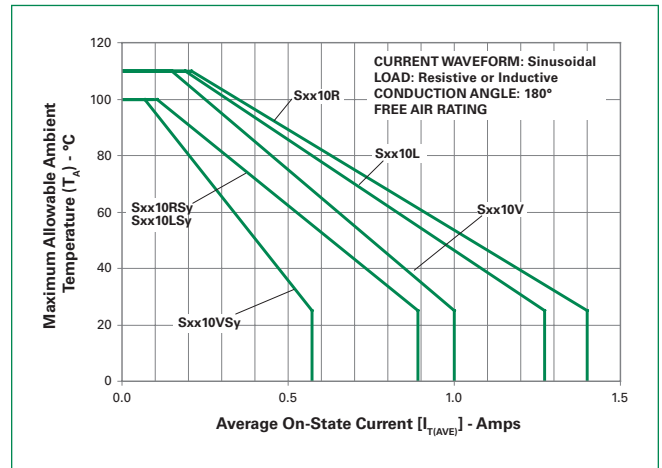


**Figure 9: Maximum Allowable Ambient Temperature vs. RMS On-State Current**

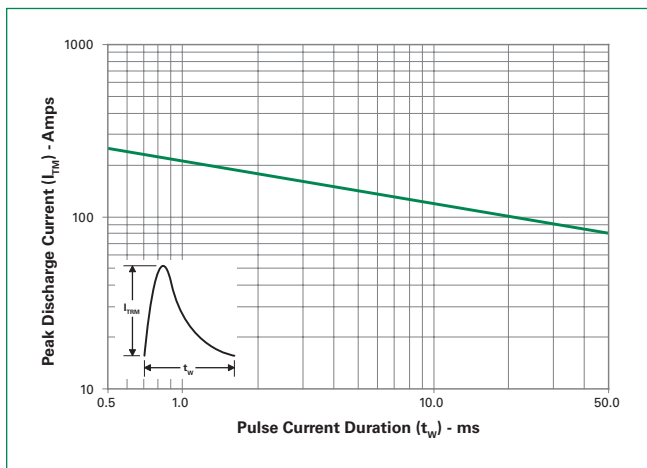


Note: xx = voltage, y = sensitivity

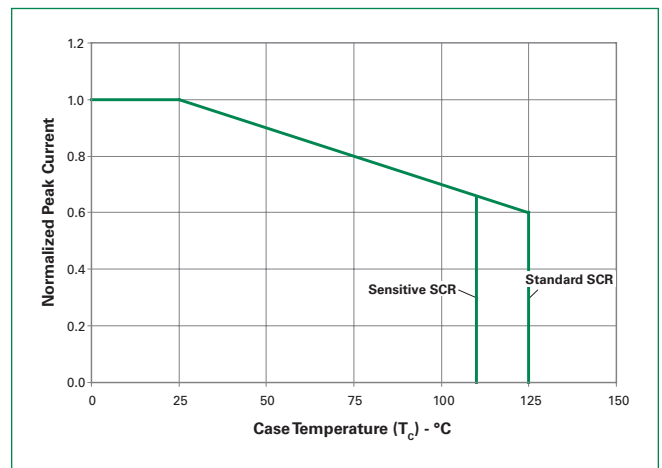
**Figure 10: Maximum Allowable Ambient Temperature vs. Average On-State Current**



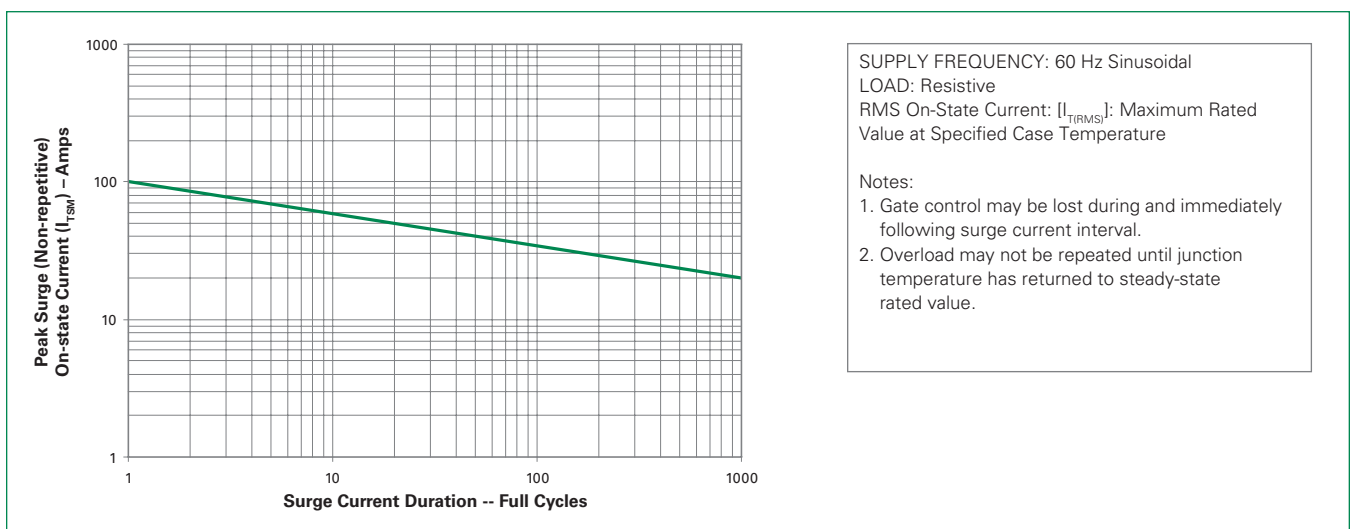
**Figure 11: Peak Capacitor Discharge Current**



**Figure 12: Peak Capacitor Discharge Current Derating**



**Figure 13: Surge Peak On-State Current vs. Number of Cycles**



### Soldering Parameters

Reflow Condition		Pb – Free assembly
Pre Heat	- Temperature Min ( $T_{s(min)}$ )	150°C
	- Temperature Max ( $T_{s(max)}$ )	200°C
	- Time (min to max) ( $t_s$ )	60 – 180 secs
Average ramp up rate (Liquidus Temp ( $T_L$ ) to peak)		5°C/second max
$T_{s(max)}$ to $T_L$ - Ramp-up Rate		5°C/second max
Reflow	- Temperature ( $T_L$ ) (Liquidus)	217°C
	- Temperature ( $t_L$ )	60 – 150 seconds
Peak Temperature ( $T_p$ )		260 <sup>+0/-5</sup> °C
Time within 5°C of actual peak Temperature ( $t_p$ )		20 – 40 seconds
Ramp-down Rate		5°C/second max
Time 25°C to peak Temperature ( $T_p$ )		8 minutes Max.
Do not exceed		280°C



### Physical Specifications

<b>Terminal Finish</b>	100% Matte Tin-plated
<b>Body Material</b>	UL recognized epoxy meeting flammability classification 94V-0
<b>Lead Material</b>	Copper Alloy

### Design Considerations

Careful selection of the correct device for the application's operating parameters and environment will go a long way toward extending the operating life of the Thyristor. Good design practice should limit the maximum continuous current through the main terminals to 75% of the device rating. Other ways to ensure long life for a power discrete semiconductor are proper heat sinking and selection of voltage ratings for worst case conditions. Overheating, overvoltage (including dv/dt), and surge currents are the main killers of semiconductors. Correct mounting, soldering, and forming of the leads also help protect against component damage.

### Environmental Specifications

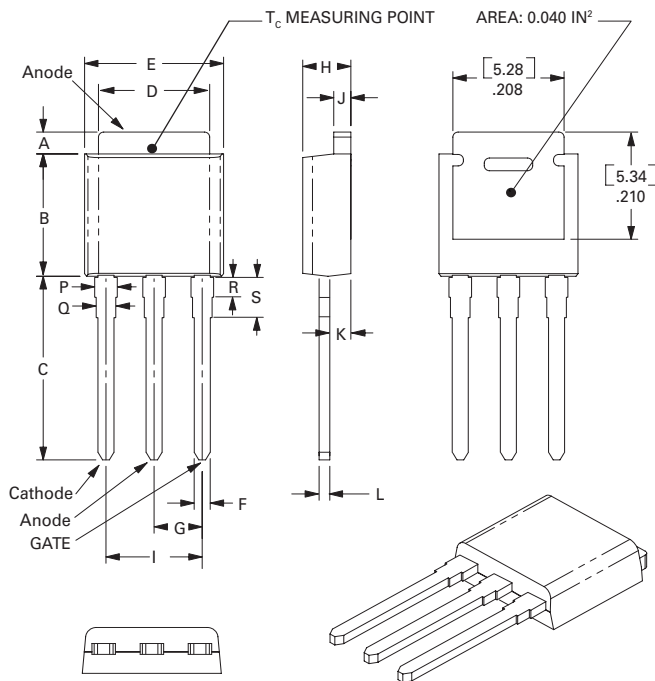
Test	Specifications and Conditions
<b>AC Blocking</b>	MIL-STD-750, M-1040, Cond A Applied Peak AC voltage @ 125°C for 1008 hours
<b>Temperature Cycling</b>	MIL-STD-750, M-1051, 100 cycles; -40°C to +150°C; 15-min dwell-time
<b>Temperature/Humidity</b>	EIA / JEDEC, JESD22-A101 1008 hours; 320V - DC; 85°C; 85% rel humidity
<b>High Temp Storage</b>	MIL-STD-750, M-1031, 1008 hours; 150°C
<b>Low-Temp Storage</b>	1008 hours; -40°C
<b>Thermal Shock</b>	MIL-STD-750, M-1056 10 cycles; 0°C to 100°C; 5-min dwell-time at each temperature; 10 sec (max) transfer time between temperature
<b>Autoclave</b>	EIA / JEDEC, JESD22-A102 168 hours (121°C at 2 ATMs) and 100% R/H
<b>Resistance to Solder Heat</b>	MIL-STD-750 Method 2031
<b>Solderability</b>	ANSI/J-STD-002, category 3, Test A
<b>Lead Bend</b>	MIL-STD-750, M-2036 Cond E

**Product Selector**

Part Number	Voltage				Gate Sensitivity	Type	Package
	400V	600V	800V	1000V			
Sxx10RS2	X	X			0.2mA	Sensitive SCR	TO-220R
Sxx10LS2	X	X			0.2mA	Sensitive SCR	TO-220L
Sxx10VS2	X	X			0.2mA	Sensitive SCR	TO-251
Sxx10DS2	X	X			0.2mA	Sensitive SCR	TO-252
Sxx10RS3	X	X			0.5mA	Sensitive SCR	TO-220R
Sxx10LS3	X	X			0.5mA	Sensitive SCR	TO-220L
Sxx10VS3	X	X			0.5mA	Sensitive SCR	TO-251
Sxx10DS3	X	X			0.5mA	Sensitive SCR	TO-252
Sxx10R	X	X	X	X	15mA	Standard SCR	TO-220R
Sxx10L	X	X	X	X	15mA	Standard SCR	TO-220L
Sxx10V	X	X	X	X	15mA	Standard SCR	TO-251
Sxx10D	X	X	X	X	15mA	Standard SCR	TO-252

Note: xx = Voltage

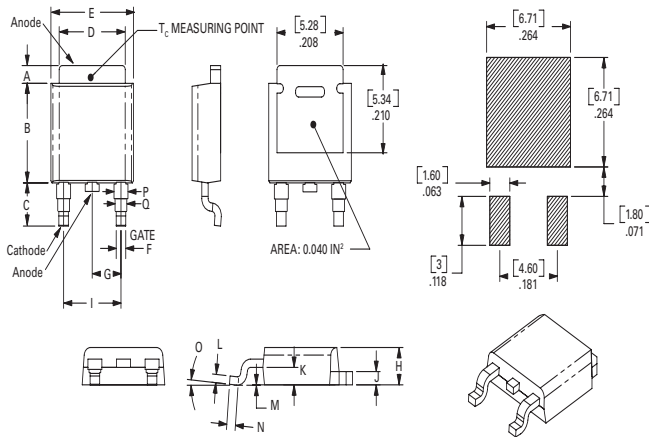
**Dimensions — TO-251AA (V/I-Package) — V/I-PAK Through Hole**



Dimension	Inches			Millimeters		
	Min	Typ	Max	Min	Typ	Max
A	0.040	0.044	0.050	1.02	1.11	1.27
B	0.235	0.242	0.245	5.97	6.15	6.22
C	0.350	0.361	0.375	8.89	9.18	9.53
D	0.205	0.208	0.213	5.21	5.29	5.41
E	0.255	0.262	0.265	6.48	6.66	6.73
F	0.027	0.031	0.033	0.69	0.80	0.84
G	0.087	0.090	0.093	2.21	2.28	2.36
H	0.085	0.092	0.095	2.16	2.34	2.41
I	0.176	0.180	0.184	4.47	4.57	4.67
J	0.018	0.020	0.023	0.46	0.51	0.58
K	0.038	0.040	0.044	0.97	1.01	1.12
L	0.018	0.020	0.023	0.46	0.52	0.58
P	0.042	0.047	0.052	1.06	1.20	1.32
Q	0.034	0.039	0.044	0.86	1.00	1.11
R	0.034	0.039	0.044	0.86	1.00	1.11
S	0.074	0.079	0.084	1.86	2.00	2.11



**Dimensions — TO-252AA (D-Package) — D-PAK Surface Mount**



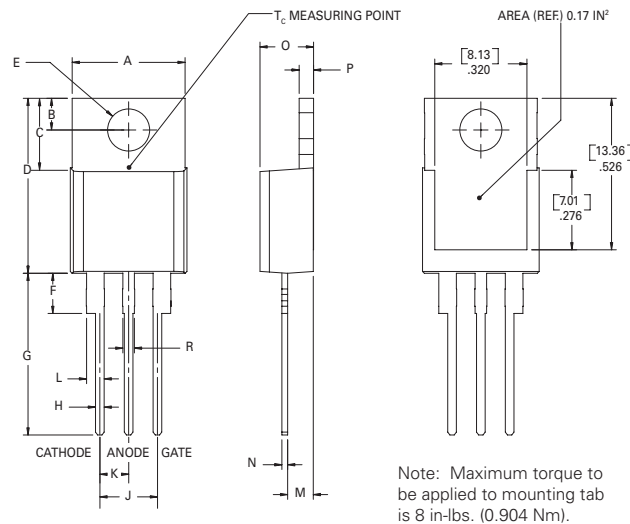
Dimension	Inches			Millimeters		
	Min	Typ	Max	Min	Typ	Max
A	0.040	0.043	0.050	1.02	1.09	1.27
B	0.235	0.243	0.245	5.97	6.16	6.22
C	0.106	0.108	0.113	2.69	2.74	2.87
D	0.205	0.208	0.213	5.21	5.29	5.41
E	0.255	0.262	0.265	6.48	6.65	6.73
F	0.027	0.031	0.033	0.69	0.80	0.84
G	0.087	0.090	0.093	2.21	2.28	2.36
H	0.085	0.092	0.095	2.16	2.33	2.41
I	0.176	0.179	0.184	4.47	4.55	4.67
J	0.018	0.020	0.023	0.46	0.51	0.58
K	0.038	0.040	0.044	0.97	1.02	1.12
L	0.018	0.020	0.023	0.46	0.51	0.58
M	0.000	0.000	0.004	0.00	0.00	0.10
N	0.021	0.026	0.027	0.53	0.67	0.69
O	0°	0°	5°	0°	0°	5°
P	0.042	0.047	0.052	1.06	1.20	1.32
Q	0.034	0.039	0.044	0.86	1.00	1.11

**Dimensions — TO-220AB (R-Package) — Non-Isolated Mounting Tab Common with Center Lead**



Dimension	Inches		Millimeters	
	Min	Max	Min	Max
A	0.380	0.420	9.65	10.67
B	0.105	0.115	2.67	2.92
C	0.230	0.250	5.84	6.35
D	0.590	0.620	14.99	15.75
E	0.142	0.147	3.61	3.73
F	0.110	0.130	2.79	3.30
G	0.540	0.575	13.72	14.61
H	0.025	0.035	0.64	0.89
J	0.195	0.205	4.95	5.21
K	0.095	0.105	2.41	2.67
L	0.060	0.075	1.52	1.91
M	0.085	0.095	2.16	2.41
N	0.018	0.024	0.46	0.61
O	0.178	0.188	4.52	4.78
P	0.045	0.060	1.14	1.52
R	0.038	0.048	0.97	1.22

**Dimensions — TO-220AB (L-Package) — Isolated Mounting Tab**



Dimension	Inches		Millimeters	
	Min	Max	Min	Max
A	0.380	0.420	9.65	10.67
B	0.105	0.115	2.67	2.92
C	0.230	0.250	5.84	6.35
D	0.590	0.620	14.99	15.75
E	0.142	0.147	3.61	3.73
F	0.110	0.130	2.79	3.30
G	0.540	0.575	13.72	14.61
H	0.025	0.035	0.64	0.89
J	0.195	0.205	4.95	5.21
K	0.095	0.105	2.41	2.67
L	0.060	0.075	1.52	1.91
M	0.085	0.095	2.16	2.41
N	0.018	0.024	0.46	0.61
O	0.178	0.188	4.52	4.78
P	0.045	0.060	1.14	1.52
R	0.038	0.048	0.97	1.22

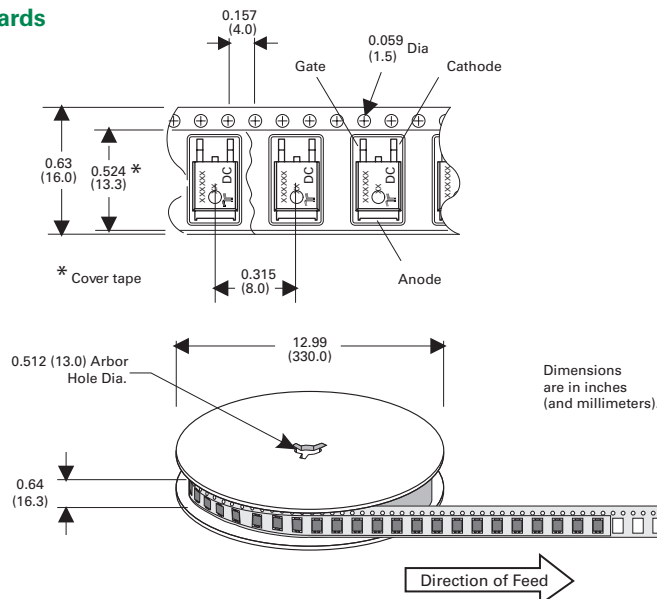
### Packing Options

Part Number	Marking	Weight	Packing Mode	Base Quantity
Sxx10L/Ryy	Sxx10L/Ryy	2.2 g	Bulk	500
Sxx10L/RyyTP	Sxx10L/Ryy	2.2 g	Tube	500 (50 per tube)
Sxx10DyyTP	Sxx10Dyy	0.3 g	Tube	750 (75 per tube)
Sxx10DyyRP	Sxx10Dyy	0.3 g	Embossed Carrier	2500
Sxx10VyyTP	Sxx10Vyy	0.4 g	Tube	750 (75 per tube)
Sxx10L/R	Sxx10L/R	2.2 g	Bulk	500
Sxx10L/RTP	Sxx10L/R	2.2 g	Tube	500 (50 per tube)
Sxx10DTP	Sxx10D	0.3 g	Tube	750 (75 per tube)
Sxx10DRP	Sxx10D	0.3 g	Embossed Carrier	2500
Sxx10VTP	Sxx10V	0.4 g	Tube	750 (75 per tube)

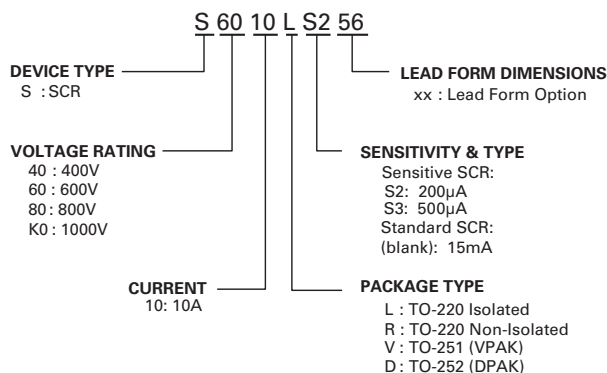
Note: xx = Voltage; yy = Sensitivity

### TO-252 Embossed Carrier Reel Pack (RP) Specifications

#### Meets all EIA-481-2 Standards



### Part Numbering System

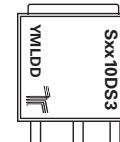


### Part Marking System

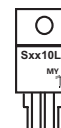
TO-220 AB – (R Package)



TO-251AA – (V Package)  
TO-252AA – (D Package)



TO-220 AB – (L Package)



## Данный компонент на территории Российской Федерации

### Вы можете приобрести в компании MosChip.

Для оперативного оформления запроса Вам необходимо перейти по данной ссылке:

<http://moschip.ru/get-element>

Вы можете разместить у нас заказ для любого Вашего проекта, будь то серийное производство или разработка единичного прибора.

В нашем ассортименте представлены ведущие мировые производители активных и пассивных электронных компонентов.

Нашей специализацией является поставка электронной компонентной базы двойного назначения, продукции таких производителей как XILINX, Intel (ex.ALTERA), Vicor, Microchip, Texas Instruments, Analog Devices, Mini-Circuits, Amphenol, Glenair.

Сотрудничество с глобальными дистрибьюторами электронных компонентов, предоставляет возможность заказывать и получать с международных складов практически любой перечень компонентов в оптимальные для Вас сроки.

На всех этапах разработки и производства наши партнеры могут получить квалифицированную поддержку опытных инженеров.

Система менеджмента качества компании отвечает требованиям в соответствии с ГОСТ Р ИСО 9001, ГОСТ РВ 0015-002 и ЭС РД 009

### Офис по работе с юридическими лицами:

105318, г.Москва, ул.Щербаковская д.3, офис 1107, 1118, ДЦ «Щербаковский»

Телефон: +7 495 668-12-70 (многоканальный)

Факс: +7 495 668-12-70 (доб.304)

E-mail: [info@moschip.ru](mailto:info@moschip.ru)

Skype отдела продаж:

moschip.ru

moschip.ru\_4

moschip.ru\_6

moschip.ru\_9