

1.225V micropower shunt voltage reference

Features

- 1.225V typical output voltage
- Ultra low operating current: 45µA maximum at 25°C
- High precision @ 25°C
 - +/- 2% (standard version)
 - +/- 1% (A grade)
 - +/- 0.5% (B grade)
- High stability when used with capacitive loads
- Industrial temperature range: -40°C to +85°C
- 120ppm/°C maximum temperature coefficient

Applications

- Computers
- Instrumentation
- Battery chargers
- Switch mode power supply
- Battery operated equipment

Description

The TS821 is a low power shunt voltage reference providing a stable 1.225V output voltage over the industrial temperature range (-40°C to +85°C). Available in SOT23-3 surface mount package, it can be designed in applications where space saving is critical.

The low operating current is a key advantage for power restricted designs. In addition, the TS821 is very stable and can be used in a broad range of application conditions.

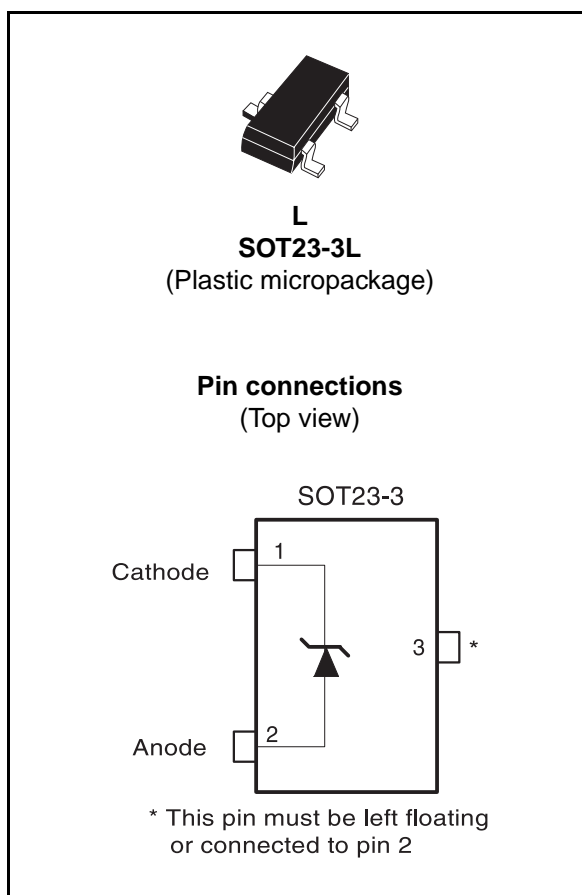

1 Absolute maximum ratings and operating conditions

Table 1. Absolute maximum ratings (AMR)

Symbol	Parameter	Value	Unit
I_k	Reverse breakdown current	20	mA
I_f	Forward current	10	mA
P_d	Power dissipation ⁽¹⁾ SOT23-3	360	mW
T_{stg}	Storage temperature	-65 to +150	°C
ESD	Human body model (HBM) ⁽²⁾	2	kV
	Machine model (MM) ⁽³⁾	200	V
T_{lead}	Lead temperature (soldering, 10 seconds)	260	°C

- P_d is calculated with $T_{amb} = 25^\circ\text{C}$ and $T_j = 150^\circ\text{C}$ and $R_{thja} = 340^\circ\text{C/W}$ for the SOT23-3L package.
- Human body model: 100pF discharged through a 1.5k Ω resistor between two pins of the device, done for all couples of pin combinations with other pins floating.
- Machine model: a 200pF cap is charged to the specified voltage, then discharged directly between two pins of the device with no external series resistor (internal resistor < 5 Ω), done for all couples of pin combinations with other pins floating.

Table 2. Operating conditions

Symbol	Parameter	Value	Unit
I_{min}	Minimum operating current	45	μA
I_{max}	Maximum operating current	12	mA
T_{oper}	Operating free air temperature range	-40 to +85	°C

2 Electrical characteristics

Table 3. TS821 (2% precision) $T_{amb} = 25^{\circ}\text{C}$ ⁽¹⁾ (unless otherwise specified)

Symbol	Parameter	Test conditions	Min.	Typ.	Max.	Unit
V_k	Reverse breakdown voltage	$I_k = 100\mu\text{A}$	1.200	1.225	1.250	V
	Reverse breakdown voltage tolerance	$I_k = 100\mu\text{A}$ $-40^{\circ}\text{C} < T_{amb} < +85^{\circ}\text{C}$	-25 +34		+25 +34	mV
I_{k-min}	Minimum operating current	$T_{amb} = 25^{\circ}\text{C}$		40	45	μA
		$-40^{\circ}\text{C} < T_{amb} < +85^{\circ}\text{C}$			50	
$\Delta V_{ref}/\Delta T$	Average temperature coefficient	$I_k = 100\mu\text{A}$			120	ppm/ $^{\circ}\text{C}$
$\Delta V_k/\Delta I_k$	Reverse breakdown voltage change with operating current range	$I_{k-min} < I_k < 1\text{mA}$ $-40^{\circ}\text{C} < T_{amb} < +85^{\circ}\text{C}$		0.3	0.7 1	mV
		$1\text{mA} < I_k < 12\text{mA}$ $-40^{\circ}\text{C} < T_{amb} < +85^{\circ}\text{C}$		2.5	8 10	
R_{ka}	Static impedance	$\Delta I_k = 45\mu\text{A}$ to 1mA		0.25	0.5	Ω
K_{vh}	Long term stability	$I_k = 100\mu\text{A}$, $t = 1000\text{hrs}$		120		ppm
En	Wide band noise	$I_k = 100\mu\text{A}$, $10\text{Hz} < f < 10\text{kHz}$		200		nV/ $\sqrt{\text{Hz}}$

1. Limits are 100% production tested at 25°C. Behavior at the temperature range limits is guaranteed through correlation and by design.

Table 4. TS821A (1% precision) $T_{amb} = 25^{\circ}\text{C}$ ⁽¹⁾ (unless otherwise specified)

Symbol	Parameter	Test conditions	Min.	Typ.	Max.	Unit
V_k	Reverse breakdown voltage	$I_k = 100\mu\text{A}$	1.213	1.225	1.237	V
	Reverse breakdown voltage tolerance	$I_k = 100\mu\text{A}$ $-40^{\circ}\text{C} < T_{amb} < +85^{\circ}\text{C}$	-12 -22		+12 +22	mV
I_{k-min}	Minimum operating current	$T_{amb} = 25^{\circ}\text{C}$		40	45	μA
		$-40^{\circ}\text{C} < T_{amb} < +85^{\circ}\text{C}$			50	
$\Delta V_{ref}/\Delta T$	Average temperature coefficient	$I_k = 100\mu\text{A}$			120	ppm/ $^{\circ}\text{C}$
$\Delta V_k/\Delta I_k$	Reverse breakdown voltage change with operating current range	$I_{k-min} < I_k < 1\text{mA}$ $-40^{\circ}\text{C} < T_{amb} < +85^{\circ}\text{C}$		0.3	0.7 1	mV
		$1\text{mA} < I_k < 12\text{mA}$ $-40^{\circ}\text{C} < T_{amb} < +85^{\circ}\text{C}$		2.5	5 7	
R_{ka}	Static impedance	$\Delta I_k = 45\mu\text{A}$ to 1mA		0.25	0.5	Ω
K_{vh}	Long term stability	$I_k = 100\mu\text{A}$, $t = 1000\text{hrs}$		120		ppm
En	Wide band noise	$I_k = 100\mu\text{A}$, $10\text{Hz} < f < 10\text{kHz}$		200		nV/ $\sqrt{\text{Hz}}$

1. Limits are 100% production tested at 25°C. Behavior at the temperature range limits is guaranteed through correlation and by design.

Table 5. TS821B (0.5% precision) $T_{amb} = 25^{\circ}\text{C}^{(1)}$ (unless otherwise specified)

Symbol	Parameter	Test conditions	Min.	Typ.	Max.	Unit
V_k	Reverse breakdown voltage	$I_k = 100\mu\text{A}$	1.219	1.225	1.231	V
	Reverse breakdown voltage tolerance	$I_k = 100\mu\text{A}$ $-40^{\circ}\text{C} < T_{amb} < +85^{\circ}\text{C}$	-6 -16		+6 +16	mV
I_{k-min}	Minimum operating current	$T_{amb} = 25^{\circ}\text{C}$		40	45	μA
		$-40^{\circ}\text{C} < T_{amb} < +85^{\circ}\text{C}$			50	
$\Delta V_{ref}/\Delta T$	Average temperature coefficient	$I_k = 100\mu\text{A}$			120	ppm/ $^{\circ}\text{C}$
$\Delta V_k/\Delta I_k$	Reverse breakdown voltage change with operating current range	$I_{k-min} < I_k < 1\text{mA}$ $-40^{\circ}\text{C} < T_{amb} < +85^{\circ}\text{C}$		0.3	0.7 1	mV
		$1\text{mA} < I_k < 12\text{mA}$ $-40^{\circ}\text{C} < T_{amb} < +85^{\circ}\text{C}$		2.5	5 7	
R_{ka}	Static impedance	$\Delta I_k = 45\mu\text{A}$ to 1mA		0.25	0.5	W
K_{vh}	Long term stability	$I_k = 100\mu\text{A}$, $t = 1000\text{hrs}$		120		ppm
E_n	Wide band noise	$I_k = 100\mu\text{A}$ $10\text{Hz} < f < 10\text{kHz}$		200		nV/ $\sqrt{\text{Hz}}$

1. Limits are 100% production tested at 25°C. Behavior at the temperature range limits is guaranteed through correlation and by design.

Figure 1. Reference voltage versus cathode current

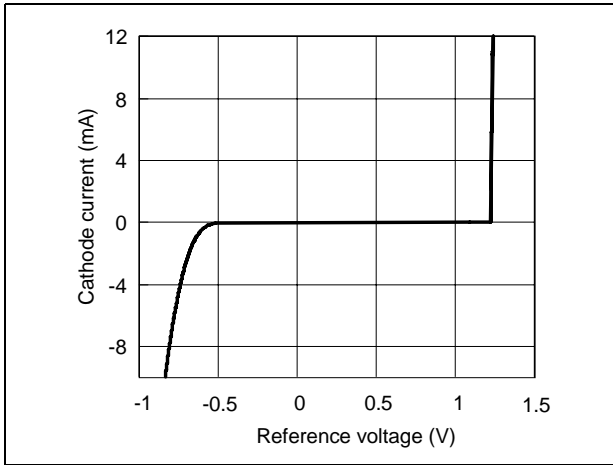

Figure 2. Reference voltage versus cathode current

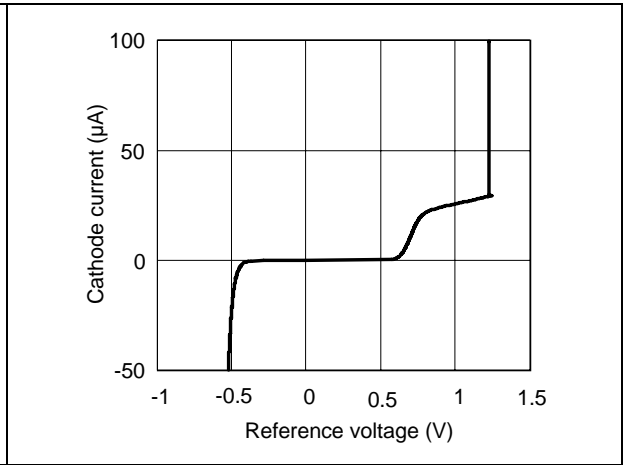

Figure 3. Test circuit

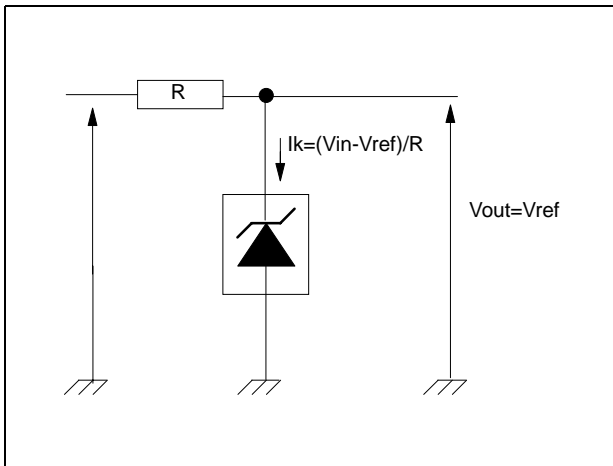

Figure 4. Reference voltage versus temperature

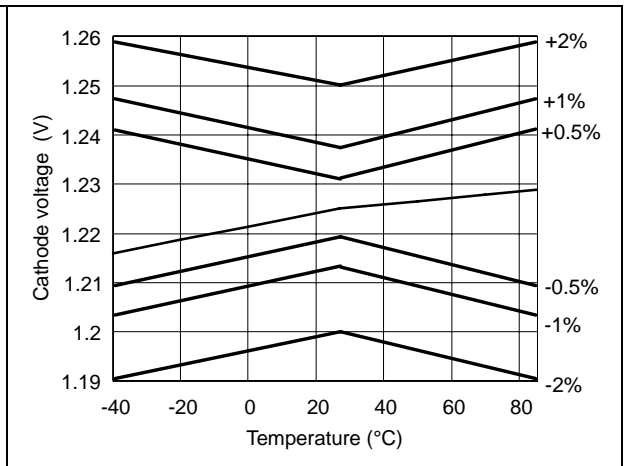

Figure 5. Static impedance versus temperature

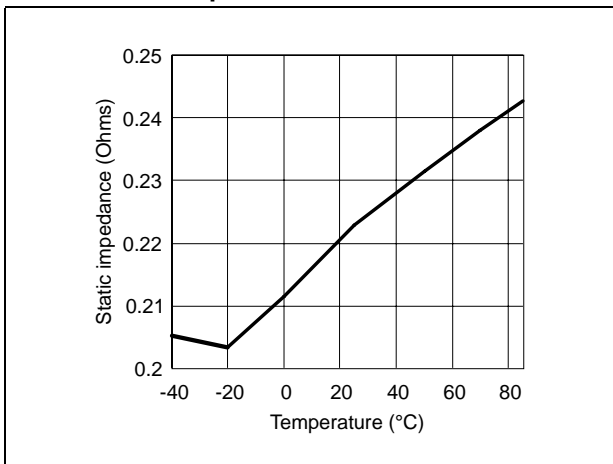

Figure 6. Noise voltage versus frequency

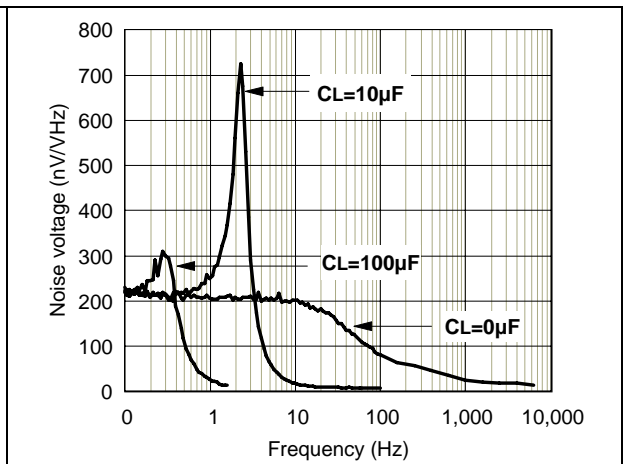

Figure 7. Pulse response for $I_k=100\mu A$



Figure 8. Test circuit for pulse response at $I_k=100\mu A$



Figure 9. Pulse response for $I_k=1mA$



Figure 10. Test circuit for pulse response at $I_k=1mA$

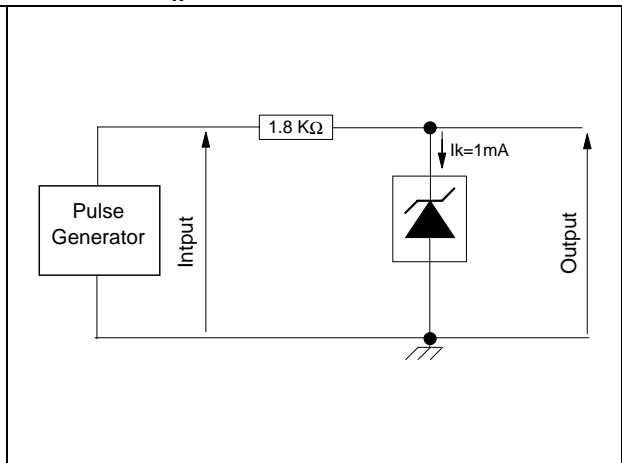

3 Package information

In order to meet environmental requirements, STMicroelectronics offers these devices in ECOPACK® packages. These packages have a lead-free second level interconnect. The category of second level interconnect is marked on the package and on the inner box label, in compliance with JEDEC Standard JESD97. The maximum ratings related to soldering conditions are also marked on the inner box label. ECOPACK is an STMicroelectronics trademark. ECOPACK specifications are available at: www.st.com.

Figure 11. SOT23-3 package mechanical data

Ref.	Dimensions					
	Millimeters			Mils		
	Min.	Typ.	Max.	Min.	Typ.	Max.
A	0.890		1.120	35.05		44.12
A1	0.010		0.100	0.39		3.94
A2	0.880	0.950	1.020	34.65	37.41	40.17
b	0.300		0.500	11.81		19.69
C	0.080		0.200	3.15		7.88
D	2.800	2.900	3.040	110.26	114.17	119.72
E	2.100		2.64	82.70		103.96
E1	1.200	1.300	1.400	47.26	51.19	55.13
e		0.950			37.41	
e1		1.900			74.82	
L	0.400		0.600	15.75		23.63
L1		0.540			21.27	
k	0°		8°	0°		8°



4 Ordering information

Table 6. Order codes

Part number	Precision	Temperature range	Package	Packing	Marking
TS821ILT	2%	-40°C to +85°C	SOT23-3	Tape & reel	L213
TS821AILT	1%				L212
TS821BILT	0.5%				L211

5 Revision history

Table 7. Document revision history

Date	Revision	Changes
10-Nov-2005	1	Initial release.
24-Jul-2007	2	Removed information related to TO-92. Format update.

Please Read Carefully:

Information in this document is provided solely in connection with ST products. STMicroelectronics NV and its subsidiaries ("ST") reserve the right to make changes, corrections, modifications or improvements, to this document, and the products and services described herein at any time, without notice.

All ST products are sold pursuant to ST's terms and conditions of sale.

Purchasers are solely responsible for the choice, selection and use of the ST products and services described herein, and ST assumes no liability whatsoever relating to the choice, selection or use of the ST products and services described herein.

No license, express or implied, by estoppel or otherwise, to any intellectual property rights is granted under this document. If any part of this document refers to any third party products or services it shall not be deemed a license grant by ST for the use of such third party products or services, or any intellectual property contained therein or considered as a warranty covering the use in any manner whatsoever of such third party products or services or any intellectual property contained therein.

UNLESS OTHERWISE SET FORTH IN ST'S TERMS AND CONDITIONS OF SALE ST DISCLAIMS ANY EXPRESS OR IMPLIED WARRANTY WITH RESPECT TO THE USE AND/OR SALE OF ST PRODUCTS INCLUDING WITHOUT LIMITATION IMPLIED WARRANTIES OF MERCHANTABILITY, FITNESS FOR A PARTICULAR PURPOSE (AND THEIR EQUIVALENTS UNDER THE LAWS OF ANY JURISDICTION), OR INFRINGEMENT OF ANY PATENT, COPYRIGHT OR OTHER INTELLECTUAL PROPERTY RIGHT.

UNLESS EXPRESSLY APPROVED IN WRITING BY AN AUTHORIZED ST REPRESENTATIVE, ST PRODUCTS ARE NOT RECOMMENDED, AUTHORIZED OR WARRANTED FOR USE IN MILITARY, AIR CRAFT, SPACE, LIFE SAVING, OR LIFE SUSTAINING APPLICATIONS, NOR IN PRODUCTS OR SYSTEMS WHERE FAILURE OR MALFUNCTION MAY RESULT IN PERSONAL INJURY, DEATH, OR SEVERE PROPERTY OR ENVIRONMENTAL DAMAGE. ST PRODUCTS WHICH ARE NOT SPECIFIED AS "AUTOMOTIVE GRADE" MAY ONLY BE USED IN AUTOMOTIVE APPLICATIONS AT USER'S OWN RISK.

Resale of ST products with provisions different from the statements and/or technical features set forth in this document shall immediately void any warranty granted by ST for the ST product or service described herein and shall not create or extend in any manner whatsoever, any liability of ST.

ST and the ST logo are trademarks or registered trademarks of ST in various countries.

Information in this document supersedes and replaces all information previously supplied.

The ST logo is a registered trademark of STMicroelectronics. All other names are the property of their respective owners.

© 2007 STMicroelectronics - All rights reserved

STMicroelectronics group of companies

Australia - Belgium - Brazil - Canada - China - Czech Republic - Finland - France - Germany - Hong Kong - India - Israel - Italy - Japan - Malaysia - Malta - Morocco - Singapore - Spain - Sweden - Switzerland - United Kingdom - United States of America

www.st.com



Данный компонент на территории Российской Федерации

Вы можете приобрести в компании MosChip.

Для оперативного оформления запроса Вам необходимо перейти по данной ссылке:

<http://moschip.ru/get-element>

Вы можете разместить у нас заказ для любого Вашего проекта, будь то серийное производство или разработка единичного прибора.

В нашем ассортименте представлены ведущие мировые производители активных и пассивных электронных компонентов.

Нашей специализацией является поставка электронной компонентной базы двойного назначения, продукции таких производителей как XILINX, Intel (ex.ALTERA), Vicor, Microchip, Texas Instruments, Analog Devices, Mini-Circuits, Amphenol, Glenair.

Сотрудничество с глобальными дистрибьюторами электронных компонентов, предоставляет возможность заказывать и получать с международных складов практически любой перечень компонентов в оптимальные для Вас сроки.

На всех этапах разработки и производства наши партнеры могут получить квалифицированную поддержку опытных инженеров.

Система менеджмента качества компании отвечает требованиям в соответствии с ГОСТ Р ИСО 9001, ГОСТ РВ 0015-002 и ЭС РД 009

Офис по работе с юридическими лицами:

105318, г.Москва, ул.Щербаковская д.3, офис 1107, 1118, ДЦ «Щербаковский»

Телефон: +7 495 668-12-70 (многоканальный)

Факс: +7 495 668-12-70 (доб.304)

E-mail: info@moschip.ru

Skype отдела продаж:

moschip.ru

moschip.ru_4

moschip.ru_6

moschip.ru_9